

gorenje

EN

GB

IE

**DETAILED INSTRUCTIONS
FOR USE OF A DRYER**

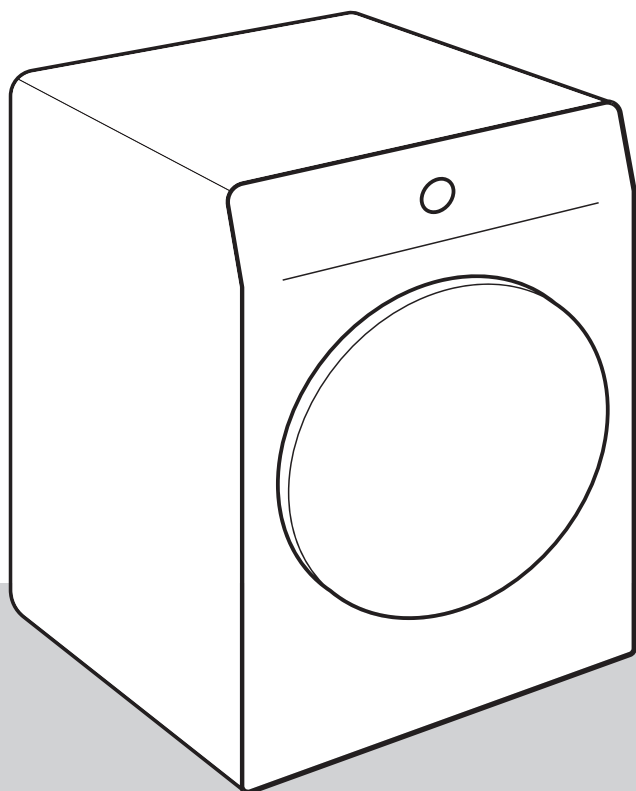

Life is complicated today. Let's make at least laundry care simple! Your new dryer uses innovative technology and the latest achievements in laundry care to help you simplify your daily household chores.

The technology offers the gentlest care for any garment, with minimum creasing. Moreover, your new dryer is also friendly to the environment as it uses power in the most economical way possible.

This dryer is intended solely for household use. Please do not use it to dry clothes that are not suitable for machine drying.

The following symbols are used throughout the manual and they have the following meanings:



INFORMATION!

Information, advice, tip, or recommendation



WARNING!

Warning – general danger



ELECTRIC SHOCK!

Warning – danger of electric shock



HOT SURFACE!

Warning – danger of hot surface



DANGER OF FIRE!

Warning – danger of fire



It is important that you carefully read the instructions.

Contents

SAFETY PRECAUTIONS	5
Danger of hot surface	11
Safety	12
DESCRIPTION OF THE DRYER	13
Technical data	14
Control unit	15
INSTALLATION AND CONNECTION	17
Selecting the room	17
Dryer placement	17
Adjusting the dryer feet	20
Draining the condensate	21
Connecting to the power mains	22
Moving and transport after installation	23
BEFORE USING THE APPLIANCE FOR THE FIRST TIME	24
Connecting the appliance to the ConnectLife application	25
DRYING PROCESS, STEP BY STEP (1 - 6)	28
Step 1: Heed the labels on the laundry	28
Step 2: Preparing for the laundry drying process	29
Switching on the dryer	30
Loading the dryer	31
Step 3: Choosing the drying programme	32
Program chart	33
DrySync function	34
Remote control of your dryer using the app	35
Step 4: Selecting extra functions	36
Step 5: Starting the drying programme	42
Step 6: End of the drying programme	42
INTERRUPTIONS AND CHANGING THE PROGRAMME	43
Interruptions	43
Changing the program/functions	43
Adding laundry after the start of the program	43
Saving personal settings	44
AdaptTech	44
Personal settings menu	44
CLEANING AND MAINTENANCE	45
Cleaning the door net filter in the door	46
Cleaning the heat pump filter	47
Cleaning of the heat exchanger	48
Emptying the condensate tank	49
Cleaning the dryer	50
TROUBLE-SHOOTING	51
What to do ...?	51
Troubleshooting and error table	51
Sounds	54
Service	55

TIPS FOR DRYING AND ECONOMIC USE YOUR DRYER	56
TYPICAL CONSUMPTION TABLE	57
9 kg	57
Low standby mode	58
PRODUCT ENERGY LABEL AND PRODUCT FICHE	59
DISPOSAL	61

SAFETY PRECAUTIONS



Carefully read the instructions for use before using the dryer.

Please, do not use the dryer without reading and understanding these instructions for use first.

This appliance is not intended for use by persons (including children) with reduced physical, sensory or mental capabilities, or lack of experience and knowledge, unless they have been given supervision or instruction concerning use of the appliance by a person responsible for their safety.

These instructions for use of a dryer are supplied with different types or models of dryers. Therefore, they may include descriptions of settings or equipment that are not available in your dryer.

The maximum mass of dry textile material in kilograms to be used in the appliance.

Failure to observe the instructions for use or inappropriate use of the dryer may result in damage to the laundry or the appliance, or injury to the user. Keep the instruction manual handy, near the dryer.

Instructions for use are available on our website at www.gorenje.com.

Your dryer is intended solely for household use. If the dryer is used for professional, for-profit purpose or purpose exceeding normal use in a household, or if the dryer is used by a person who is not a consumer, the warranty period shall be equal to the shortest warranty period required by relevant legislation.

Follow the instructions for correct installation of the Gorenje dryer and connection to the power mains (see chapter »INSTALLATION AND CONNECTION«).

All and any repairs or maintenance tasks on the dryer should only be done by trained experts. Unprofessional repair may result in an accident or major malfunction.

 **ELECTRIC SHOCK!**

To avoid danger, a **damaged power cord** may only be replaced by the manufacturer, a service technician, or an authorized person.

After installation, the dryer should stand still for two hours before it is connected to the power mains.

 **WARNING!**

Do not connect the dryer to power mains using an external switching device such as a programme timer, or connect it to power mains that is regularly switched on and off by the power supply provider.

The dryer shall not be connected to the power mains using an extension cord.

Do not connect the tumble dryer to an electrical outlet intended for an electric shaver or a hair dryer.

In case of a defect, only use approved spare parts by authorized manufacturers.

In case of incorrect dryer connection, incorrect use, or servicing by an unauthorized person, the user shall bear the cost of any damage as such damage shall not be covered by warranty.

Always use the hoses supplied with the dryer.

Install the dryer in a room with adequate ventilation and a temperature between 15°C and 25°C.

At least two persons are required to install the tumble dryer on top of a washing machine.

Place the dryer on a level and stable solid (concrete) base.

The appliance must not be installed behind a lockable door, a sliding door or a door with a hinge on the opposite side to that of the tumble dryer, in such a way that a full opening of the tumble dryer door is restricted.

Never block the air exhaust (evacuation opening).

For appliances with ventilation openings in the base, a carpet must not obstruct the openings.

The air in the room where the dryer is installed may not contain dust particles.

Adequate ventilation has to be provided to avoid the back flow of gases into the room from appliances burning other fuels, including open fires.

The lint must not to be allowed to accumulate around the tumble dryer.

In the appliance enclosure or in the built-in structure, keep ventilation openings clear of obstruction.

The appliance may not be in contact with a wall or adjacent furniture.

After installation, let the dryer rest still for 24 hours before using it. If the dryer has to be laid down on one of the sides during transport or servicing, place it with its left side, viewing from the appliance front, downwards.

Do not dry unwashed items in the tumble dryer.

Items that have been soiled with substances such as cooking oil, acetone, alcohol, petrol, kerosene, spot removers, turpentine, waxes and wax removers should be washed in hot water with an extra amount of detergent before being dried in the tumble dryer.

Items such as foam rubber (latex foam), shower caps, waterproof textiles, rubber backed articles and clothes or pillows fitted with foam rubber pads should not be dried in the tumble dryer.

Fabric softeners, or similar products, should be used as specified by the fabric softener instructions.

 **DANGER OF FIRE!**

Remove all objects from pockets such as lighters and matches.

If the condensate tube is blocked or clogged, then tumble dryer operation is stopped (see chapter »PAUSING AND CHANGING THE PROGRAMME/Full condensate tank«).

Before moving the dryer or before storing it in a non-heated room during the winter, the condensate tank has to be emptied.

That the lint trap has to be cleaned frequently, if applicable. Clean the dryer filters after each drying cycle. If you have removed the filters, replace them before the next drying cycle.

Do not use any solvents or cleaning agents that could damage the dryer (please observe the recommendations and warnings provided by the manufacturers of the cleaning agents).

Never add chemicals or fragrances into the condensate tank (see chapter »DESCRIPTION OF THE DRYER and EMPTYING THE CONDENSATE TANK«).

After the drying process, unplug the dryer power cord from the power outlet.

The dryer uses a heat pump system to heat the air.

The system consists of a compressor and a heat exchanger. When the dryer is started, compressor operation (the sound of flowing liquid) or flow of refrigerant may be louder as long as the compressor operates. This is not a sign of malfunction and it will not affect useful life of the dryer. In time and with use of the dryer this noise will become quieter.

The warranty does not cover consumables, minor deviations in colour, increased noise that results from appliance age and which does not affect the functionality of the dryer, and aesthetic defects on components, which do not affect the dryer's functionality and safety.

 **WARNING!**
Child safety

Children should be supervised to ensure that they do not play with the appliance.

Children of less than 3 years should be kept away unless continuously supervised.

Prevent your children and pets from entering the dryer drum.

Before closing the dryer door and running the programme, make sure there is nothing except laundry in the drum (e.g. if a child climbed into the dryer drum and closed the door from the inside).

Activate the Child lock. See chapter »STEP 4: SETTING THE EXTRA FUNCTIONS/Child lock«.

The dryer is made in compliance with all relevant safety standards.

This appliance can be used by children aged from 8 years and above and persons with reduced physical, sensory or mental capabilities or lack of experience and knowledge if they have been given supervision or instruction concerning use of the appliance in a safe way and understand the hazards involved.

Children shall not play with the appliance.

Cleaning and user maintenance shall not be made by children without supervision.

Danger of hot surface



HOT SURFACE!

At higher drying temperatures, the door glass will heat up. Be careful to avoid burns. Make sure children do not play near the door glass.

The back of the dryer may get very hot during operation. Wait for the dryer to cool down completely before touching its back side.

If you open the dryer door during the drying process, the clothes may be very hot and there is a risk of burning.

Never stop the drying process before it is completed; if you do interrupt the cycle for any reason, be careful when removing the laundry from the drum as it is very hot. Quickly remove the laundry from the drum and spread it to allow it to cool down as quickly as possible.

Safety

DANGER OF FIRE!

Only use the dryer to dry laundry that was washed with water. Do not dry any laundry that was washed or cleaned with flammable cleaners or substances (such as gasoline, trichloroethylene etc.) as this may result in an explosion.

The tumble dryer is **not to be used** if industrial chemicals have been used for cleaning.

The dryer is protected with an automatic switch-off system in case of overheating. This system will switch off the dryer if the temperature is too high.

If the net filter is clogged, the overheating automatic switch-off system may be activated. Clean the filter, wait for the dryer to cool down, and try running it again. If the dryer still fails to start, call a service technician.

Do not damage the refrigerant circuit.

The refrigerant R290 in this appliance is environmentally friendly yet combustible and may ignite if it comes into contact with open flames or ignition sources. Keep naked flames and ignition sources away from the appliance.

DESCRIPTION OF THE DRYER

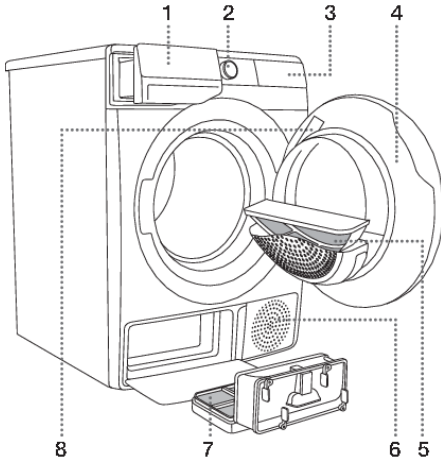

FRONT

1. Condensate tank
2. Dryer on/off and program selector knob
3. Touch control unit
4. Door
5. Net filter
6. Air vent
7. Heat pump filter
8. Rating plate

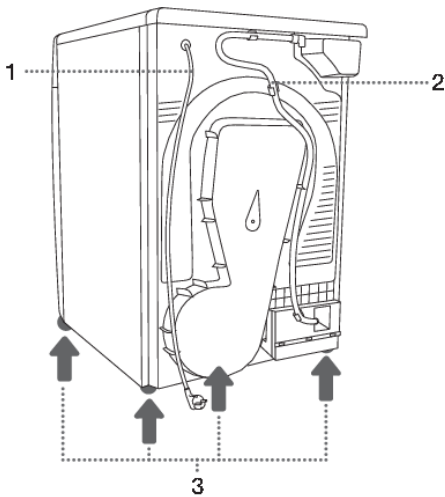

BACK

1. Power cord
2. Condensate discharge hose
3. Adjustable feet

Technical data

(depending on the model)

Rating plate with basic information about the dryer is located on the inner side of the dryer door (see chapter »DESCRIPTION OF THE DRYER«).

Width	600 mm
Height	850 mm
Dryer depth (a)	625 mm
Depth with door closed	653 mm
Depth with door open (b)	1134 mm
Weight	XX/YY kg (depending on the model)
Rated voltage	See rating plate
Fuse	See rating plate
Nominal power	See rating plate
Quantity of refrigerant	See rating plate
Type of refrigerant	R290
Maximum load	See rating plate

Rating plate



TYPE:SP22/XXXXX MODEL:XXXXXXXXXXXXX

ART.No.:XXXXXX/XX Ser.No.:XXXXXXXX IPX4

XXX-XXX V ~ XX Hz ≡ XX A ○ XX kg

Pmax.XXXX W RXXX /XXXX kg



 GORENJE
 gospodinjstvi aparati d.o.o.
 Partizanska cesta 12
 SI-8320 Velenje, SLOVENIA
 info@gorenje.com





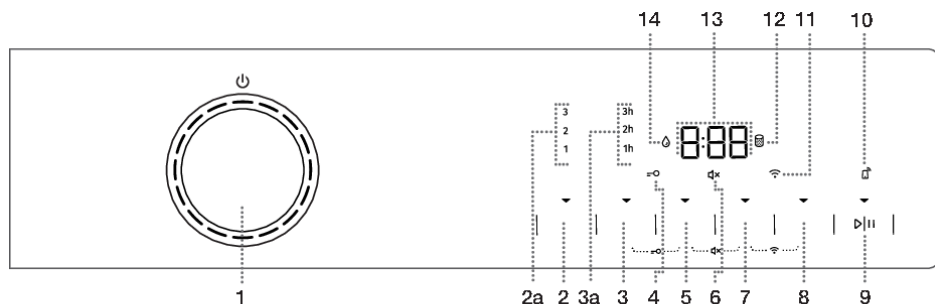

AUID:XXXXXXXXXXXXXXXXXXXXXXXXXXXXXXXXXXXX



MADE IN SLOVENIA

Control unit



- 1** Dryer **ON/OFF**  and PROGRAM SELECTOR KNOB.
To **TURN ON** the dryer, rotate the program selector knob in either direction.
To **TURN OFF** the dryer, rotate the program selector knob to position OFF .
- To **SELECT** a drying program, rotate the knob in either direction. The indicator light next to the selected program lights up.
- 2** **EXTRA DRY** (DRYNESS LEVEL)
The symbol is lit when the function is selected. Extra functions 2a (1, 2, 3) allow selecting a higher dryness level and extend the drying time.
- 3** **ANTI CREASE** (CREASE PREVENTION)
The selected operating time of the function will light up.
- 3+5** **Child lock ON/OFF**
Press the positions 3+5 and hold them for 3 seconds.
- 4** **CHILD LOCK** symbol  lighting
- 5** **TIME DRY** (TIMED DRYING)
Option to set the drying time.
- 6** Illumination of the **SOUND OFF** symbol 
- 7** **DELAY END** (DELAYING THE END OF THE DRYING PROGRAM)
Option to set the time when the drying will end.
- 5+7** **Sound ON/OFF**
Press the positions 5+7 and hold them for 3 seconds.
- 8** **NATURE DRY**  (LOWER TEMPERATURE)
Option to dry at a lower temperature.
- 7+8** **SWITCHING ON/OFF the Wi-Fi connection** 
Press the positions 7+8 and hold them for 3 seconds.

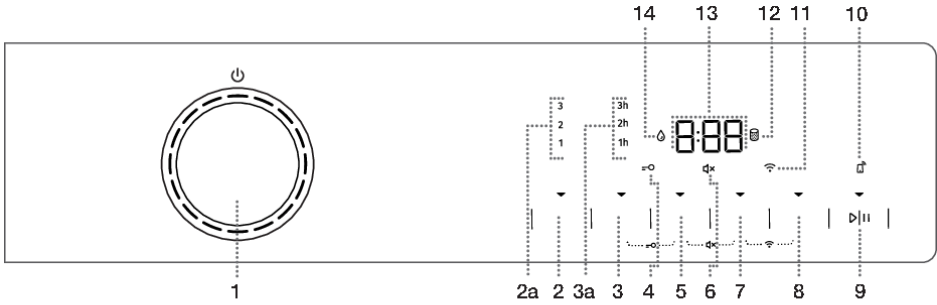

9 START/PAUSE BUTTON ▷||

The button has 4 functions:

- **START** – starting the drying programme (start the programme with a brief press on the button);
- **PAUSE** – pause the drying programme (briefly press the button again to temporarily stop appliance operation);
- **SAVING PERSONAL SETTINGS** (hold the key for 3 seconds).
- Activating **REMOTE START**

When the appliance is turned on, the indicator on the button lights up.

10 Lighting of the symbol **REMOTE START** ▷

11 Lighting of the symbol **CONNECT** (CONNECTION)

12 Lighting of the symbol **CLEAN THE FILTER**

13 The following is displayed on the **DISPLAY UNIT**:

- Available functions;
- Time remaining to programme completion;
- Information for the user.

14 Lighting of the symbol **EMPTY THE CONDENSATE TANK**

INSTALLATION AND CONNECTION



INFORMATION!

Remove all packaging. When removing the packaging, make sure not to damage the dryer with a sharp object.

Selecting the room

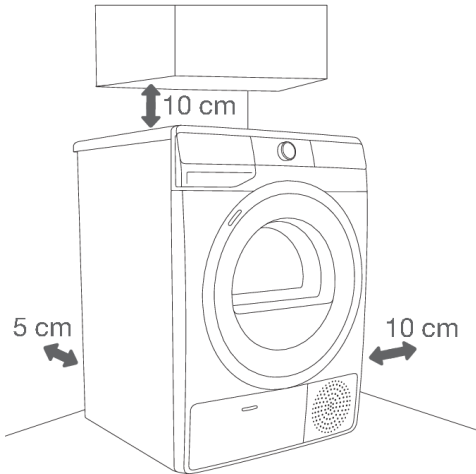

INFORMATION!

The dryer may not be in contact with a wall or adjacent furniture. For optimum dryer operation, we recommend observing the clearance from the walls as indicated in the figure. In case of failure to heed the required minimum clearance, the dryer may overheat.



INFORMATION!

Vents on the back wall and the air exhaust opening on the front side of the dryer should never be obstructed.

The room in which you will install the dryer should be sufficiently ventilated, with a temperature between 15°C and 25°C. Dryer operation at a lower environment temperature may result in condensate accumulation in the dryer interior. Do not place the dryer into a place where there is danger of freezing. Frozen water in the condensate tank and pump may damage the dryer.

The dryer emits heat. Therefore, do not place it in a very small room, as the drying process may take longer due to limited amount of available air.

Lighting in the room should be sufficient to allow reading the information on the display unit on the control panel.

Dryer placement

If you also have a Gorenje dryer of corresponding (same) dimensions, it can be placed on top of the Gorenje washing machine; in this case, vacuum feet must be used and wall fixing bracket. Alternatively, the dryer can be placed next to the washing machine (figures 1 and 3).

If your Gorenje washing machine is smaller (minimum depth 545 mm), than your Gorenje dryer, then the dryer support has to be purchased extra (figure 2). The supplied vacuum feet must be used; they are designed to prevent the dryer from slipping.

Additional equipment: tumble dryer bracket (a), vacuum feet (b) (if not supplied) and wall fixing bracket (c), can be purchased at the service centre.

The surface on which the appliance is placed should be clean and level.

Gorenje washing machine onto which you intend to place the Gorenje dryer should hold the weight of the Gorenje dryer (see chapter »WASHING MACHINE DESCRIPTION/Technical information«).

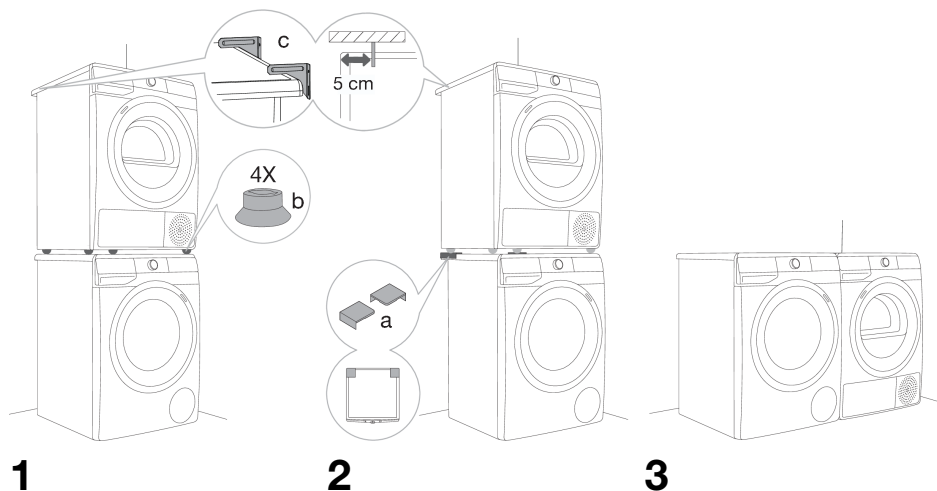

⚡ INFORMATION!

At least two persons are required to install the tumble dryer on top of a washing machine.

Opening the dryer door (top view)

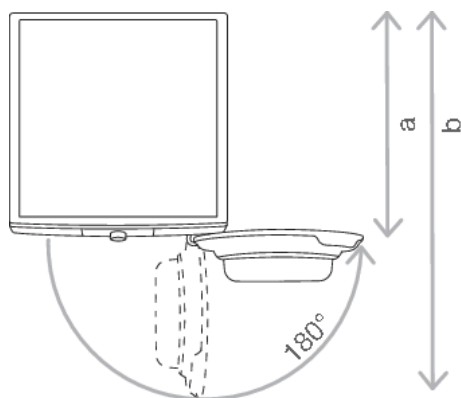

See chapter »DESCRIPTION OF THE DRYER/Technical information«.

a = 625 mm
b = 1134 mm

⚠ WARNING!

The appliance must not be installed behind a lockable door, a sliding door or a door with a hinge on the opposite side to that of the tumble dryer, in such a way that a full opening of the tumble dryer door is restricted.

⚠ WARNING!

For appliances with ventilation openings in the base, a carpet must not obstruct the openings.

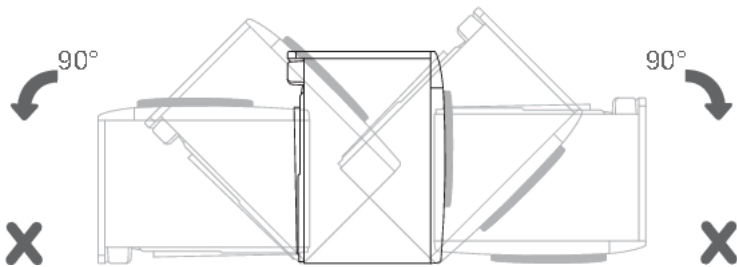
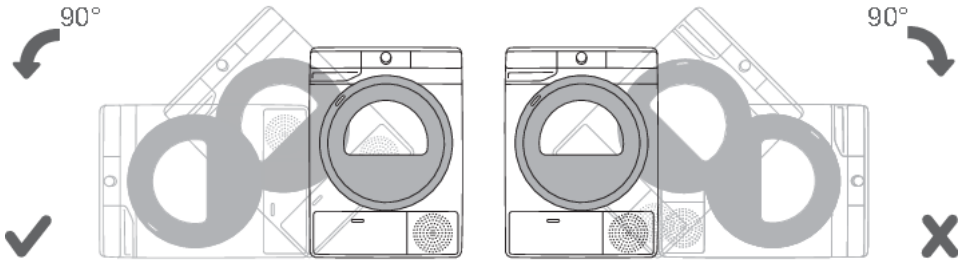

💡 INFORMATION!

After installation, wait for 24 hours without moving the appliance before using it for the first time. If the dryer has to be laid down on one of the sides during transport or servicing, place it with its left side, viewing from the appliance front, downwards.

Adjusting the dryer feet

Level the dryer in longitudinal and traverse direction by rotating the adjustable feet which allow levelling by +/- 1 cm. Use a spirit level and spanner No. 22.

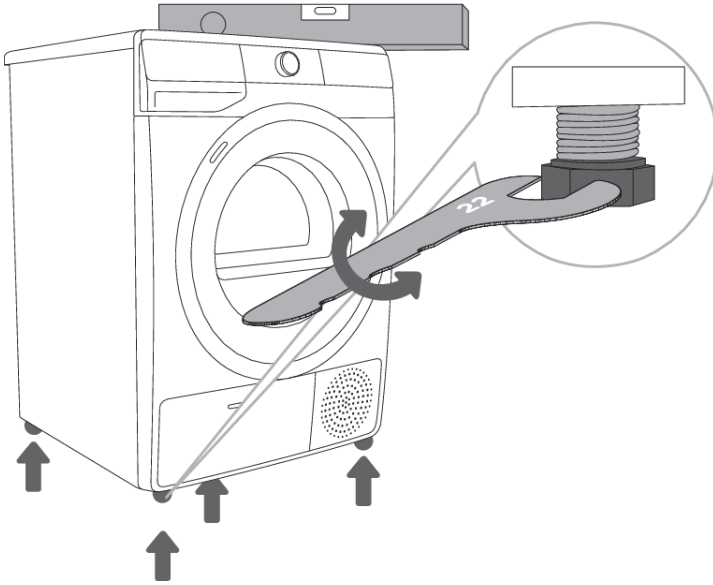

-💡- INFORMATION!
Floor on which the dryer is placed must have a concrete base. It should be clean and dry; otherwise, the dryer may slide. Also clean the adjustable feet.

-💡- INFORMATION!
The dryer must stand level and stable on a solid base.

-💡- INFORMATION!
Incorrect levelling of the dryer with the adjustable legs may cause vibration, appliance sliding across the room, and loud operation. Incorrect levelling of the dryer shall not be subject to warranty.

-💡- INFORMATION!
Sometimes, unusual or louder noise may appear during appliance operation; these are mostly the result of improper installation.

Draining the condensate

During the drying process, an indicator light (symbol  (14), is lit on the display unit) warns when the condensate tank is full and needs to be emptied.

To avoid emptying the condensate tank, run the condensate discharge hose located at the back of the appliance directly into a drain.

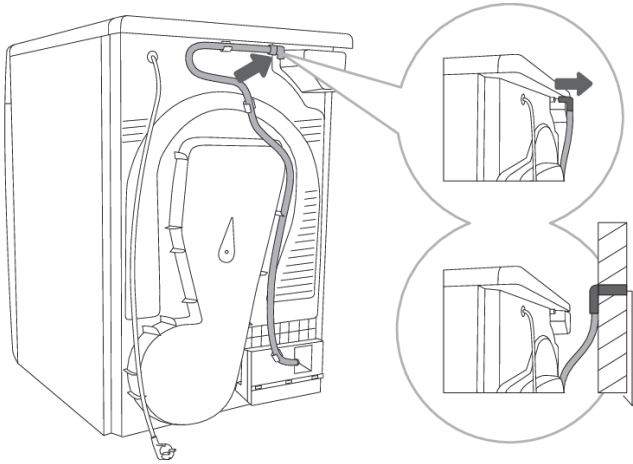

1 Release the hose from the holder on the back wall of the dryer (left hand side, below the top cover).

2 Run the hose into a drain at a height of no more than 80 cm from the floor.



INFORMATION!

If you decide to run the condensate drain hose into a drain, make sure the hose is securely fastened. This will prevent any water spillage which could result in unexpected damage.



WARNING!

Always use the hoses supplied with the dryer.

Connecting to the power mains

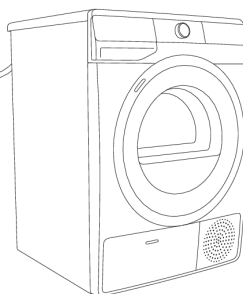
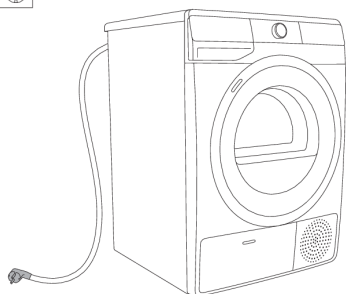

ELECTRIC SHOCK!

After installation, the dryer should stand still for two hours before it is connected to the power mains; this allows the dryer to stabilize.

Connect the dryer to a grounded power outlet. After installation, the wall outlet should be freely accessible. The outlet should be fitted with an earth contact (in compliance with the relevant regulations).

Information on your dryer is indicated on the rating plate (see chapter »DESCRIPTION OF THE DRYER/Technical information«).



ELECTRIC SHOCK!

We recommend using over-voltage protection to protect the appliance in case of a lightning strike.



WARNING!

The dryer shall not be connected to the power mains using an extension cord.



INFORMATION!

Do not connect the tumble dryer to an electrical outlet intended for an electric shaver or a hair dryer.



INFORMATION!

Any repair and maintenance pertaining to safety or performance should be done by trained experts.



INFORMATION!

A damaged power cord may only be replaced by a person authorized by the manufacturer.

Moving and transport after installation

After every drying cycle, a small amount of condensed water will remain in the dryer. Switch on the dryer and choose one of the programmes, then let the appliance operate for approximately half a minute. This will pump out the remaining water and prevent damage to the dryer during transport.

If the dryer cannot be transported in the upright position, tilt it to the left side.



ELECTRIC SHOCK!

After transport, the dryer should be left to stand still for at least two hours before it is connected to the power mains. The appliance should be installed and connected by a trained technician.



INFORMATION!

If the appliance was not transported in compliance with the instructions, the dryer should be left to stand still at least 24 hours before it is reconnected to the power mains.

Failure to do so may result in a heat pump failure which shall not be covered by the warranty.

Be careful not to damage the cooling system (see chapter »INSTALLATION AND CONNECTION/Dryer placement«).



ELECTRIC SHOCK!

Carefully read the instructions for use before connecting the dryer. Repair or any warranty claim resulting from incorrect connection or use of the dryer shall not be covered by the warranty.



INFORMATION!

The belt may only be replaced by a service technician authorized by the manufacturer, who can supply the original spare part with the code OPTIBELT EPH 1906, code 104265; OPTIBELT 8 EPH 1941, code 160165; POLY-V 7PH 1956 HUTCHINSON, code 562038; HUTCHINSON 8 PHE 1942, code 270313 (depending on the model).

BEFORE USING THE APPLIANCE FOR THE FIRST TIME

Make sure the dryer is disconnected from the power mains; then, open the door by pulling the left side of the door towards you (figures 1 and 2).

Before using the dryer for the first time, clean the dryer drum using a soft damp cotton cloth and water (figure 3).

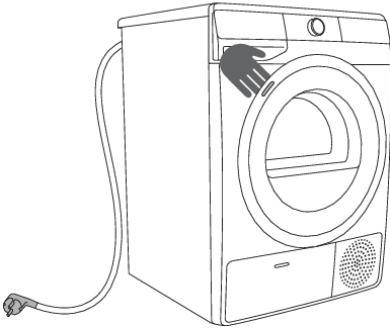

1

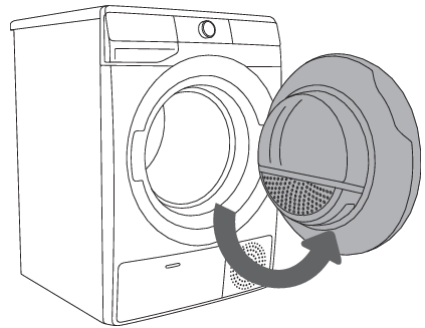

2

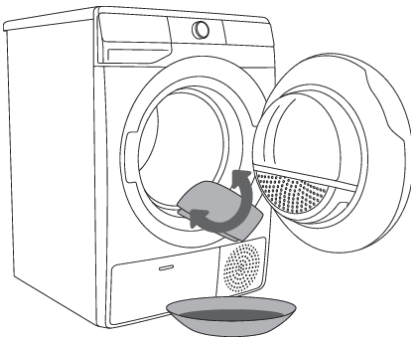

3



WARNING!

Do not use any solvents or cleaning agents that could damage the dryer (please observe the recommendations and warnings provided by the manufacturers of the cleaning agents).

Connecting the appliance to the ConnectLife application

ConnectLife is a smart home platform that connects people, devices and services. The **ConnectLife** application includes advanced digital services and carefree solutions that allow users to monitor and control appliances, receive notifications from a smartphone, and update software (supported features may vary depending on your appliance and the region/country in which you are located).

To connect your smart device, you need a home Wi-Fi network (only 2.4 GHz networks are supported) and a smartphone equipped with the application **ConnectLife**.



To download the **ConnectLife** application, scan the QR code or search for **ConnectLife** in your favourite app store.

1. Install the **ConnectLife** application and create an account.
2. In the **ConnectLife** application, go to the »Add device« menu and select the appropriate type of device. Then scan the QR code (it can be found on the nameplate of the appliance; you can also enter the AUID/SN number manually).
3. The application then guides you through the entire process of connecting the appliance to your smartphone.
4. After a successful connection, the appliance can be operated remotely via the mobile application.

Useful tips for your smart device

Where to find the QR code for the devices required by the app during the installation process?

The QR code can be found on the warranty card and on the rating plate of the appliance.

How to enable Wi-Fi on the device?

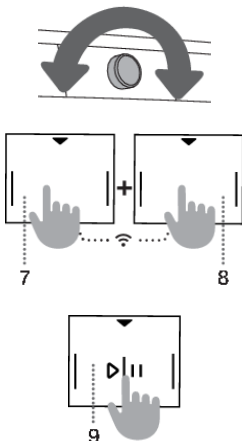

Check that the appliance is switched on; the programme selection button can be in any position. Then do the following:

- In the **ConnectLife** app, open the add device menu.
- Follow the instructions in the application **ConnectLife**, where you will pair your phone and appliance and add the appliance to your home Wi-Fi network.
 - Select the type of appliance.
 - Scan the QR code (it can be found on the warranty card or on the rating plate of the appliance).
- On the appliance:
 - Simultaneously press the positions (7+8). A countdown will start 3-2-1 and **OFF** will appear on the appliance.
 - Press the button (8) to switch on Wi-Fi; the display will show **On**.
 - Press the button (9) START/PAUSE ▷||. The display will show **Con**.

- Press again the button (9) START/PAUSE ▷||. A 5-minute countdown will begin on the appliance.
- In the **ConnectLife** app, instructions will guide you through the process of entering the appropriate data for your appliance to connect to your home network.



How to enable remote start of the appliance?

Move the programme selection button to **ConnectLife/REMOTE CONTROL** (remote control).

Press the (9) START/PAUSE button (the door must be closed).

How to add a user?



Check that the appliance is switched on; the programme selection button can be in any position. Then do the following:

- In the **ConnectLife** app, open the add device menu.
- Follow the instructions in the application **ConnectLife** where you will pair the phone and the appliance.
 - Select the type of appliance.
 - Scan the QR code (it can be found on the warranty card or on the rating plate of the appliance).
- On the appliance:
 - Simultaneously press the positions (7+8). A countdown will start 3-2-1 and  will appear on the appliance.
 - Press the button (8); the display will show .
 - Press the button (9) START/PAUSE ▷||. A 3-minute countdown will start on the appliance.
- You can then complete and confirm the setting in the app.

How to remove the users (UnPair)?

Check that the appliance is switched on; the programme selection button can be in any position. Then do the following:

On the appliance:

- Simultaneously press the positions (7+8). A countdown will start 3-2-1 and  will appear on the appliance.
- Repeatedly press (8); until the display shows .
- Press the button (9) START/PAUSE ▷||. A 1-minute countdown will start on the appliance.

INFORMATION!

This step will remove all active users of the appliance. If you want to operate the appliance remotely again, you will need to repeat the process of adding a user .

Which Wi-Fi router can be used?

Only 2,4 GHz networks are supported. If the **ConnectLife** app cannot find your local network during the connection set-up process, check the following:

- your router is operating at the frequency of 2.4 GHz,
- your network is hidden, and
- your signal is strong enough.

Do you have more questions?























Please visit us at www.connectlife.io or contact us at hello@connectlife.io.

Remotely upgrading the software

Check the software update options in the app **ConnectLife**.

DRYING PROCESS, STEP BY STEP (1 - 6)

Step 1: Heed the labels on the laundry

Normal wash; Sensitive laundry			
	Max. washing temp. 95°C		Max. washing temp. 40°C
	Hand wash only		
	Max. washing temp. 60°C		Max. washing temp. 30°C
	Do not wash		
Bleaching			
	Bleaching in cool water		Bleaching not allowed
Dry cleaning			
	Dry cleaning with all agents		Petroleum solvent R11, R113
	Dry cleaning in kerosene, pure alcohol, and R113		Dry cleaning not allowed
Ironing			
	Hot ironing, max. 200°C		Hot ironing, max. 110°C
	Hot ironing, max. 150°C		Ironing not allowed
Drying			
	Dry flat (place on a flat surface)		High temperature
	Drip dry		Low temperature
	Line dry		Tumble drying not allowed

Step 2: Preparing for the laundry drying process

1. Sort the laundry by type and thickness of the fabric (see PROGRAMME TABLE).
2. Close the buttons and zips, tie any ribbons, and turn the pockets inside out.
3. Place very sensitive clothes in a special-purpose laundry bag.
(The special-purpose laundry bag is available as an optional accessory.)

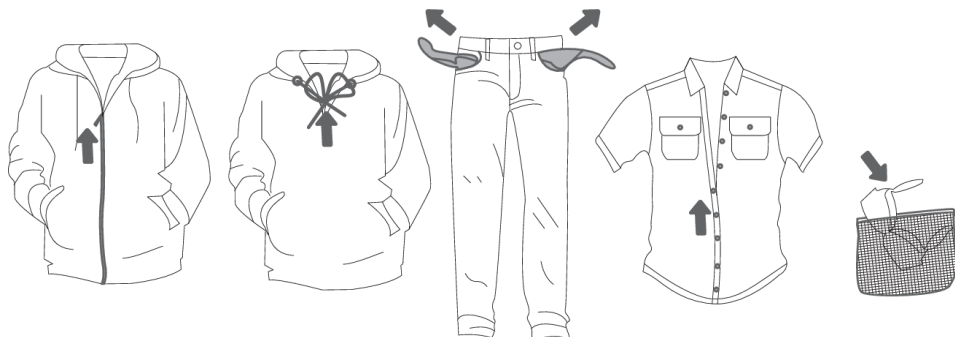

Drying laundry made of particularly delicate fabrics that may be deformed is not recommended. The following types of laundry may not be dried in the dryer as this may cause your garments to deform:

- **leather garments and other leather products,**
- **garments that are waxed or treated in any other way,**
- **garments with major wooden, plastic, or metal parts;**
- **garments with spangles;**
- **garments with metal parts subject to rusting.**

Switching on the dryer

Connect the dryer to the power mains by plugging in the power cord.

To turn on the dryer, rotate the program selector knob (1) to any position (figure 1).

With some models, the dryer drum is lit as well (figure 2).

(The light in the dryer drum is not suitable for any other use.)



INFORMATION!

The light in the dryer drum may only be replaced by the manufacturer, a service technician or an authorized person.

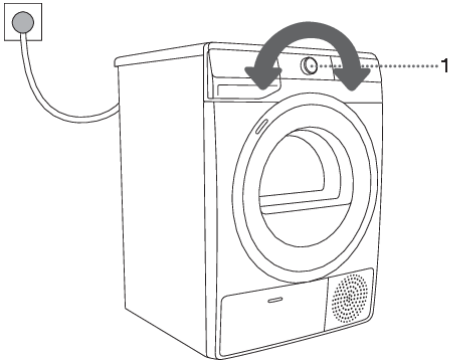

1

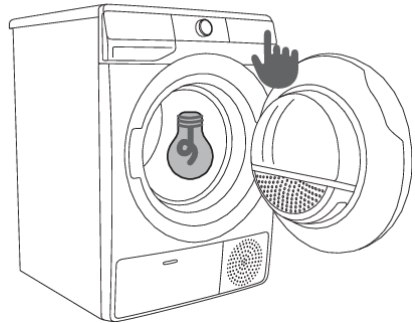

2

Loading the dryer

Open the dryer door by pulling the left side of the door towards you (figure 1).

Insert the laundry into the drum (after making sure the drum is empty) (figure 2).

Close the dryer door (figure 3).

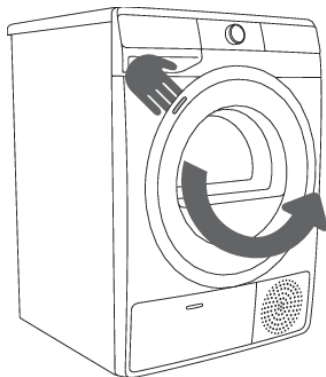

1

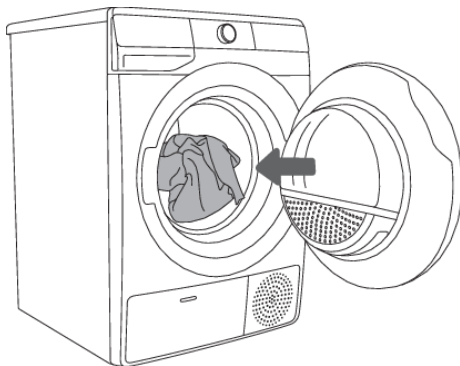

2

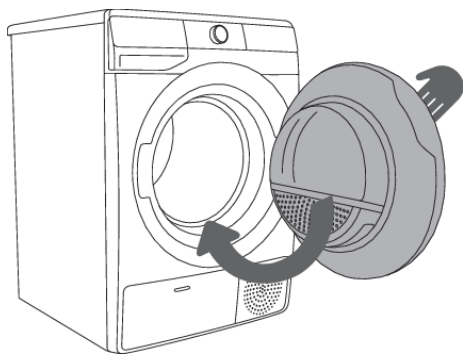

3



INFORMATION!

Do not insert laundry into the dryer if it has not been wrung or spun (recommended minimum spinning cycle: 800 rpm).

Do not overload the drum! See PROGRAMME TABLE and observe your nominal load as indicated on the rating plate.

If the dryer drum is overloaded, the laundry will be more wrinkled and perhaps unevenly dried.



INFORMATION!

When drying larger items (bedding, towels, tablecloths etc.), loosen them and then insert them into the dryer drum.

Step 3: Choosing the drying programme

Select the **programme** by rotating the programme selector knob (1) in either direction (depending on the type of laundry and the desired level of dryness). See PROGRAMME TABLE.



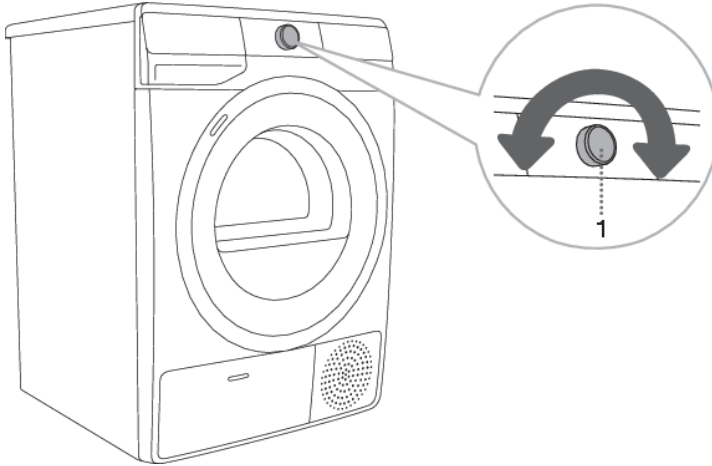











The signal light next to the selected program lights up.









INFORMATION!

The programme selector knob (1) will not rotate automatically during operation.

Program chart

Program Dryness levels		Max. load	Programme description
Cotton (Cotton)			
	Storage (Cupboard dry)	9 kg	Use this programme for thicker non-sensitive cotton laundry. After drying, it will be dry and ready to be stored in the cupboard.
	Standard* □	9 kg	Use this programme for thicker non-sensitive cotton laundry of approximately the same thickness. After drying, it will be dry.
	Iron (Moist for ironing)	9 kg	Use this program for non-sensitive cotton laundry. After drying, it will be ready for ironing.
	Mix (Mixed laundry)	3,5 kg	The program is used for drying cotton and synthetic laundry at the same time. NATUREDRY  drying at a lower temperature that is friendlier to your laundry.
	Synthetic (Synthetics)	3,5 kg	The program is used for drying synthetic and blended textiles.
	Wool (Wool)	2 kg	This short program is intended for softening or fluffing of clothes made of wool and silk, which have to be dried thoroughly according to manufacturer's instructions.
	Bedding (Bedding)	5 kg	Use this programme for larger items. When the programme is complete, they will be dry. Adjusted drum rotation prevents the laundry from tangling.
	Time (Timed program)	4 kg	Use this programme for non-sensitive laundry that is still slightly moist and has to be thoroughly dried. In the time programme, remaining moisture is not detected automatically. If the laundry is still damp after the programme is complete, repeat the programme; if it is too dry and therefore creased and rough to touch, the drying time you selected was too long.
	Baby (Baby clothes)	4 kg	Use this programme to dry baby clothes. Clothes dried with this programme are usually normally dry. NATUREDRY  drying at a lower temperature that is friendlier to your laundry.
	Sensitive (Delicate)	1 kg	Use this programme to dry highly delicate laundry made of synthetic fibres, which may be slightly moist after the drying process. We recommend using a special-purpose laundry bag. NATUREDRY  drying at a lower temperature that is friendlier to your laundry.
	Shirts (Shirts)	2 kg	Use this program to dry shirts and blouses. Adjusted drum rotation prevents the laundry from creasing. NATUREDRY  drying at a lower temperature that is friendlier to your laundry.

Program Dryness levels	Max. load	Programme description
 Sports  (Sportswear)	3 kg	Use this programme for clothing with a membrane, for sportswear made of mixed materials, and breathable fabrics. NATUREDRY  drying at a lower temperature that is friendlier to your laundry.
 Fast 89' (Fast 89')	4 kg	The program is suitable for smaller amounts of laundry that you wish to dry quickly and efficiently.
 Extra Hygiene	4 kg	Longer drying program duration and overheating of the fabric results in higher drying temperature (above 60 °C), which reduces the amount of microbes and allergens on the garments. This drying program should not be used for delicate items and items that are not suitable for machine drying.
 Remote control (Remote control)		Use the Remote control programme to remotely control your appliance (using your phone). You can select all programs available of your appliance (see chapters »BEFORE FIRST USE/Setting up the first connection of your appliance to the Wi-Fi network« and »WASHING STEPS /1–6/ Step 3: Remote control of your dryer using the app«).

* Standard programme for cotton laundry pursuant to the currently effective regulation EU 392/2012

) As tested at the manufacturer's laboratory; comparison between **NATUREDRY** drying program and normal drying program with a heat pump.

If your laundry is not dried to the desired dryness level, use extra functions or use a more suitable programme.

DrySync function

The **DrySync** function allows communication between the washing machine and the dryer. When the washing machine completes the washing cycle, the suggested drying program appears automatically on the dryer, based on the washing program that was used. This function can only be activated or deactivated in the **ConnectLife** mobile app. Animation on the knob will indicate that the function is activated, and  will appear simultaneously on the appliance. The **DrySync** function can only operate between two connectible appliances of the same brand.

Remote control of your dryer using the app

INFORMATION!

See chapter DRYING PROCESS, STEP BY STEP (1–6) and observe steps 1 and 2.

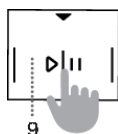

On the appliance:

1. Close the dryer door.
2. Rotate the program selector knob to position **ConnectLife/REMOTE CONTROL** (Remote control)
3. Press the position (9) START/PAUSE. Remote control indicator **REMOTE START**  will be activated.

The appliance switches to standby mode. The appliance can then be remotely controlled for the next 24 hours or until the appliance door is opened. Opening the appliance door will disable **REMOTE CONTROL** (ConnectLife).

Continue operating the appliance in the **ConnectLife** app, where you can choose from several options (selection, launch, and monitoring and stopping of the programme, amongst other additional settings)

INFORMATION!

The drying process can be controlled/monitored from the app.

INFORMATION!

Dryer operation can be interrupted or stopped via the application by selecting STOP/PAUSE or by opening the dryer door.

INFORMATION!

You can also control your appliance from your phone if you are not connected to the same Wi-Fi network as your appliance (the phone only needs an active internet connection). This means you can also control your appliance when you are away from home.

INFORMATION!

You can operate the appliance with multiple devices. You can control and monitor the operation of the appliance with any phone connected to the appliance, regardless of which user has initiated the drying process. The appliance can be connected to/controlled simultaneously with several **ConnectLife**  user accounts.

INFORMATION!

After you have started the appliance from your phone, a person located next to the appliance can take over and manually turn off or control the appliance; the app will notify you in such case. In such case, controlling the appliance remotely from your phone is no longer possible. If you wish to control the appliance from your phone again, all required steps must be repeated.

Step 4: Selecting extra functions



INFORMATION!

Activate/deactivate the functions by pressing the selected function (before pressing the (9) START/PAUSE button ▷||).

Adjust the settings by pressing the relevant function button (just before pressing the (9) START/PAUSE button ▷||).

Functions that can be changed or adjusted with the selected drying programme are partly lit (dimmed).

Certain settings cannot be selected with some programmes. Such settings will not be lit, and the button will flash when pressed (see FUNCTION TABLE).

Description of function indicators for the selected drying programme:

- **Lit** (Basic/preset setting);
- **Dimmed** (Functions that can be adjusted) and
- **Unlit** (Functions that cannot be selected).

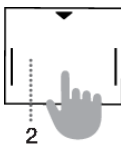
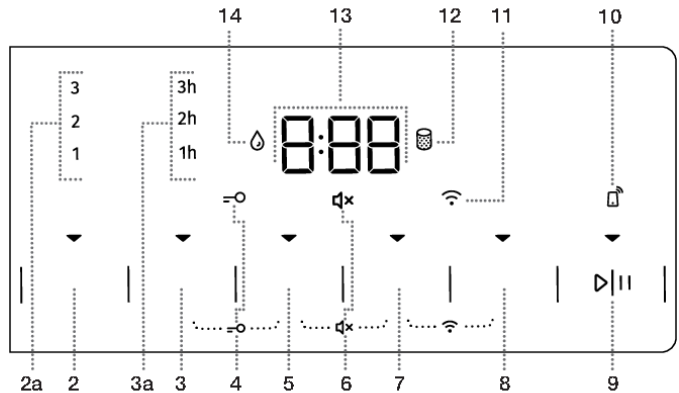

EXTRA DRY (DRYNESS LEVEL)

Press the (2) **EXTRA DRY (DRYNESS LEVEL)** position to adjust (increase) the dryness level and drying duration. This setting can be adjusted before the start of the drying process. After the drying programme is completed, this function is not stored unless the same program with the same settings has been used 3 times in a row (in such case, the **ADAPTTECH** function is activated).

Three higher dryness levels and drying times are available. The extra functions (2a) (1, 2, 3) allow selecting a higher dryness level while extending the drying time. The light on the selected drying mode will be lit up.

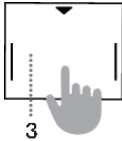

ANTI CREASE (CREASE PREVENTION)

If you do not remove the laundry from the dryer immediately after the completion of the drying programme, we recommend using the (3) **ANTI CREASE (CREASE PREVENTION)** function. This function has to be selected before the start of the drying process.

Press on the position (3) **ANTI CREASE (CREASE PREVENTION)** to choose between 1h, 2h, and 3h duration (3a) or deactivating this function. When you open the dryer door after the completion of the drying programme, the function is automatically deactivated. The function is also deactivated if you press the (9) **START/PAUSE**  key after the completion of the programme.

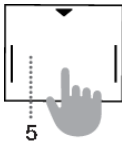

TIME DRY (TIMED DRYING)

By pressing (5) **TIME DRY (TIMED DRYING)**, it is possible to set the drying time on the Time drying programme. The indicator of the selected function will light up. The start time is 0:30, at each press the time increases by 15 min. The maximum drying time is 4:00 h.

To reset (stop) the set drying time, press the position (5) **TIME DRY (TIMED DRYING)** and hold it for three seconds.

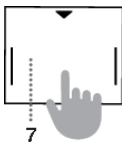

DELAY END (DELAYING THE END OF THE DRYING PROGRAM)

Press on the (7) **DELAY END (DELAYING THE END OF THE DRYING PROGRAM)** to delay the drying end time by up to 24 hours.

If you press any key (except **DELAY END** and **START/PAUSE**) while setting the **DELAY END (DELAYING THE END OF THE DRYING PROGRAMME)** function, then **DELAY END** will be reset. Therefore, before setting the **DELAY END**, all other desired functions have to be set first.

Settings procedure:

- Select the desired programme and extra functions.
- Press on the (7) **DELAY END (DELAYING THE END OF THE DRYING PROGRAM)** to activate the function.
- Repeatedly press this position to set the desired drying completion time (with 30-minute increments up to 6 hours, and 1-hour increments thereafter, up to 24 hours).
- The function is activated when the (9) **START/PAUSE** .

The dryer starts counting down the time. When the countdown reaches the drying programme duration (e.g. 2:30), the drying programme starts automatically.

To stop or change the drying end delay, rotate the drying programme selector knob (1) to position **OFF**  for at least 1 second.

When the dryer is turned on the next time, you can set a new drying completion delay time.

To quickly cancel the programme completion delay, press the position (7) **DELAY END (DELAYING THE END OF THE DRYING PROGRAMME)** and hold it for 3 seconds. The drying programme starts immediately.

Example of function setting:

If you wish the drying programme end at 6:00 in the morning and it is now 21:00, then set the **DELAY END** (DELAYING THE END OF THE DRYING PROGRAM) to 9 hours.

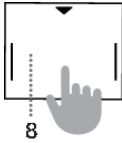

NATURE DRY (LOWER TEMPERATURE)

Press on the (8) **NATURE DRY**  (LOWER TEMPERATURE) position to choose drying at a lower temperature that is friendlier to your laundry.

Drying laundry at a lower temperature than normal in order to reduce the possibility of shrinkage. During the drying process, the temperature is decreased by means of accurate control of heat pump operation and an additional temperature sensor. Therefore, shrinkage of clothes with this program can be up to 50% lower than with normal drying at a normal drying temperature (depending on the garments and type of fabric). The program is intended for garments that may be dried in a dryer.



INFORMATION!

Some functions are not available and cannot be selected with certain programmes; an acoustic signal and a flashing light will indicate such cases (see EXTRA FUNCTION TABLE).

SETTINGS USING A COMBINATION OF TWO BUTTONS PRESSED SIMULTANEOUSLY

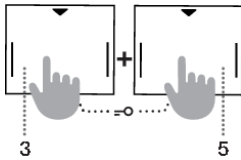
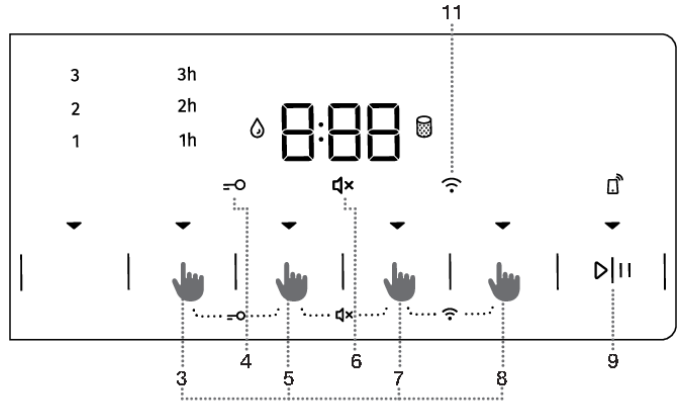

CHILD LOCK

To activate or deactivate the child lock, simultaneously press the positions (3) **ANTI CREASE** (CREASE PREVENTION) and (5) **TIME DRY** (TIMED DRYING) and hold them for at least 3 seconds until the symbol ≡ (4) lights up or goes off, respectively.

If the child lock is activated, programme or additional functions cannot be changed. The child lock remains active after the dryer is switched off. Therefore, it has to be deactivated before a new programme can be selected. It can also be switched on or off during the drying process.

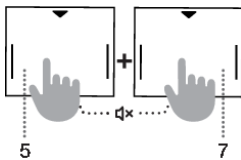

SOUND OFF

To switch off, or mute, the appliance sounds, simultaneously press the positions (5) **TIME DRY** (TIMED DRYING) and (7) **DELAY END** (DELAYING THE END OF THE DRYING PROGRAM) and hold them for at least 3 seconds until the symbol 🔇 (6) lights up or goes off, respectively.

To reactivate the sound, simultaneously press the positions (5) and (7) and hold them for at least 3 seconds. If you turn off the sound, then there is no audible signal at the end of a drying programme.

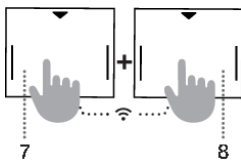



Wi-Fi MENU

The Wi-Fi menu is used for connecting the appliance and for remote control.





Rotate the programme selector knob (1) to any position, except position **OFF** (1).

Simultaneously press the positions (7) **DELAY END** (DELAYING THE END OF THE DRYING PROGRAMME) and (8) **NATURE DRY** (LOWER TEMPERATURE) and hold them for 3 seconds to enter the Wi-Fi settings menu.

You can take one step back by simultaneously pressing the positions (7) and (8) and holding them for 3 seconds.

Use the (8) **NATURE DRY**  (LOWER TEMPERATURE) key to select the available functions; use the (9) **START/PAUSE**  key to confirm your selection.

Available settings:

- **OFF/On**  /  – turning appliance connectivity off or on.
- **Con**  – the appliance is ready for connecting to a Wi-Fi network for 5 minutes.
- **PAr**  – the appliance can be connected to the **ConnectLife** app for 3 minutes. The function will only be active if you have already connected the appliance to your Wi-Fi network.
- **UnP**  – Remove (unpair) all users.



INFORMATION!





















After disconnecting the dryer from the power mains, all settings will be reset to their default factory values, except for the acoustic signal loudness, anti-crease, and child lock setting.



INFORMATION!

The functions **CHILD LOCK** and **SOUNDS OFF** cannot be activated or deactivated 10 seconds after turning on.

Extra function table

Programmes		EXTRA DRY (DRYNESS LEVEL)	ANTI CREASE (CREASE PREVENTION)	TIME DRY (TIMED DRYING)	DELAY END (DELAYING THE END OF THE DRYING PROGRAM)	NATURE DRY  (LOWER TEMPERATURE)
Cotton (Cotton)						
	Storage (Cupboard dry)	•	•		•	
	Standard* □	•	•		•	
	Iron (Moist for ironing)	•	•		•	
	Mix  (Mixed laundry)	•	•		•	•
	Synthetic (Synthetics)	•	•		•	
	Wool (Wool)					
	Bedding (Bedding)	•	•		•	
	Time (Timed program)		•	•		
	Baby  (Baby clothes)	•	•		•	•
	Sensitive  (Delicate)	•	•		•	•
	Shirts  (Shirts)	•	•		•	•
	Sports  (Sportswear)	•	•		•	•
	Fast 89' (Fast 89')		•		•	
	Extra Hygiene	•	•			

- Additional functions can be used

If your laundry is not dried to the desired dryness level, use extra functions or use a more suitable programme.

Step 5: Starting the drying programme

Press the (9) **START/PAUSE** ▷|| key.

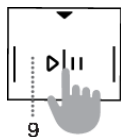

TIME REMAINING TO PROGRAMME COMPLETION or **DELAY END** (DELAYING THE END OF THE DRYING PROGRAM) time (if set) will appear on the display. Symbols will be lit on the selected functions.

If the TIME REMAINING UNTIL PROGRAMME COMPLETION flashes three times on the display unit, and there is an audible signal, this means that the dryer door is open or not closed tightly. Close the dryer door and press the key (9) **START/PAUSE** ▷|| again to resume the drying programme.

Step 6: End of the drying programme

At the end of the drying programme, **End** ("End") will appear on the display unit, the two red indicator lights will light up, the (9) **START/PAUSE** ▷|| button light will flash, and the light for the selected time of **ANTI CREASE** (CREASE PREVENTION) (3a) function, if activated or selected, will flash.



1. Open the dryer door.
2. Clean the filters (see section »CLEANING« ...).
3. Take the laundry from the drum.
4. Close the door!
5. Switch off the dryer (rotate the program selector knob (1) to the **OFF** ⏻ position).
6. Empty the condensate tank.
7. Unplug the power cord from the outlet.



INFORMATION!

After the end of the drying programme, immediately remove the laundry from the dryer to prevent it from creasing again.



WARNING!

The final drying cycle includes a cooling down stage without heater operation. It makes sure the laundry is of suitable temperature at the end of the program and that it can be taken from the dryer without risk of touch hot clothes.

INTERRUPTIONS AND CHANGING THE PROGRAMME

Interruptions

Interrupting the programme process

Press the (9) START/PAUSE ▷|▢ button to pause/resume a programme.

To stop and cancel the drying programme, press the (9) START/PAUSE ▷|▢ button and hold it for 3 seconds. The selected programme will stop, and the dryer will start to cool down. Cooling down time depends on the selected programme. After this process, the drying programme can be selected again.

Open door

If the dryer door is opened during the drying process, the drying cycle will be interrupted.

When the door is closed and the (9) START/PAUSE ▷|▢ button is pressed, the drying will resume from the point at which it was interrupted.



HOT SURFACE!

The dryer door will heat up during the drying process. Make sure you do not burn yourself when opening the dryer door.

Full condensate tank

When the condensate tank is full, the drying cycle will pause (this symbol lights up ☹).

Empty the condensate tank (see chapter »CLEANING AND MAINTENANCE/Emptying the condensate tank«).

Press the (9) START/PAUSE ▷|▢ button to resume the drying programme from the point at which it was interrupted.

Power supply failure

When power supply is resumed, **PF** will appear on the display unit; the signal light on the (9) START/PAUSE ▷|▢ button will flash.

To resume the drying process, press the (9) START/PAUSE ▷|▢ button.

Changing the program/functions

Turn off the dryer by rotating the program selector knob (1) to position **OFF** ⏻. Turn it back on again by rotating the program selector knob (1) to any program.

Select another program/function and press the (9) START/PAUSE ▷|▢ button again.

Adding laundry after the start of the program

Open the dryer door and press the (9) START/PAUSE ▷|▢ button. Insert the laundry and press the button (9) **START/PAUSE** ▷|▢.

Drying time may be extended.



HOT SURFACE!

When loading the laundry, make sure you do not burn yourself when you open the dryer door.

Saving personal settings

Initial settings may be changed.

When the program and additional functions are selected, you may store such combination by pressing the 3 START/PAUSE ▶|| button and holding it for (9) seconds. A signal light on the (9) START/PAUSE ▶|| button and an acoustic signal will confirm your selection. Indication »**saved**« »(saved)« will be appear briefly on the display unit (13).

Press the (9) START/PAUSE ▶|| button to start the drying process.



The changed combination will appear every time you switch on the dryer.

Follow the same procedure to change a previously saved combination.

AdaptTech

When a drying programme setting is used three times in a row, this setting is stored as default and will always be suggested when you select that drying programme – this is called the **ADAPTTECH** function. If you manually store the settings of a drying programme, the **ADAPTTECH** function on this programme is deactivated.

Personal settings menu

To turn on the dryer, rotate the program selector knob (1) to any position. To open the personal settings menu, simultaneously press on the positions (2) **EXTRA DRY** (DRYNESS LEVEL) and (5) **TIME DRY** (TIMED DRYING), and hold them for 3 seconds. The symbols (3) **ANTI CREASE** (CREASE PREVENTION), (12) **CLEAN THE FILTER** , and (14) **CONDENSATE TANK**  will light up on the display unit.

Number 1 will appear on the display unit, indicating the settings function. Rotate the programme selector knob (1) to in either direction to choose the function to change. Number 1 indicates sound settings and number 2 indicates resetting of Personal programme settings to factory defaults. If the desired settings are not selected in 20 seconds, the programme will automatically return to main menu.

Press on the position (3) **ANTI CREASE** (CREASE PREVENTION) to confirm the desired functions and their relevant settings. Press on the position (2) **EXTRA DRY** (DRYNESS LEVEL) to go back one step.

Acoustic signal volume can be set at four levels (0 means the sound is off; 1 means that the button sound is activated; 2 means low volume, and 3 means high volume). Choose the volume level by rotating the programme selector knob (2) to the left or to the right. The lowest setting means that the acoustic signal is switched off.

CLEANING AND MAINTENANCE



ELECTRIC SHOCK!

Before cleaning, make sure to switch off the dryer and disconnect it from the power mains (unplug the power cord from the outlet).

The dryer is fitted with a **filtering system** consisting of several filters that prevent any impurities from entering the heat exchanger system.

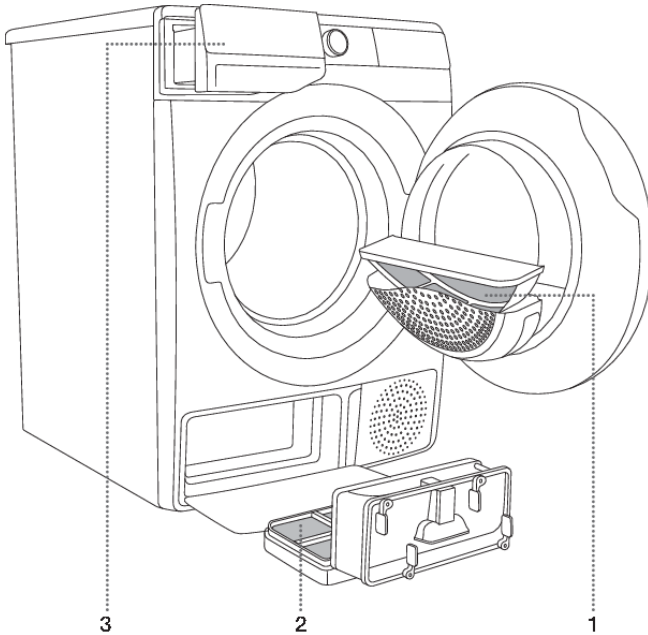

- 1 Net filter
- 2 Heat pump filter
- 3 Condensate tank



INFORMATION!

The dryer may never be operated without the filters in place or with damaged filters, as excessive amount of accumulated fibres from the fabric could cause malfunction or failure of the dryer.

Cleaning the door net filter in the door



INFORMATION!

Clean the net filter after each drying cycle.

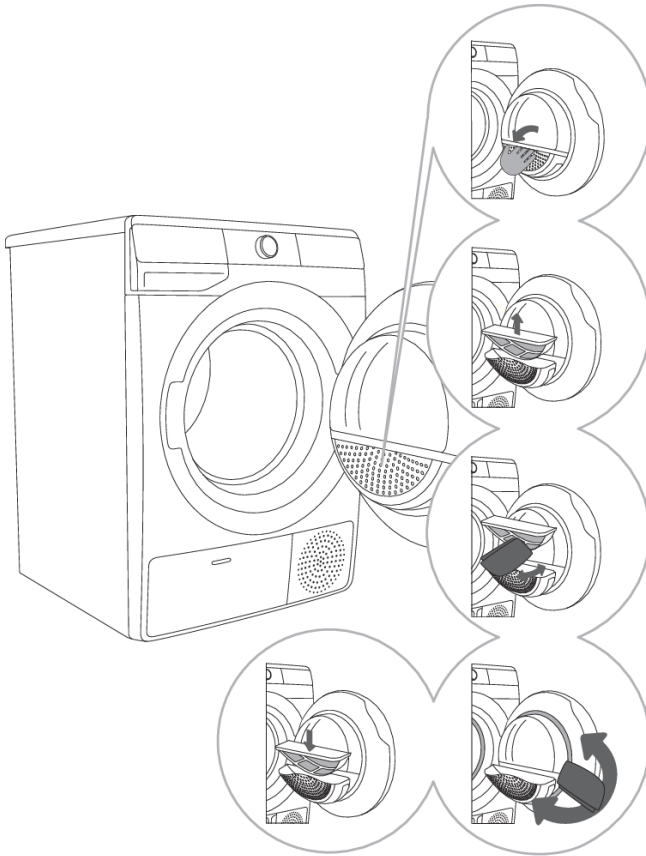

1 Open the filter housing.

2 Pull out the net filter.

3 Gently scrape the filter to remove the lint, i.e. the lining of fibres and threads, with your hand or with a cloth.

4 If necessary, clean the filter housing and door gasket as well.

5 Insert the net filter and close the filter housing.



INFORMATION!

Make sure you do not pinch your fingers with the filter cover.

Cleaning the heat pump filter



INFORMATION!

During cleaning, some water may be spilled. It is therefore recommended to place an absorbent cloth on the floor.

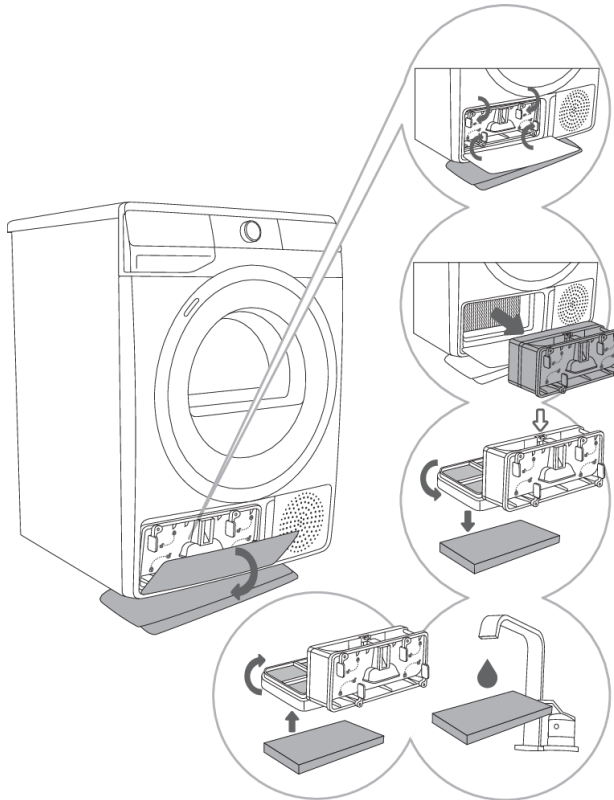

1 Open the outside cover. Hold the levers on the inside cover and rotate them as indicated by the arrows.

2 Remove the inside cover along with the heat pump filter.

3 Detach the front filter part from the heat pump filter housing ↓ and open it. Push the foam part of the filter out from the housing. Use a damp cloth to clean the heat pump filter mesh.

4,5 Wash the sponge filter under running water and dry it, or vacuum the dust and lint from the filter. Replace the clean sponge filter into the filter housing.



INFORMATION!

Insert the heat pump foam filter into the housing and close the outer cover (push it upwards toward the machine until it latches into place).



INFORMATION!

The heat pump filter has to be correctly inserted into its slot. Otherwise, the heat exchanger installed inside the dryer may be clogged or damaged.



INFORMATION!

Clean the foam filter at least after every five drying cycles.

Cleaning of the heat exchanger

WARNING!

Do not touch the inner metal parts of the heat exchanger with bare hands. Danger of injury on sharp parts. Use appropriate protection gloves when cleaning the heat exchanger.

WARNING!

Incorrect cleaning of the metal fins of the heat exchanger can permanently damage the tumble dryer. Do not press on the metal fins with hard objects like for example the plastic tube of a vacuum cleaner.

The dust and dirt in the metal fins of the heat exchanger can be cleaned with a vacuum cleaner and a soft brush attachment.

Access to the heat exchanger is possible, when the heat pump filter is removed as is described in the chapter »Cleaning the heat pump filter«.

Without pressing, gently move the brush attachment only in the direction of the metal fins from top to bottom. Too much pressure can damage or bend the metal fins of the heat exchanger.

INFORMATION!

We recommend you clean the heat exchanger at least every twelve months.

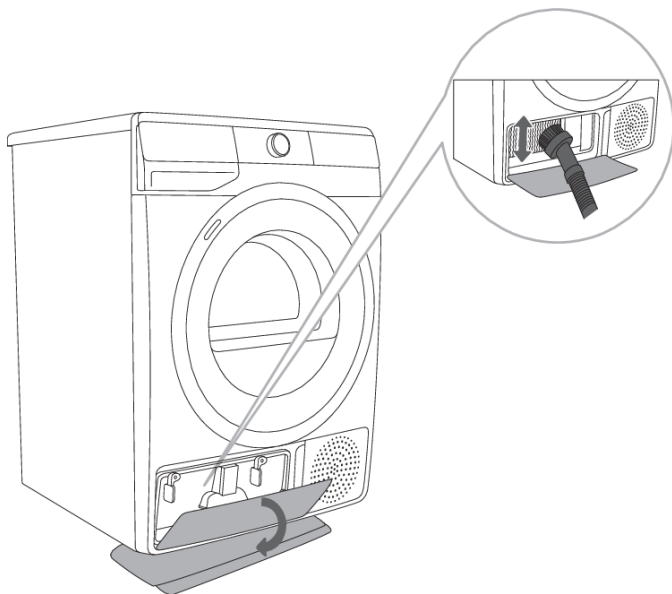

Emptying the condensate tank



INFORMATION!

Empty the condensate tank after each drying cycle.

If the condensate tank is full, the drying programme will be paused automatically.

Symbol  (14) will light up on the display unit, indicating that the condensate tank should be emptied.

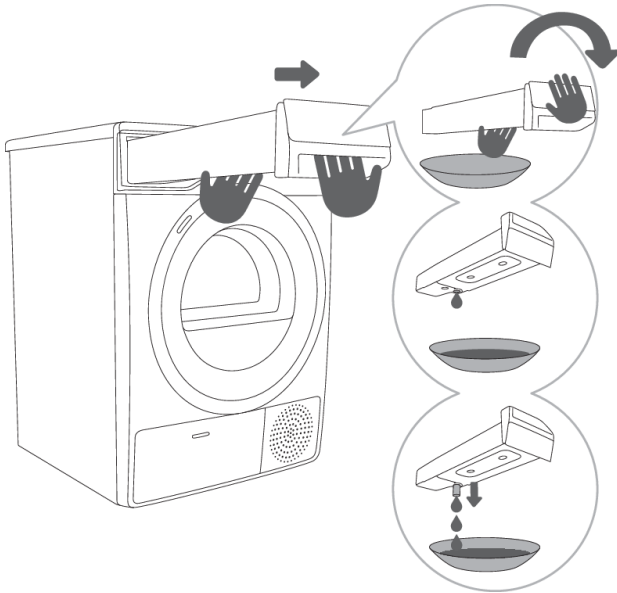

1 Pull out the condensate tank from the dryer (using both hands as shown in the figure), then turn it upside down over a washbasin, sink, or any suitable vessel.

2,3 Empty the condensate tank. Pull out the spout at the opening for easier emptying. Replace the condensate tank.



INFORMATION!

Water from the condensate tank is not drinkable. If thoroughly filtered, it can be used for ironing.



WARNING!

Never add chemicals or fragrances into the condensate tank.

It is not necessary to empty the condensate tank if the drain hose is connected directly to a drain (see chapter »INSTALLATION AND CONNECTION/Draining the condensate«).

Cleaning the dryer



ELECTRIC SHOCK!

Always disconnect the dryer from the power mains before cleaning.

Clean the dryer exterior using a soft damp cotton cloth.



WARNING!

Do not use any solvents or cleaning agents that could damage the dryer (please observe the recommendations and warnings provided by the manufacturers of the cleaning agents).

Wipe all parts of the dryer with a soft cloth until dry.



INFORMATION!

Do not clean the dryer with a jet of water!

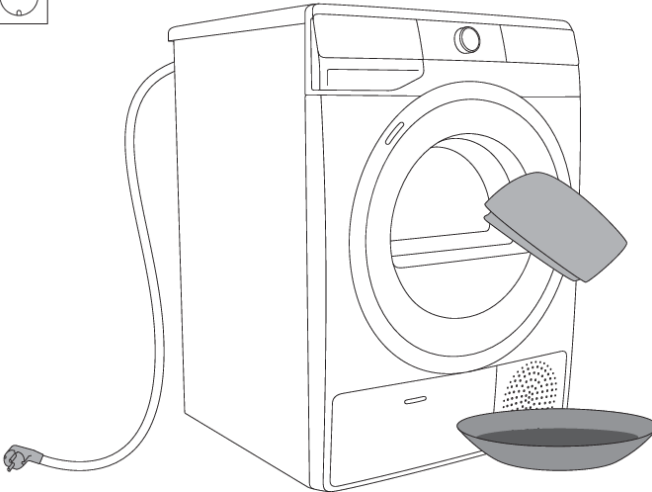

TROUBLE-SHOOTING

What to do ...?

Disturbances from the environment (e.g. the power grid) may result in various error reports (see TROUBLESHOOTING TABLE). In such case:

- Switch off the dryer and wait at least one minute.
- Switch on the dryer and repeat the drying programme.
- Most errors during operation can be resolved by the user (see TROUBLESHOOTING TABLE).
- If the error occurs again, call an authorized service unit.
- Repairs may only be carried out by an adequately trained person.
- Repair or any warranty claim resulting from incorrect connection or use of the dryer shall not be covered by the warranty. In such cases, the costs of repair shall be charged to the user.









Troubleshooting and error table

Problem/Error	Cause	What to do?
The machine will not start.	• The main switch is not switched on.	• Check whether the main switch is on.
	• There is no voltage in the power outlet.	• Check the fuse. • Check if the power cord plug is correctly inserted into the power outlet.
There is voltage in the outlet, but the drum does not spin and the appliance does not work.	• Open door.	• Check if the door is closed properly.
	• The condensate tank is full.	• Empty the condensate tank (see chapter »CLEANING AND MAINTENANCE/Emptying the condensate tank«).
	• Perhaps the DELAY END (DELAYING THE END OF THE DRYING PROGRAM) function was set. • Program was not started in accordance with the instructions.	• To cancel the start delay, press on the position (7) DELAY END (DELAYING THE END OF THE DRYING PROGRAM) and hold for 3 seconds. • Re-read the instructions for use again.
The appliance stops heating completely during a programme.	• The net filter may be clogged. As a result, the temperature in the dryer rises, which in turn causes overheating, and therefore heating is switched off.	• Clean the net filter (see chapter »CLEANING AND MAINTENANCE/Cleaning the net filter in the door«). • Wait for the appliance to cool down, and try running it again. If the dryer still fails to start, call a service technician.





Problem/Error	Cause	What to do?
A slight hitting noise appears.	<ul style="list-style-type: none"> If the dryer is out of use for a long period of time, the support elements are under stress at the same point. 	<ul style="list-style-type: none"> The noise will subside without any intervention.
The door opens during drying.	<ul style="list-style-type: none"> Excessive load on the door (too much laundry in the drum). 	<ul style="list-style-type: none"> Reduce the amount of laundry.
Unevenly dried laundry.	<ul style="list-style-type: none"> Laundry of varying types and thickness, or excessive amount of laundry. 	<ul style="list-style-type: none"> Make sure you have sorted the laundry by type and thickness, whether you have added a suitable amount of laundry to the drum, and whether you have selected a suitable programme (see PROGRAMME TABLE).
Laundry not dried or drying takes too long	<ul style="list-style-type: none"> Filters are not clean. 	<ul style="list-style-type: none"> Clean the filters (see chapter »CLEANING AND MAINTENANCE«).
	<ul style="list-style-type: none"> Dryer is placed in a closed room; room that is too cold; or room that is too small and the air overheats as a result. 	<ul style="list-style-type: none"> Make sure there is adequate supply of fresh air to the dryer; for example, open the door and/or window. Check if the temperature in the room where the dryer is installed is too high or too low.
	<ul style="list-style-type: none"> Laundry was not sufficiently wrung or spun. 	<ul style="list-style-type: none"> If the load is still wet after completed drying cycle, an appropriate drying program should be run again (after cleaning filters).
	<ul style="list-style-type: none"> Amount of laundry dried in the appliance is too large or insufficient. 	<ul style="list-style-type: none"> Use a suitable program or extra functions.
	<ul style="list-style-type: none"> Laundry (such as bedding) gets tangled into large balls. 	<ul style="list-style-type: none"> Close the buttons or zippers on the laundry before drying. Select a suitable programme (e.g. the program Bedding). After the drying process, loosen the laundry and select an additional drying programme (e.g. Time (Timed drying program)).
Drum lighting error (depending on the model)	<ul style="list-style-type: none"> There is no lighting when the dryer door is opened. 	<ul style="list-style-type: none"> Disconnect the dryer from the power mains and call an authorized service unit.

Problem/Error	Cause	What to do?
The appliance cannot be controlled remotely	<ul style="list-style-type: none"> Appliance remote control is not activated or enabled. 	<ul style="list-style-type: none"> Check if the Wi-Fi symbol on the appliance is lit, and set the program selector knob (1) to position REMOTE CONTROL (ConnectLife).
The appliance will not connect to the Wi-Fi network	<ul style="list-style-type: none"> The appliance cannot find your Wi-Fi network. 	<ul style="list-style-type: none"> Check whether 2.4 GHz network is activated on your router and whether the Wi-Fi signal at the appliance is strong enough.

Errors indicated on the display unit may include the following:

Problem/Error	Indication on the display unit and description of error	What to do?
	Control unit failure	Call service centre.
	Temperature sensor failure	Call service centre.
	Communication error	Call service centre.
	Pump error	Call service centre.
	System overheating	Clean the filters. See chapter »CLEANING AND MAINTENANCE/Cleaning the net filter in the door« or call a service technician.
 	Control unit failure	Disconnect the tumble dryer from the power supply. Call service centre.
	The appliance cannot be connected to the Wi-Fi network	The error only affects the option to remotely control your drying programme (remote control). It does not affect the drying process on other programmes. Call a service technician.

Warnings indicated on the display unit may include the following:

Warning	Indication on the display unit and description of warning	What to do?
	Condensate tank warning	Empty the condensate tank before resuming the programme (see chapter »CLEANING AND MAINTENANCE/Emptying the condensate tank«).
	Power supply failure warning	Drying interrupted due to power supply failure. Press the (9) START/PAUSE > < button to restart or resume the drying programme.
	At the end of the drying programme, End (End) will appear on the display unit. Two red symbols  and  will light up. This is not a fault; it is just a warning that the filters need to be cleaned after drying.	Clean the filters and empty the condensate tank.

Write down the error code (e.g. E0, E1), switch off the dryer, and call the nearest authorized service (call centre).

Sounds



INFORMATION!

In the initial drying stage or during drying, the compressor and the heat pump cause noise; this, however, does not affect the tumble dryer operation.

Humming sound: compressor noise; the noise level depends on the program and the drying stage.

Buzzing sound: the compressor is occasionally ventilated.

Pumping or liquid flowing sound: the pump is pumping the condensate into the condensate tank.

Clicking sound: start of automatic cleaning of the heat exchanger (compressor).

Rumbling or rattling noise: during drying when the laundry also includes hard parts (such as buttons, zippers etc.)

Service

Before calling a service technician

When you contact a service centre, please state your dryer's type (1), code/ID (2), model number (3), and serial number (4).

Dryer type, code, model, and serial number can be found on the rating (type) plate on the inner side of the dryer door.

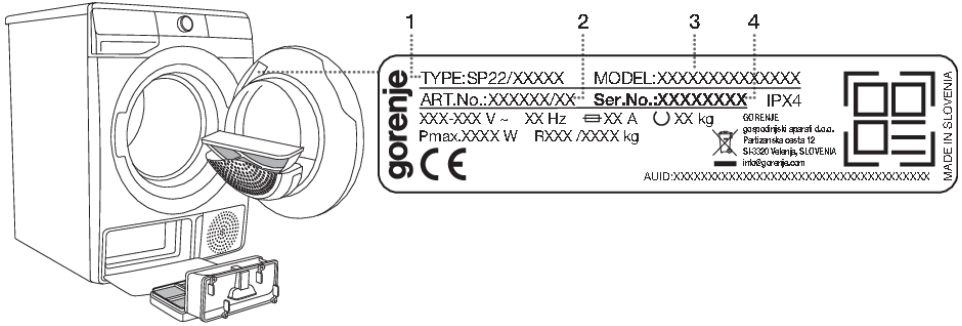

⚠ WARNING!

In case of a failure, only use approved spare parts by authorized manufacturers.

⚠ WARNING!

Repair or any warranty claim resulting from incorrect connection or use of the dryer shall not be covered by the warranty. In such cases, the costs of repair shall be charged to the user.

💡 INFORMATION!

The warranty does not cover the errors or failures resulting from disturbances from the environment (lightning strike, power grid failures, natural disasters etc.).

Additional equipment and accessories for maintenance can be viewed on our website at: www.gorenje.com

TIPS FOR DRYING AND ECONOMIC USE YOUR DRYER

The most economical way of drying is to dry the recommended amount of laundry in each batch (see PROGRAMME TABLE).

Drying laundry made of particularly delicate fabrics that may be deformed is not recommended.

Use of conditioner in the washing cycle is not necessary as the laundry is soft and smooth after drying in the dryer. Drying time will be shorter and power consumption will be lower if the garments are thoroughly wrung or spun before drying. By selecting the appropriate drying programme, you will avoid over-drying your laundry and problems with ironing or shrinkage of fabric.

Regular cleaning of the filters will lead to optimum drying time and minimum power consumption.

When drying smaller amounts of laundry or individual garments, the sensor may not perceive the actual level of moisture in the laundry. In such cases, it is recommended to dry smaller items or amounts with programmes for dryer laundry or with the timed programme.

TYPICAL CONSUMPTION TABLE

The table lists the values for drying time and power consumption for drying of a test batch of laundry with various spinning rpm in the washing machine.

9 kg

Program	Load	Spinning [rpm]	Electric energy consumption [kWh]	Drying time [min]
			9 kg	
Cotton Standard	Total	1000	2,14	215
	Partial	1400	1,32	130
	Low	1000	1,18	124
	Low	1400	1,08	110
Cotton moist for ironing	Total	1000	1,46	150
	Partial	1400	0,88	95
	Low	1400	0,69	70
Synthetics	Partial	1000	0,59	60

Program	Amount of laundry max./half load [kg]	Programme duration [min.]	Electric energy consumption [kWh]
Cotton Standard \square	9/4,5	215/124	2,14/1,18

Standard programmes for cotton laundry in compliance with the currently effective regulation EU 392/2012

The Cotton Standard programme \square , is intended for drying of normally wet cotton laundry. It is the most efficient programme for drying cotton laundry in terms of power consumption.

Due to deviations in terms of type and amount of laundry, power supply oscillation, and environment temperature and humidity, the values measured at the end user may differ from the one stated in the table.

Low standby mode

If you do not run any program or choose any settings after switching on the dryer (programme selector knob (1)), the display unit will be switched off after 5 minutes and switched to stand-by mode in order to save energy.

The display unit can be reactivated by rotating the program selector knob. If you do not do anything for 5 minutes after the end of a programme, the display unit will be switched off to save power.

P_o = weighted power when off [W]	< 0,5
P_I = weighted power when in standby [W]	< 0,5
T_I = standby time [min]	5,00

Appliance with a wireless connection uses less than 2 W of electric energy in standby mode.



INFORMATION!

Low mains voltage and different drying loads may affect the drying time; the remaining time displayed is adjusted accordingly during the drying process.

PRODUCT ENERGY LABEL AND PRODUCT FICHE

(depending on the model)



ENERG

енергия · ενεργεια

Y

IJA

IE

IA

XXXXXX

A+++

A++

A+

A

B

C

D

X

ENERGIA · ЕНЕРГИЯ · ΕΝΕΡΓΕΙΑ
ENERGIJA · ENERGY · ENERGIE
ENERGI

XXX

kWh/annum



XXX

min/cycle*



X

kg



XX

dB



XXXXXXX

*цикъл · cyklus · portion · zyklus
 програма · ciclo · tsükkel
 ohjelma · ciklus · ciklas · cikls
 ciklu · cyclus · cykl · ciclu
 program · torkomgång

392/2012

PRODUCT FICHE according to EU-Regulation No. 392/2012

(depending on model)

Legend

A	Model	XXXXXX
B	Condenser tumble dryer Vented tumble dryer	YES=YES; NO=NO YES=YES; NO=NO
C	Automatic tumble dryer	YES=YES; NO=NO
D	»EU Ecolabel«, Regulation EC 66/2010	YES=YES; NO=NO
E	Energy consumption of the standard cotton programme at full load (E_{dry}) [kWh]	X,XX
F	Energy consumption of the standard cotton programme at partial load ($E_{dry1/2}$) [kWh]	X,XX
G	Power consumption of the off-mode (P_o) [W]	X,XX
H	Power consumption of the left-on mode (P_l) [W]	X,XX
I	The duration of the left-on mode [min]	XX
J	Standard cotton programme, used at full and partial load is the standard drying programme to which the information in the label and the fiche relates. Cotton Standard □ program is intended for drying of normally wet cotton laundry. In terms of total energy consumption, it is the most efficient program for drying cotton laundry.	
K	Weighted programme time (T_t) of the standard cotton programme at full and partial load [min]	XX
L	Programme time of the standard cotton programme at full load (T_{dry}) and partial load ($T_{dry1/2}$) [min]	XX/XX
M	Average condensation efficiency (C_{dry}) / ($C_{dry1/2}$)	XX/XX
N	Weighted condensation efficiency (C_t)	XX
O	Built-in appliance	YES=YES; NO=NO

Based on 160 standard drying cycles with the Cotton Standard (Cotton Standard) □ program at full and half load, pursuant to the currently effective Regulation 392/2012/EU on energy labelling of household tumble driers, measured according to EN 61121.

Actual power consumption will depend on the way the appliance is used.

On a scale from D (the least efficient) to A+++ (the most efficient).

DISPOSAL



Packaging is made of environmentally friendly materials that can be recycled, disposed of, or destroyed without any hazard to the environment. To this end, packaging materials are labelled appropriately.

The symbol on the product or its packaging indicates that the product should not be treated as normal household waste. Take the product to an authorized collection centre for waste electric and electronic equipment processing.

When **disposing** of the appliance at the end of its useful life, remove all power cords, and destroy the door latch and switch to prevent the door from locking or latching (child safety).

Correct **disposal** of the product will help prevent any negative effects on the environment and health of people, which could occur in case of incorrect product removal. For detailed information on removal and processing of the product, please contact the relevant municipal body in charge of waste management, your waste disposal service, or the store where you bought the product.

gorenje

GORENJE gospodinjski aparati, d.o.o. Address: Partizanska 12, 3320 Velenje, Slovenia
Phone: +386 (0)3 899 10 00 Fax: +386 (0)3 899 28 00 www.gorenje.com



903165-a4



We reserve the right to any changes and errors in the instructions for use.