

gorenje

EN

User manual
Dishwasher



GV693E62UVAD

Contents

Your dishwasher	4
Enclosed parts	5
Safety instructions	6
Installation	7
Overflow guard	7
Packaging	7
Disposal	8
Symbols on the appliance	8
Before washing for the first time	9
1. Water hardness	9
2. Basic settings	10
Top up with rinse aid	10
Top up with salt	10
Top up dishwasher detergent for automatic dosing	11
Greener dishwashing	12
Save energy and water	12
Loading the dishwasher	13
Fragile dishes	13
Loading affects the results	13
The dishwasher's baskets	13
Top cutlery tray	13
Upper basket	14
Lower basket	15
Cutlery basket	15
Using the dishwasher	17
Add detergent	17
On/Off	18
Select program	18
Select option	19
Start/Stop	20
Status LedLight	21
If you want to load more dishes	21
Power failure	21
Once the program has finished	21
The best drying results	22
Unloading the dishwasher	22
Program chart	23
ConnectLife	24
Connect to a network and pair	24
Remote control the dishwasher	25
Remote start the dishwasher	25
Pair more devices	25
Deactivate/activate WiFi connection	25
Remove devices	25
Settings	26

Care and cleaning	28
Top up with rinse aid	28
Top up with salt	28
Top up dishwasher detergent for automatic dosing	29
Clean the filter	30
Cleaning the spray arms	30
Clean the outside of the dishwasher	31
CLn - Run the Self-clean program	31
Remove blockages	31
Winter storage/transport	32
Troubleshooting	33
General	33
WiFi	38
Installation	39
Safety instructions	39
Setup	40
Drainage connection	40
Connection to water supply	40
Electrical connection	41
Service	42
Number of program cycles	42
Technical information	43
Technical data	43



Your dishwasher

Install the dishwasher, see the chapter *Installation*. Then open the door and press .

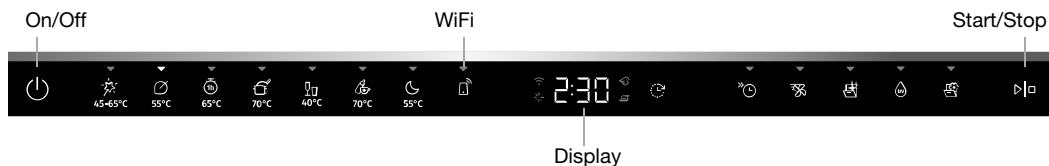



The first time the dishwasher is switched on, it is important that you choose the right settings to ensure good dishwashing results. See the chapter *Before washing for the first time*.



Program

-  Auto 45-65°
-  Eco 55°
-  1h 65°
-  Intensive 70°
-  Glass 40°
-  Hygiene 70°
-  Night 55°
-  WiFi

Option





-  Delayed start
-  Speed wash
-  SmartDry
-  UV Technology
-  Storage

Special program

-  Self-clean

Information on the display

See the chapter *Care and cleaning*.

-  Connected to the cloud (Flashes when connecting)
-  Top up with rinse aid
-  Top up dishwasher detergent for automatic dosing
-  Top up with salt

CLn Run the Self-clean program

NOTE!

The control panel only reacts to use when the door is open.

Enclosed parts

- | | | | |
|----|----------------------|----|---------------------------|
| 1x | Cutlery basket | 4X | Self-adhesive Velcro |
| 1x | Salt funnel | 1x | Protective film |
| 4x | Screw 42x25 | 1x | Lens, status light |
| 6x | Screw T20 4x38 | 1x | User manual |
| 2x | Wood screw 4x15 | 1x | Installation instructions |
| 2x | Distance sleeve 8x12 | 1x | Warranty card |
| 2x | Guide plug | | |

Safety instructions

- Read the user manual and keep it in a safe place!
- Number of standard place settings: 16
- Never use the dishwasher for any purpose other than that specified in these operating instructions.
- Do not load the dishwasher door or dishwasher baskets with anything other than dishes.
- Never leave the dishwasher door open as someone may trip on it. Push the baskets in to avoid risking the dishwasher tipping over.
- Use only dishwasher detergent!
- This machine can be used by children aged 8 and upwards, and by people with reduced physical capacity, mental ability, memory loss or lacking experience and knowledge. These individuals must be supervised when using the machine or have instructions on how to use the machine and understand the risks that can occur. Cleaning of the machine must not be carried out by children without supervision.
- Damaged supply cord must only be replaced by the manufacturer's service centre or someone similarly professionally qualified.
- Only use the dishwasher in household-type environments for dishwashing household dishes. All other use is prohibited.
- Never place dishes with solvent residues in the dishwasher due to the risk of explosion. Nor may dishes that contain ash, wax or lubricants be washed in the dishwasher.
- Children must be watched. Do not allow children to use or play with the dishwasher. Be especially vigilant when the door is open. Some detergent may remain inside! After adding detergent, always start the dishwasher immediately.
- The dishwasher is equipped with a UVC light source. A damaged or defective UVC light source may only be replaced by the manufacturer's service centre or someone similarly professionally qualified.



WARNING!

Knives and other pointed items must be placed with the points down in the cutlery basket or horizontally in other baskets.



WARNING!

 Hazardous Voltage!



WARNING!

Never leave the dishwasher door open to avoid risking the dishwasher tipping over. Please keep children away from the area where the door is open to prevent injury.



WARNING!

Children must be supervised – dishwasher detergent is corrosive!

Installation

See the chapter *Installation*.

Overflow guard

The overflow guard starts pumping out the water and turns off the water supply if the water level in the dishwasher exceeds the normal level. If the overflow guard is triggered, F54 (Overfilling water) appears on the display. Turn off the water tap and contact your nearest service centre. (To avoid water leakage outside the dishwasher, do not remove the plug from the wall socket until the water tap on the supply line has been turned off!)

Phone: 400 808 8899

Packaging

The outer packaging protects the product during transport. The packaging material is recyclable. Separate the different packaging materials to help reduce raw material use and waste. Your dealer can take the packaging for recycling or direct you to the nearest recycling centre. The packaging is comprised of:

- Corrugated cardboard made from up to 100% recycled material.
- Expanded polystyrene (EPS) with no added chlorine or fluorine.
- Supports made from untreated wood.
- Protective plastic made from polyethylene (PE).

Disposal

The dishwasher is manufactured and labelled for recycling. When the dishwasher has reached the end of its service life and is to be disposed of, it should immediately be made unusable. Pull out the power cable and cut it as short as possible.

Contact your local authority for information about where and how your dishwasher should be correctly recycled.

Symbols on the appliance

 Read the user manual.

Before washing for the first time

1. Water hardness

In order to achieve good dishwashing results, the dishwasher needs soft water (water with low mineral content). Hard water leaves a white coating on dishes and the dishwasher.

Checking water hardness

Water hardness is specified using German degrees of water hardness (°dH), French degrees of water hardness (°fH), English degrees of water hardness (°eH) or millimoles per litre (mmol/l).

A water supply with a water hardness in excess of 5°dH (9°fH / 6°eH / 0.9 mmol/l) must be softened. This is done automatically with the aid of the built-in water softener. In order for the water softener to function properly, its settings must be adjusted to the hardness of the water supply. Once you have adjusted the water softener settings, add detergent and rinse aid in doses suitable for soft water.

Contact the local waterworks to check the water hardness in your area.

Make a note of the water hardness: _____

°dH	°fH	°eH	mmol/l	Recommended setting
0-5	0-9	0-6	0.0-0.9	4:00
6-8	10-14	7-10	1.0-1.4	4:01
9-11	15-20	11-14	1.5-2.0	4:02
12-14	21-25	15-18	2.1-2.5	4:03
15-19	26-34	19-24	2.6-3.4	4:04
20-24	35-43	25-30	3.5-4.3	4:05
25-29	44-52	31-36	4.4-5.2	4:06
30-39	53-70	37-49	5.3-7.0	4:07
40-49	71-88	50-61	7.1-8.8	4:08
50	89	62	8.9	4:09

If the water hardness exceeds 50°dH (89°fH / 62°eH / 8.9 mmol/l), we recommend connecting an external water softener.

Increased consumption during regeneration

The dishwasher's built-in water softener is regularly regenerated to maintain its function. Regeneration extends the dishwashing program and increases energy and water consumption. Just how often the dishwasher's water softener is regenerated depends on the selected setting.

Example: If the Eco 55° program is run with a water hardness of 14°dH (25°fH / 18°eH / 2.5 mmol/l), the water softener is regenerated at regular intervals (after 7 dishwashing cycles), energy consumption increases by 0.015 kWh, and water consumption increases by 2.3 litres, while the program time is extended by 3 minutes. Regeneration takes place during the program's main wash.

WARNING!

Hard water leaves a white coating on dishes and inside the dishwasher. It is therefore important that you select the right setting for the water softener! See Water hardness in the chapter *Settings*.

Never run the dishwasher with an empty salt compartment if the water supply has a water hardness in excess of 5°dH (9°fH / 6°eH / 0.9 mmol/l).

2. Basic settings

The first time the dishwasher is switched on, it is important that you choose the right settings to ensure good dishwashing results. See page 26.

Set up:

- Rinse aid
- Water hardness
- TAB (All-in-one detergent)
- Automatic dosing of detergent

3. ✨ Top up with rinse aid

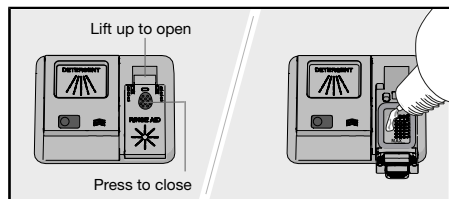

Drying is faster and a better result is achieved if you use rinse aid. You will also achieve a better dishwashing result with clear and spotless dishes.

Top up the rinse aid compartment with rinse aid if you have selected Rinse aid 3:01 - 3:05.

1. Open the rinse aid compartment lid.
2. Carefully top up with rinse aid to the level marked **MAX**.
3. Wipe up any splashes of rinse aid around the compartment.
4. Close the lid firmly.

When the rinse aid needs topping up, the symbol lights on the display.

4. ⚙️ Top up with salt

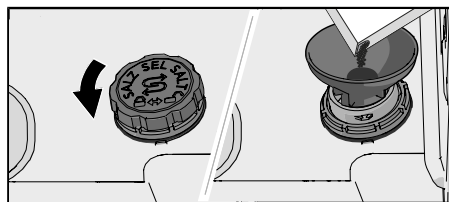

For a water supply with a hardness above 5 °dH (9 °fH / 6 °eH / 0.9 mmol/l), fill with salt.

Add salt to the salt compartment if you have selected Water hardness 4:01 - 4:09.

1. Remove the salt compartment lid by turning it anticlockwise.
2. Place the funnel supplied with the dishwasher in the salt compartment top-up hole. Before washing for the first time, pour in about 1 l of water. (Water is only needed the first time.)
3. Add enough salt to fill the salt compartment (max. 750 gram). Use special dishwasher salt.
4. Wipe away excess salt and turn the lid clockwise until in the closed position.

When the salt needs topping up, the symbol lights on the display.

⚠️ WARNING!

In order to avoid rust stains a dishwashing program must be started immediately after adding salt.

5. Top up dishwasher detergent for automatic dosing

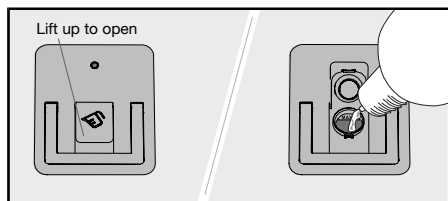

Fill the automatic dosing compartment with dishwasher detergent gel if you have activated the Automatic dosing of detergent setting.

1. Open the lid of the automatic dosing compartment for dishwasher detergent gel.
2. Carefully add dishwasher detergent gel to the level marked **MAX**.
3. Clean up any excess dishwasher detergent gel outside the compartment.
4. Close the lid firmly.



NOTE!

Use only dishwasher detergent gel in the automatic dosing compartment! Do not use dishwasher detergent powder. Washing up liquid must not be used as the foam that forms prevents the dishwasher from operating effectively.

Some thick dishwasher detergent gels are not suitable for the automatic dosing compartment. Add very thick dishwasher detergent gel into the manual detergent compartment. See the detergent manufacturer's recommendations.

Dishwasher detergent gel has a milder formula than dishwasher detergent powder or all-in-one detergent with bleaching agent. This means that dishwasher detergent gel may prove less effective at removing stains caused by, for example, lipstick and tea/coffee. If necessary, on such occasions dishwasher detergent powder or all-in-one detergent with bleaching agent can be added to the manual detergent compartment (when Automatic dosing of detergent is activated). See *Add detergent*.

When the dishwasher detergent gel needs topping up, the symbol appears on the display. (You can run 1-2 wash programs before the compartment is completely empty.)

Dosing of dishwasher detergent gel

Dishwasher detergent gel is dispensed during the main wash for all programs except Self-clean. A little extra dishwasher detergent gel is also dispensed during the prewash in the following programs:

Auto 45-65°

Intensive 70°

Greener dishwashing

Save energy and water

When using a dishwasher in a residential setting, less energy and water are generally used compared to washing the dishes by hand.

Do not rinse under running water



Do not rinse the dishes under running water as this will lead to increased energy and water consumption. Simply scrape off large food particles before loading the dishwasher.

Choose a green detergent

Read the environmental declaration on the packaging!

Too much detergent, rinse aid and salt can result in less effective dishwashing and also entail greater environmental impact.

Run a fully loaded dishwasher

Save energy and water by waiting until the dishwasher is full before running a program. Use the  1h 65° program with the  Speed wash option to rinse the dishes if there are any unpleasant odours.

Run programs at a lower temperature

If the dishes are only slightly dirty, you can select a program with a low temperature.

Select dishwashing program – Eco 55°

This program is suitable for washing normally dirty dishes and is the most effective program in terms of combined energy and water consumption.

The dishwashing program is designed for an effective wash using as little energy and water as possible. The program washes at a low temperature for a long time.

Select option – SmartDry

A shorter dishwashing program and better drying results are achieved if you use the  SmartDry option, which automatically opens the dishwasher door. Wait until the dishwasher indicates that the program has ended and the dishes have cooled before unloading the dishwasher.

Connect to cold water

Connect the dishwasher to the cold water supply if the building is heated using oil, electricity or gas.

Connect to hot water

Connect the dishwasher to the hot water supply (max. 70 °C) if the building is heated using an energy-efficient means such as district heating, solar power or geothermal power. Choosing a hot water connection reduces the dishwasher's energy consumption.

NOTE!

Do not exceed the permitted water supply temperature. Certain materials used in some cookware cannot withstand high heat. See *Fragile dishes* in the chapter *Loading the dishwasher*.

Loading the dishwasher

Fragile dishes

Some cookware is not dishwasher safe. This can be for several reasons. Some materials cannot withstand high heat, others can be damaged by dishwasher detergent.

Exercise caution with, for example, handmade items, fragile decoration, crystal/glassware, silver, copper, tin, aluminium, wood and plastic. Look for the "Dishwasher safe" marking.

Loading affects the results

Load the dishes carefully to ensure the best washing and drying results with the lowest possible energy and water consumption. Give your dishwasher the best chance to reach and clean all surfaces, as well as to dry the dishes as thoroughly as possible.

- All dirty surfaces should face inwards and downwards!
- Dishes should not be placed in or on each other.
- Angle dishes with hollows, such as cups, so that the rinse water will run off. This is also important for plastic items.
- Make sure small items cannot fall through the dishwasher basket; place them in the top cutlery tray.

The dishwasher's baskets

The dishwasher is equipped with a top cutlery tray, an upper basket and a lower basket.

The appearance of the baskets may differ depending on the dishwasher setup.

Top cutlery tray

The top cutlery tray has space for cutlery, ladles, whisks, serving cutlery and similar items.

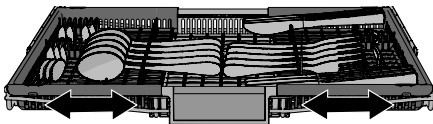
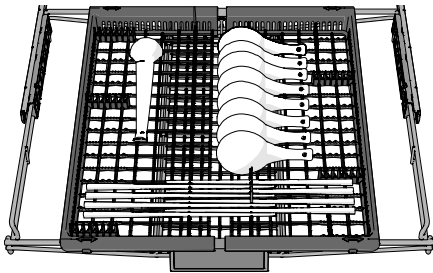

The top cutlery tray is comprised of three parts that can be moved sideways to better accommodate the dishes.

Upper basket

Place glasses, cups, bowls, side plates and saucers in the upper basket. All dirty surfaces should face inwards and downwards! Wine glasses are placed on the wine glass shelf and knives are placed in the knife stand on the right.

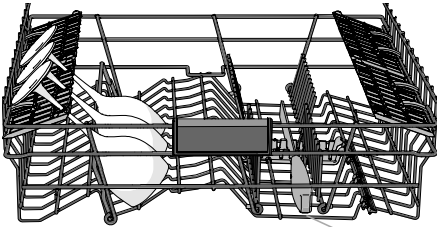
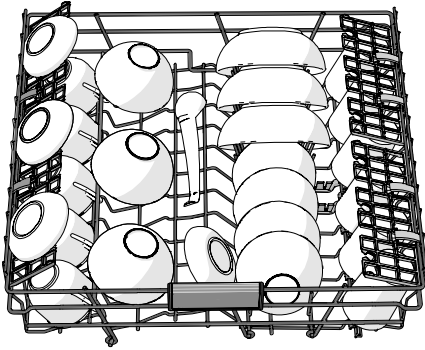

Knife stand

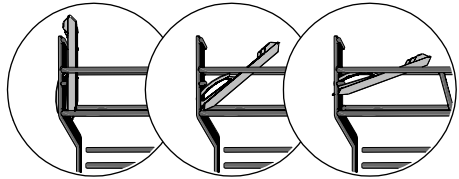

3 positions

Raising and lowering the upper basket

1. Pull out the upper basket.
2. Grab the sides of the upper basket with both hands and lift it up.
3. If the upper basket is raised while in the top position, it will drop to the bottom position.
Note that both sides of the basket must always be set to the same height.

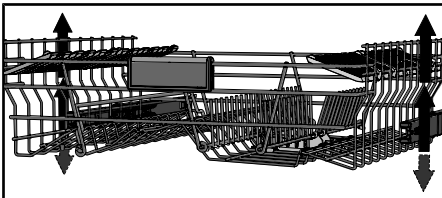

Adjustable plate supports

The adjustable plate supports can be folded down to make it easier to load pots, bowls and glasses.

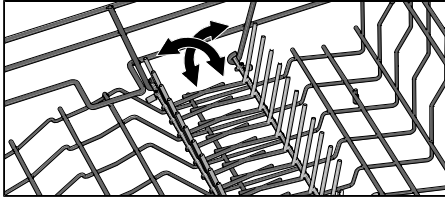

Lower basket

Place plates, side plates, serving dishes, pots and cutlery (in the cutlery basket) in the lower basket.

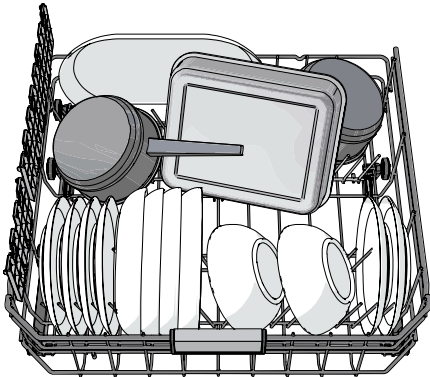

Adjustable plate supports

The adjustable plate supports can be folded down to make it easier to load pots and bowls.

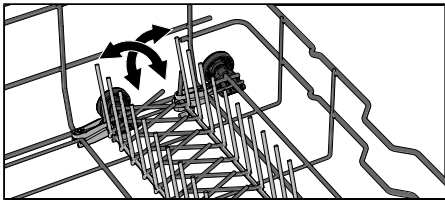

Cutlery basket

Place chopsticks and other cutlery (except for sharp knives) with their handles pointing downwards, and spread them out as much as possible. Check that spoons do not stack inside each other. Ensure that the spray arms can rotate freely.

Place the cutlery basket in the lower basket.

Cutlery basket with lid

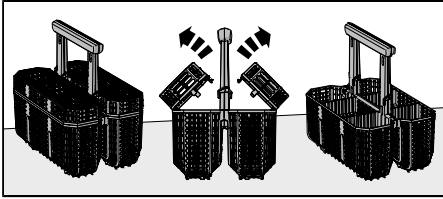

The cutlery basket lid can be removed.

Flexible cutlery basket

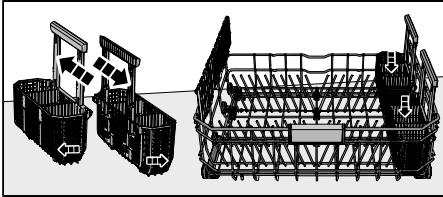

The cutlery basket is flexible and can be separated into two parts, which can then be attached to the side of the lower basket.



NOTE!

Check that the spray arms can rotate freely.

Using the dishwasher

Add detergent

You have two options for adding detergent – manual or automatic. To activate Automatic dosing of detergent, see the chapter *Settings*. The manual detergent compartment can be used as a supplement even when Automatic dosing of detergent is activated (e.g. for dishwasher detergent with bleaching agent or if the automatic dosing compartment is empty).

Follow the instructions on the detergent packaging. This dishwasher is fitted with a water softener, so use detergent and rinse aid doses suitable for soft water.

Do not add detergent to the manual detergent compartment when using automatic detergent dosing! Too much detergent can result in less effective dishwashing and also entails greater environmental impact.

Manual detergent compartment

The detergent compartment must be dry when adding detergent.

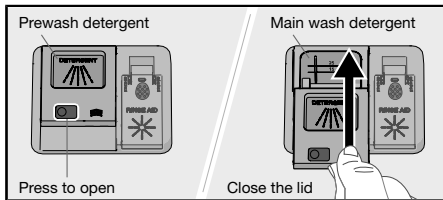

If powder or liquid dishwasher detergent is used, add a small amount of the detergent to the compartment for prewash detergent.

NOTE!

Use only dishwasher detergent! Washing up liquid must not be used as the foam that forms prevents the dishwasher from operating effectively.

All-in-one detergent

There are many types of all-in-one detergents on the market. Read through the directions for these products carefully.

Activate the TAB setting when using an all-in-one detergent that contains rinse aid.

Dishwasher tablets are not recommended for short programs (less than 75 minutes). Use powder or liquid dishwasher detergent instead.

NOTE!

Optimal washing and drying results are achieved by using normal detergent together with separately dispensed rinse aid and salt.

Contact the detergent manufacturer if you have questions about the detergent.

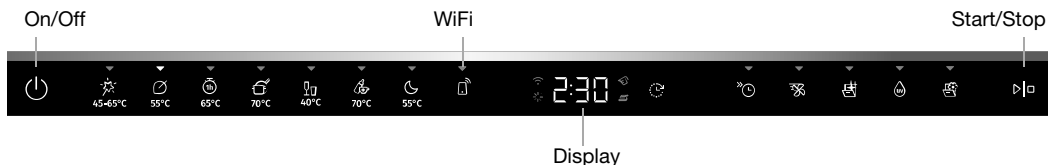

NOTE!

The control panel only reacts to use when the door is open.



On/Off

Open the door and press . Also turn on the water tap if it is turned off.

Select program

Select a program to suit the type of dishes and how dirty they are.

Press the desired program until it is activated, which is indicated by an indicator light.



Auto 45-65°

The dishwasher can measure how dirty the dishes are and adjust water consumption and temperature accordingly. When newly installed, the program needs to be run five times before it is fully adapted and can provide the best results.

If Automatic dosing of detergent is activated, the dosage of dishwasher detergent gel is also adjusted.



Eco 55°

This program is suitable for washing normally dirty dishes and is the most effective program in terms of combined energy and water consumption.

You can read more about greener dishwashing in the chapter *Greener dishwashing*.

For heavily soiled dishes with a lot of grease, a program with higher temperatures should be used.



1h 65°

A quick program for slightly dried leftovers. (This program is not intended for burnt food, such as on oven dishes.)

The SmartDry option is important for ensuring the best drying results.



Intensive 70°

A program with a high temperature for dissolving grease on very dirty dishes, such as pans, casserole dishes and oven dishes. If these dishes do not completely fill the dishwasher, you can add plates and other dishes.



Glass 40°

A gentle dishwashing program with a low temperature for washing fragile items made of crystal/glass. Remember to use a small amount of detergent and to place items so that they do not touch each other during the wash. See also *Fragile dishes* in the chapter *Loading the dishwasher*. Porcelain that has just been used without dried leftovers can also be washed using this program.



Hygiene 70°

This program is ideal to use where demands on hygiene are extra high, e.g. for baby bottles and cutting boards. The temperature is high both in the main wash and in the final rinse.





Night 55°

A quieter dishwashing program, suitable for running at night. The program time is extended.



WiFi

You can remote control this dishwasher with your smartphone/tablet. Connect the dishwasher to your wireless network to be able to remote control and start the dishwasher using the *ConnectLife* app. See the chapter *ConnectLife*.

To remote start the dishwasher, press  and then . APP will flash on the dishwasher's display. Close the door. The status light will flash slowly, indicating that remote start is activated.

In the *ConnectLife* app, select and start a program.

If the door is not closed within 2 minutes, the machine switches off.



Self-clean

Self-cleaning program for hygienic cleaning of the dishwasher tub, spray arms and spray pipes.

This program should be run (with no dishes in the machine) using normal dishwasher detergent or citric acid – add it to the dishwasher's manual detergent compartment. (Detergent is not automatically dispensed with the function Automatic dosing of detergent.) Special dishwasher cleaners are also available on the market. For the removal of limescale deposits, see *Dishwasher tub* in the chapter *Care and cleaning*.



NOTE!

CLn The dishwasher will indicate at regular intervals that Self-clean needs to be run.



Select option

Press the options to activate them. (The available options vary between programs.)



Delayed start

When you select Delayed start, the dishwasher will start 1-24 hours after you have pressed  and closed the door.

1. Press  once to activate Delayed start. Press several times, or hold it in, to set the desired number of hours. The time for Delayed start is shown on the display.
2. Press . Close the door. The timer counts down and the dishwasher starts after the selected delay.

If you want to cancel the Delayed start option, open the door then press and hold  for three seconds.

Not available for: Self-clean



Speed wash

This option shortens the program time, but uses more energy and water.

Press  to activate the option. The program time is updated on the display.

Not available for: Auto 45-65°, Glass 40°, Hygiene 70°, Night 55°, Self-clean

SmartDry

The dishwasher's fan, together with the automatic door opening function, shortens the program time and improves the drying results. Wait until the dishwasher indicates that the program has ended and the dishes have cooled before unloading the dishwasher.

The drying time of the SmartDry option varies (from 5 to 90 minutes) depending on the model, program and temperature of the final rinse.

Press  to activate the option, which is indicated by an indicator light.

The SmartDry option is pre-selected for some programs.

Not available for: Hygiene 70°, Self-clean

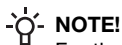

NOTE!

For the best drying results, do not close the door before the drying phase has finished and the machine has automatically switched off.



WARNING!

The dishwasher door must not be blocked or closed when opened automatically. Doing so may damage the door lock mechanism. Wait at least 5 minutes before closing the door.



UV Technology¹⁾

The water in the final rinse is sanitised with UV light and heat to kill microorganisms. The dishwasher uses more energy and the program time is extended.

Press  to activate the option, which is indicated by an indicator light.

Not available for: Quick 35°



Storage¹⁾

The water in the final rinse is sanitised with UV light and heat to kill microorganisms. This antibacterial environment inside the dishwasher is maintained until the dishwasher door is opened. The fan is activated at intervals for 96 hours. Storage automatically ends if the door is opened.

The dishwasher uses more energy and water and the program time is extended.

Press  to activate the option, which is indicated by an indicator light.

Not available for: 1h 65°, Night 55°, Self-clean

▷|□ Start/Stop

Press ▷|□. The display will start to flash, indicating that the dishwasher is ready to start. Close the door properly, otherwise the dishwasher will not start.

To remote start the dishwasher, see the chapter *ConnectLife*.

¹⁾ In accordance with the QB/T5133-2017 standard.

Stopping or changing a program

Open the door. If you want to interrupt or change the program after starting the dishwasher, press and hold **▶▶** for three seconds.

Top up with new detergent if the lid of the detergent dispenser has opened. Then select a new program, press **▶▶** and close the door.

Remaining time

Once you have chosen a program and options, the time the program took when last used is displayed.

Status LedLight

The status light on the bottom part of the dishwasher indicates that a program has started.

Flashing light

A flashing light indicates that the door has been opened while a program is in progress. If it flashes when the door is closed, an error has occurred. See the chapter *Troubleshooting*.

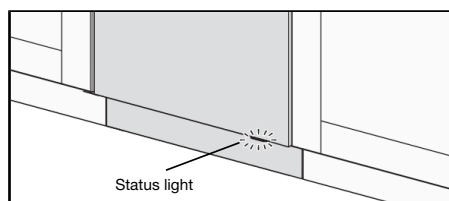

If you want to load more dishes²⁾

Open the door. The dishwasher stops automatically. Add the dishes and close the door. After a while, the dishwasher continues the program.

If the dishwashing program was remote started, the interrupted program will continue once the door is closed. You can monitor the dishwasher using the *ConnectLife* app and remote stop the program, although you will not be able to remote start it again.

Power failure

If the dishwasher is turned off due to a power failure when a dishwashing program is running, the program continues when power is restored. If the power is cut during drying, the program is interrupted.

Once the program has finished

The end of the program is indicated by one short signal from the buzzer. The chapter *Settings* describes how to change this function.

Moreover, the end of the program is indicated by the status light turning off.

Once the dishwasher door is opened and the program has finished "End" appears on the display.

The dishwasher switches off automatically after the program ends. Shut off the water tap after each use (if required by your insurance company).

²⁾ You can load more dishes within 5 minutes after you have started the dishwasher.

The best drying results











- Fully load the dishwasher.
- Angle dishes with hollows, such as cups, so that the rinse water will run off. This is also important for plastic items.
- Top up with rinse aid or increase the rinse aid dosage setting.
- Activate the ☞ SmartDry option.
- Allow the dishes to cool before unloading the dishwasher.

Unloading the dishwasher

Hot porcelain is more fragile. Leave the dishes to cool in the dishwasher before unloading them.

Unload the lower basket first to avoid any water drops from the upper basket falling onto the dishes in the lower basket.

Program chart

Program	Detergent (ml)	Option	Number of prewashes	Main wash	Number of rinses	Final rinse	Consumption values ¹⁾		
							Dishwashing time (approx. hrs:min)	Energy (approx. kWh)	Water cons. (liter)
 Auto 45-65°	25	 3)	1-2	45-65 °C	2-3	60 °C	2:10-3:10	0.9-1.4	11.5-19.0
 Eco 55° 2)	25	 3)		55 °C	2	48 °C	3:45	0.800	9.6
 1h 65°	25	 3)		65 °C	3	65 °C	1:00	1.1	15.0
 Intensive 70°	25		2	70 °C	2	70 °C	2:50	1.6	16.0
 Glass 40°	20			40 °C	2	50 °C	1:40	0.7	10.0
 Hygiene 70°	25			70 °C	2	70 °C	1:05	1.3	11.0
 Night 55°	25		1	55 °C	2	65 °C	5:35	1.4	14.0

1) Consumption values vary depending on the temperature of the incoming water, room temperature, load size, selected additional functions and more.

The dishwasher's built-in water softener is regularly regenerated to maintain its function. Regeneration extends the dishwashing program and increases energy and water consumption. Just how often the dishwasher's water softener is regenerated depends on the selected setting.



2) This dishwashing program is the standard cleaning cycle used for testing according to GB 38383-2019.

3) SmartDry

Remote control the dishwasher

The dishwasher's network symbol  is shown on the display when the dishwasher is paired with a smartphone/tablet. You can use the *ConnectLife* app to monitor the dishwasher and change settings.

Remote start the dishwasher

To remote start the dishwasher, press . APP will appear on the display indicating that remote start is activated. Close the door. (To deactivate the function, press  again. OFF will appear on the display.)



In the *ConnectLife* app, select and start a program.

NOTE!

The dishwasher can always be used without the app. When the dishwasher's control panel is pressed, commands from the *ConnectLife* app are blocked for 10 seconds.



Pair more devices

Pair more devices/users with the dishwasher.

- In the *ConnectLife* application, go to the »Add devices« menu and select the appropriate type of device. Then scan the QR code (it can be found on the serial number plate of the appliance; you can also enter the AUID/SN number manually).
- Open the dishwasher door and press .
- On the dishwasher's control panel: Press and hold  for 4 seconds to start connecting. P appears on the display, after which the display starts counting down.



Deactivate/activate WiFi connection

After connecting the dishwasher to your local network, you can deactivate the WiFi connection. You can then reactivate the WiFi connection to reconnect to the same network.

- On the dishwasher's control panel: Press and hold  for 8 seconds to deactivate the WiFi connection. Off appears on the display.
- On the dishwasher's control panel: Briefly press  to reactivate the WiFi connection. On appears on the display.







Remove devices

Remove all connected devices/users.

- On the dishwasher's control panel: Press and hold  until P is shown on the display. Once a countdown has begun, press and hold  for 3 seconds. UnP indicates that all devices/users have been erased.

Do you have questions? Please visit us at www.connectlife.io or contact us at hello@connectlife.io.

Settings

1. Open the door and press .
2. To open the dishwasher's settings menu, press and hold  and  until SET is shown on the display.
3. Press  to step through the settings menu.
4. Press  to step through the alternatives.
5. Confirm the selected setting by pressing .
6. To exit the menu, step through it or press .



Settings	Alternatives	
Sounds	2:00 - 2:03 (2:00 Off)	A beep confirms that the control panel has been pressed. A beep indicates when a dishwashing program has ended. <i>Error messages are always indicated by a loud buzzer.</i>
Rinse aid	3:00 - 3:05 (3:00 Off)	Setting for rinse aid dosage. The rinse aid dispenser can be adjusted between 3:00 (Off) and 3:05 (High dosage). Increase the rinse aid dosage: <ul style="list-style-type: none"> • If the dishes have water marks. Decrease the rinse aid dosage: <ul style="list-style-type: none"> • If the dishes have a sticky white/blue film. • If the dishes are streaked. • Build-up of foam. If you have very soft water, the rinse aid can be diluted 50:50 with water. <i>Pre-selected at factory: 3:04</i>
Water hardness	4:00 - 4:09 (4:00 Off)	Adjusting the water softener. Select a setting depending on the hardness of the water supply. It is important that this setting is correct! See <i>1Water hardness</i> in the chapter <i>Before washing for the first time</i> . For a water supply with a hardness above 5 °dH (9 °fH / 6 °eH / 0.9 mmol/l), fill with salt. For a water supply with a hardness below 6°dH (10°fH / 7°eH / 1.0 mmol/l), select 4:00. The water softener is deactivated and no salt needs to be added. <i>Pre-selected at factory: 4:04</i>

Settings	Alternatives	
TAB (All-in-one detergent)	5:00 (Off) 5:01 (On)	Activate the setting when using all-in-one detergent containing rinse aid. (Also applies to dishwasher detergent gel for automatic dosing that contains rinse aid.) This setting reduces the rinse aid dosage and affects how often the dishwasher's built-in softener is regenerated. <i>Pre-selected at factory: 5:00</i>
Automatic dosing of detergent 00-40 ml	6:00 - 6:40 (6:00 Off)	Activate this setting if you want to use automatic dosing of detergent. <i>The exact dosage depends on which program is running. For the Auto 45-65° program, the dosage also depends on how dirty the dishes are.</i> <i>Pre-selected at factory: 6:00</i>
Interior light when the dishwasher is switched off	8:00 (Off) 8:01 (On)	Select whether the interior light is to be switched on when the dishwasher is turned off and the door is opened. (If the dishwasher is turned on, the interior light is always switched on when the door is opened.)
Error readout	F--	Any error messages. <i>When contacting the service department, you may be asked to provide the most recent error messages.</i>
Restore factory defaults	rSt	Restores all settings to the factory defaults. Select rSt and confirm by pressing > ◻.
Exit	End	To exit the dishwasher's settings menu, select End and press ⏏ . (The menu closes automatically after three seconds.)

Care and cleaning

✨ Top up with rinse aid

When the rinse aid needs topping up, the above symbol lights on the display.

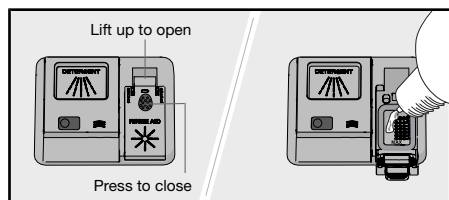

1. Open the rinse aid compartment lid.
2. Carefully top up with rinse aid to the level marked **MAX**.
3. Wipe up any splashes of rinse aid around the compartment.
4. Close the lid firmly.

After topping up, it may take a while before the symbol goes out.

⊞ Top up with salt

When the salt needs topping up, the above symbol lights on the display.

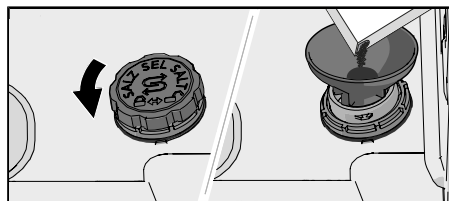

1. Remove the salt compartment lid by turning it anticlockwise.
2. Place the funnel supplied with the dishwasher in the salt compartment top-up hole. (Water is only needed the first time.)
3. Add enough salt to fill the salt compartment (max. 750 gram). Use special dishwasher salt.
4. Wipe up any excess salt so that the lid can be screwed on firmly.

After topping up, it may take a while before the symbol goes out.

⚠ **WARNING!**

In order to avoid rust stains a dishwashing program must be started immediately after adding salt.

Never pour dishwasher detergent into the salt compartment. This destroys the water softener!

Top up dishwasher detergent for automatic dosing

When the dishwasher detergent gel has run out and needs to be refilled, the above symbol appears on the display. (You can run 1-2 programs before the compartment is completely empty.)

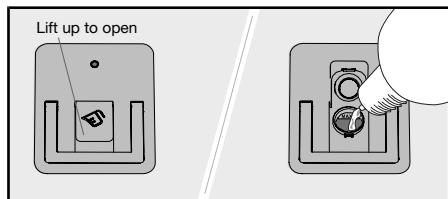

1. Open the lid of the automatic dosing compartment for dishwasher detergent gel.
2. Carefully add dishwasher detergent gel to the level marked **MAX**.
3. Clean up any excess dishwasher detergent gel outside the compartment.
4. Close the lid firmly.

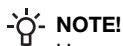

NOTE!

Use only dishwasher detergent gel in the automatic dosing compartment! Do not use dishwasher detergent powder. Washing up liquid must not be used as the foam that forms prevents the dishwasher from operating effectively.

Some thick dishwasher detergent gels are not suitable for the automatic dosing compartment. Add very thick dishwasher detergent gel into the manual detergent compartment. See the detergent manufacturer's recommendations.

Clean the automatic dosing compartment

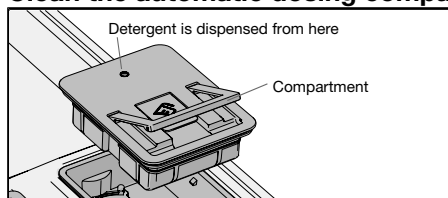

1. The compartment can be lifted out for cleaning and refilling.
2. Check that the dispensing hole is not blocked. Clean the compartment with hot water.

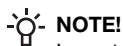

NOTE!

Important - refit the compartment. The dishwasher must not be used without the automatic dosing compartment in place!

Clean the filter

The filter traps larger food particles, which cannot get past the drainage pump. Empty the filter when necessary. It should be cleaned at regular intervals depending on how often the dishwasher is used.

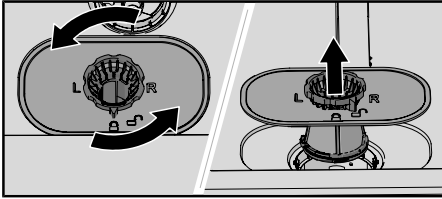

1. Turn the locking ring anticlockwise and lift the filter straight up.
2. Empty and clean the filter.
3. Refit the filter and turn the locking ring clockwise to its stop position. Check that the edges seal properly.



NOTE!

Dishwashing results may be affected if the filter is fitted incorrectly. The dishwasher must not be used without the filter in place!

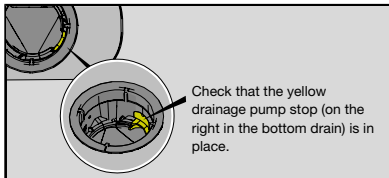

Cleaning the spray arms

Holes and bearings can sometimes become blocked. Remove any debris using a pin or the like. The spray arms also have holes underneath.

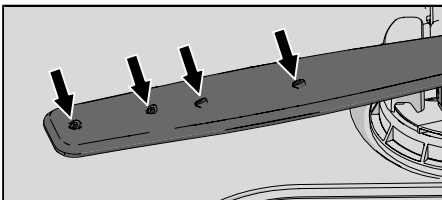

To facilitate cleaning you can remove the spray arms. Remember to fit them firmly back into place afterwards.

Upper spray arm

- Pull out the upper basket.
- Unscrew the spray arm bearings anticlockwise to remove the spray arm from the upper basket.

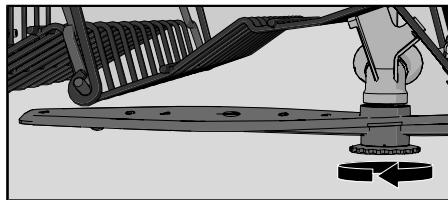

Lower spray arm

- Pull the lower spray arm straight up to release it.

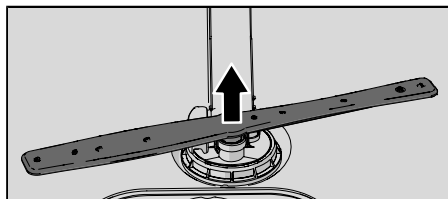

Clean the outside of the dishwasher

Door and door seal

Open the door. Clean the sides of the door and the door seal regularly with a slightly damp cloth. Clean the door seal at the lower front edge of the dishwasher with a washing-up brush.

Control panel

Keep the control panel clean. If necessary, wipe it with a dry or slightly damp cloth. Never use cleaning products – they may scratch the surface.

CLn - Run the Self-clean program

Dishwasher tub

The dishwasher tub is made of stainless steel and is kept clean through normal use (when used regularly).

If you have hard water, limescale deposits may build up in the dishwasher. If this happens, run the Self-clean program with two tablespoons of citric acid in the dishwasher's manual detergent compartment (with no dishes in the machine). Special dishwasher cleaners are also available on the market.

Remove blockages

Unblocking the drainage pump

If the dishwasher still contains water after the program has finished, something may be blocking the drainage pump, which results in the error message Water outlet fault or BLDC drain pump fault.

1. Turn off the machine using  and remove the plug from the wall socket.
2. Remove the coarse filter and the fine filter.
3. Scoop out the water from the dishwasher tub.
4. In order to inspect the drainage pump, remove the yellow drainage pump stop on the right in the bottom drain. (Use a pair of pliers if necessary.)
5. Turn the pump wheel located behind the drainage pump stop by hand. Carefully remove any sharp items, such as glass.

6. Refit the drainage pump stop along with the fine and coarse filters.
7. Plug the machine in again.

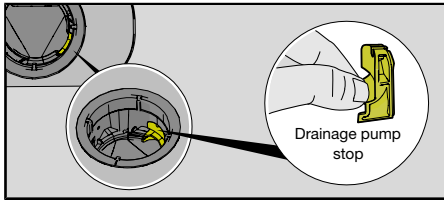

NOTE!
Do not forget to refit the drainage pump stop.

Unblocking the inlet hose filter

If the water supply contains small particles, the outer filter on the inlet hose may become blocked, which results in the Water inlet fault error message.

1. Turn off the machine using ⏻ and remove the plug from the wall socket.
2. Turn off the water tap.
3. Unscrew the inlet hose.
4. Carefully remove the outer filter from the inlet hose and clean it.
5. Refit the filter and check that the gasket is correctly positioned.
6. Screw the inlet hose firmly into place.
7. Plug the machine into the wall socket and turn on the water tap. Allow the pressure to settle for a while and check that the connection is watertight.

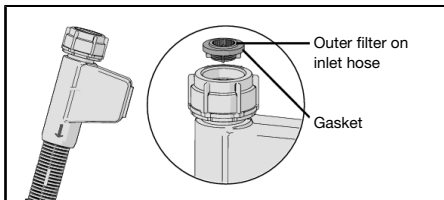

Winter storage/transport

Store the dishwasher above freezing temperature and avoid long transport distances in very cold weather. Transport the dishwasher upright or laying on its back.

Before transporting a used dishwasher, or before prolonged storage, water must first be removed from the machine.





Troubleshooting



Error messages		Action
F10	Overfilling water	Unblocking the drainage pump. See the chapter <i>Care and cleaning</i> . If the problem persists, contact your nearest service centre.
F11	Water outlet fault	See "Water remains in the dishwasher" under "Problem" in the table below. If the problem persists, contact your nearest service centre.
F12	Water inlet fault	Check that the water tap is on. Check that the outer filter on the inlet hose is not blocked. See <i>Unblocking the inlet hose filter</i> in the chapter <i>Care and cleaning</i> . If the problem persists, contact your nearest service centre.
F40	Inlet valve leakage	Turn off the water tap and contact your nearest service centre.
F41	Heater fault 1	Turn off the water tap. Remove the plug from the wall socket and contact your nearest service centre.
F45	Diverter fault	Contact your nearest service centre.
F52	Water level fault	Clean the coarse and fine filters. Check that the outer filter on the inlet hose is not blocked. If the problem persists, contact your nearest service centre.
F54	Overfilling water	Turn off the water tap and contact your nearest service centre. To avoid water leakage outside the dishwasher, do not remove the plug from the wall socket until the water tap on the supply line has been turned off!
F56	Circulation pump fault	Contact your nearest service centre.
F67	Water inlet fault	Check that the water tap is on. Check that the outer filter on the inlet hose is not blocked. See <i>Unblocking the inlet hose filter</i> in the chapter <i>Care and cleaning</i> . If the problem persists, contact your nearest service centre.
F68	BLDC drain pump fault	See "Water remains in the dishwasher" under "Problem" in the table below. If the problem persists, contact your nearest service centre.

Press any button to clear the error message.

General

Problem	Possible causes	Action
The control panel does not react when pressed.	You have pressed the control panel too soon after opening the door.	Wait a moment then try again.
	The door is closed.	Open the door. The control panel only reacts to use when the door is open.
	Dirt on the control panel.	Clean with a dry or slightly damp cloth.

Problem	Possible causes	Action
	The control panel requires calibration.	Turn off the water tap. Remove the plug from the wall socket and wait for 60 seconds. Then plug the appliance back into the wall socket and turn on the water tap.
Cannot close door.	The baskets are not correctly positioned.	Check that the baskets are correctly positioned horizontally. Check that the dishes are not blocking the baskets from sliding properly into place.
	The door lock does not click into place and lock.	Check the door lock. If it does not click into place and lock, open the door. Press and hold  SmartDry until the display starts counting down. Wait until the countdown ends (60 seconds). Close the door. Check that the door lock clicks into place and locks.
The dishwasher does not start.	 has not been pressed.	Press  . The display starts counting down.
	The door is not properly closed.	Check.
	You have opened the dishwasher to add more dishes while a program is in progress.	Close the door and wait. After a while, the dishwasher continues the program.
	The door lock has not clicked into place and locked.	Check the door lock. If it does not click into place and lock, open the door. Press and hold  SmartDry until the display starts counting down. Wait until the countdown ends (60 seconds). Close the door. Check that the door lock clicks into place and locks.
	Check whether the Delayed start option has been selected.	Press and hold  for three seconds if you want to cancel the Delayed start option.
	The plug is not plugged into the wall socket.	Check.
	A fuse/circuit breaker has been tripped.	Check.
The dishes are not clean.	The spray arms do not rotate.	Check that the dishes are not blocking the spray arms.
	Spray arm holes or bearings blocked.	Clean the spray arms. See the chapter <i>Care and cleaning</i> .

Problem	Possible causes	Action
	Unsuitable dishwashing program.	Select a program with a high temperature to dissolve grease on very dirty dishes, such as Intensive 70°.
	Incorrect detergent dosage.	Dose according to water hardness. Far too much or far too little detergent results in poorer dishwashing results.
	Old detergent. Detergent is a perishable product.	Avoid large packages.
	Automatic dosing of detergent is activated, but dishwasher detergent gel is not dispensed.	To check that detergent is dispensed, press and hold  and  for five seconds. The symbol  will flash on the display and the status light will turn on. Now check whether any dishwasher detergent gel has been dispensed.
	Dishes loaded incorrectly.	Do not cover porcelain with large bowls or the like. Avoid placing very tall glasses in the corners of the baskets. See the chapter <i>Loading the dishwasher</i> .
	Glasses and cups have toppled over during the program.	Place dishes to sit steady.
	The filters are clogged.	Clean the coarse and fine filters.
	The filters are not fitted correctly.	Check that the filters are fitted correctly. See the chapter <i>Care and cleaning</i> .
	Drainage pump stop missing.	Check that the yellow drainage pump stop (on the right in the bottom drain) is in place. See the chapter <i>Care and cleaning</i> .
Spots on stainless steel or silver.	Some foodstuffs, such as mustard, mayonnaise, lemon, vinegar, salt and dressings, can cause spots on stainless steel if left for too long.	Rinse off these types of foodstuffs if not starting the dishwasher immediately. Consider using 1h 65° with the Speed wash option.
	All stainless steel can cause spots on silver if they come into contact during dishwashing. Aluminium can also cause spots on dishes.	In order to avoid marks and tarnishing, separate dishes made from different metals, such as silver, stainless steel and aluminium.
Spots or films on the dishes.	Incorrect rinse aid dosage setting.	See the chapter <i>Settings</i> .

Problem	Possible causes	Action
	The setting TAB is activated and all-in-one detergent with insufficient drying effect is being used.	Switch all-in-one detergents or deactivate the TAB setting and top up with salt and separate rinse aid. See Rinse aid in the chapter <i>Settings</i> .
	Salt compartment empty.	Top up with salt. See the chapter <i>Before washing for the first time</i> .
	Incorrect water softener setting.	See Water hardness in the chapter <i>Settings</i> .
	The water softener is leaking salt.	Check that the salt compartment lid is properly tightened. Otherwise contact your nearest service centre.
	Too high temperature and/or too much detergent can cause etching on crystal. Unfortunately, this cannot be repaired, only prevented.	Wash crystal at a low temperature and with a conservative amount of detergent. Contact the detergent manufacturer.
The dishes have a sticky white/blue film.	Rinse aid dosage setting too high.	Reduce the dosage. See the chapter <i>Settings</i> . If you have very soft water, you may want to dilute the rinse aid 50:50 with water.
Spots left after washing.	Lipstick and tea/coffee stains can be difficult to remove.	Use a detergent with a bleaching agent.
		Dishwasher detergent gel is being used. If necessary, on such occasions dishwasher detergent powder or all-in-one detergent with bleaching agent can be added to the manual detergent compartment (when Automatic dosing of detergent is activated). See <i>Add detergent</i> .
Detergent residue in the detergent compartment after dishwashing.	The detergent compartment was damp when adding detergent.	The detergent compartment must be dry when adding detergent.
	The detergent compartment has been blocked.	Check that the dishes are not preventing the detergent compartment from opening.
Rattling sound when dishwashing.	The dishes are not correctly placed or the spray arms are not rotating.	Check that the dishes are placed securely. Spin the spray arms to make sure they can rotate.
Water remains in the dishwasher.	The filters are clogged.	Clean the coarse and fine filters.

Problem	Possible causes	Action
	The filters are not fitted correctly.	Check that the filters are fitted correctly. See the chapter <i>Care and cleaning</i> .
	Debris in the drainage pump.	Clean the drainage pump. See the chapter <i>Care and cleaning</i> .
	Drainage pump stop missing.	Check that the yellow drainage pump stop (on the right in the bottom drain) is in place. See the chapter <i>Care and cleaning</i> .
	Kink in drainage hose.	Check that the hose is free from kinks and sharp bends.
	Blocked drainage hose.	Disconnect the drainage hose where it connects to the sink unit's water trap. Check that no debris has fastened and that the connection has an inner diameter of at least 14 mm.
Bad odour in dishwasher.	Dirt around the seals and in corners.	Clean with washing-up brush and low foaming cleaner.
	Low temperature programs have been selected for a prolonged period.	Run a program with a high temperature once or twice a month. Or run a self-cleaning program. See Self-clean in the chapter <i>Using the dishwasher</i> .
Grease deposits in the dishwasher.	Low temperature programs have been selected for a prolonged period.	Select a program with a high temperature to dissolve grease on very dirty dishes, such as Intensive 70°. Or run a self-cleaning program. See Self-clean in the chapter <i>Using the dishwasher</i> .
The dishes are not dry enough.	The ☞ SmartDry option is not activated.	Activate the ☞ SmartDry option.
	The dishwasher is not fully loaded.	Fully load the dishwasher.
	Rinse aid needs topping up or dosage is set too low.	Top up with rinse aid or increase the rinse aid dosage setting.
	The setting TAB is activated and all-in-one detergent with insufficient drying effect is being used.	Switch all-in-one detergents or deactivate the TAB setting and top up with salt and separate rinse aid. See Rinse aid in the chapter <i>Settings</i> .

WiFi

Problem	Possible causes	Action
The dishwasher's network symbol  does not appear on the display.	The dishwasher is not connected to your wireless network.	Connect the dishwasher to your wireless network. See the chapter <i>ConnectLife</i> .
	The WiFi connection is deactivated.	Activate the WiFi connection. See <i>Deactivate/activate WiFi connection</i> in the chapter <i>ConnectLife</i> .
WiFi connection failed	The dishwasher cannot access your wireless network. Or the router is not connected to the internet.	Check that the router is connected to the internet.
		Make sure your wireless network is using 2.4 GHz and is visible. Try moving the router closer to the dishwasher if the signal is too weak.
		See also troubleshooting at www.connectlife.io . If the problem persists, contact your nearest service centre.
Pairing failed	Your smartphone/tablet is not connected to your wireless network. Or the router is not connected to the internet.	Check that the router is connected to the internet.
		Check that your smartphone/tablet is connected to your wireless network.
		See also troubleshooting at www.connectlife.io . If the problem persists, contact your nearest service centre.
The dishwasher is shown as disconnected in the <i>ConnectLife</i> app.	The WiFi connection is deactivated	Activate the WiFi connection. See <i>Deactivate/activate WiFi connection</i> in the chapter <i>ConnectLife</i> .
		See also troubleshooting at www.connectlife.io . If the problem persists, contact your nearest service centre.
Software update failed.	The network connection was lost or the dishwasher lost power due to a power failure.	Make sure that the power supply is not interrupted and that the network connection is stable before trying again. If the problem persists, contact your nearest service centre.

Installation

It is important that you read through and follow the instructions and directions below. Conduct installation and connection in accordance with the separate installation instructions.

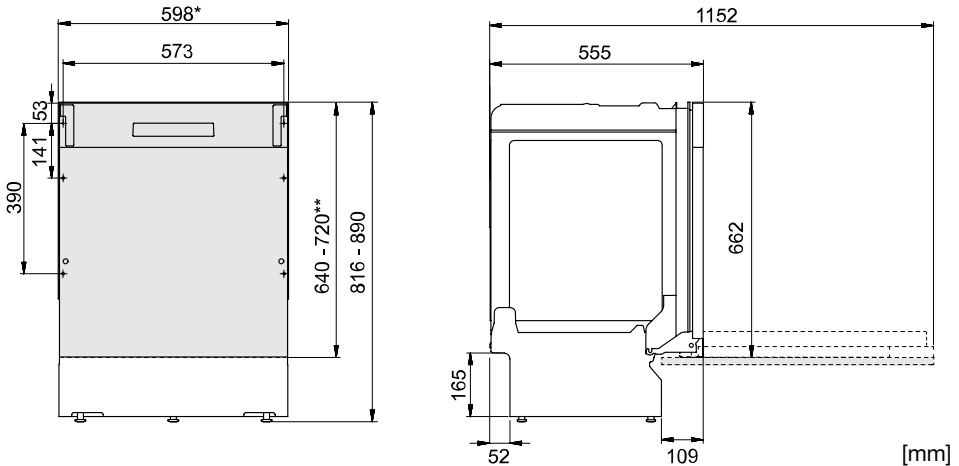

*Remove the plastic strips if the recess dimension is 596-598 mm.
Exercise caution! The edges may be sharp. Wear protective gloves!

**Cover door length.

Nominal dimensions. Actual measurements may vary.

Safety instructions

- Connections to electricity, water and drainage must be performed by a qualified professional.
- Always follow applicable regulations for water, drainage and electricity.
- Take care during installation! Wear protective gloves! There must always be two people!
- Place a drip tray on the floor beneath the dishwasher to prevent damage from any water leaks. (If required by your insurance company.)
- Before screwing the dishwasher into place, test the dishwasher by running the 1h 65° program with the Speed wash option. Check that the dishwasher fills with water and drains. Check also that none of the connections leak.

WARNING!

The ventilation opening in the lower part of the door must not be blocked by a rug, carpet or similar furnishing.

WARNING!

Turn off the water supply when installing the dishwasher!

The plug must be disconnected or power to the socket turned off while the work is carried out!

NOTE!

Each dishwasher is tested before delivery. Some water may remain inside the machine, which can leave a bad odour. Install the dishwasher and run a dishwashing program to remove any such odour.

Setup

- The recess and connection dimensions are included in the separate installation instructions. Check that all dimensions are correct before starting the installation. Note that the height of the cover door can be adjusted to match other fittings.
- Make sure the area on which the dishwasher is to be installed is firm. Adjust the adjustable feet so that the dishwasher is level.
- If the dishwasher is built-in the surrounding furnishings must be resistant to any condensation from the dishwasher.
- Mount the protective film beneath the worktop and up around the edge. The function of the protective film is to protect the worktop from moisture. (The protective film is in the enclosed plastic bag.)
- Check that the machine is installed such that the door opens freely, otherwise door lock functionality may be disrupted.
- Note that the door springs may need adjusting after a cover door has been fitted. Adjust the left and right door springs equally until the door is evenly balanced.

Drainage connection

This dishwasher is suitable for installing in a raised recess (to attain an ergonomic working height). This means that the dishwasher can be placed so that the drainage hose runs to a lower level than the bottom of the dishwasher, such as by routing it directly to a floor drain.

The drainage hose can also be connected to a connection nipple on the sink unit's water trap. The connection nipple must have an internal diameter of at least 14 mm.

The drainage hose may be extended by a maximum of 3 m (the total length of the drainage hose must not exceed 4.5 m). Any joints and connecting pipes must have an internal diameter of at least 14 mm.

No part of the drainage hose may be more than 950 mm above the bottom of the dishwasher.

Attach the drainage hose with a hose clamp. Ensure that the drainage hose has no kinks.

Connection to water supply

Use only the inlet hose supplied with the dishwasher. Do not re-use old or other spare hoses.

The supply pipe must be fitted with a water tap (stopcock). The water tap must be easily accessible, so that the water can be shut off if the dishwasher has to be moved.

Once the installation is complete, turn on the water tap and allow the pressure to settle for a while. Check that all connections are watertight.

Connection to cold water supply

Connect the dishwasher to the cold water supply if the building is heated using oil, electricity or gas.

Connection to hot water supply

Connect the dishwasher to the hot water supply (max. 70 °C) if the building is heated using an energy-efficient means such as district heating, solar power or geothermal power. Choosing a hot water connection reduces the dishwasher's energy consumption.

**NOTE!**

Do not exceed the permitted water supply temperature. Certain materials used in some cookware cannot withstand high heat. See *Fragile dishes* in the chapter *Loading the dishwasher*.

Electrical connection

Information about the electrical connection can be found on the serial number plate. This specification must match the electricity supply.

The dishwasher must be connected to an earthed socket.

The electric wall socket must be placed outside of the installation area to be easily accessible after installing the dishwasher. Do not use an extension cord!

**NOTE!**

Connection to electricity, as well as maintenance, must be performed by a qualified professional.

Service

Read the chapter *Troubleshooting* before contacting the service centre. If you have encountered a problem that you cannot resolve, please contact your nearest service centre for professional help.

Phone: 400 808 8899

When making contact, provide the details on the serial number plate. Include the article number (1) and the serial number (2).

Please note that non-professional repairs may risk user safety and affect the warranty.

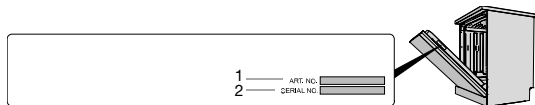

Number of program cycles

Press and hold  and  for 3 seconds to show Number of program cycles on the display.

(If the dishwasher has completed more than 999 cycles, the number of thousands is displayed followed by the number of cycles up to 999. For example: 1234 cycles is displayed as 001 followed by 234.)

Technical information

Technical data

Height:	816-890 mm
Width:	598 mm
Depth:	555 mm
Weight:	30 kg ¹⁾
Number of place settings:	16
Water pressure:	0.03-1.0 MPa
Electrical connection:	See the serial number plate
Rated power:	See the serial number plate

¹⁾ *Weight can vary due to different specifications.*

gorenje

www.gorenje.com



881005-a3

We reserve the right to make changes.