



USER MANUAL

Dishwasher

EN

DFI777UXXL

Contents

Your dishwasher	3	ConnectLife	28
Safety instructions	4	Connect to a network and pair	28
Child lock	5	Remote control the dishwasher	29
Installation	5	Remote start the dishwasher	29
Overflow guard	5	Pair more devices	29
Packaging	5	WiFi connection Off / WiFi connection On	29
Disposal	5	Remove all devices	29
Symbols on the appliance	6	Settings	30
Before washing for the first time	7	Care and cleaning	34
Water hardness	7	Top up rinse aid	34
Basic settings	8	Top up salt	34
Top up rinse aid	9	Top up auto dose	34
Top up salt	9	Clean the automatic dosing compartment ...	34
Top up auto dose	10	Clean the filters	35
Greener dishwashing	11	Cleaning the spray arms and spray pipes ...	36
Save energy and water	11	Clean the outside of the dishwasher	37
Loading the dishwasher	12	Run Self-cleaning	38
Fragile dishes	12	Remove blockages	38
Loading affects the results	12	Winter storage/Transport	39
The dishwasher's baskets	13	Troubleshooting	40
Top cutlery tray	13	General	41
Upper basket	14	WiFi	47
Middle basket	16	Installation	48
Lower basket	17	Safety instructions	48
Cutlery basket	19	Setup	49
Using the dishwasher	20	Drainage connection	49
Add detergent	20	Connection to water supply	49
On/Off	21	Electrical connection	50
Select program	21	Push to open	50
Select program mode	23	Service	51
Select option	24	Information about your product	51
Start/Stop	24	Contact your nearest service centre	51
Status light	25	Number of cycles	51
If you want to load more dishes	25	Technical data and energy labelling	52
Power failure	25	Technical data	52
Once the program has finished	26	Information for consumers	52
The best drying results	26	Information for test institute	52
Unloading the dishwasher	26	Declaration of conformity	52
Program chart	27		

Your dishwasher

Welcome to our growing ASKO family!

We are proud of our appliances. We hope that this appliance will be an appreciated and dependable aid for many years to come.

Please read the operating instructions before use. They include general tips, information about the settings and adjustments you can make, and the best way to take care of your appliance.

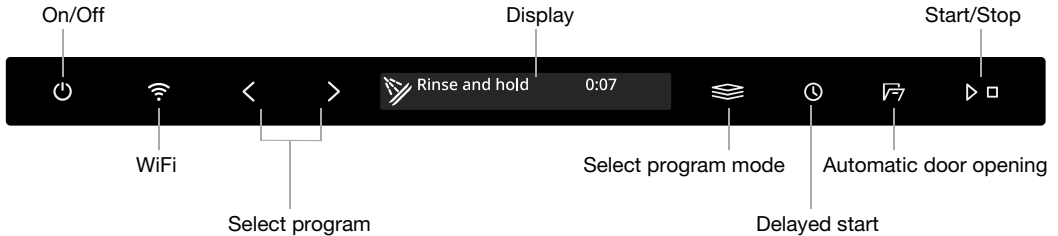

Symbols on the display:

- ☼ Top up rinse aid
- ☼ Top up salt
- Auto dose
- ⌚ Top up auto dose

- ☼ Connected to cloud (Flashes when connecting)
- ☼ Remote control active

Text on the display:

- Clean the filters
- Run Self-cleaning
- See the chapter *Care and cleaning*.

Install the dishwasher, see the chapter *Installation*. Then open the door and press .

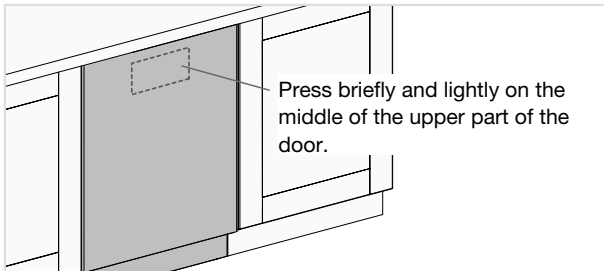

"Welcome to your new ASKO dishwasher. This is a first time setup." is shown on the display the first time the dishwasher is switched on. It is important that you choose the right settings to ensure good dishwashing results. See page 7.

You can remote control this dishwasher with your smartphone/tablet. Connect the dishwasher to your wireless network and pair with your smartphone/tablet to be able to remote control and start the dishwasher using the *ConnectLife* app. The app can be used to find information, change settings and monitor the dishwasher. (The dishwasher can always be used without the app.)

Safety instructions

- Read the user manual and keep it in a safe place!
- Number of standard place settings: 17
- Never use the dishwasher for any purpose other than that specified in these operating instructions.
- Do not load the dishwasher door or dishwasher baskets with anything other than dishes.
- Never leave the dishwasher door open as someone may trip on it. Push the baskets in to avoid risking the dishwasher tipping over.
- Use only dishwasher detergent!
- This machine can be used by children aged 8 and upwards, and by people with reduced physical capacity, mental ability, memory loss or lacking experience and knowledge. These individuals must be supervised when using the machine or have instructions on how to use the machine and understand the risks that can occur. Cleaning of the machine must not be carried out by children without supervision.
- Damaged supply cord must only be replaced by the manufacturer's service centre or someone similarly professionally qualified.
- Only use the dishwasher in household-type environments for dishwashing household dishes. All other use is prohibited.
- Never place dishes with solvent residues in the dishwasher due to the risk of explosion. Nor may dishes that contain ash, wax or lubricants be washed in the dishwasher.
- Children must be watched. Do not allow children to use or play with the dishwasher. Be especially vigilant when the door is open. Some detergent may remain inside! After adding detergent, always start the dishwasher immediately.
- The dishwasher is equipped with a UVC light source. A damaged or defective UVC light source may only be replaced by the manufacturer's service centre or someone similarly professionally qualified.



WARNING!

Knives and other pointed items must be placed with the points down in the cutlery basket or horizontally in other baskets.

WARNING!

Children must be supervised – dishwasher detergent is corrosive!

Child lock

You can activate the Automatic child lock setting to prevent children from starting the dishwasher. See the chapter *Settings*. You can also temporarily activate and deactivate the Child lock function. Press and hold  and  for three seconds.

Installation

See the chapter *Installation*.

Overflow guard

The overflow guard starts pumping out the water and turns off the water supply if the water level in the dishwasher exceeds the normal level. If the overflow guard is triggered, F54 (Overfilling water) appears on the display. Turn off the water tap and contact your nearest service centre. (To avoid water leakage outside the dishwasher, do not remove the plug from the wall socket until the water tap on the supply line has been turned off!)

Packaging

The outer packaging protects the product during transport. The packaging material is recyclable. Separate the different packaging materials to help reduce raw material use and waste. Your dealer can take the packaging for recycling or direct you to the nearest recycling centre. The packaging is comprised of:

- Corrugated cardboard made from up to 100% recycled material.
- Expanded polystyrene (EPS) with no added chlorine or fluorine.
- Supports made from untreated wood.
- Protective plastic made from polyethylene (PE).

Disposal

The dishwasher is manufactured and labelled for recycling. When the dishwasher has reached the end of its service life and is to be disposed of, it should immediately be made unusable. Pull out the power cable and cut it as short as possible. Remove the light source/light sources.

Contact your local authority for information about where and how your dishwasher should be correctly recycled.

Safety instructions

Symbols on the appliance



Read the user manual.



Recycle as electrical waste.

CE Approved in accordance with the relevant EU directives.



Approved in accordance with the relevant UK legal requirements.

Before washing for the first time

Water hardness

In order to achieve good dishwashing results, the dishwasher needs soft water (water with low mineral content). Hard water leaves a white coating on dishes and the dishwasher.

Checking water hardness

Water hardness is specified using German degrees of water hardness (°dH), French degrees of water hardness (°fH), English degrees of water hardness (°eH) or millimoles per litre (mmol/l).

A water supply with a water hardness in excess of 5°dH (9°fH / 6°eH / 0.9 mmol/l) must be softened. This is done automatically with the aid of the built-in water softener. In order for the water softener to function properly, its settings must be adjusted to the hardness of the water supply. Once you have adjusted the water softener settings, add detergent and rinse aid in doses suitable for soft water.

Contact the local waterworks to check the water hardness in your area.

Make a note of the water hardness: _____

°dH	°fH	°eH	mmol/l	Recommended setting
0-5	0-9	0-6	0.0-0.9	0
6-8	10-14	7-10	1.0-1.4	1
9-11	15-20	11-14	1.5-2.0	2
12-14	21-25	15-18	2.1-2.5	3
15-19	26-34	19-24	2.6-3.4	4
20-24	35-43	25-30	3.5-4.3	5
25-29	44-52	31-36	4.4-5.2	6
30-39	53-70	37-49	5.3-7.0	7
40-49	71-88	50-61	7.1-8.8	8
50	89	62	8.9	9

If the water hardness exceeds 50°dH (89°fH / 62°eH / 8.9 mmol/l), we recommend connecting an external water softener.

Increased consumption during regeneration

The dishwasher's built-in water softener is regularly regenerated to maintain its function. Regeneration extends the dishwashing program and increases energy and water consumption. Just how often the dishwasher's water softener is regenerated depends on the selected setting.

Example: If the Eco program is run with a water hardness of 14°dH (25°fH / 18°eH / 2.5 mmol/l), the water softener is regenerated at regular intervals (after 6 dishwashing cycles), energy consumption increases by 0.015 kWh, and water consumption increases by 2.3 litres, while the program time is extended by 3 minutes. Regeneration takes place during the program's main wash.

Before washing for the first time

WARNING!

Hard water leaves a white coating on dishes and inside the dishwasher. It is therefore important that you select the right setting for the water softener! See Water hardness.

Never run the dishwasher with an empty salt compartment if the water supply has a water hardness in excess of 5°dH (9°FH / 6°eH / 0.9 mmol/l).

Basic settings

Open the door. Press .

"**Welcome to your new ASKO dishwasher. This is a first time setup.**" is shown on the display. It is important that you choose the right settings to ensure good dishwashing results.

Select setting with < or >. Confirm selected setting with .

Settings		
1.	Language	Select the language to be shown on the display.
2.	Rinse aid 0/1/2/3/4/5 <i>Pre-selected at factory: 4</i>	Drying is faster and a better result is achieved if you use rinse aid. You will also achieve a better dishwashing result with clear and spotless dishes. The rinse aid dispenser can be adjusted between 0 (Off) and 5 (High dosage).
3.	Water hardness 0/1/2/3/4/5/6/7/8/9 <i>Pre-selected at factory: 4</i>	Adjusting the water softener. Select a setting depending on the hardness of the water supply. It is important that this setting is correct! For a water supply with a hardness above 5 °dH (9 °fH / 6 °eH / 0.9 mmol/l), fill with salt. <i>For a water supply with a hardness below 6°dH (10°FH / 7°eH / 1.0 mmol/l), select 0. The water softener is deactivated and no salt needs to be added.</i>
4.	TAB On/Off (All-in-one detergent) <i>Pre-selected at factory: Off</i>	Activate this setting when using an all-in-one detergent that contains rinse aid. This setting reduces the rinse aid dosage and affects how often the dishwasher's built-in softener is regenerated.
5.	Auto dose Off, 15-40 ml <i>Pre-selected at factory: Off</i>	Activate this setting if you want to use automatic dosing of detergent. The exact dosage depends on which program is running. For the Auto program, the dosage also depends on how dirty the dishes are.

To change the selected setting, see the chapter Settings.

Before washing for the first time

* Top up rinse aid

Top up the rinse aid compartment with rinse aid if you have selected Rinse aid 1 - 5.

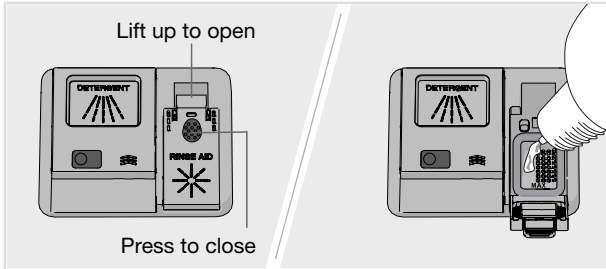

1. Open the rinse aid compartment lid.
2. Carefully top up with rinse aid to the level marked **MAX**.
3. Wipe up any splashes of rinse aid around the compartment.
4. Close the lid firmly.

§ Top up salt

For a water supply with a hardness above 5 °dH (9 °fH / 6 °eH / 0.9 mmol/l), fill with salt.

Add salt to the salt compartment if you have selected Water hardness 1 - 9.

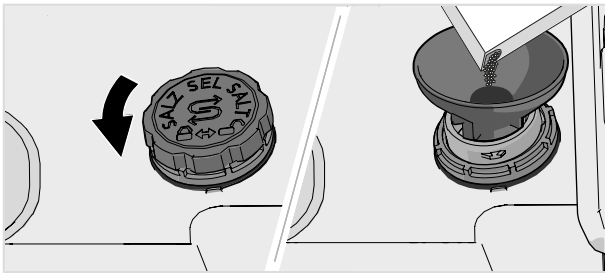

1. Remove the salt compartment lid by turning it anticlockwise.
2. Place the funnel supplied with the dishwasher in the salt compartment top-up hole. Before washing for the first time, pour in about 1 l of water. (Water is only needed the first time.)
3. Add enough salt to fill the salt compartment (max. 750 gram). Use special dishwasher salt.
4. Wipe away excess salt and turn the lid clockwise until in the closed position.

⚠ WARNING!

In order to avoid rust stains a dishwashing program must be started immediately after adding salt.

Never pour dishwasher detergent into the salt compartment. This destroys the water softener!

Before washing for the first time

Top up auto dose

Fill the automatic dosing compartment with dishwasher detergent gel if you have activated the Auto dose setting.

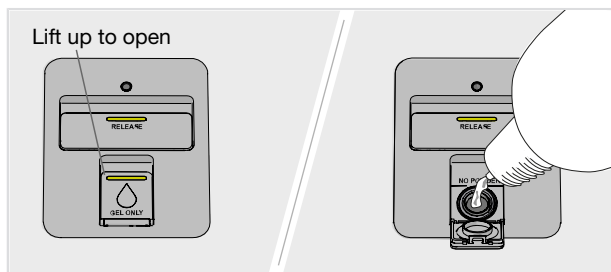

1. Open the lid of the automatic dosing compartment for dishwasher detergent gel.
2. Carefully add dishwasher detergent gel to the level marked **MAX**.
3. Clean up any excess dishwasher detergent gel outside the compartment.
4. Close the lid firmly.

NOTE!

Use only dishwasher detergent gel in the automatic dosing compartment! Do not use dishwasher detergent powder. Washing up liquid must not be used as the foam that forms prevents the dishwasher from operating effectively.

Some thick dishwasher detergent gels are not suitable for the automatic dosing compartment. Add very thick dishwasher detergent gel into the manual detergent compartment. See the detergent manufacturer's recommendations.

Dishwasher detergent gel has a milder formula than dishwasher detergent powder or all-in-one detergent with bleaching agent. This means that dishwasher detergent gel may prove less effective at removing stains caused by, for example, lipstick and tea/coffee. If necessary, on such occasions dishwasher detergent powder or all-in-one detergent with bleaching agent can be added to the manual detergent compartment (when Auto dose is activated). See *Add detergent*.

Dosing of dishwasher detergent gel

Dishwasher detergent gel is dispensed during the main wash for all programs except Self-cleaning. A little extra dishwasher detergent gel is also dispensed during the prewash in the following programs:

Auto, Universal, Intensive, Time program (2:00, 2:30)

Save energy and water

When using a dishwasher in a residential setting, less energy and water are generally used compared to washing the dishes by hand.

Do not rinse under running water

Do not rinse the dishes under running water as this will lead to increased energy and water consumption. Simply scrape off large food particles before loading the dishwasher.

Choose a green detergent

Read the environmental declaration on the packaging!

Too much detergent, rinse aid and salt can result in less effective dishwashing and also entail greater environmental impact.

Run a fully loaded dishwasher

Save energy and water by waiting until the dishwasher is full before running a program (see number of standard place settings). Use the Rinse and hold program to rinse the dishes if there are any unpleasant odours.

You can also use the Anti-odour program to prevent bad odours from dirty dishes left in the dishwasher.

Run programs at a lower temperature

If the dishes are only slightly dirty, you can select a program with a low temperature.

Select dishwashing program – Eco

This program is suitable for washing normally soiled dishes and is the most effective program in terms of combined energy and water consumption. This program is used to assess compliance with EU legislation on ecodesign.

The dishwashing program is designed for an effective wash using as little energy and water as possible. The program washes at a low temperature for a long time.

Select option – Automatic door opening

Better drying results are achieved if you use the Automatic door opening option, which automatically opens the dishwasher door. Wait until the dishwasher indicates that the programme has ended and the dishes have cooled before unloading the dishwasher.

Connect to cold water

Connect the dishwasher to the cold water supply if the building is heated using oil, electricity or gas.

Connect to hot water

Connect the dishwasher to the hot water supply (max. 70 °C) if the building is heated using an energy-efficient means such as district heating, solar power or geothermal power. Choosing a hot water connection reduces the dishwasher's energy consumption.

NOTE!

Do not exceed the permitted water supply temperature. Certain materials used in some cookware cannot withstand high heat. See *Fragile dishes* in the chapter *Loading the dishwasher*.

Loading the dishwasher

Fragile dishes

Some cookware is not dishwasher safe. This can be for several reasons. Some materials cannot withstand high heat, others can be damaged by dishwasher detergent.

Exercise caution with, for example, handmade items, fragile decoration, crystal/glassware, silver, copper, tin, aluminium, wood and plastic. Look for the "Dishwasher safe" marking.

Fragile decoration

Porcelain with decoration on top of the glazing (the items feel rough) should not be washed in a dishwasher.

Crystal/Glass

Wash fragile items made of crystal/glass using the gentle dishwashing program Crystal glass. Remember to use a small amount of detergent and to place items so that they do not touch each other during the wash.

Drying is faster and a better result is achieved if you use rinse aid. You will also achieve a better dishwashing result with clear and spotless dishes.

Hand-painted glassware, as well as antique and very fragile items, should not be washed in a dishwasher.

Silver

Silver and stainless steel items should not come into contact, as the silver can become discoloured.

In order to avoid marks and tarnishing, separate dishes made from different metals, such as silver, stainless steel and aluminium.

Aluminium

Aluminium can lose its shine if washed in a dishwasher. However, good quality aluminium pans can be washed in a dishwasher, even if some of the shine will be lost.

Cutlery with glued handles

Some types of glue are not dishwasher safe. In such cases, the handles may loosen.

Loading affects the results

Load the dishes carefully to ensure the best washing and drying results with the lowest possible energy and water consumption. Give your dishwasher the best chance to reach and clean all surfaces, as well as to dry the dishes as thoroughly as possible.

- All dirty surfaces should face inwards and downwards!
- Dishes should not be placed in or on each other.
- Angle dishes with hollows, such as cups, so that the rinse water will run off. This is also important for plastic items.
- Make sure small items cannot fall through the dishwasher basket; place them in the top cutlery tray.

NOTE!

Check that the spray arms can rotate freely.

The dishwasher's baskets

The dishwasher is equipped with a top cutlery tray, an upper basket, a middle basket and a lower basket with a cutlery basket.

The appearance of the baskets may differ depending on the dishwasher setup.

Top cutlery tray

The top cutlery tray has space for cutlery, ladles, whisks, serving cutlery and similar items.

Avoid placing tall objects in the top cutlery tray. They can block the top spray arm.

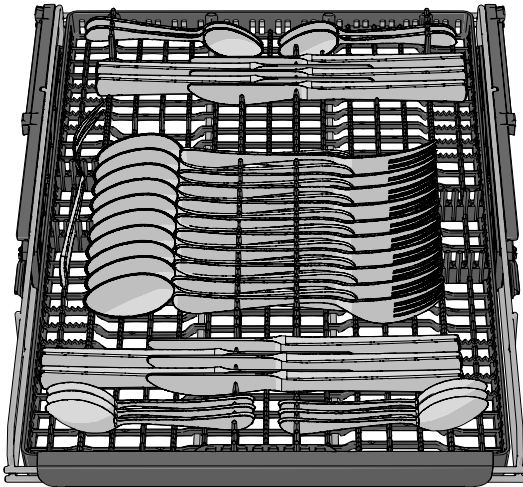

Raising the top cutlery tray

1. Pull out the top cutlery tray.
2. Pull forward the two locking handles on either side to raise the top cutlery tray.

Lowering the top cutlery tray

1. Make sure the upper basket is in the lowest position.
2. Pull out the top cutlery tray.
3. Slide the two locking handles on either side downwards and backwards to lower the top cutlery tray.

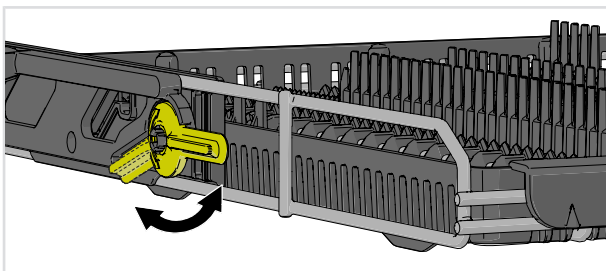

Loading the dishwasher

Upper basket

Place glasses, cups, bowls, side plates and saucers in the upper basket. All dirty surfaces should face inwards and downwards! Wine glasses are placed on the wine glass shelf and knives are placed in the knife stand on the right.

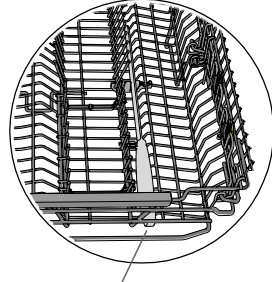
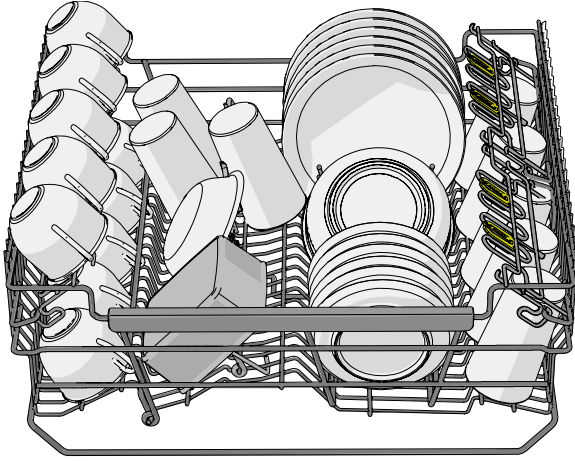

Knife stand

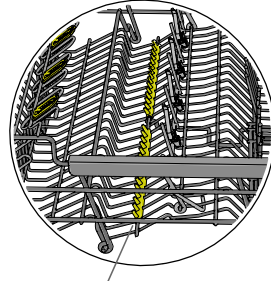
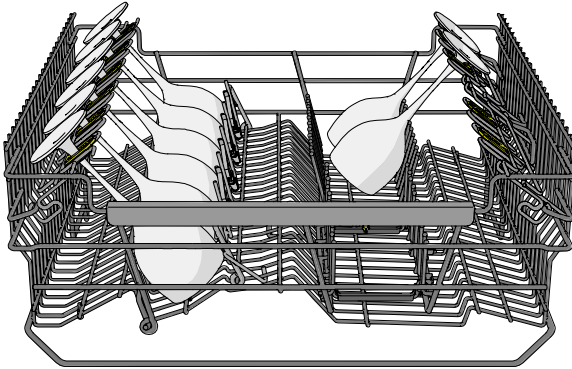

Wine glass supports

Adjustable plate supports

The adjustable plate supports can be pushed together to suit the dishes.

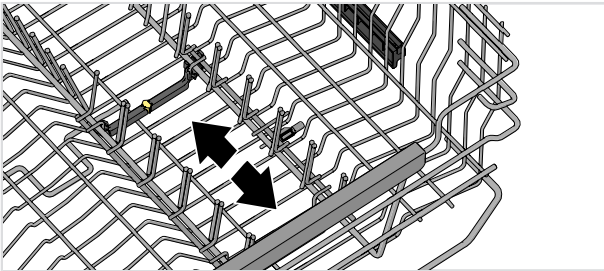

Raising the upper basket

1. Pull out the upper basket.
2. Grab the sides of the upper basket with both hands and lift it up.

Lowering the upper basket

1. Pull out the upper basket.
2. Grab the sides of the upper basket with both hands and push in the two locking handles to lower the upper basket.

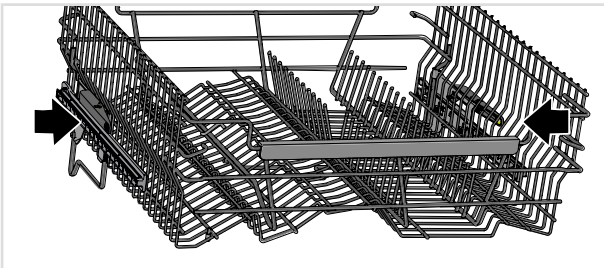

Loading the dishwasher

Middle basket

The middle basket comes with two different basket inserts. The insert with spray pipes is suitable for low items. The cutlery insert has space for ladles, whisks, serving cutlery and similar items.

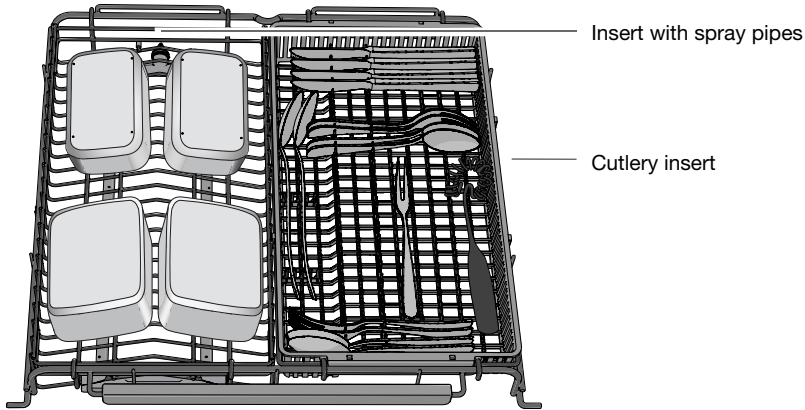

Washing larger items

If large items are to be washed in the lower basket, either the middle basket's two inserts can be removed or the entire middle basket can be lifted out. To remove the entire middle basket, grab the sides of the middle basket with both hands and lift both sides at the same time. To refit, simply reverse the procedure.

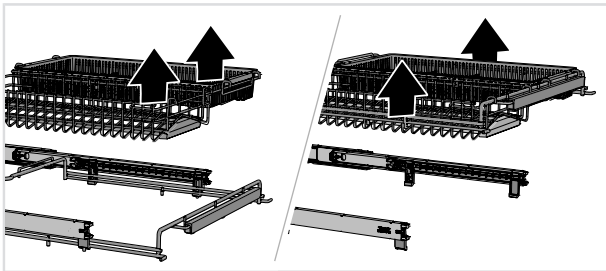

Accessory

Buy an extra insert with spray pipes for your middle basket, then you can wash more low items, such as glasses, cups and bowls. This accessory is available where you bought the dishwasher.

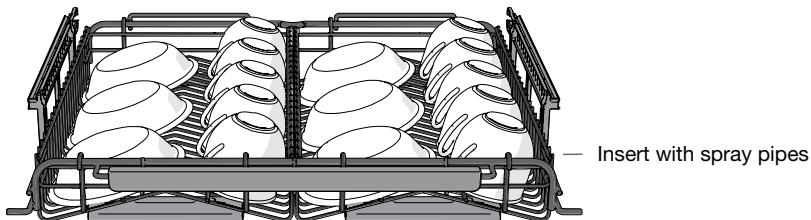

Lower basket

Place plates, side plates, serving dishes, pots and cutlery (in the cutlery basket) in the lower basket.

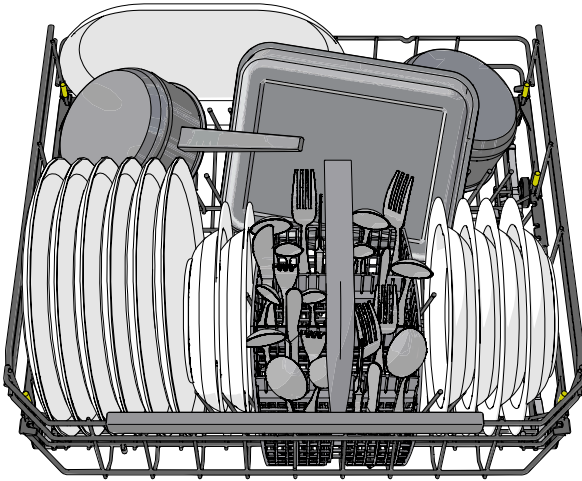

Adjustable plate supports

The adjustable plate supports can be adjusted to suit the dishes. Release the plate supports by pushing them inwards before repositioning them. The plate supports can also be folded down to make it easier to load pots and bowls.

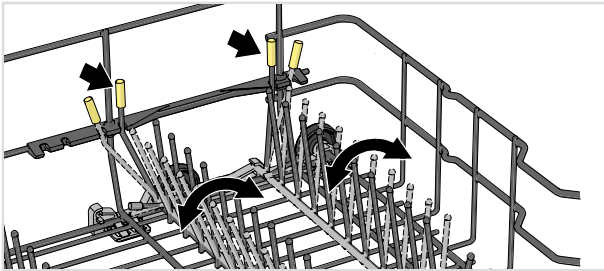

At the back of the right side of the lower basket, the plate supports can be pushed together to provide more space for, for example, stoneware or a deep pan.

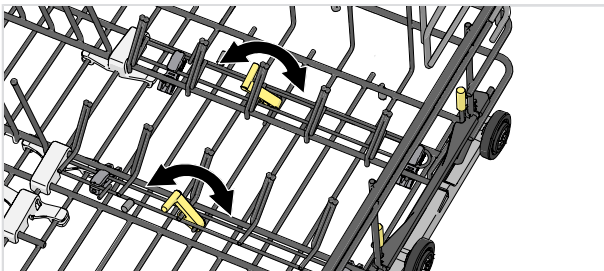

Loading the dishwasher

Vase and bottle holder

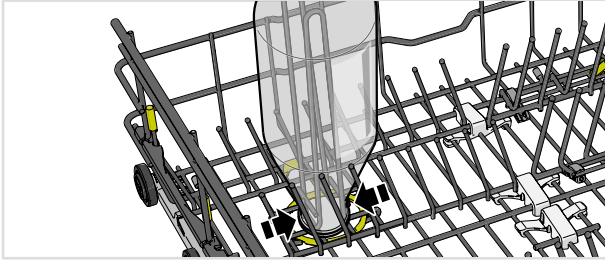

Adaptable power zones

The dishwasher's two adaptable power zones can be opened in two different positions or turned off.

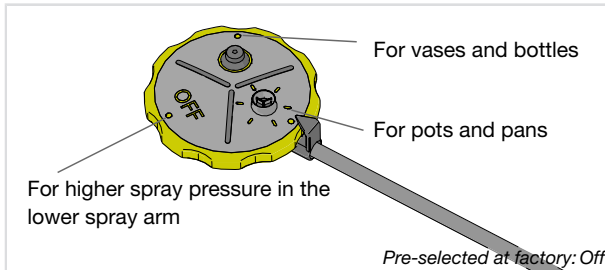

Leave the power zones open if you want an increased water flow where, for example, you have placed pots and pans or vases and bottles. Turn the dishwasher's power zones off if you want greater spray pressure in the lower spray arm.

Washing large plates

You can adjust the lower basket for plates with a diameter of 25-29 cm by moving the adjustable plate supports and their fixtures to increase the distance between the tine rows.

Accessory

Buy a wine glass shelf with space for six tall¹⁾ wine glasses. The wine glass shelf is designed to ensure optimal washing and drying results with tall wine glasses. The wine glass shelf is placed in the rear section of the lower basket. This accessory is available where you bought the dishwasher.

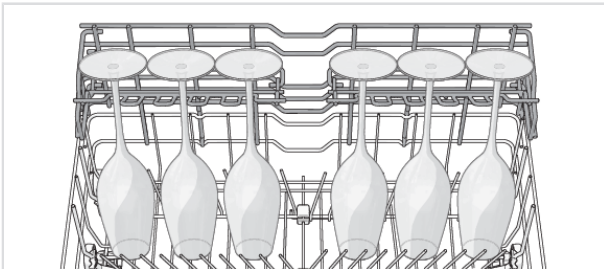

¹⁾ Height: max. 25 cm, Diameter: max. 7.5 cm

Cutlery basket

Place cutlery with the handles facing down, except for knives, and spread them out as much as possible. Ensure that spoons do not stack inside each other.

The cutlery basket is best placed in the middle at the front of the lower basket to best utilise dishwashing performance from the unique spray zone intended for the cutlery basket.

WARNING!

Knives and other pointed items must be placed horizontally in the dishwasher's special cutlery baskets.

Fold-down section for small items

The cutlery basket has a fold-down section in the middle for small items or small shafts (such as electric whisk attachments).

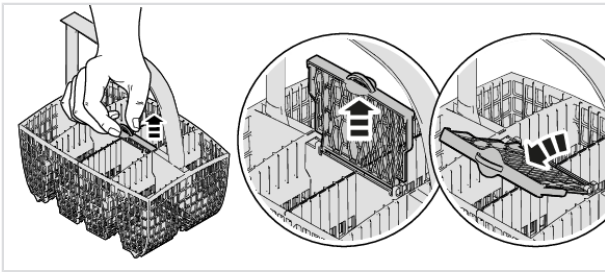

Accessory

Buy a mini cutlery basket. The extra cutlery basket is flexible and can be dismantled and attached to the lower basket or the large cutlery basket to make an extra large cutlery basket. This accessory is available where you bought the dishwasher.

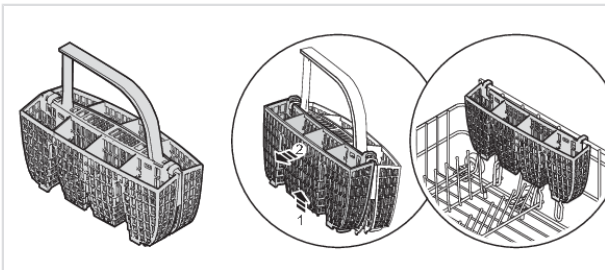

Using the dishwasher

Add detergent

You have two options for adding detergent – manual or automatic. To activate Auto dose, see the chapter *Settings*. The manual detergent compartment can be used as a supplement even when Auto dose is activated (e.g. for dishwasher detergent with bleaching agent or if the automatic dosing compartment is empty).

Follow the instructions on the detergent packaging. This dishwasher is fitted with a water softener, so use detergent and rinse aid doses suitable for soft water.

Do not add detergent to the manual detergent compartment when using automatic detergent dosing! Too much detergent can result in less effective dishwashing and also entails greater environmental impact.

Manual detergent compartment

The detergent compartment must be dry when adding detergent.

If powder or liquid dishwasher detergent is used, add a small amount of the detergent to the compartment for prewash detergent.

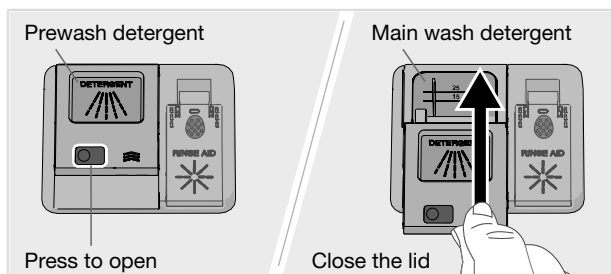

NOTE!

Use only dishwasher detergent! Washing up liquid must not be used as the foam that forms prevents the dishwasher from operating effectively.

All-in-one detergent

There are many types of all-in-one detergents on the market. Read through the directions for these products carefully.

Activate the TAB setting when using an all-in-one detergent that contains rinse aid.

Dishwasher tablets are not recommended for short programs (less than 75 minutes). Use powder or liquid dishwasher detergent instead.

NOTE!

Optimal washing and drying results are achieved by using normal detergent together with separately dispensed rinse aid and salt.

Contact the detergent manufacturer if you have questions about the detergent.



Using the dishwasher



On/Off

Open the door and press . Also turn on the water tap if it is turned off.

Select program

Eco is always pre-selected. To select another program, press  or  until the desired program is shown on the display.

Select a program to suit the type of dishes and how dirty they are.

Eco

This program is suitable for washing normally soiled dishes and is the most effective program in terms of combined energy and water consumption. This program is used to assess compliance with EU legislation on ecodesign.

You can read more about greener dishwashing in the chapter *Greener dishwashing*.

For heavily soiled dishes with a lot of grease, a program with higher temperatures should be used.

Auto

The dishwasher can measure how dirty the dishes are and adjust water consumption and temperature accordingly. When newly installed, the program needs to be run five times before it is fully adapted and can provide the best results.

If Auto dose is activated, the dosage of dishwasher detergent gel is also adjusted.

Universal

An effective program for daily use for slightly dried leftovers. (This program is not intended for burnt food, such as on oven dishes.)

Intensive

A program with a high temperature for dissolving grease on very dirty dishes, such as pans, casserole dishes and oven dishes. If these dishes do not completely fill the dishwasher, you can add plates and other dishes.

Using the dishwasher



Quick pro²⁾

A fast and effective program for slightly dried leftovers. (This program is not intended for burnt food, such as on oven dishes.)

The Automatic door opening option is important for ensuring the best drying results.



Preheated (30 min + 20 min)

A dishwashing program with a preheating phase (the water is heated for 30 min) and a dishwashing phase (the dishes are washed for 20 min). This program is designed to offer you a quick dishwashing program that can be started within 180 minutes of the preheating phase ending.

Step 1: To start the preheating phase, press ▶ □. Close the door. (The spray arms rotate and the status light is red while the water is being preheated.) Wait until the status light turns blue. When you open the door, the display shows "Preheating phase completed", indicating that the dishwashing phase is ready to be started within 180 minutes.

You can load the dishes throughout the preheating phase. This program is not intended for dried leftovers. Remember to scrape off larger food particles before loading the dishwasher.

Step 2: To start the dishwashing phase, press ▶ □.



Crystal glass

A gentle dishwashing program with a low temperature for washing fragile items made of crystal/glass. Remember to use a small amount of detergent and to place items so that they do not touch each other during the wash. See also *Fragile dishes* in the chapter *Loading the dishwasher*. Porcelain that has just been used without dried leftovers can also be washed using this program.



Time program

The program adapts to the specified running time or finish time. With this program it is important to choose a time suited to how dirty the dishes are.

Press ⌚ to set the desired program time.

0:15-0:45	Slightly dirty dishes
1:00-1:30	Normally dirty dishes
2:00-2:30	Very dirty dishes



Hygiene

This program is ideal to use where demands on hygiene are extra high, e.g. for baby bottles and cutting boards. The temperature is high both in the main wash and in the final rinse.



Plastic

A program intended for washing plastic items that are dishwasher safe. This program has an extra long drying cycle. Porcelain and glasses can also be washed.

²⁾ When combined with Speed, the program is shortened (39 minutes).



Rinse and hold

Used to rinse dishes while you wait for the dishwasher to become fully loaded.



Self-cleaning

Self-cleaning program for hygienic cleaning of the dishwasher tub, spray arms and spray pipes.

This program should be run (with no dishes in the machine) using normal dishwasher detergent or citric acid – add it to the dishwasher's manual detergent compartment. (Detergent is not automatically dispensed with the function Auto dose.) Special dishwasher cleaners are also available on the market. For the removal of limescale deposits, see *Dishwasher tub* in the chapter *Care and cleaning*.



Lower half

You can use this program when you only want to wash plates and cutlery in the lower basket. Slightly dirty dishes can also be placed in the upper basket.



Upper half

You can use this program if you only have cups and glasses that need washing in the upper basket. Slightly dirty dishes can also be placed in the lower basket.

72h



Anti-odour³⁾

This program prevents bad odours from dirty dishes left in the dishwasher. Only the dishwasher's fan is activated (at regular intervals during a period of 72 hours).



Select program mode

Press  to scroll through the available program modes. The symbol is dimly lit in available program modes, and glows brighter when a program mode has been activated. (The program modes you can select vary between programs.)

▶▶ Speed

The program time is shortened, but the dishwasher uses more energy.



Green

The dishwasher uses less energy and water.



Night

Lower noise level during the dishwashing program. The program time is extended.



Intensive

The higher temperature dissolves grease on very dirty dishes, but the dishwasher consumes more energy and water. The program time is extended.





UV cleanse

The water in the final rinse is sanitised with UV light and heat to kill microorganisms. The dishwasher uses more energy and the program time is extended.

³⁾ Activate Odour control in the dishwasher's Settings menu. See the Settings chapter.

Using the dishwasher

Select option

Available options are dimly lit. Select the options ( , ) to activate them. The options glow brighter when activated. (The options you can select vary between programs.)

Automatic door opening

The dishwasher door opens automatically, which shortens the program time and improves the drying results. Wait until the dishwasher indicates that the program has ended and the dishes have cooled before unloading the dishwasher.

The drying time of the Automatic door opening option varies (from 5 to 90 minutes) depending on the model, program and temperature of the final rinse.

The Automatic door opening option is pre-selected for some programs.



NOTE!



For the best drying results, do not close the door before the drying phase has finished and the machine has automatically switched off.



WARNING!

The dishwasher door must not be blocked or closed when opened automatically. Doing so may damage the door lock mechanism. Wait at least 5 minutes before closing the door.



Delayed start

When you select Delayed start, the dishwasher will start 1-24 hours after you have pressed   and closed the door.

1. Press  once to activate Delayed start. Press several times, or hold it in, to set the desired number of hours.
2. Press   and close the door. The timer counts down and the dishwasher starts after the selected delay.

If you want to cancel the Delayed start option, open the door then press and hold   for three seconds.





Start/Stop

Press   until the display shows "Program started, close door". This indicates that the dishwasher is ready to start. Close the door properly, otherwise the dishwasher will not start.

If the dishwasher is not started or the door is not closed within 2 minutes of the last time the control panel was pressed, the machine switches off.

To remote start the dishwasher, see the chapter *ConnectLife*.

Stopping or changing a program

If you want to change program after starting the dishwasher, open the door then press and hold   for three seconds. Add more detergent if the lid of the detergent dispenser has opened. Then select a new program, press   and close the door.

Remaining time

Once you have selected a program, program mode and options, the time the program took when last used is displayed.

Status light

The status light at the bottom on the dishwasher provides information by means of 3 different colours.

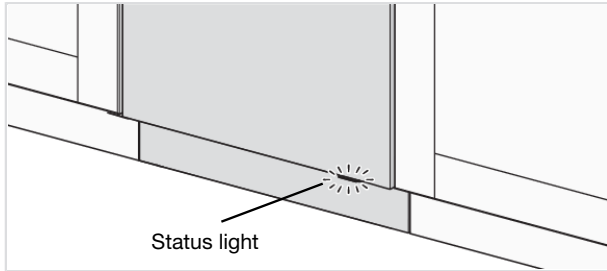

Blue - Load more

The program has started, but you can still load more dishes.

Red - Do not load

You should not load more dishes (risk of poorer dishwashing result).

Green - Unload

The dishwashing program is finished. The status light stays on for 15 minutes.

Flashing red

A flashing light indicates that the door has been opened while a program is in progress. If it flashes when the door is closed, an error has occurred. See the chapter *Troubleshooting*.

Flashing blue/green

The status light flashes blue/green to indicate that remote start is activated.

If you want to load more dishes⁴⁾

Open the door. The dishwasher stops automatically. Add the dishes and close the door. After a while, the dishwasher continues the program.

If the dishwashing program was remote started, the interrupted program will continue once the door is closed. You can monitor the dishwasher using the *ConnectLife* app and remote stop the program, although you will not be able to remote start it again.

Power failure

If the dishwasher is turned off due to a power failure when a dishwashing program is running, the program continues when power is restored. If the power is cut during drying, the program is interrupted.

If the dishwashing program was remote started and has not ended, the program will continue once the power is restored. You can monitor the dishwasher using the *ConnectLife* app and remote stop the program, although you will not be able to remote start it again.

⁴⁾ You should not load more dishes if the status light is red.

Using the dishwasher

The door can be opened manually if the dishwasher is not connected to the electrical supply. Grasp the door on both sides at the top and pull it straight out.

If you open the door for more than 2 minutes during drying, the program will be interrupted.

Once the program has finished

The end of the program is indicated by one short signal from the buzzer. The chapter *Settings* describes how to change this function.

Moreover, the end of the program is indicated by the status light turning green.

Once the dishwasher door is opened and the program has finished "Program done" appears on the display.

The dishwasher switches off automatically after the program ends. Shut off the water tap after each use (if required by your insurance company).

The best drying results

- Fully load the dishwasher.
- Angle dishes with hollows, such as cups, so that the rinse water will run off. This is also important for plastic items.
- Top up with rinse aid or increase the rinse aid dosage setting.
- Activate the Automatic door opening option.
- Allow the dishes to cool before unloading the dishwasher.

Unloading the dishwasher

Hot porcelain is more fragile. Leave the dishes to cool in the dishwasher before unloading them.

Unload the lower basket first to avoid any water drops from the upper basket falling onto the dishes in the lower basket.

Program	Program mode / Option	Number of prewashes	Main wash	Number of rinses	Final rinse	Consumption values 1)				Water cons. (liter)	
						Cold water 2)		Dishwashing time (approx. hrs:min)	Energy (approx. kWh)		Hot water 3)
						Dishwashing time (approx. hrs:min)	Energy (approx. kWh)				
Eco 4)	5)		49 °C	2	47 °C	3:45	0.77	3:35	0.4	9.9	
Auto	5)	1-2	50-65 °C	2-3	60 °C	2:10-3:10	0.9-1.4	1:50-2:50	0.6-1.0	12.0-19.0	
Universal	5)	1	60 °C	2	60 °C	2:40	1.1	2:20	0.7	13.0	
Intensive		2	70 °C	2	70 °C	2:50	1.6	2:30	1.2	16.5	
Quick pro	5)		60 °C	3	65 °C	0:59	1.1	0:59	0.7	15.0	
Preheated			65 °C	2	55 °C	0:30+0:20	0.9	0:20+0:20	0.6	10.0	
Crystal glass			45 °C	2	50 °C	1:40	0.7	1:20	0.4	10.5	
Time program		0-2	<65 °C	2	<65 °C	0:15-2:30	0.3-1.4	0:15-2:30	0.2-1.0	10.5-17.0	
Hygiene			70 °C	2	70 °C	1:05	1.3	0:45	0.9	11.0	
Plastic	5)	1	55 °C	2	68 °C	2:30	1.2	2:10	0.8	13.5	
Rinse and hold				1		0:07	0.01	0:07	0.01	3.5	
Self-cleaning			70 °C	2	70 °C	1:05	1.0	0:45	0.6	10.5	
Lower half		1	65 °C	2	60 °C	2:10	1.1	1:50	0.7	13.5	
Upper half		1	65 °C	2	60 °C	2:10	1.1	1:50	0.7	13.5	
Anti-odour						72:00	0.2	72:00	0.2		

1) Consumption values vary depending on the temperature of the incoming water, room temperature, load size, selected additional functions and more. The values for the Eco program are accurate, others are indicative only.

2) Connection to cold water, approx. 15 °C.

3) Connection to hot water, approx. 60 °C.

4) This program is suitable for washing normally soiled dishes and is the most effective program in terms of combined energy and water consumption. This program is used to assess compliance with EU legislation on eco design.

5) Automatic door opening

ConnectLife

ConnectLife is a smart home platform that connects people, devices and services. The ConnectLife application includes advanced digital services and carefree solutions that allow users to monitor and control appliances, receive notifications from a smartphone, and update software (supported features may vary depending on your appliance and the region/country in which you are located).

To connect your smart device, you need a home Wi-Fi network (only 2.4 GHz networks are supported) and a smartphone equipped with the application ConnectLife.



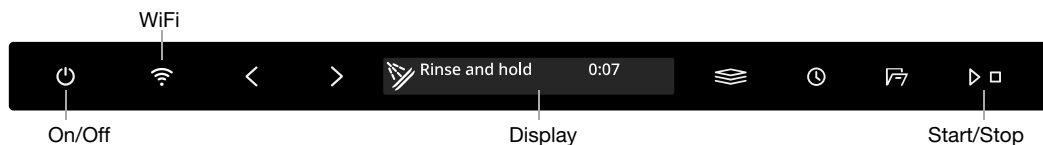

To download the ConnectLife application, scan the QR code or search for ConnectLife in your favourite app store.

1. Install the ConnectLife application and create an account.
2. In the ConnectLife application, go to the »Add devices« menu and select the appropriate type of device. Then scan the QR code (it can be found on the serial number plate of the appliance; you can also enter the AUID/SN number manually).
3. The application then guides you through the entire process of connecting the appliance to your smartphone.
4. After a successful connection, the appliance can be operated remotely via the mobile application.



Connect to a network and pair

Connect the dishwasher to your wireless network and pair with your smartphone/tablet. (This can also be done from the dishwasher's Settings menu.)

- In the ConnectLife application, go to the »Add devices« menu and select the appropriate type of device. Then scan the QR code (it can be found on the serial number plate of the appliance; you can also enter the AUID/SN number manually).
- Open the dishwasher door and press .
- On the dishwasher's control panel: Press  to activate the WiFi module.
- On the dishwasher's control panel: Press and hold  for 3 seconds to initiate *Connection setup*.

Network symbol on the display

Flashing 0.5 sec on/off

The dishwasher is ready to be connected to your wireless network or paired with your smartphone/tablet.

Flashing 1.0 sec on/off

The dishwasher is connected to your wireless network.

Glow

The dishwasher is connected to your wireless network and the cloud.

Remote control the dishwasher

The dishwasher's network symbol  is shown on the display when the dishwasher is paired with a smartphone/tablet. You can use the *ConnectLife* app to monitor the dishwasher and change settings.

Remote start the dishwasher

To remote start the dishwasher, press . Remote start activated will appear on the dishwasher's display. Close the door. The status light will flash blue/green to indicate that remote start is activated.

In the *ConnectLife* app, select and start a program.



If the door is not closed within 2 minutes, the machine switches off.

NOTE!

The dishwasher can always be used without the app. When the dishwasher's control panel is pressed, commands from the *ConnectLife* app are blocked for 10 seconds.



Pair more devices

Pair more devices/users with the dishwasher. (This can also be done from the dishwasher's Settings menu.)

- In the ConnectLife application, go to the »Add devices« menu and select the appropriate type of device. Then scan the QR code (it can be found on the serial number plate of the appliance; you can also enter the AUID/SN number manually).
- Open the dishwasher door and press .
- On the dishwasher's control panel: Press and hold  for 4 seconds to initiate *Add device*.



WiFi connection Off / WiFi connection On

After connecting the dishwasher to your local network, you can select *WiFi connection Off* to deactivate the connection. Select *WiFi connection On* to reconnect to the same network. (This can also be done from the dishwasher's Settings menu.)

- On the dishwasher's control panel: Press and hold  for 8 seconds to select *WiFi connection Off*. Briefly press  to select *WiFi connection On* again.

Remove all devices



Remove all connected devices/users. (This can also be done from the dishwasher's Settings menu.)

- On the dishwasher's control panel: Press and hold  until *Add device* is shown on the display. Once a countdown has begun, press and hold  for 3 seconds. *Remove all devices* indicates that all devices/users have been erased.

Do you have questions? Please visit us at www.connectlife.io or contact us at hello@connectlife.io.

Settings

Open the door and press .

To open the dishwasher's Settings menu, press < or > until  Settings menu is shown on the display and confirm your selection with .

To exit the dishwasher's Settings menu, select Exit and confirm your selection with .







Settings	Alternatives
1. Language	You can choose the language used for the display.
2. Network	The current WiFi status is shown on the display.
WiFi status	Connect the dishwasher to your wireless network to be able to remote control the dishwasher using the <i>ConnectLife</i> app.
WiFi connection	<i>On/Off</i> After connecting the dishwasher to your local network, you can select <i>WiFi connection Off</i> to deactivate the connection. Select <i>WiFi connection On</i> to reconnect to the same network.
Connection setup	Connect the dishwasher to your wireless network and pair with your smartphone/tablet. <ul style="list-style-type: none"> In the <i>ConnectLife</i> application, go to the »Add devices« menu and select the appropriate type of device. Then scan the QR code (it can be found on the serial number plate of the appliance; you can also enter the AUID/SN number manually). Select <i>Connection setup</i>.
Add device	Pair more devices/users with the dishwasher. <ul style="list-style-type: none"> In the <i>ConnectLife</i> application, go to the »Add devices« menu and select the appropriate type of device. Then scan the QR code (it can be found on the serial number plate of the appliance; you can also enter the AUID/SN number manually). Select <i>Add device</i>.
Remove all devices	Select <i>Remove all devices</i> to remove all connected devices/users.
WiFi factory reset	Select <i>WiFi factory reset</i> to restore the default factory settings.
Exit	Select <i>Exit</i> to exit the menu for Network, press  .

Settings	Alternatives	
3. Select programs	Eco <i>On/Off</i> Auto <i>On/Off</i> Universal <i>On/Off</i> Intensive <i>On/Off</i> Quick pro <i>On/Off</i> Preheated <i>On/Off</i> Crystal glass <i>On/Off</i> Time program <i>On/Off</i> Hygiene <i>On/Off</i> Plastic <i>On/Off</i> Rinse and hold <i>On/Off</i> Self-cleaning <i>On/Off</i> Lower half <i>On/Off</i> Upper half <i>On/Off</i> Anti-odour <i>On/Off</i>	Programs can be shown or hidden in the menu. Choose between On and Off. (Eco cannot be hidden in the menu.)
4. Automatic child lock	<i>On/Off</i>	You can activate the Automatic child lock setting to prevent children from starting the dishwasher. To temporarily deactivate or activate the Automatic child lock setting, press and hold < and  for three seconds.
5. Display: Logotype	<i>On/Off</i>	Setting to hide the logo shown on the display.
6. Display: Brightness	<i>1/2/3/4</i>	For adjusting the brightness of the display.
7. Feedback volume	<i>0/1/2/3</i>	A beep confirms that the control panel has been pressed.
8. Notification volume	<i>0/1/2/3</i>	The buzzer indicates when a dishwashing program has ended. <i>Error messages are always indicated by a loud buzzer.</i>
9. Rinse aid	<i>0/1/2/3/4/5</i>	Setting for rinse aid dosage. The rinse aid dispenser can be adjusted between 0 (Off) and 5 (High dosage). Increase the rinse aid dosage: <ul style="list-style-type: none"> • If the dishes have water marks. Decrease the rinse aid dosage: <ul style="list-style-type: none"> • If the dishes have a sticky white/blue film. • If the dishes are streaked. • Build-up of foam. If you have very soft water, the rinse aid can be diluted 50:50 with water.

Settings

Settings	Alternatives	
10. Water hardness	<i>0/1/2/3/4/5/6/7/8/9</i>	<p>Adjusting the water softener. Select a setting depending on the hardness of the water supply. It is important that this setting is correct!</p> <p>See <i>Water hardness</i> in the chapter <i>Before washing for the first time</i>.</p> <p>For a water supply with a hardness above 5 °dH (9 °fH / 6 °eH / 0.9 mmol/l), fill with salt. For a water supply with a hardness below 6°dH (10°fH / 7°eH / 1.0 mmol/l), select 0. The water softener is deactivated and no salt needs to be added.</p>
11. TAB (All-in-one detergent)	<i>On/Off</i>	<p>Activate the setting when using all-in-one detergent containing rinse aid. (Also applies to dishwasher detergent gel for automatic dosing that contains rinse aid.)</p> <p>This setting reduces the rinse aid dosage and affects how often the dishwasher's built-in softener is regenerated.</p>
12. Auto dose	<i>Off, 15-40 ml</i>	<p>Activate this setting if you want to use automatic dosing of detergent.</p> <p><i>The exact dosage depends on which program is running. For the Auto program, the dosage also depends on how dirty the dishes are.</i></p>
13. Super rinse	<i>On/Off</i>	<p>The Super rinse function rinses the dishes an extra two times.</p> <p>The program time is extended and the dishwasher uses more energy and water.</p> <p><i>Activated in the following programs:</i></p> <ul style="list-style-type: none"> <i>Universal</i> <i>Intensive</i> <i>Quick pro</i> <i>Hygiene</i> <i>Plastic</i> <i>Lower half</i> <i>Upper half</i>
14. Push to open	<i>On/Off</i>	<p>The dishwasher door can be opened without a handle.</p>
15. Interior light at power off	<i>On/Off</i>	<p>Select whether the interior light is to be switched on when the dishwasher is turned off and the door is opened. (If  is turned on, the interior light is always switched on when the door is opened.)</p>

Settings	Alternatives	
16. Odour control	<i>On/Off</i>	When Odour control is activated,  Anti-odour can be selected from the program table.
17. Failure readout		Any error messages. <i>When contacting your service centre, you may be asked to provide the most recent error messages.</i>
18. Factory reset		Restores all settings to the factory defaults. Select Factory reset and press   .
19. Exit		To exit the dishwasher's Settings menu, select Exit and press  .

Care and cleaning

✳ Top up rinse aid

When the rinse aid needs topping up, the symbol lights on the display.

See the chapter *Before washing for the first time*.

Ⓢ Top up salt

When the salt needs topping up, the symbol lights on the display.

See the chapter *Before washing for the first time*.

💧 Top up auto dose

When the dishwasher detergent gel needs topping up, the symbol appears on the display. (You can run 1-2 wash programs before the compartment is completely empty.)

See the chapter *Before washing for the first time*.

Clean the automatic dosing compartment

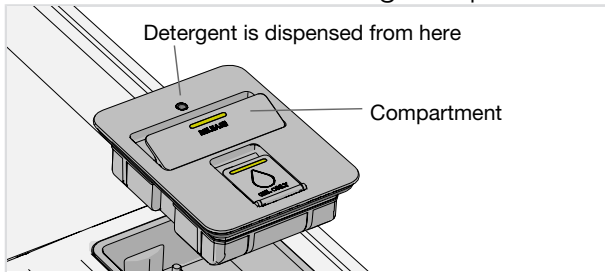

1. The compartment can be lifted out for cleaning and refilling.
2. Check that the dispensing hole is not blocked. Clean the compartment with hot water.

NOTE!

Important - refit the compartment. The dishwasher must not be used without the automatic dosing compartment in place!

Clean the filters

Coarse filter

The coarse filter traps larger food particles, which cannot get past the drainage pump. Empty the coarse filter when necessary. It should be cleaned at regular intervals depending on how often the dishwasher is used.

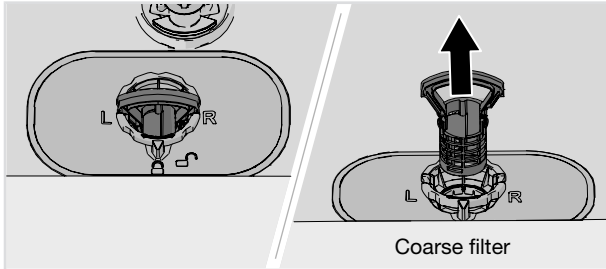

1. Lift the coarse filter by the handle.
2. Empty the coarse filter.
3. Refit the coarse filter. Press it down until it clicks into place.

Fine filter

Debris that collects on the fine filter is automatically rinsed away during each wash. Clean the fine filter when necessary. It should be cleaned at regular intervals depending on how often the dishwasher is used.

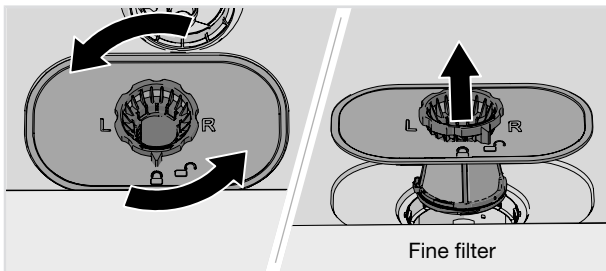

1. Turn the locking ring anticlockwise and lift the fine filter straight up.
2. Clean the fine filter.
3. Refit the fine filter and turn the locking ring clockwise to its stop position. Check that the edges seal properly.

Remember to refit the coarse filter!

Care and cleaning

NOTE!

Dishwashing results may be affected if the coarse and fine filters are incorrectly fitted. The dishwasher must not be used without the filters in place!

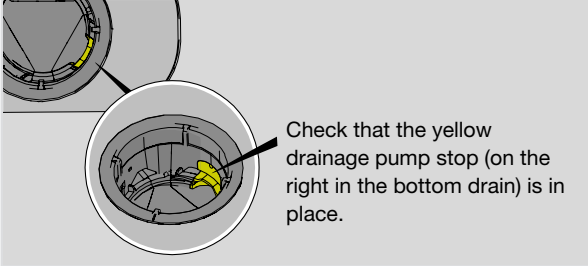

Cleaning the spray arms and spray pipes

Holes and bearings can sometimes become blocked. Remove any debris using a pin or the like. The spray arms also have holes underneath.

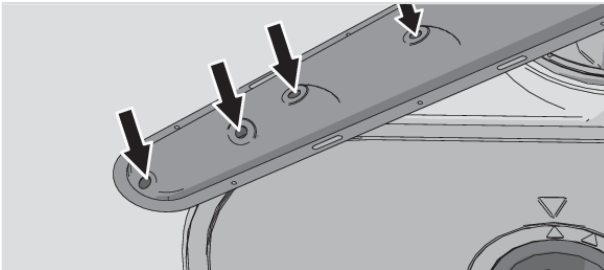

To facilitate cleaning you can remove the spray arms. Remember to fit them firmly back into place afterwards.

Top spray arm

- Pull out the top cutlery tray. Push up on the top spray arm while turning it anticlockwise to release it.

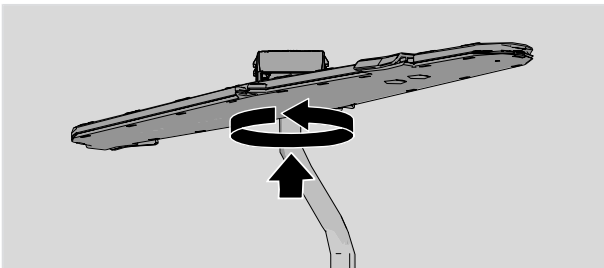

Upper spray arm

- Pull out the upper basket.
- Unscrew the spray arm bearings anticlockwise to remove the spray arm from the upper basket.

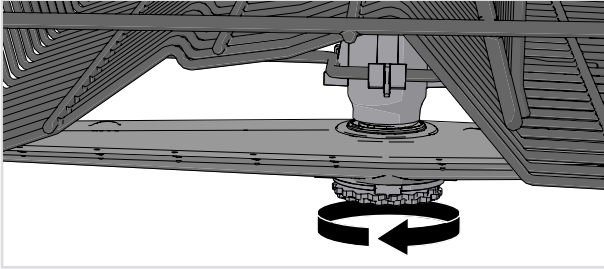

The middle basket's spray pipes

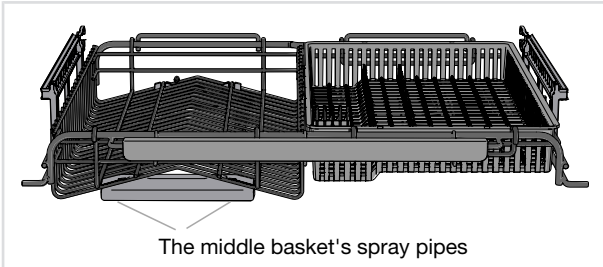

- Pull out the middle basket.
- Check the holes in the spray pipes.

Lower spray arm

- Pull the lower spray arm straight up to release it.

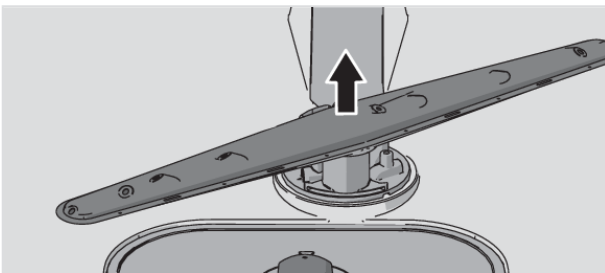

Clean the outside of the dishwasher

Door and door seal

Open the door. Clean the sides of the door and the door seal regularly with a slightly damp cloth. Clean the door seal at the lower front edge of the dishwasher with a washing-up brush.

Care and cleaning

Control panel

Keep the control panel clean. If necessary, wipe it with a dry or slightly damp cloth. Never use cleaning products – they may scratch the surface.

Run Self-cleaning

Dishwasher tub

The dishwasher tub is made of stainless steel and is kept clean through normal use (when used regularly).

If you have hard water, limescale deposits may build up in the dishwasher. If this happens, run the Self-cleaning program with two tablespoons of citric acid in the dishwasher's manual detergent compartment (with no dishes in the machine). Special dishwasher cleaners are also available on the market.

Remove blockages

Unblocking the drainage pump

If the dishwasher still contains water after the program has finished, something may be blocking the drainage pump, which results in the error message Water outlet fault or BLDC drain pump fault.

1. Turn off the machine using  and remove the plug from the wall socket.
2. Remove the coarse filter and the fine filter.
3. Scoop out the water from the dishwasher tub.
4. In order to inspect the drainage pump, remove the yellow drainage pump stop on the right in the bottom drain. (Use a pair of pliers if necessary.)
5. Turn the pump wheel located behind the drainage pump stop by hand. Carefully remove any sharp items, such as glass.
6. Refit the drainage pump stop along with the fine and coarse filters.
7. Plug the machine in again.

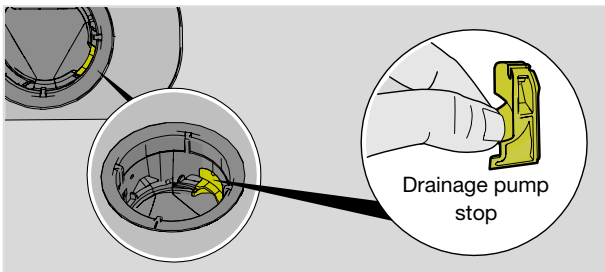

NOTE!

Do not forget to refit the drainage pump stop.

Unblocking the inlet hose filter

If the water supply contains small particles, the outer filter on the inlet hose may become blocked, which results in the Water inlet fault error message.

1. Turn off the machine using  and remove the plug from the wall socket.

2. Turn off the water tap.
3. Unscrew the inlet hose.
4. Carefully remove the outer filter from the inlet hose and clean it.
5. Refit the filter and check that the gasket is correctly positioned.
6. Screw the inlet hose firmly into place.
7. Plug the machine into the wall socket and turn on the water tap. Allow the pressure to settle for a while and check that the connection is watertight.

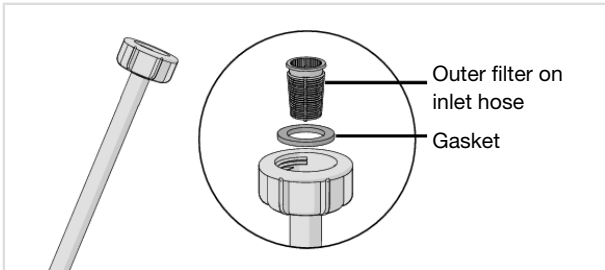

Winter storage/Transport

Store the dishwasher above freezing temperature and avoid long transport distances in very cold weather. Transport the dishwasher upright or laying on its back.

Handle the front corners of the dishwasher with care so that they do not get bent, which can affect door opening.

Before transporting a used dishwasher, or before prolonged storage, water must first be removed from the machine. Run the Self-cleaning program.

Troubleshooting

Error messages		Action
F10	Overfilling water 1	Unblocking the drainage pump. See the chapter <i>Care and cleaning</i> . If the problem persists, contact your nearest service centre.
F11	Water outlet fault	See "Water remains in the dishwasher" under "Problem" in the table below. If the problem persists, contact your nearest service centre.
F12	Water inlet fault 1	Check that the water tap is on. Check that the outer filter on the inlet hose is not blocked. See <i>Unblocking the inlet hose filter</i> in the chapter <i>Care and cleaning</i> . If the problem persists, contact your nearest service centre.
F40	Inlet valve leakage	Turn off the water tap and contact your nearest service centre.
F41	Heater fault 1	Turn off the water tap. Remove the plug from the wall socket and contact your nearest service centre.
F45	Diverter fault	Contact your nearest service centre.
F52	Water level fault	Clean the coarse and fine filters. Check that the outer filter on the inlet hose is not blocked. If the problem persists, contact your nearest service centre.
F54	Overfilling water 2	Turn off the water tap and contact your nearest service centre. To avoid water leakage outside the dishwasher, do not remove the plug from the wall socket until the water tap on the supply line has been turned off!
F56	Circulation pump fault	Contact your nearest service centre.
F67	Water inlet fault 2	Check that the water tap is on. Check that the outer filter on the inlet hose is not blocked. See <i>Unblocking the inlet hose filter</i> in the chapter <i>Care and cleaning</i> . If the problem persists, contact your nearest service centre.
F68	BLDC drain pump fault	See "Water remains in the dishwasher" under "Problem" in the table below. If the problem persists, contact your nearest service centre.



Press any button to clear the error message.

General

Problem	Possible causes	Action
The control panel does not react when pressed.	You have pressed the control panel too soon after opening the door.	Wait a moment then try again.
	Child lock or Automatic child lock is activated.	See the chapter <i>Safety instructions</i> .
	The door is closed.	Open the door. The control panel only reacts to use when the door is open.
	Dirt on the control panel.	Clean with a dry or slightly damp cloth.
	The control panel requires calibration.	Turn off the water tap. Remove the plug from the wall socket and wait for 60 seconds. Then plug the appliance back into the wall socket and turn on the water tap.
Cannot close door.	The baskets are not correctly positioned.	Check that the baskets are correctly positioned horizontally, and that the middle basket's water connector is in line with its spray pipe.
		Check that the dishes are not blocking the baskets from sliding properly into place.
	The door lock does not click into place and lock.	<p>Check the door lock. If it does not click into place and lock, open the door.</p> <p>Press and hold < and  until the display starts flashing. Wait until it stops flashing (60 seconds). Close the door.</p> <p>Check that the door lock clicks into place and locks.</p>

Troubleshooting

Problem	Possible causes	Action
The dishwasher does not start.	▶ □ has not been pressed.	Press ▶ □ until the display shows "Program started, close door".
	The door is not properly closed.	Check.
	You have opened the dishwasher to add more dishes while a program is in progress.	Close the door and wait. After a while, the dishwasher continues the program.
	The door lock has not clicked into place and locked.	Check the door lock. If it has not clicked into place and locked, open the door. Press and hold < and ↻ until the display starts flashing. Wait until it stops flashing (60 seconds). Close the door. Check that the door lock clicks into place and locks.
	Check whether the Delayed start option has been selected.	Press and hold ▶ □ for three seconds if you want to cancel the Delayed start option.
	The plug is not plugged into the wall socket.	Check.
	A fuse/circuit breaker has been tripped.	Check.

Problem	Possible causes	Action
The dishes are not clean.	The spray arms do not rotate.	Check that the dishes are not blocking the spray arms.
	Spray arm holes or bearings blocked.	Clean the spray arms and the middle basket's spray pipes. See the chapter <i>Care and cleaning</i> .
	Unsuitable dishwashing program.	Select a program with Intensive. The program will use a higher temperature to dissolve grease on very dirty dishes.
	Incorrect detergent dosage.	Dose according to water hardness. Far too much or far too little detergent results in poorer dishwashing results.
	Old detergent. Detergent is a perishable product.	Avoid large packages.
	Auto dose is activated, but dishwasher detergent gel is not dispensed.	To check that detergent is dispensed, press and hold  and  for five seconds. The symbol  will flash on the display and the status light will turn red. Now check whether any dishwasher detergent gel has been dispensed.
	Dishes loaded incorrectly.	Do not cover porcelain with large bowls or the like. Avoid placing very tall glasses in the corners of the baskets. See the chapter <i>Loading the dishwasher</i> .
	Glasses and cups have toppled over during the program.	Place dishes to sit steady.
	The filters are clogged.	Clean the coarse and fine filters.
	The filters are not fitted correctly.	Check that the filters are fitted correctly. See the chapter <i>Care and cleaning</i> .
Drainage pump stop missing.	Check that the yellow drainage pump stop (on the right in the bottom drain) is in place. See the chapter <i>Care and cleaning</i> .	

Troubleshooting

Problem	Possible causes	Action
Spots on stainless steel or silver.	Some foodstuffs, such as mustard, mayonnaise, lemon, vinegar, salt and dressings, can cause spots on stainless steel if left for too long.	Rinse off these types of foodstuffs if not starting the dishwasher immediately. Use the Rinse and hold program.
	All stainless steel can cause spots on silver if they come into contact during dishwashing. Aluminium can also cause spots on dishes.	In order to avoid marks and tarnishing, separate dishes made from different metals, such as silver, stainless steel and aluminium.
Spots or films on the dishes.	Incorrect rinse aid dosage setting.	See the chapter <i>Settings</i> .
	The setting TAB is activated and all-in-one detergent with insufficient drying effect is being used.	Switch all-in-one detergents or deactivate the setting TAB and top up with salt and separate rinse aid. See Rinse aid in the chapter <i>Settings</i> .
	Salt compartment empty.	Top up with salt. See the chapter <i>Care and cleaning</i> .
	Incorrect water softener setting.	See Water hardness in the chapter <i>Settings</i> .
	The water softener is leaking salt.	Check that the salt compartment lid is properly tightened. Otherwise contact your nearest service centre.
	Too high temperature and/or too much detergent can cause etching on crystal. Unfortunately, this cannot be repaired, only prevented.	Wash crystal at a low temperature and with a conservative amount of detergent. Contact the detergent manufacturer.
The dishes have a sticky white/blue film.	Rinse aid dosage setting too high.	Reduce the dosage. See the chapter <i>Settings</i> . If you have very soft water, you may want to dilute the rinse aid 50:50 with water.

Problem	Possible causes	Action
Spots left after washing.	Lipstick and tea/coffee stains can be difficult to remove.	Use a detergent with a bleaching agent. Dishwasher detergent gel is being used. If necessary, on such occasions dishwasher detergent powder or all-in-one detergent with bleaching agent can be added to the manual detergent compartment (when Auto dose is activated). See <i>Add detergent</i> .
Detergent residue in the detergent compartment after dishwashing.	The detergent compartment was damp when adding detergent.	The detergent compartment must be dry when adding detergent.
	The detergent compartment has been blocked.	Check that the dishes are not preventing the detergent compartment from opening.
Rattling sound when dishwashing.	The dishes are not correctly placed or the spray arms are not rotating.	Check that the dishes are placed securely. Spin the spray arms to make sure they can rotate.
Water remains in the dishwasher.	The filters are clogged.	Clean the coarse and fine filters.
	The filters are not fitted correctly.	Check that the filters are fitted correctly. See the chapter <i>Care and cleaning</i> .
	Debris in the drainage pump.	Clean the drainage pump. See the chapter <i>Care and cleaning</i> .
	Drainage pump stop missing.	Check that the yellow drainage pump stop (on the right in the bottom drain) is in place. See the chapter <i>Care and cleaning</i> .
	Kink in drainage hose.	Check that the hose is free from kinks and sharp bends.
	Blocked drainage hose.	Disconnect the drainage hose where it connects to the sink unit's water trap. Check that no debris has fastened and that the connection has an inner diameter of at least 14 mm.

Troubleshooting

Problem	Possible causes	Action
Bad odour in dishwasher.	Dirt around the seals and in corners.	Clean with washing-up brush and low foaming cleaner.
	Low temperature programs have been selected for a prolonged period.	Run a program with a high temperature once or twice a month. Or run a self-cleaning program. See Self-cleaning in the chapter <i>Using the dishwasher</i> .
Grease deposits in the dishwasher.	Low temperature programs have been selected for a prolonged period.	Select a program with Intensive. The program will use a higher temperature to dissolve grease on very dirty dishes. Or run a self-cleaning program once or twice a month. See Self-cleaning in the chapter <i>Using the dishwasher</i> .
The dishes are not dry enough.	The Automatic door opening option is not activated.	Activate the Automatic door opening option.
	The dishwasher is not fully loaded.	Fully load the dishwasher.
	Rinse aid needs topping up or dosage is set too low.	Top up with rinse aid or increase the rinse aid dosage setting.
	The setting TAB is activated and all-in-one detergent with insufficient drying effect is being used.	Switch all-in-one detergents or deactivate the setting TAB and top up with salt and separate rinse aid. See Rinse aid in the chapter <i>Settings</i> .

WiFi

Problem	Possible causes	Action
The dishwasher's network symbol  does not appear on the display.	The dishwasher is not connected to your wireless network.	Connect the dishwasher to your wireless network. See the chapter <i>ConnectLife</i> .
	WiFi connection is deactivated.	Activate WiFi connection. See <i>WiFi connection Off / WiFi connection On</i> in the chapter <i>ConnectLife</i> .
Connection setup failed	The dishwasher cannot access your wireless network. Or the router is not connected to the internet.	Check that the router is connected to the internet.
		Make sure your wireless network is using 2.4 GHz and is visible. Try moving the router closer to the dishwasher if the signal is too weak.
		See also troubleshooting at www.connectlife.io . If the problem persists, contact your nearest service centre.
Add device failed	Your smartphone/tablet is not connected to your wireless network. Or the router is not connected to the internet.	Check that the router is connected to the internet.
		Check that your smartphone/tablet is connected to your wireless network.
		See also troubleshooting at www.connectlife.io . If the problem persists, contact your nearest service centre.
The dishwasher is shown as disconnected in the <i>ConnectLife</i> app.	WiFi connection is deactivated.	Activate WiFi connection. See <i>WiFi connection Off / WiFi connection On</i> in the chapter <i>ConnectLife</i> .
		See also troubleshooting at www.connectlife.io . If the problem persists, contact your nearest service centre.
Software update failed.	The network connection was lost or the dishwasher lost power due to a power failure.	Make sure that the power supply is not interrupted and that the network connection is stable before trying again. If the problem persists, contact your nearest service centre.

Installation

It is important that you read through and follow the instructions and directions below. Conduct installation and connection in accordance with the separate installation instructions.

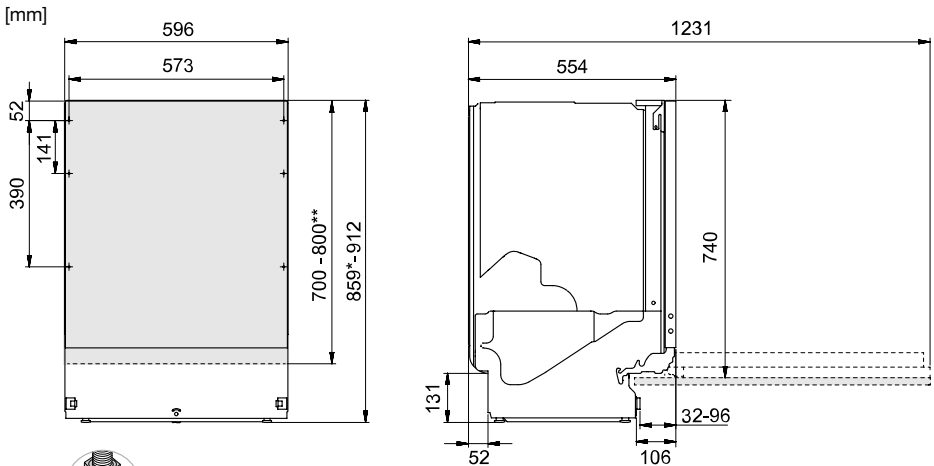

*Remove the locking nuts when installing in a recess measuring 860-861 mm.

**Cover door length.

Nominal dimensions. Actual measurements may vary.

Safety instructions

- Connections to electricity, water and drainage must be performed by a qualified professional.
- Always follow applicable regulations for water, drainage and electricity.
- Take care during installation! Wear protective gloves! There must always be two people!
- Place a drip tray on the floor beneath the dishwasher to prevent damage from any water leaks.
- Before screwing the dishwasher into place, test the dishwasher by running the Rinse and hold program. Check that the dishwasher fills with water and drains. Check also that none of the connections leak.

WARNING!

The ventilation opening in the lower part of the door must not be blocked by a rug, carpet or similar furnishing.

WARNING!

Turn off the water supply when installing the dishwasher!

The plug must be disconnected or power to the socket turned off while the work is carried out!

Setup

- The recess and connection dimensions are included in the separate installation instructions. Check that all dimensions are correct before starting the installation. Note that the height of the cover door can be adjusted to match other fittings.
- Handle the front corners of the dishwasher with care so that they do not get bent, which can affect door opening.
- Make sure the area on which the dishwasher is to be installed is firm. Adjust the adjustable feet so that the dishwasher is level. Tighten the lock nuts.
- If the dishwasher is built-in the surrounding furnishings must be resistant to any condensation from the dishwasher.
- Mount the protective film beneath the worktop and up around the edge. The function of the protective film is to protect the worktop from moisture. (The protective film is in the enclosed plastic bag.)
- Check that the machine is installed such that the door opens freely, otherwise door lock functionality may be disrupted.
- Note that the door springs may need adjusting after a cover door has been fitted. Adjust the left and right door springs equally until the door is evenly balanced.

Drainage connection

This dishwasher is suitable for installing in a raised recess (to attain an ergonomic working height). This means that the dishwasher can be placed so that the drainage hose runs to a lower level than the bottom of the dishwasher, such as by routing it directly to a floor drain.

The drainage hose can also be connected to a connection nipple on the sink unit's water trap. The connection nipple must have an internal diameter of at least 14 mm.

The drainage hose may be extended by a maximum of 2.5 m (the total length of the drainage hose must not exceed 4.5 m). Any joints and connecting pipes must have an internal diameter of at least 14 mm.

No part of the drainage hose may be more than 950 mm above the bottom of the dishwasher.

Attach the drainage hose with a hose clamp. Ensure that the drainage hose has no kinks.

Connection to water supply

Use only the inlet hose supplied with the dishwasher. Do not re-use old or other spare hoses.

The supply pipe must be fitted with a water tap (stopcock). The water tap must be easily accessible, so that the water can be shut off if the dishwasher has to be moved.

Once the installation is complete, turn on the water tap and allow the pressure to settle for a while. Check that all connections are watertight.

Connect to cold water

Connect the dishwasher to the cold water supply if the building is heated using oil, electricity or gas.

Connect to hot water

Connect the dishwasher to the hot water supply (max. 70 °C) if the building is heated using an energy-efficient means such as district heating, solar power or geothermal power. Choosing a hot water connection reduces the dishwasher's energy consumption.

Installation

NOTE!

Do not exceed the permitted water supply temperature. Certain materials used in some cookware cannot withstand high heat. See *Fragile dishes* in the chapter *Loading the dishwasher*.

Electrical connection

Information about the electrical connection can be found on the serial number plate. This specification must match the electricity supply.

The dishwasher must be connected to an earthed socket.

The electric wall socket must be placed outside of the installation area to be easily accessible after installing the dishwasher. Do not use an extension cord!

Push to open

The dishwasher door can be opened without a handle.

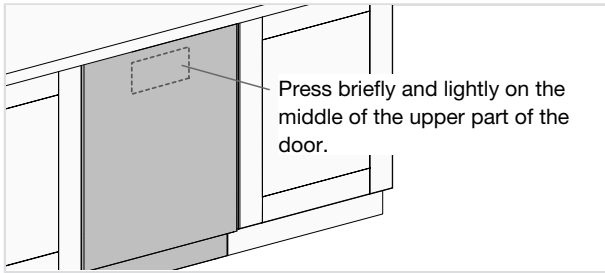

NOTE!

The door can be opened manually if the dishwasher is not connected to the electrical supply. Grasp the door on both sides at the top and pull it straight out.

Information about your product

There is a QR code on the serial number plate. Scan the code to view information about your product.

Contact your nearest service centre

Read the chapter *Troubleshooting* before contacting the service centre. If you have encountered a problem that you cannot resolve, please contact your nearest service centre for professional help, see www.asko.com. Our website also has information about spare part availability and what you can repair yourself.

When making contact, provide the details on the serial number plate. Include the article number (1) and the serial number (2).

Please note that non-professional repairs may risk user safety and affect the warranty.

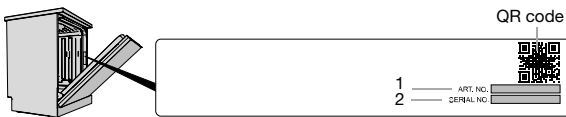

Number of cycles

Press and hold > and ≡ for 3 seconds to show Number of cycles on the display.

Technical data and energy labelling

Technical data

Height:	859-912 mm
Width:	596 mm
Depth:	554 mm
Weight:	55 kg ¹⁾
Number of standard place settings:	17 ²⁾
Water pressure:	0.03-1.0 MPa
Electrical connection:	See the serial number plate
Rated power:	See the serial number plate

¹⁾ Weight can vary due to different specifications.

²⁾ In accordance with the EN 60436 standard.

Information for consumers

Information about your appliance can be found at <https://global.asko.com/energy-label>. You can also find information in the EU Product Registration database for Energy Labelling, EPREL. Scan the QR code on the energy label supplied with the dishwasher (or go to <https://eprel.ec.europa.eu> and search for the model name).

This appliance contains a light source/light sources of energy efficiency class D. Light sources are available as spare parts and can be replaced, without damage to the dishwasher, by your nearest service centre or a similarly qualified professional.

Information for test institute

Information about this product can be found in the European Product Database for Energy Labelling, EPREL, and can also be ordered by e-mail dishwashers@appliance-development.com.

The request should include the details on the serial number plate. Include the article number (1), the serial number (2) and the model name (3).



Declaration of conformity

We hereby declare that this appliance is in conformity with the relevant European directives and the requirements of the relevant standards.

ASKO

Inspired by Scandinavia

WWW.ASKO.COM



865411-a10

We reserve the right to make changes.