

# Hisense

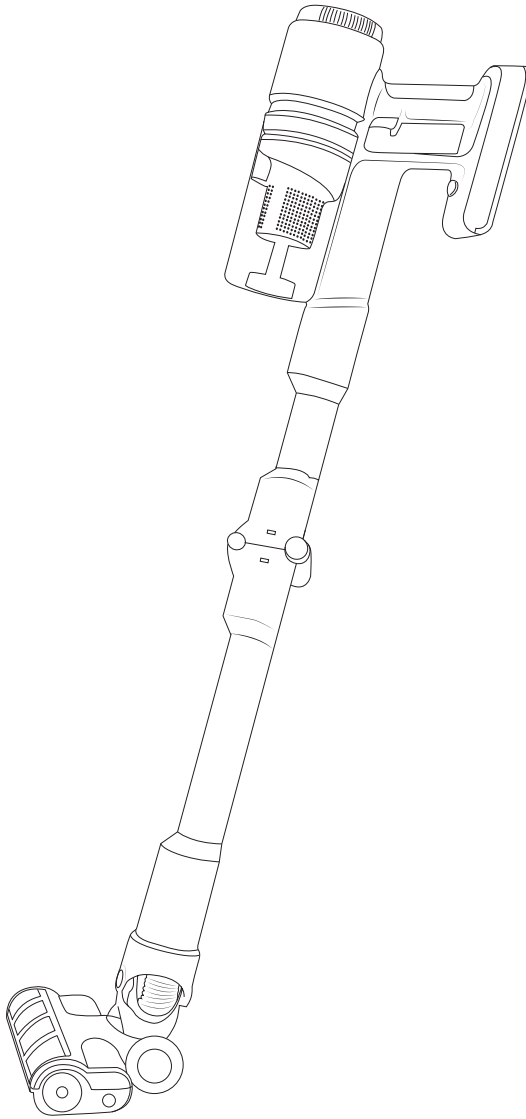

CORDLESS  
VACUUM  
CLEANER  
HI-MOVE IV  
HVC6264xx

QUICK GUIDE



---

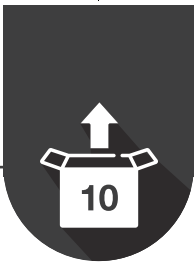

1. Motor unit with housing, battery and dust container

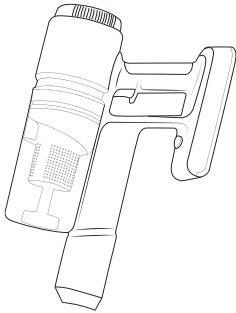

2. Foldable tube

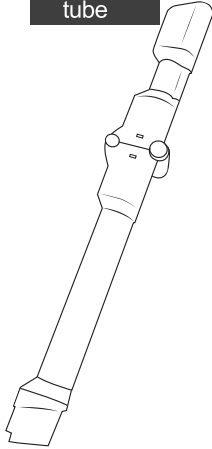

3. Flexible tube



4. Motorized electric brush

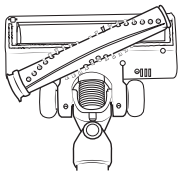

5. Crevice nozzle

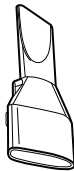

6. Dusting brush



7. Bed nozzle

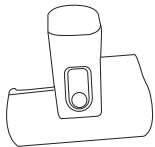

8. Wall-mounted base with adapter and power cord

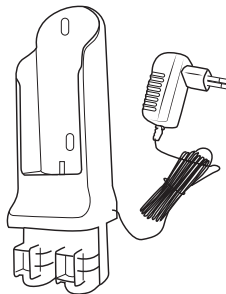

9. 2 x screws

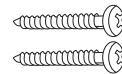

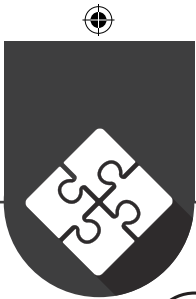

1.

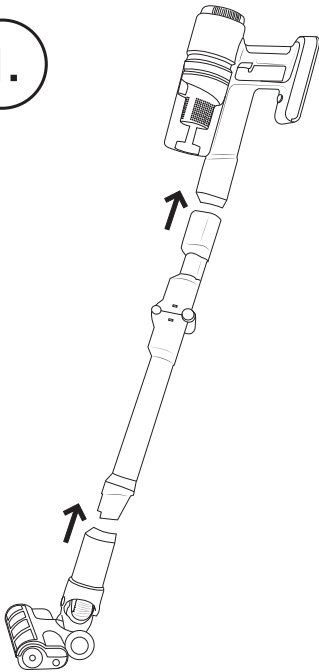

2.

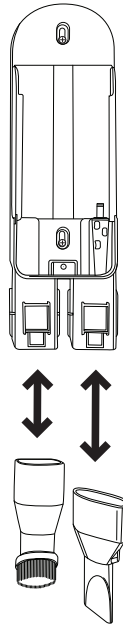

3.

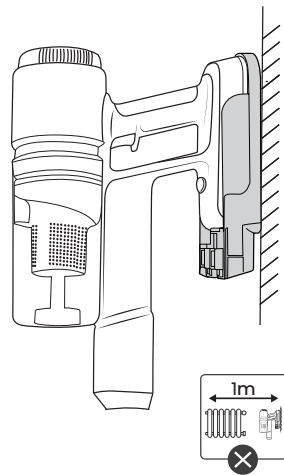
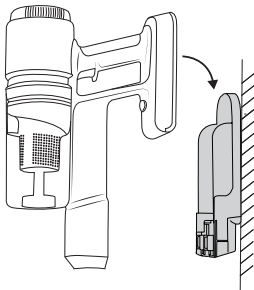
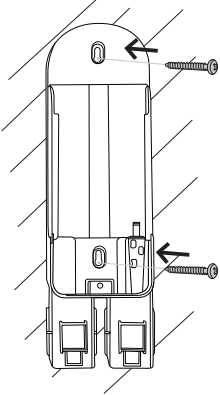





---

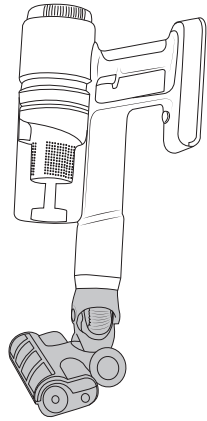
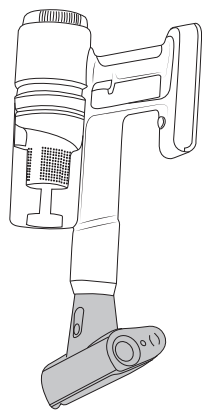
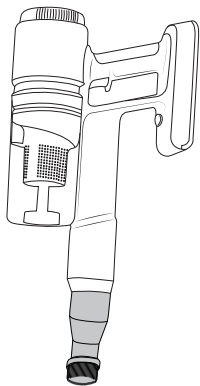
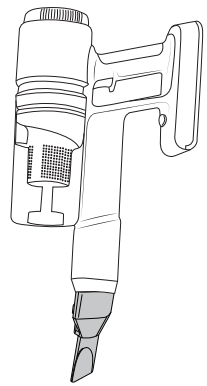

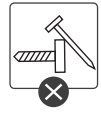
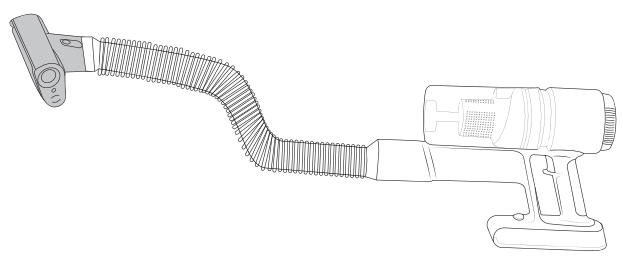
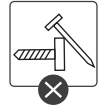
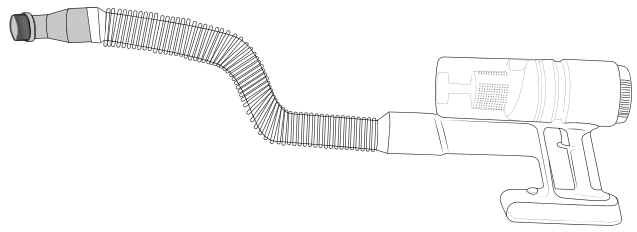
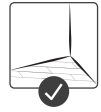
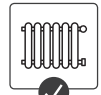
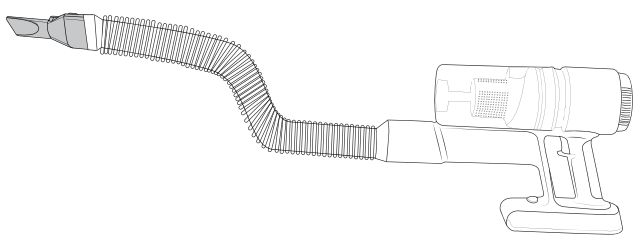



**a**

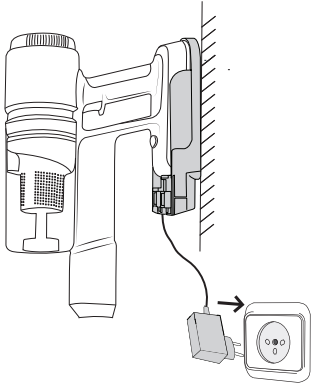

**b**

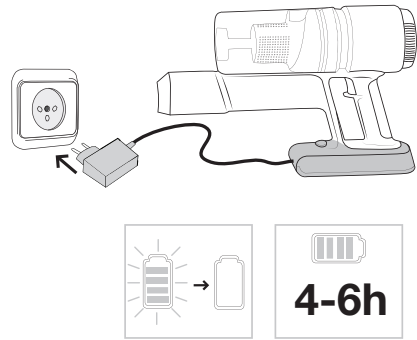

**c**

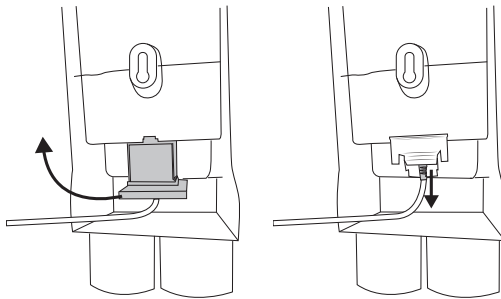
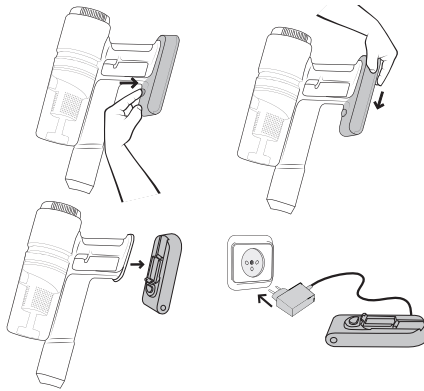



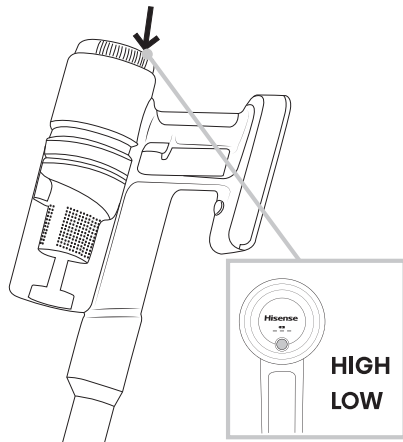
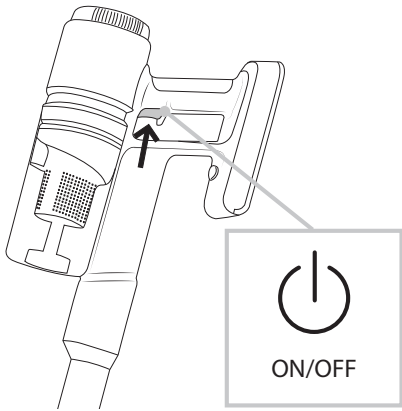
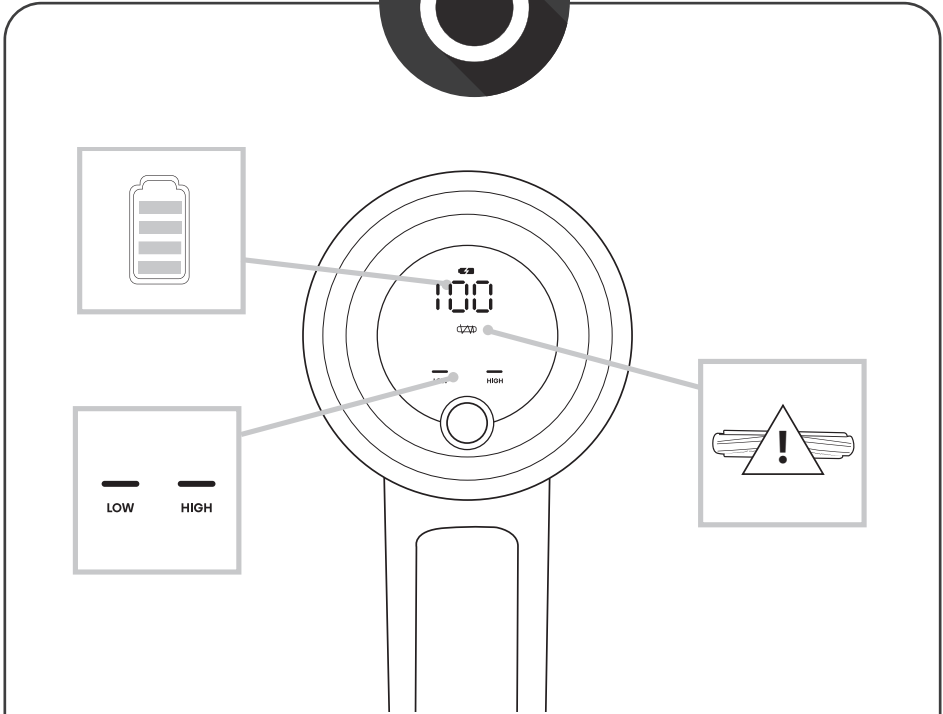

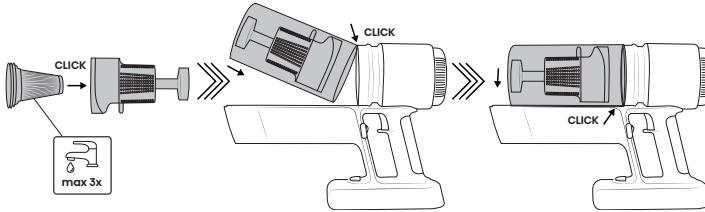
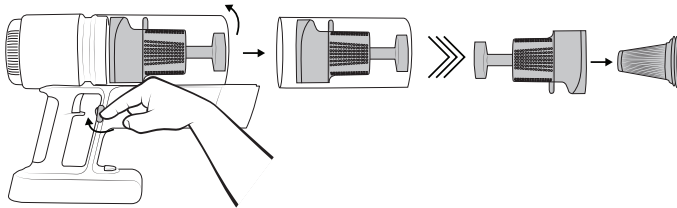
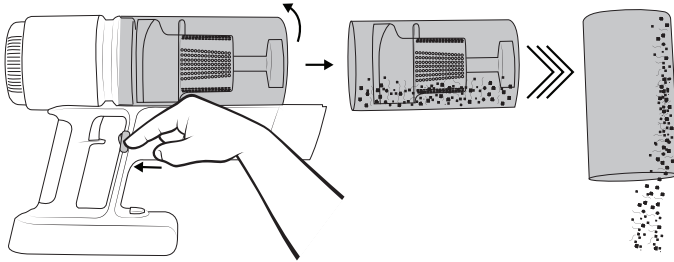

## Filter quick clean

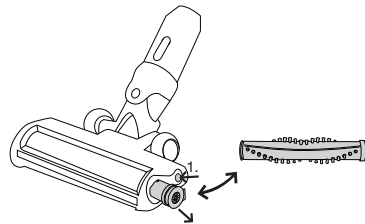
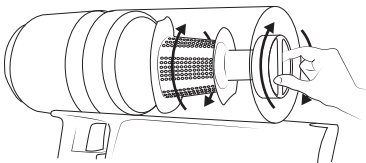

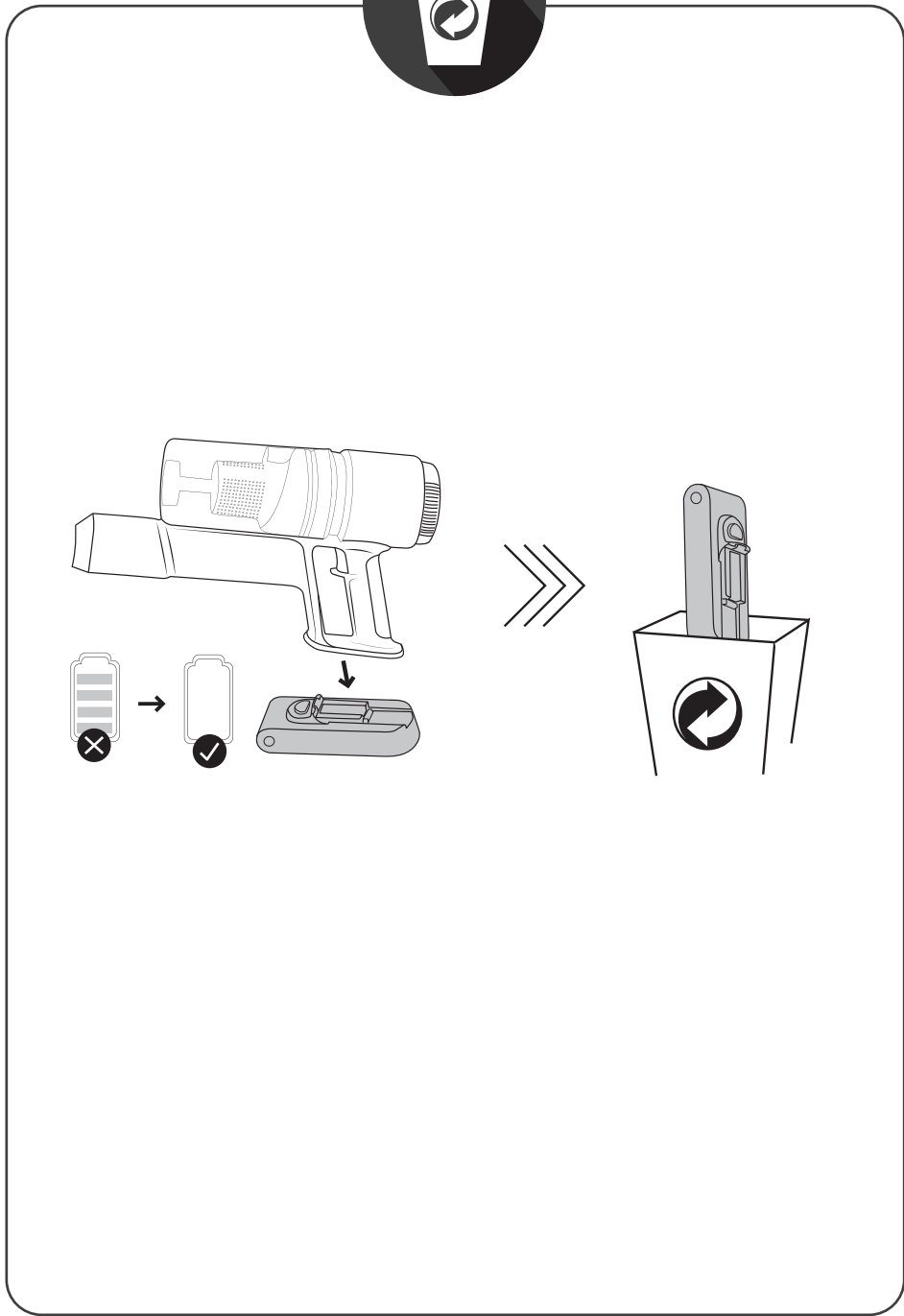

**Hisense**