

Dear Customer,

Thank you for choosing this quality product from ASKO.

We hope it will meet your expectations and fulfil your needs for many years to come.

Scandinavian design combines clean lines, everyday functionality and high quality. These are key characteristics of all our products and the reason they are greatly appreciated throughout the world.

To get the most out of your new machine, we recommend that you read the operating instructions before using the machine. The operating instructions also include information on how you can help protect the environment.



Operating Instructions

Washing Machine
PROFESSIONAL WMC947VS

WARNING: Read the instructions before using the machine.

CONTENTS

SAFETY INSTRUCTIONS	3	TROUBLESHOOTING	13
Child safety	4	The washer door will not open	13
Installation	5	Opening the door in an emergency	13
Overflow guard function	5	The machine will not start	13
Transport/winter storage	5	After power failure	13
Packing material	5	Wet washing still in the machine	13
Recycling	5	Error messages	14
ADVICE AND TIPS BEFORE WASHING	6	TECHNICAL INFORMATION	15
Sorting your laundry	6	Information on energy labelling	15
Clothing	6	Information for test institute	16
Laundry labels	6	Technical data	16
Hot water connection	6	INSTALLATION	17
Coloured cotton	6	Positioning the washing machine	17
Unbleached linen	6	Adjusting the feet	17
Wool	6	Connection to water supply	17
Rayon fibres and synthetic fibres	6	INSTALLATION	18
Detergents	6	Drainage connection	18
USING YOUR WASHING MACHINE	7	BEFORE CONTACTING THE SERVICE DIVISION	19
Add detergent and fabric softener	7	Before contacting the service division	19
Programme selection	8	PROGRAMME CHART	20
Close the door and press the start button	9	QUICK GUIDE	24
During the programme	9		
SETTINGS	10		
Water intake	10		
CARE AND CLEANING	11		
Cleaning the detergent compartment	11		
Cleaning the outside of the machine	11		
Cleaning the inside of the machine to avoid unpleasant smells	11		
Rinse holes under the agitator	11		
If you have hard water	12		



SAFETY INSTRUCTIONS

GENERAL

- Keep the operating instructions in a safe place.
- The machine should only be used for washing items as described in these instructions. It is not intended for dry cleaning.
- Use only detergent intended for machine washing!
- Do not use detergents that contain solvents as this could lead to release of poisonous gases, damage to the machine, and risk of fire and explosion.
- Do not use colourants (dyes) or bleaching substances (substances for discolouration or removal of colourants) as they contain sulphuric compounds that could cause corrosion.
- Excessive use of products containing chlorine compounds increases the risk of premature failure of appliance components. This depends on the concentration of chlorine, exposure time, and temperature.
- Bleaches that contain chlorine can be replaced with oxygen-based bleaches. Otherwise, a neutralization cycle should be performed by running the Cotton program at the highest temperature. For best results, use hydrogen peroxide or oxygen-based detergents.
- Repairs and maintenance relating to safety or performance must be carried out by a qualified professional.
- Disconnect power to the machine before repair and service.
- Damaged mains cables must only be replaced by a qualified electrician.
- This machine can be used by children aged 8 and upwards, and by people with reduced physical capacity, mental ability, memory loss or lacking experience and knowledge. These individuals must be supervised when using the machine or have instructions on how to use the machine and understand the risks that can occur.
- Cleaning and maintenance of the machine must not be performed by children without supervision.



SAFETY INSTRUCTIONS

CHILD SAFETY

- Children must be watched to ensure they do not play with the machine.
- Always close the washer door and start the programme immediately after you have added detergent.
- Do not allow small children to use or play with the washing machine.
- Store detergent and fabric softener out of the reach of children.

Activate Child-safe start (button lock)

You can activate the Child-safe start option (button lock) to prevent children from starting the washing machine (see the Settings section).

Activate child safety catch (for detergent compartment)

On the inside of the detergent compartment is a child safety catch.

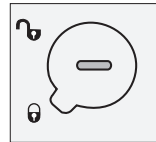

Activated child safety catch

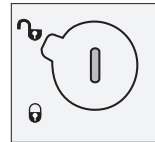

Inactivated child safety catch

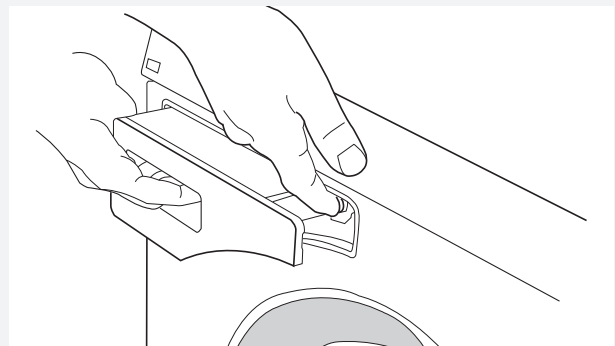

When the child safety catch is activated you must press the release button to pull out the detergent compartment.



SAFETY INSTRUCTIONS

INSTALLATION

- Conduct installation and connection in accordance with the separate installation instructions.
- Installation of water and electricity, if required, must be carried out by a qualified professional.
- Remove any transport protection devices before using the machine, see the separate installation instructions.

OVERFLOW GUARD FUNCTION

If the water level in the machine rises above normal, the overflow guard function begins to pump water out and shuts off the water intake. If the water level has not dropped within 60 seconds, the programme is terminated.

TRANSPORT/WINTER STORAGE

If the machine is to be transported or stored in unheated premises where the temperature can fall below freezing, do as follows:

- Shut off the water to the washing machine, loosen the supply hose to the intake valve and let the water run out from the valve and hose.

PACKING MATERIAL

Please sort waste materials in accordance with local guidelines.

RECYCLING

This machine is manufactured and labelled for recycling. In order to prevent injuries, the machine must be made unusable once the decision has been taken to dispose of it. Contact your local authority for information about where and how your machine should be correctly recycled.

ADVICE AND TIPS BEFORE WASHING

Here are some tips that may help you before washing.

SORTING YOUR LAUNDRY

Sort items according to:

- how soiled they are
- colour
- material

CLOTHING

1. Do up zips and close Velcro straps so that they don't harm fabrics.
2. New coloured items may contain excess dye and should therefore be washed separately the first few times.
3. Turn delicate items inside out. This reduces the risk of burling and fading.
4. Empty pockets and wash them inside out if possible.

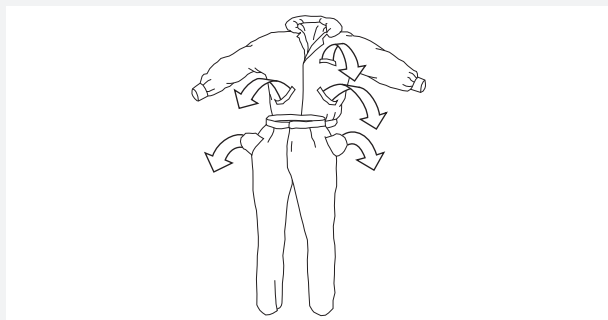

LAUNDRY LABELS

Look at the item's laundry label. The table below shows suitable wash programmes for different materials and wash loads. Using modern washing machines and detergents, for example compact detergents, you can usually wash at lower temperatures. It is a good idea to use trial and error to find out what produces the best results.

HOT WATER CONNECTION

(depending on the model)

Hot water intake has a positive effect on grease stains and certain pigment stains, such as oil, soot and coffee. Note however that difficult protein stains with albumen content (blood, milk, meat and fish) first need to be soaked in cold water as they are difficult to dissolve at temperatures above 40 °C. For the best washing results we recommend the Super wash option and pre-soaking the stained items in cold water before washing them in the machine.

COLOURED COTTON

Coloured cotton garments labelled with washing instruction 60°C must be washed at 60 °C initially to remove any excess dye. Failure to observe this advice could lead to the colour running. Use detergent without bleach to preserve the colour of the fabric.

UNBLEACHED LINEN

Unbleached linen fabrics should be washed at 60 °C, using detergent without bleach or optical brighteners. Heavily soiled linen can be washed at higher temperatures, but not too often as the heat may destroy the sheen and strength of the linen.

WOOL

These fabrics are labelled for either machine wash or for hand wash. The machine's Wool/hand wash, 30 °C programme is at least as gentle as washing by hand.

RAYON FIBRES AND SYNTHETIC FIBRES

Materials made of rayon fibres, such as viscose, and some synthetic fibres are very delicate and require much space so as not to crease. Only half fill the drum when washing and choose a spin speed of 800 rpm or lower.

NOTE!

Viscose and acetates are fragile when wet.

DETERGENTS

Eco-labelled detergents are less harmful to the environment. Detergent overdosing does not give better washing results; it merely causes a greater impact on the environment. Try to use less detergent, and increase only if you are not satisfied with the results.

NOTE!

Due to environmental concerns, we discourage the use of strong chemicals.

When using agents for bleaching or stain removal, there is a risk of rust (corrosion) and discolouration of the machine.

USING YOUR WASHING MACHINE

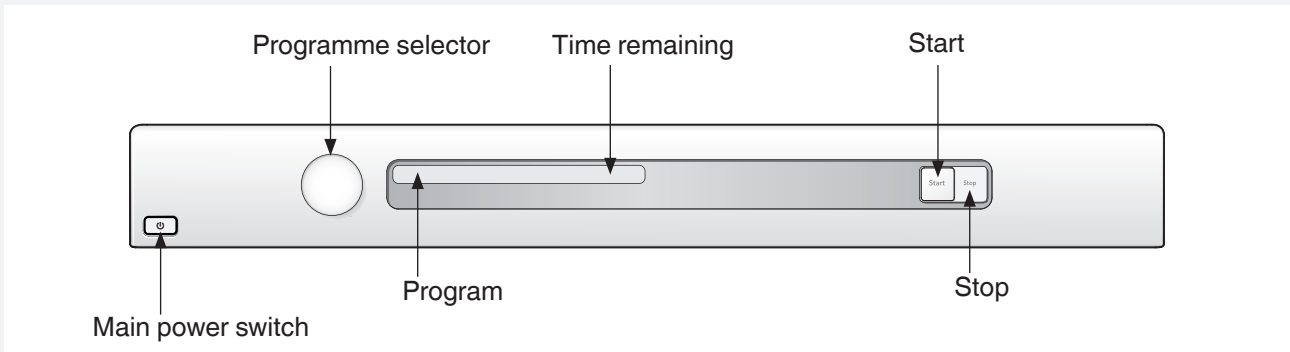

ADD DETERGENT AND FABRIC SOFTENER

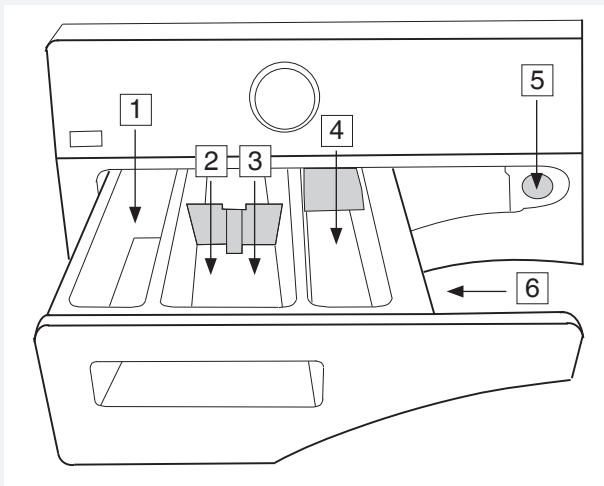

1. Pre-wash
2. Main wash with liquid detergent.
Use the separator (A).
3. Main wash with powder detergent.
Do not use the separator.
4. Fabric softener
5. Release button
6. Child safety catch

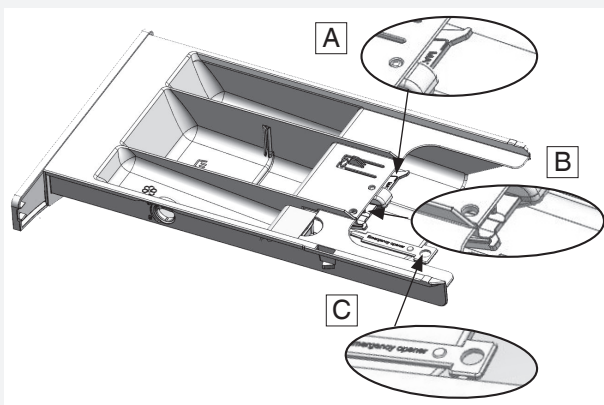

The quantity of detergent needed depends, amongst other things, on how hard the water is. See the detergent pack for details. Phone your local water company to check the water hardness in your area.

The detergent packaging will have recommendations for how much detergent you should use. The machine holds 8 kg of washing. If you only have a small amount of laundry in the machine, you can reduce the amount of detergent used.

Follow the manufacturers' recommendations as regards which type of detergent is suitable for which temperature.

Powder detergent

Pour the powder into the compartment for the main wash, and pre-wash as well if desired. Do not use the separator in the main detergent compartment.

Liquid detergent

When using a liquid detergent, observe the detergent manufacturer's recommendations. We recommend using a laundry ball with thick detergents. In the main detergent compartment, use the section wall (A). Add the detergent into the front compartment of the detergent dispenser.

Wash ball or net

If you use a wash ball or net, place it directly in the drum and select a programme without pre-wash.

NOTE!

Detergent overdosing does not give better washing results; it merely causes a greater impact on the environment.

Try using less detergent, and increase only if you are not satisfied with the results.



USING YOUR WASHING MACHINE

Fabric softener

Pour the fabric softener into the compartment with the  symbol. Follow the recommendations on the fabric softener packaging.

NOTE!

Do not fill above the compartment's maximum fill level. Otherwise fabric softener will run in too early, which impairs the washing effect.

PROGRAMME SELECTION

The display shows the programme name, the water temperature and the spin speed.

The washing machine has a number of preselected programmes when delivered from the factory. The preselected programmes can be replaced. Contact the service division for information on which programmes are available and how to alter the preselected programmes.

Heavy Wash, 90 °C

Program for heavily soiled laundry, with dirt that needs to be fully dissolved before the main wash.

Heavy Wash, 60 °C

Program for heavily soiled laundry, with dirt that needs to be fully dissolved before the main wash.

White, 90 °C

Programme for normally to heavily soiled laundry. Follow the washing instructions for each garment. 90 °C is a good temperature for white and light-coloured cotton, such as bed linen.

Standard cotton , 60 °C, 40 °C

Program for normally or heavily soiled laundry, white or coloured. The temperature can be set separately; therefore, observe the instructions indicated on the clothing worn directly on the skin. Choose 40 °C if the laundry is only lightly dirty. Spinning speed can be set to your preference. Default setting is maximum spinning speed. Program duration and amount of water will be adjusted to the amount of laundry.

White/Colour, 60 °C

Programme for normally soiled laundry, whites and colours. Follow the washing instructions for each garment. 60 °C is a good temperature for garments worn next to the skin.

White/Colour, 40 °C

Programme for normally soiled laundry, whites and colours. Follow the washing instructions for each garment.

Super quick wash, 60 °C

Fast programme for laundry that just needs freshening up. Follow the washing instructions for each garment. Garments worn next to the skin ought to be washed at 60 °C.

Super quick wash, 40 °C

Fast programme for laundry that just needs freshening up. Follow the washing instructions for each garment.

Synthetics, 40 °C

Programme for synthetics, delicate blended materials and permanent press cotton. Suitable for shirts and blouses. Follow the washing instructions for each garment. Many synthetics will come clean at 40 °C.

Wool/hand wash, 30 °C

A gentle laundry programme for wool, silk and garments that should be washed by hand. This programme has a short spin.

Rinse

This programme performs one cold rinse cycle + spin. Suitable for laundry that just needs to be dampened.

MOP wash, 90 °C

Programme suitable for different types of mop. The programme has two rinses using much water.

MOP wash, 60 °C

Programme suitable for different types of mop. The programme has two rinses using much water.

Micro fibre, 60 °C

Program for laundry made of microfibers, such as microfiber cloths. The program has three rinses, and uses a large amount of water in the first rinse.

Disinfection, 90 °C

Programme where the temperature reached during the main wash is maintained above 90 °C for 10 minutes. Disinfection at this temperature requires special detergent.

Disinfection, 60 °C

Programme where the temperature reached during the main wash is maintained above 60 °C for 60 minutes. Disinfection at this temperature requires special detergent.



USING YOUR WASHING MACHINE

Disinfection, 40 °C

Programme where the temperature reached during the main wash is maintained above 40 °C for 20 minutes. Disinfection at this temperature requires special detergent.

* Programs Disinfection (90 °C, 60 °C, 40 °C) cannot be canceled during washing program. Complete cycle will be done.

Allergy cotton, 60 °C

This program is used to wash normal to heavily soiled clothes that require special care, such as clothes for people with highly sensitive skin or skin allergies. We recommend turning the garments inside out as this will also thoroughly wash out the skin and other residues.

CLOSE THE DOOR AND PRESS THE START BUTTON

NOTE!

A few seconds after you start a programme the washing machine will begin to fill with water from both the hot and the cold supplies. If for some reason no hot water is available, the machine waits for one minute and then fills with cold water only. The wash drum does not start to rotate until it begins to fill with water.

The hot water inlet is only open for washing programs with water temperature of 40 °C or higher.

DURING THE PROGRAMME

Time remaining

“Programme started” is shown on the display.

Stopping or changing a programme

You can stop a programme by pressing the Stop button for three seconds. “Stop” appears in the display. To restart the machine, select a new programme, add any extra detergent needed and press the Start button.

NOTE!

Do not open the detergent compartment while the machine is running.



SETTINGS

HOW TO CHOOSE THE SETTINGS

1. Turn off the machine using the main power switch.
2. Press and hold the Stop button and then press the main power switch. Then press the Stop button 5 times within 10 seconds.
3. Select the setting you want to change by turning the programme selector.
4. Press the Stop once.

MAKING A SELECTION

Turn the programme selector until the desired selection is shown in the display.

SAVING A SELECTION

1. Press Stop to save the selection and return to the settings menu.
2. Press Start to go to the programme menu.

Options

Press Start to save the selection and return directly to the programme menu, if you do not want to make anymore settings.

LANGUAGE

Choose from: US English, AU English, Svenska, Dansk, Norsk, Suomi, Français, Deutsch, Italiano, Espanol, Русский, Nederlands, EU English.

CHILD-SAFE

You can activate the Child-safe start option to prevent children from starting the machine. choose "Child-safe On" or "Child-safe Off".

Deactivate the Child-safe option temporarily for three minutes by simultaneously pressing the Start and Stop buttons.

TEMPERATURE

Choose between: °C and °F.

WATER INTAKE

Connecting to both the hot and cold water supplies reduces the wash time and reduces the washing machine's electricity consumption. At the factory, the machine is set for connecting to both hot and cold water supplies. Select cold water if you want to set the machine for cold water intake only.

- Turn the programme selector to choose between: Cold and Hot.
- Press the Stop button once to save the setting.

CARE AND CLEANING

CLEANING THE DETERGENT COMPARTMENT

Pull out the detergent compartment using the release button.

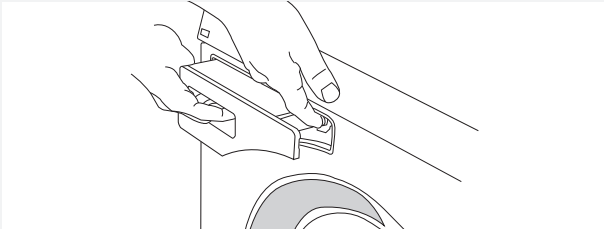

Rinse the compartment and scrub it clean. The cover in the fabric softener compartment can be removed.

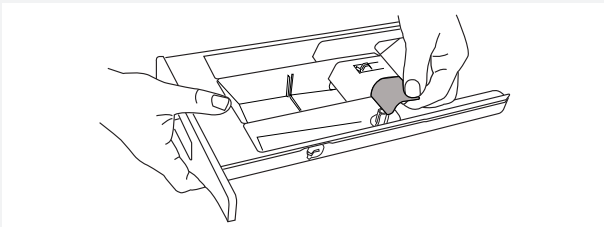

NOTE!

Do not run the detergent compartment through a dishwasher!

CLEANING THE OUTSIDE OF THE MACHINE

Clean the outside of the machine and the program panel with a mild cleaner. Do not use any solvents, as these can damage the machine.

NOTE!

Do not hose down the machine with water!

CLEANING THE INSIDE OF THE MACHINE TO AVOID UNPLEASANT SMELLS

Run a programme at 90 °C or 95 °C (depending on the model) with a small amount of detergent once a month to avoid problems with odours. It is not necessary to put any washing in the machine.

RINSE HOLES UNDER THE AGITATOR

If you suspect that objects such as nails or paper clips may have fallen into the wash drum, you should check the space under the agitator. Such objects can rust and leave marks on clothing. Nails and other sharp objects can cause holes in fabrics.

Do as follows:

1. Insert a screwdriver or the like into the hole on the agitator as illustrated and carefully pry to the left.

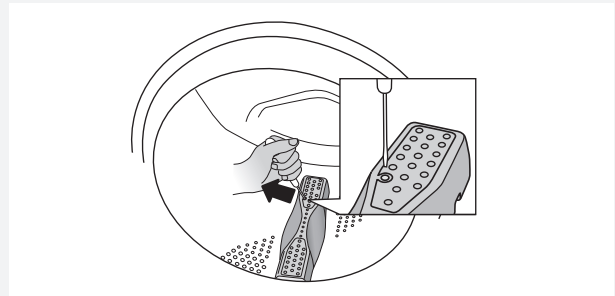

2. Use your other hand to grasp the agitator and pull it towards you.

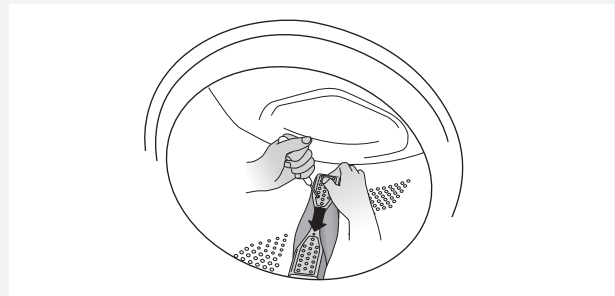

3. Lift the agitator.
4. Remove any objects.
5. Place the agitator in the mounting hole with the F-mark towards you. Ensure that all the agitator fasteners are in their holes in the drum. Push it in until it catches.

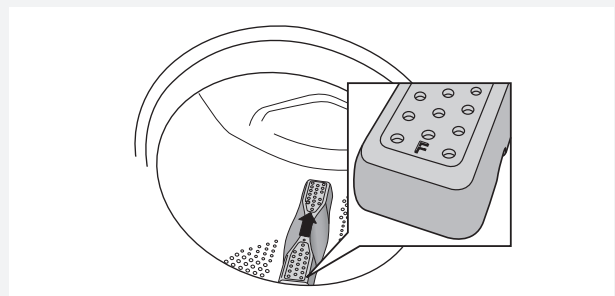



CARE AND CLEANING

IF YOU HAVE HARD WATER

If you live in an area with hard water (high limescale content), a greyish-white coating may form on the washer drum. To remove this, empty a sachet of citric acid, approx. 20 gram, into the washer drum and run any 90 °C programme. Repeat if necessary.

TROUBLESHOOTING

THE WASHER DOOR WILL NOT OPEN

- Check that the main power switch is on.
- Has the power supply been cut off? Check the house fuses (circuit breakers).

If the temperature in the drum exceeds 60 °C, then the door lock will remain activated. The door can be opened at any time with the supplied key.

OPENING THE DOOR IN AN EMERGENCY

⚠ WARNING!

The door may only be opened manually if the electric power is cut and the machine has been drained of water.

1. First empty the water from the washing machine. Press and hold the Stop button for three seconds to pump out the water. If this does not work the machine must be drained manually. See Cleaning the trap and the drainage pump in the “Care and cleaning” chapter.
2. Ensure that the main power switch is turned off and that the plug has been removed from the wall socket.
3. Take the emergency door opening key (C) (see figure in the section Using your washing machine) and insert it into the slot on the right-hand side of the washing machine door latch. The key is attached on the back wall of the detergent dispenser. Remove the detergent dispenser from the washing machine and take the door opening key.
4. Push the tool downwards to open the washer door.

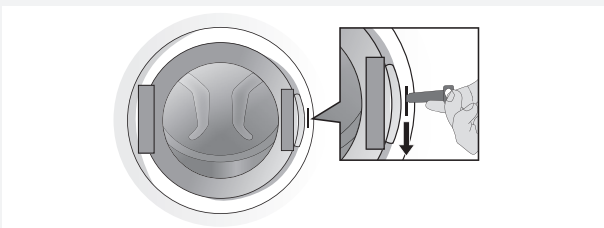

After use, store the emergency door opening key (C) in the dedicated compartment (B) (see image in the section Using your washing machine).

THE MACHINE WILL NOT START

- Is the washer door properly closed? Push it firmly. Then press the Start button.
- Is there power? Check the fuses and residual current devices (circuit breakers) in the building.

AFTER POWER FAILURE

Press the main power switch to resume the current programme.

WET WASHING STILL IN THE MACHINE

A small load can under certain circumstances cause imbalance Unbalance (see “Unbalance”). Rearrange the load and start the spin programme, or load more washing and restart the washing programme.



TROUBLESHOOTING

ERROR MESSAGES

If an error occurs during the programme a message is shown on the display. To exit the message after taking measures, turn the machine off and then back on.

The error messages that may be shown in the display are:

Close the Door

Close the washer door and press Start to start the programme.

Over flow fault

1. Shut off the water tap.
2. See "Drainage error".

Water outlet fault

Press the Stop button to empty the machine of water before opening the washer door. If this does not resolve the problem, call the service division.

Water inlet fault

Check:

- that the tap on the water pipe is open.
- that the filter in the machine's water intake is not blocked.

Action:

1. Shut off the water tap and unscrew the hose.
2. Clean the filter in the intake valve on the machine.
3. Screw the hose back on and turn on the tap.
4. Run the program again to check if the fault is fixed.
5. If this does not resolve the problem, call the service division.

Wash motor fault

Call the service division!

Unbalance

The machine stops the spin cycle if there is too much imbalance. The washing machine restarts the spin cycle and hopefully the washing is better distributed in the drum. This procedure can be repeated up to 10 times. If the machine still fails to find a good balance, the programme jumps to the next step.

The error message requires no action.

TECHNICAL INFORMATION

INFORMATION ON ENERGY LABELLING

Information sheet, in compliance with Commission Delegated Regulation (EU) No. 1061/2010

Model	WM80.C
Maximum washing load	9 kg
Energy efficiency class	A+++
Annual energy consumption (AE_c)	210 kWh per year ¹⁾
Energy consumption	
Standard cotton ◻ 60 °C with full load ($E_{t,60}$)	1,40 kWh
Standard cotton ◻ 60 °C with half load ($E_{t,60\frac{1}{2}}$)	0,78 kWh
Standard cotton ◻ 40 °C with half load ($E_{t,40\frac{1}{2}}$)	0,41 kWh
Power consumption	
Off (P_o)	0,4 W
Mode without switching off (P_i)	0,4 W
Annual water consumption (AW_c)	11660 litres per year ²⁾
Spinning efficiency class	B ³⁾
Maximum spin speed	1400 rpm
Residual moisture	53 %
Washing program	Standard cotton ◻ ⁴⁾
Program duration	
Standard cotton ◻ 60 °C with full load ($E_{t,60}$)	155 minutes
Standard cotton ◻ 60 °C with half load ($E_{t,60\frac{1}{2}}$)	108 minutes
Standard cotton ◻ 40 °C with half load ($E_{t,40\frac{1}{2}}$)	101 minutes
Noise emissions	
Washing stage	59 dB(A) re 1 pW
Spinning stage	81 dB(A) re 1 pW

- 1) Based on 220 standard washing cycles for Standard cotton ◻ for full and half load in energy saving modes. Actual power consumption will depend on the way the appliance is used.
- 2) Based on 220 standard washing cycles for Standard cotton ◻ with full and half load. Actual water consumption will depend on the way the appliance is used.
- 3) On a scale from G (the least efficient) to A (the most efficient).
- 4) Standard cotton ◻ are standard washing programs used for gathering the information for the energy label. These programs are intended for washing normally soiled cotton fabric and they are the most efficient in terms of overall power and water consumption. Actual water temperature may deviate from the temperature selected for the washing cycle.



TECHNICAL INFORMATION

INFORMATION FOR TEST INSTITUTE

Energy labelling

European test standard:	EN 60456
Washing program:	Standard cotton  , 1400 rpm, 9 kg cotton
Connection:	Cold water 15 °C
Test method for noise measurement:	IEC-60704-2-4

TECHNICAL DATA

Height:	850 mm
Width:	595 mm
Depth:	700 mm
Weight:	94 kg
Cylinder volume:	80 l
Max. washing capacity:	9 kg
Spin speed (rpm):	400-1400
Sound pressure level:	The sound pressure level is below 70 dB(A)
Rated power:	See type plate.
Heater output:	See type plate.
Water pressure:	0,1-1 MPa 1-10 kp/cm ² 10-100 N/cm ²
Maximum inlet water temperature:	90 °C
Wash drum and liquid compartment material:	Stainless steel
Outer casing material:	Powder-coated and hot-galvanized sheet steel or stainless steel.
Water connection:	1.5 m pex pipe
Drain:	1.6 m polypropylene hose 3/4 BSP connection

INSTALLATION

POSITIONING THE WASHING MACHINE

The washing machine can be installed as a built-in or freestanding unit. Place the machine on a firm surface with easy access to the plug.

A. Built-in

The washing machine can be installed under a counter top with a working height of 850-900 mm. Leave a 5 cm space around the entire machine, including between the rear edge of the top cover and the wall behind it.

B. Freestanding

The washing machine can be positioned beside or under a tumble dryer.

ADJUSTING THE FEET

Keep the noise that the machine produces to a minimum by adjusting the feet so that the machine is steady and balanced on the floor. Tighten the lock nuts.

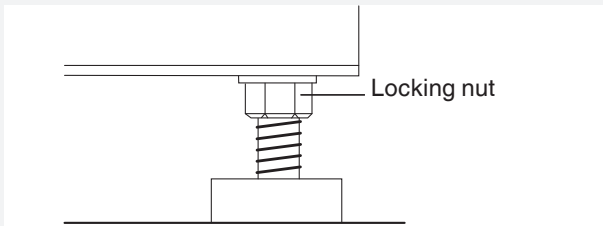

CONNECTION TO WATER SUPPLY

Water connection should be carried out by an appropriately qualified person. Connect the machine using the accompanying supply hose. Water pressure should be 0.1–1MPa (approx. 1–10kp/cm² ; 10–100N/cm²). There should be a stopcock on the water pipe.

If the pipes are newly installed, it may be wise to flush them through so that any dirt is washed away. Otherwise, dirt can clog the filter in the machine's water intake and cut off the water supply.

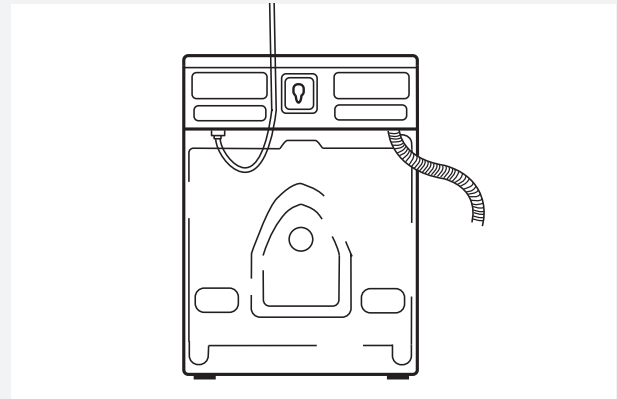

Use only the supply hose supplied with the machine. Do not re-use old hoses or other loose supply hoses.

Water intake

At the factory, the machine is set for connecting to both hot and cold water supplies. The machine can be set for cold water intake only. See the section "Settings".

Hot water connection

(depending on the model)

A few seconds after you start a programme the washing machine will begin to fill with water from both the hot and the cold supplies. If for some reason no hot water is available, the machine waits for one minute and then fills with cold water only. The wash drum does not start to rotate until it begins to fill with water.

If you choose to connect your ECO-machine to only the cold water it is important that you shut off the hot water connection. Now select "Hot water Off". If your machine is connected to both hot and cold water, you should select "Hot water On".

If the appliance is not connected to the hot water line, then deactivate the function in the User Menu. (See chapter Settings.)

INSTALLATION

DRAINAGE CONNECTION

A water outlet hose is included with the machine. This is attached to the machine's outlet and routed to a floor drain or drainage pipe.

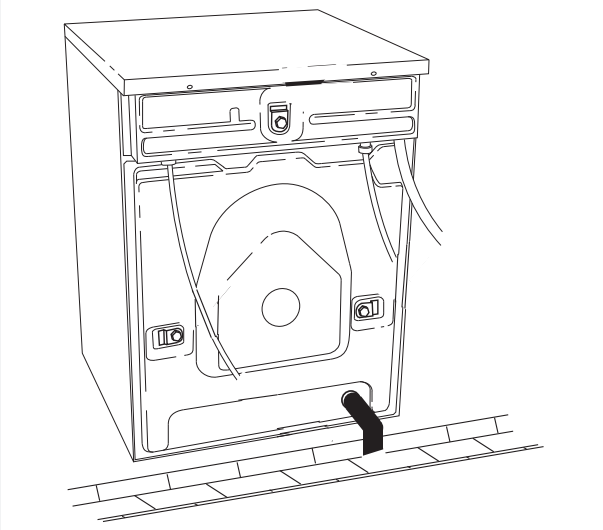

NOTE!

The height of the mouth of the outlet hose must be lower than the lowest part of the outlet valve.

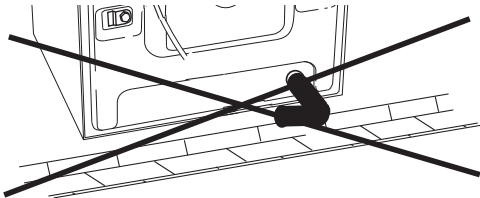

ELECTRICAL INSTALLATION

If the machine is delivered from the factory with a plug attached it can be connected to an earthed wall socket. Otherwise, a permanent connection using a multipolar circuit breaker must be made by a qualified professional.

Connection on delivery

The machine comes with 3-Phase, 400 V, 50 Hz, heat output 7000 W and fused 16 A. If a residual current device is being used, this should be type A.

NOTE!

Repairs and maintenance relating to safety or performance must be carried out by a qualified professional.

Coin operation

The machine is prepared for coin operation. Such installation must be carried out by a qualified professional.

The installation requires a connection cable to power the coin meter. This connection cable can be ordered using the factory art. no. 92 090 95.

The coin meter shall be able to short circuit two signal lines for periods of up to 10 minutes. This is to give the user time to load the machine, choose a programme and start the programme after putting the coins in.

“Insert coin” appears on the display when the machine is started with the main power switch.

BEFORE CONTACTING THE SERVICE DIVISION

BEFORE CONTACTING THE SERVICE DIVISION

Before you contact the service division, make sure that you know the model designation (1), type designation (2) and serial number (3).

The model designation can be found on the panel. The type designation and serial number can be found on the type plate on the inside of the washer door.

NOTE!

For repairs and maintenance, original spare parts must be used.

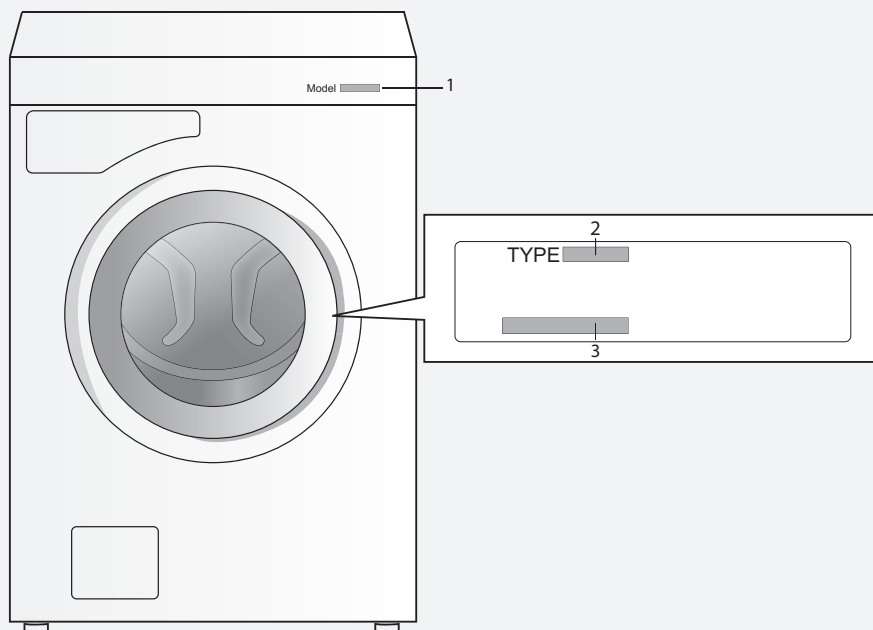

PROGRAMME CHART

Program	Prewash	Temp. °C	Number of Rinses	Spin Speed rpm	Max. load (kg)	Water consumption (approx. liter)			Energy consumption (approx. kWh)	Programme time (approx. hrs and min.)
						Hot ¹⁾	Cold ²⁾	Sum ¹⁾⁺²⁾		
Standard cotton		60	3	1400	9	26	46	72	1,40	3:00
Standard cotton		40	3	1400	9	26	46	72	0,70	2:55
Heavy wash	X	90	3	1400	9	12	70	82	2,60	1:35
Heavy wash	X	60	3	1400	9	12	63	75	1,40	1:20
White		90	3	1400	9	26	49	75	2,30	1:25
Standard cotton ◻		60	2	1400	9		57	57	1,20	2:35
Standard cotton ◻		40	2	1400	9		57	57	0,60	2:25
White / Colour		60	3	1400	9	26	42	68	1,10	1:10
White / Colour		40	3	1400	9	26	42	68	0,50	1:00
Super quick wash		60	3	800	4,5	15	42	57	0,80	0:35
Super quick wash		40	3	800	4,5	15	42	57	0,50	0:30
Synthetics		40	3	600	4,5	15	38	53	0,30	0:30
Wool/Hand wash		30	3	600	3		90	90	0,35	0:30
Rinse			1	1400	4,5		20	20	0,05	0:20
MOP wash	X	90	2	1400	9	10	70	80	2,80	1:25
MOP wash	X	60	2	1400	9	10	62	72	1,60	1:10
Micro fibre		60	3	1400	9	26	42	68	0,70	1:00
Micro fibre		40	3	1400	9	26	42	68	0,50	0:50
Disinfection	X	90	2	1400	9	35	62	97	3,00	1:25
Disinfection	X	60	3	1400	9	35	55	90	2,30	2:20
Disinfection	X	40	3	1400	9	35	55	90	1,10	1:30
Allergy cotton		90	6	1400	9	26	79	105	3,00	2:50
Allergy cotton		60	6	1400	9	26	72	98	1,90	2:30
Allergy cotton		40	6	1400	9	26	72	98	1,10	2:20
Allergy synthetics		60	6	1200	4,5	15	75	90	1,20	2:00
Allergy synthetics		40	6	1200	4,5	15	75	90	0,70	1:55
Cleaning		90	3	1200	/	30	100	130	2,85	1:15
Program A										
Program B										
Program C										

1) Connection to Hot water, approx. 55 °C.

2) Connection to Cold water, approx. 15 °C.

The above table presents a few examples of the energy, water and time consumption of a few different programme settings. Consumption can vary depending on water pressure, water hardness, water supply temperature, room temperature, load weight and content, variations in the power supply and selected options.



PROGRAMME CHART

Adjustment of the displayed washing time

Advanced technology allows the appliance to sense the amount of laundry and add the required amount of water during the washing process. Depending on the washing load, washing time can be longer or shorter and the time displayed will be adjusted accordingly.

Moreover, displayed washing time may change due to differences in inlet water temperature. At low inlet water temperatures, washing time can be longer; at higher temperatures, it can be shorter.

Unevenly distributed laundry or lumps of laundry in the washing machine drum can cause problems such as vibration and noisy operation. The appliance can sense such lumps and will try to redistribute the laundry. Smaller loads (e.g. one towel, one sweater, one bathrobe etc.) or clothes made of materials with special geometrical properties are virtually impossible to distribute evenly across the washing machine drum (slippers, large items etc.). This results in several attempts to redistribute the laundry, which in turn leads to longer program duration.

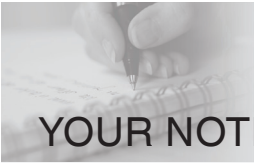

YOUR NOTES

A vertical column of 30 horizontal dotted lines for writing notes on the left side of the page.

A vertical column of 30 horizontal dotted lines for writing notes on the right side of the page.

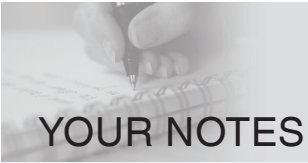

YOUR NOTES

A large, light gray rectangular area occupies the center of the page, serving as a workspace for notes. It is divided into two vertical columns by a faint, dotted line. Each column contains numerous horizontal dotted lines, providing a guide for writing. The lines are evenly spaced and extend across the width of each column, creating a structured yet flexible space for capturing thoughts and information.

QUICK GUIDE

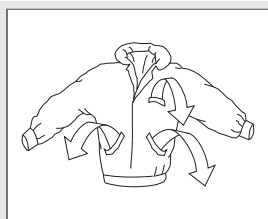

1.

SORT THE WASHING, OPEN THE WASHING MACHINE DOOR AND LOAD THE WASHING

Refasten zips.

Look at the item's laundry label.

Sort the washing according to how soiled it is, colour and material.

NB! Place underwired bras in a laundry net.

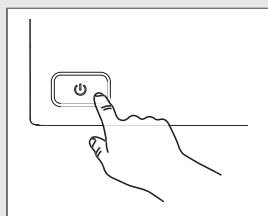

2.

TURN ON THE MAIN POWER SWITCH

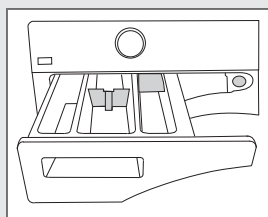

3.

ADD DETERGENT AND FABRIC SOFTENER, AS REQUIRED

The detergent packaging will have recommendations for how much detergent you should use. With only a small amount of washing in the machine, you can reduce the amount of detergent used.

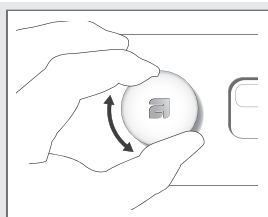

4.

SELECT A PROGRAMME

You select a programme by turning the programme selector. The selected programme is shown in the display.

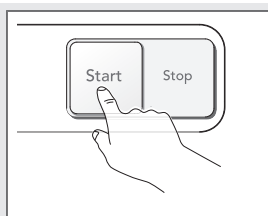

5.

CLOSE THE WASHER DOOR AND PRESS THE START BUTTON

The time remaining is shown in hours and minutes.

We reserve the right to make changes.

ASKO

Gorenje, Partizanska 12, 3320 Velenje, Slovenija

www.asko.com