

EN

# **gorenje**

**DETAILED  
INSTRUCTIONS FOR USE  
OF UPRIGHT  
REFRIGERATOR AND  
FREEZER**



We thank you for the confidence you have shown by purchasing our appliance which is designed to simplify your life. To make the use of the product easier, we have supplied detailed instructions for use, and installation instructions supplied on a separate sheet. The instructions should allow you to learn about your new appliance as quickly as possible.

We wish you find a lot of pleasure in its use.

**The appliance is intended solely for household use.**

**The refrigerator** is intended for storing fresh food at temperatures above 0°C. **The freezer** is intended for freezing fresh food and for long-term storage of frozen food (up to one year, depending on the type of food).

Please visit our website where you can enter your appliance model number, indicated on the rating plate or the warranty sheet, to find detailed description of your appliance, tips on use, troubleshooting, service information, instructions for use etc.



<http://www.gorenje.com>



Important safety warning

# CONTENTS

---

|   |  |
|---|--|
| <b>4 IMPORTANT NOTES AND PRECAUTIONS</b><br>..... | <b>INTRODUCTION</b>                                  |
| <b>4 SAFETY AND WARNING INFORMATION</b>           |  |
| <b>11 INSTALLING YOUR NEW APPLIANCE</b><br>.....  | <b>APPLIANCE<br/>DESCRIPTION</b>                     |
| <b>13 APPLIANCE DESCRIPTION</b><br>.....          |  |
| <b>14 OPERATING THE APPLIANCE</b><br>.....        |  |
| <b>17 USING YOUR APPLIANCE</b>                    |  |
| <b>22 HELPFUL HINTS AND TIPS</b><br>.....         | <b>DEFROSTING<br/>AND CLEANING<br/>THE APPLIANCE</b> |
| <b>23 CLEANING AND CARE</b>                       |  |
| <b>25 TROUBLESHOOTING</b><br>.....                | <b>MISCELLANEOUS</b>                                 |
| <b>27 DISPOSAL OF THE APPLIANCE</b>               |  |

# IMPORTANT NOTES AND PRECAUTIONS

---



## SAFETY AND WARNING INFORMATION

For your safety and correct usage, before installing and first using the appliance, read this user manual carefully, including its hints and warnings. To avoid unnecessary mistakes and accidents, it is important to make sure that all people using the appliance are thoroughly familiar with its operation and safety features. Save these instructions and be sure that they remain with the appliance if it is moved or sold, so that anyone using it throughout its life, will be properly informed on its usage and safety notices. For the safety of life and property, keep the precautions of these user's instructions as the manufacturer is not responsible for damages caused by omission.

### **Safety for children and others who are vulnerable people**

According to EN standard

This appliance can be used by children aged from 8 years and above and persons with reduced physical, sensory or mental capabilities or lack of experience and knowledge if they have been given supervision or instruction concerning use of the appliance in a safe way and understand the hazards involved. Children shall not play with the appliance. Cleaning and user maintenance shall not be made by children without supervision.

Children aged from 3 to 8 years are allowed to load and unload refrigerating appliances.

According to IEC standard

This appliance is not intended for use by persons (including children) with reduced physical, sensory or mental capabilities, or lack of experience and knowledge, unless they have been given supervision or instruction concerning use of the appliance by a person responsible for their safety.

- Keep all packaging away from children as there is risk of suffocation.
- If you are discarding the appliance, pull the plug out of the socket, cut the connection cable (as close to the appliance as you can) and remove the door to prevent children playing from suffering an electric shock or from closing themselves inside it. I
- If this appliance, featuring a magnetic door seals, is to replace an older appliance having a spring lock (latch) on the door or lid, be sure to make the spring lock unusable before you discard the old appliance. This will prevent it from becoming a death trap for a child.



### **General safety**

- **WARNING** —This appliance is intended to be used in household and similar applications such as
  - staff kitchen areas in shops, offices and other working environments;
  - farm houses and by clients in hotels, motels and other residential type environments;
  - bed and breakfast type environments;
  - catering and similar non-retail applications.

- WARNING — Do not store explosive substances such as aerosol cans with a flammable propellant in this appliance.
- WARNING — If the supply cord is damaged, it must be replaced by the manufacturer, its service agent or similarly qualified persons in order to avoid a hazard.
- WARNING — Keep ventilation openings, in the appliance enclosure or in the built-in structure, clear of obstruction.
- WARNING — Do not use mechanical devices or other means to accelerate the defrosting process, other than those recommended by the manufacturer.
- WARNING — Do not damage the refrigerant circuit.
- WARNING — Do not use electrical appliances inside the food storage compartments of the appliance, unless they are of the type recommended by the manufacturer.
- WARNING — The refrigerant and insulation blowing gas are flammable. When disposing of the appliance, do so only at an authorized waste disposal centre. Do not expose to flame. WARNING —When positioning the appliance, ensure the supply cord is not trapped or damaged.
- WARNING —Do not locate multiple portable socket-outlets or portable power supplies at the rear of the appliance.

## **Replacing the LED**

- WARNING—The LED light must not be replaced by the user! If the LED light is damaged, contact the customer helpline for assistance.

## **Refrigerant**

The refrigerant isobutene (R600a) is contained within the refrigerant circuit of the appliance, a natural gas with a high level of environmental compatibility, which is nevertheless

flammable. During transportation and installation of the appliance, ensure that none of the components of the refrigerant circuit becomes damaged. The refrigerant (R600a) is flammable.

- **WARNING** — Refrigerators contain refrigerant and gases in the insulation. Refrigerant and gases must be disposed of professionally as they may cause eye injuries or ignition. Ensure that tubing of the refrigerant circuit is not damaged prior to proper disposal.



### **Caution: risk of fire**

If the refrigerant circuit should be damaged:

- Avoid opening flames and sources of ignition.
- Thoroughly ventilate the room in which the appliance is situated.

It is dangerous to alter the specifications or modify this product in any way.

Any damage to the cord may cause a short circuit, fire, and/or electric shock.



### **Electrical safety**

- The power cord must not be lengthened.
- Make sure that the power plug is not crushed or damaged. A crushed or damaged power plug may overheat and cause a fire.
- Make sure that you can access the main plug of the appliance.
- Do not pull the main cable.
- If the power plug socket is loose, do not insert the power plug. There is a risk of electric shock or fire.

- You must not operate the appliance without the interior lighting lamp cover.
- The fridge is only applied with power supply of single phase alternating current of 220~240V/50Hz. If fluctuation of voltage in the district of user is so large that the voltage exceeds the above scope, for safety sake, be sure to apply A.C. Automatic voltage regulator of more than 350W to the fridge. The fridge must employ a special power socket instead of common one with other electric appliances. Its plug must match the socket with ground wire.

### **Daily use**

- Do not store flammable gass or liquids in the appliance, There is a risk of an explosion.
- Do not operate any electrical appliances in the appliance (e.g.electric ice cream makers,mixers etc.).
- When unplugging always pull the plug from the mains socket,do not pull on the cable.
- Do not place hot items near the plastic components of this appliance.
- Do not place food products directly against the air outlet on the rear wall.
- Store pre-packed frozen food in accordance with the frozen food manufacture's instructions.
- The appliances manufactures storage recommendations should be strictly adhered to.Refer to relrelevant instructions for storage.
- Do not place carbonated or fizzy drinks in the freeze compartment as it creates pressure on the container,which may cause it to explode,resulting in damage to the appliance.
- Frozen food can cause frost burns if consumed straight from the freezer compartment.
- Do not place the appliance in direct sunlight.



- Keep burning candles, lamps and other items with naked flames away from the appliance so that do not set the appliance on fire.
- The appliance is intended for keeping food stuff and/ or beverages in normal household as explained in this instruction booklet The appliance is heavy. Care should be taken when moving it.
- Do not remove nor touch items from the freezer compartment if your hands are damp/wet, as this could cause skin abrasions or frost/freezer burns.
- Never use the base, drawers, doors etc. to stand on or as supports.
- Frozen food must not be refrozen once it has been thawed out.
- Do not consume ice popsicles or ice cubes straight from the freezer as this can cause freezer burn to the mouth and lips.
- To avoid items falling and causing injury or damage to the appliance, do not overload the door racks or put too much food in the crisper drawers.
- WARNING - Food needs to be packed into bags before it is put into the refrigerator. Liquids need to be stored in bottles or capped containers in order to avoid a spill, as the design structure of the product is not easy to clean.

## **caution!**

### **Care and cleaning**

- Before maintenance, switch off the appliance and disconnect the mains plug from the mains socket.
- Do not clean the appliance with metal objects, steam cleaner, ethereal oils, organic solvents or abrasive cleansers.
- Do not use sharp objects to remove frost from the appliance. Use a plastic scraper.

## **Installation Important!**

- For electrical connection carefully, follow the instructions given in this manual.
- Unpack the appliance and check if there are damages on it. Do not connect the appliance if it is damaged. Report possible damages immediately to the place you bought it. In this case retain packing.
- It is advisable to wait at least four hours before connecting the appliance to allow the oil to flow back in the compressor.
- Adequate air circulation should be around the appliance, lacking this leads to overheating. To achieve sufficient ventilation, follow the instructions relevant to installation. Wherever possible the back of the product should not be too close to a wall to avoid touching or catching warm parts (compressor, condenser) to prevent the risk of a fire, follow the instructions relevant to installation.
- The appliance must not be locate close to radiators or cookers.
- Make sure that the mains plug is accessible after the installation of the appliance

## **Service**

- Any electrical work required to do the servicing of the appliance should be carried out by qualified electrician or competent person.
- This product must be serviced by an authorized Service Center, and only genuine spare parts must be used.
  - 1) If the appliance is Frost Free.
  - 2) If the appliance contains freezer compartment.

# INSTALLING YOUR NEW APPLIANCE

- Before using the appliance for the first time, you should review the following tips.

## Ventilation of appliance

In order to improve efficiency of the cooling system and save energy, it is necessary to maintain good ventilation around the appliance for the dissipation of heat. For this reason, sufficient clear space should be available around the refrigerator.

Suggest: It is advisable for there to be 75mm of space from the back to the wall, at least 100mm from its top, at least 100mm from its side to the wall and a clear space upfront to allow the freezer door to open 135° and refrigerator door to open 135°. See in follow diagrams. Please refer to the diagrams below.

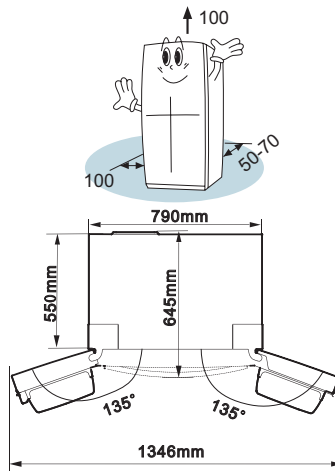

## Note:

- This appliance performs well within the climate class showed in the table below. It may not work properly if being left at a temperature above or below the indicated range for a long period.

| Class            | Temperature           |
|------------------|-----------------------|
| SN (subnormal)   | from +10 °C to +32 °C |
| N (normal)       | from +16 °C to +32 °C |
| ST (subtropical) | from +16 °C to +38 °C |
| T (tropical)     | from +16 °C to +43 °C |

- Stand your appliance in a dry place to avoid damage moisture.
- Keep the appliance out of direct sunlight, rain or frost. Stand the appliance away from heat sources such as stoves, fires or heaters.

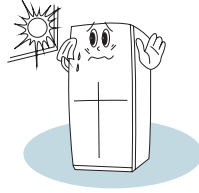

### Leveling of appliance

- For sufficient leveling and air circulating in the lower rear section of the appliance, the bottom feet may need to be adjusted, You can adjust them by your fingers or a suitable spanner.

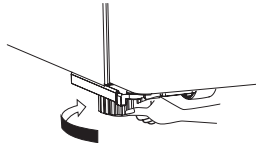

- To allow the doors to self-close, tilt back the top backwards for about 10 mm.

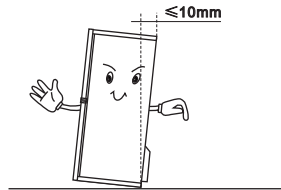

### Flipper clapboard

- Before closing the fridge door, the flipper clapboard should be correctly in position to allow the door to close properly. See pictures below.

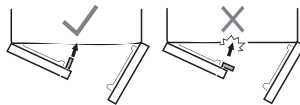

**Note:** It is normal that the flipper clapboard feels hot as there is a heater installed inside the clapboard to prevent dewing.

# APPLIANCE DESCRIPTION

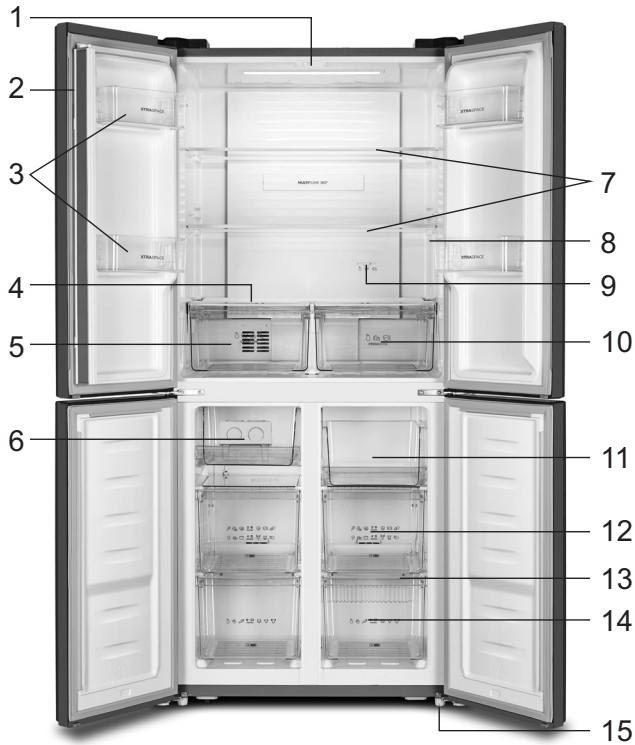

1. Fridge LED light
2. Door seal
3. Fresh door rack
4. Crisper cover
5. Fruit & vegetables box
6. Twist Ice tray (inside)
7. Glass shelves
8. Display panel

9. Temperature adjusting slide block
10. Cool fresh box
11. Upper freezer tray
12. Middle freezer drawer
13. Glass plates
14. Lower freezer drawer
15. Adjustable bottom feet

**Note:** Due to unceasing modification of our products, your refrigerator may be slightly different from this instruction manual, but its functions and using methods remain the same. To get more space in the freezer, you can remove drawers (except lower freezer drawer) and ice tray.

# OPERATING THE APPLIANCE

Use your appliance according to the following control regulations, your appliance has the corresponding functions and modes as the control panels showed in the pictures below. When the appliance is powered on for the first time, the backlighting of the icons on display panel will be illuminated for 3 seconds, then the display panel starts working. If no buttons have been pressed or the fridge doors are closed, the backlighting will turn off after 1 minutes.

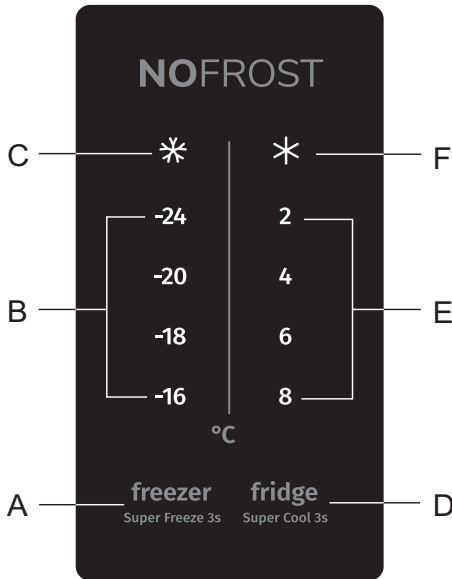

- A** Freezer compartment temperature setting and Super Freeze key
- B** Freezer compartment temperature indicator
- C** Super Freeze function indicator
- D** Fridge compartment temperature setting and Super Cool key
- E** Fridge compartment temperature indicator
- F** Super Cool function indicator

## Controlling the temperature

We recommend that when you start your refrigerator for the first time, the temperature for the refrigerator is set to 4°C, and the freezer to -18°C. If you want to change the temperature, follow the instructions below.

Caution! When you set a temperature, you set an average temperature for the whole refrigerator cabinet. Temperatures inside each compartment may vary from the temperature values displayed on the panel, depending on how much food you store and where you place them. Ambient temperature may also affect the actual temperature inside the appliance.

## 1. Freezer

### freezer

Press the middle part of button **A** (**Super Freeze 3s**) to set the freezer temperature between  $-16^{\circ}\text{C}$  and  $-24^{\circ}\text{C}$  to suit your desired temperature, and the freezer temperature indicator will display corresponding value according to the following sequence.

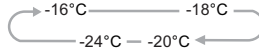

## 2. Fridge

### fridge

Press the middle part of button **D** (**Super Cool 3s**) to set your desired fridge temperature between  $8^{\circ}\text{C}$  and  $2^{\circ}\text{C}$ , and the fridge temperature indicator will display corresponding value according to the following sequence.

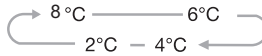

## 3. Super Freeze

Super Freeze can rapidly lower frozen temperature and freeze your food substantially faster than usual.

- This feature also helps to keep vitamins and nutrition of fresh food for longer period.

### freezer

- Press the middle part of **A** (**Super Freeze 3s**) button for 3 seconds to activate the super freeze function. The light **C** (**\***) will be illuminated and the freezer temperature indicator will display  $-24^{\circ}\text{C}$ .
- Super freeze automatically switches off after 52 hours.
- When super freeze function is on you can switch off super freeze function by

### freezer

pressing the middle part of **A** (**Super Freeze 3s**) button and the freezer temperature setting will revert back to the previous setting.

**Note:** When selecting the Super Freeze function, ensure there are no bottled or canned drinks (especially carbonated drinks) in the freezer compartment. Bottles and cans may explode.

## 4. Super Cool

Super Cool can refrigerate the food quicker and, keep food fresh for a longer period.

### fridge

- Press the middle part of **D** (**Super Cool 3s**) button for 3 seconds to activate this function. The light **F** (✱) will be illuminated and the fridge temperature indicator will display 2°C.
- Super cool automatically switches off after 6 hours.
- When super cool function is on you can switch it off by pressing the middle part of **D** (**Super Cool 3s**) button and the refrigerator temperature setting will revert back to the previous setting.



# USING YOUR APPLIANCE

---

Your appliance has the accessories as the »Description of the appliance» showed in general, with this part instruction you can have the right way to use them.

## Door rack

It is suitable for the storage of eggs, canned liquid, bottled drinks and packed food, etc. Do not place too many heavy things in the racks.

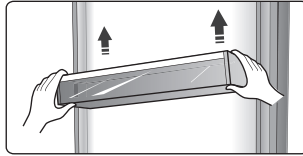

All the door racks are completely removable for cleaning.

**Note:** There are egg trays in the rack.

## Shelf

There are two glass shelves in refrigerator chamber. They can be adjusted to various heights as needed.

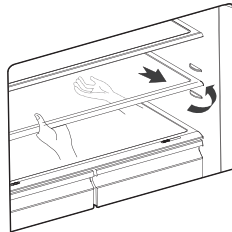

- When you remove the shelves, gently pull them forward until the shelf comes clear of the shelf guides.
- When you return the shelves, make sure there is no obstacle behind and gently push the shelf back into the position.

## Crisper cover

- It is for avoiding the vegetable losing moisture. You can adjust the humidity inside the crispers by using the sliding block.

## Crisper and humidity control

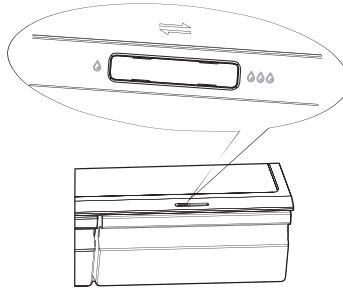

- The humidity control adjust the airflow in the crisper; higher airflow results in lower humidity. Slide the humidity control to the right in order to increase humidity.
- High humidity settings are recommended for vegetables, while low humidity is suitable for preservation of fruit.

## Crispers

The crisper, mounted on telescopic extension slides, is for storing vegetables and fruits.

## Cool fresh box

- You can change the temperature of the cool fresh box into three modes, "Fridge", "Chill" and "Fresh" by using the temperature adjusting slide block. This means you can store beverages and food under suitable temperatures.

**Note:** The "Fresh" option is about 2-3°C lower than that in the refrigerator chamber. In certain mode, The food surface may be slightly frozen.

- It is used to store fish, meat and other erodible food.
- Applies to certain modes only.

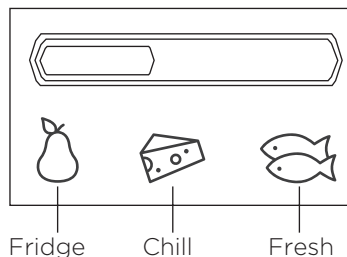

### Using your freezer drawer

The freezer drawers are suitable for storage of foods required to be frozen, such as meat, ice cream and others.

**Caution!** Ensure that bottles are not stored in the freezer as freezing may cause the bottle to break.

### Using the refrigerator chamber

The refrigerator chamber is suitable for storage of vegetable and fruits. Separate packing of different foods is recommended to avoid losing moisture or flavor permeating into other foods.

#### **Caution!**

Never close doors while the shelves, crisper and/or telescopic slides are extended. It may damage the unit.

Follow these simple instructions to remove the crisper chamber, or freezer drawer, for cleaning. Empty the crisper chamber; pull it out to fully open position. Lift the crisper from the lateral slides. Push the slides fully in to avoid damage when closing the door.

### Twist Ice tray

It is used to make ice cubes. To make ice cubes, please fill water into the ice cube trays and the water level shall not exceed the top line (ideally eighty percent of the ice tray volume). Place the tray into the freezer compartment and wait at least two hours for the ice cubes to be formed. After the cubes are formed, gently twist the tray to separate the cubes and trays.



**Note:** If the ice tray is used for the first time or has not been used for a long time, please clean it before using.

**To avoid contamination of food, please respect the following instructions**

- Opening the door for long periods can cause a significant increase of the temperature in the compartments of the appliance.
- Clean regularly surfaces that can come in contact with food and accessible drainage systems.
- Store raw meat and fish in suitable containers in the refrigerator, so that it is not in contact with or drip onto other food.
- Two-star frozen-food compartments are suitable for storing pre-frozen food, storing or making ice cream and making ice cubes.
- One-, two- and three-star compartments are not suitable for the freezing of fresh food.

| Order | Compartments TYPE | Target storage temp.[°C] | Appropriate food   |
|-------|-------------------|--------------------------|--|
| 1     | Fridge            | +2 ≤ +8                  | Eggs, cooked food, packaged food, fruits and vegetables, dairy products, cakes, Drinks and other foods which are not suitable for freezing.  |
| 2     | (**)* - Freezer   | ≤ -18                    | Seafood (fish, shrimp, shellfish), freshwater aquatic products and meat products (recommended time is 3 months - nutrition values and taste decrease with time), suitable for frozen fresh food.       |
| 3     | *** - Freezer     | ≤ -18                    | Seafood (fish, shrimp, shellfish), freshwater aquatic products and meat products (recommended time is 3 months - nutrition values and taste decrease with time). Not suitable for freezing fresh food. |
| 4     | ** - Freezer      | ≤ -12                    | Seafood (fish, shrimp, shellfish), freshwater aquatic products and meat products (recommended time is 2 months - nutrition values and taste decrease with time). Not suitable for freezing fresh food. |
| 5     | * - Freezer       | ≤ -6                     | Seafood (fish, shrimp, shellfish), freshwater aquatic products and meat products (recommended time is 1 month - nutrition values and taste decrease with time). Not suitable for freezing fresh food.  |

|   |            |               |   |
|---|------------|---------------|---|
| 6 | 0 star     | $-6 \leq 0$   | Fresh pork, beef, fish, chicken, some packaged processed foods, etc. (Recommended to eat within the same day, preferably not later than 3 days) .<br>Partially packed/wrapped up encapsulated processed foods (non-freezable foods)                                 |
| 7 | Chill      | $-2 \leq +3$  | Fresh/frozen pork, beef, chicken, freshwater aquatic products, etc. (7 days below 0 °C and above 0 °C is recommended for consumption within that day, preferably no more than 2 days). Seafood (less than 0 for 15 days, it is not recommended to store above 0 °C) |
| 8 | Fresh Food | $0 \leq +4$   | Fresh pork, beef, fish, chicken, cooked food, etc. (Recommended to eat within the same day, preferably no more than 3 days)   |
| 9 | Wine       | $+5 \leq +20$ | Red wine, white wine, sparkling wine etc.   |

**Note: please store different foods according to the compartments or target storage temperature of your purchased products.**

- If the refrigerating appliance is left empty for long periods, switch off, defrost, clean, dry, and leave the door open to prevent mould developing within the appliance.

**Water dispenser cleaning (special for water dispenser products):**

- Clean water tanks if they have not been used for 48 h; flush the water system.

# HELPFUL HINTS AND TIPS

---

## Energy saving tips

We recommend that you follow the tips below to save energy.

- Try to avoid keeping the door open for long periods.
- Ensure the appliance is away from any sources of heat (Direct sunlight, electric oven or cooker etc.)
- Don't set the temperature colder than necessary.
- Don't store warm food or evaporating liquid in the appliance.
- Place the appliance in a well ventilated, humidity free room. Please refer to Installing your new appliance chapter
- If the diagram shows the correct combination for the drawers, crisper and shelves, do not adjust the combination as this designed to be the most energy efficient configuration.

## Hints for refrigeration

- Do not place hot food directly into the refrigerator or freezer, the internal temperature will increase resulting in the compressor having to work harder and will consume more energy.
- Do cover or wrap the food, particularly if it has a strong flavor.
- Place food properly so that air can circulate freely around it.
- Meat (All Types) Wrap in polythene food: wrap and place on the glass shelf above the vegetable drawer. Always follow food storage times and use by dates suggested by manufacturers.
- Cooked food, cold dishes, etc.: They should be covered and may be placed on any shelf.
- Fruit and vegetables: They should be stored in the special drawer provided.
- Butter and cheese: Should be wrapped in airtight foil or plastic film wrap.
- Milk bottles: Should have a lid and be stored in the door racks.
- It is recommended to label and date each frozen package in order to keep track of the storage times.

## Hints for the storage of frozen food

- Ensure that frozen food has been stored correctly by the food retailer.
- Once defrosted, food will deteriorate rapidly and should not be re-frozen. Do not exceed the storage period indicated by the food manufacturer.

## Switching off your appliance

If the appliance needs to be switched off for an extended period, the following steps should be taken to prevent mould on the appliance.

1. Remove all food.
2. Remove the power plug from the mains socket.
3. Clean and dry the interior thoroughly.
4. Ensure that all the doors are wedged open slightly to allow air to circulate.

# CLEANING AND CARE

---

For hygienic reasons the appliance (including exterior and interior accessories) should be cleaned regularly (at least every two months).

## **Warning!**

The appliance must not be connected to the mains during cleaning. Danger of electrical shock! Before cleaning switch the appliance off and remove the plug from the mains socket.

## **Exterior cleaning**

To maintain good appearance of your appliance, you should clean it regularly.

- Wipe the digital panel and display panel with a clean, soft cloth.
- Spray water onto the cleaning cloth instead of spraying directly on the surface of the appliance. This helps ensure an even distribution of moisture to the surface.
- Clean the doors, handles and cabinet surfaces with a mild detergent and then wiped dry with a soft cloth.

## **Warning!**

- Do not use sharp objects as they are likely to scratch the surface.
- Do not use Thinner, Car detergent, Clorox, ethereal oil, abrasive cleansers or organic solvent such as Benzene for cleaning. They may damage the surface of the appliance and may cause fire.

## **Interior cleaning**

You should clean the appliance interior regularly. It will be easier to clean when food stocks are low. You can remove the drawers and shelves for a more thorough clean. Wipe the inside of the freezer with a weak solution of bicarbonate of soda, and then rinse with warm water using a wrung-out sponge or cloth. Wipe completely dry before replacing the shelves and baskets. Thoroughly dry all surfaces and removable parts before putting them back into place.

Although this appliance automatically defrosts, a layer of frost may occur on the freezer compartment's interior walls if the freezer door is opened frequently or kept open too long. If the frost is too thick, choose a time when the freezer is nearly empty and proceed as follow:

1. Remove existing food and accessories baskets, unplug the appliance from the mains power and leave the doors open. Ventilate the room thoroughly to accelerate the process.
2. When defrosting is completed, clean your freezer as described above.

Warning!

Do not use sharp objects to remove frost from the freezer compartment. Only after the interior is completely dry should the appliance be switched back on and plugged back into the mains socket.

### **Door seals cleaning**

Take care to keep door seals clean. Sticky food and drinks can cause seals to stick to the cabinet and tear when you open the door. Wash the seals with a mild detergent and warm water. Rinse and dry them thoroughly after cleaning. Warning! Only after the door seals are completely dry should the appliance be powered on.

### **Replacing the LED light**

**Warning:** The LED light must be replaced by a competent person. If the LED light is damaged, follow the steps below:

1. Unplug your appliance.
2. Remove light cover by rising up and pulling out the LED light.
3. Hold the LED light with one hand and pull it with the other hand while pressing the connector latch.
4. Replace LED light and snap it correctly in place and recover the light cover.



# TROUBLESHOOTING

---

If you experience a problem with your appliance or are concerned that the appliance is not functioning correctly, you can carry out some easy checks before calling for service, please see below. You can carry out some easy checks according to this section before calling for service.

**Warning!** Don't try to repair the appliance yourself. If the problem persists after you have made the checks mentioned below, contact a qualified electrician, authorized service engineer or the shop where you purchased the product.

| Problem:                           | Possible cause & Solution  |
|------------------------------------|--|
| Appliance is not working correctly | <ul style="list-style-type: none"><li>• Check whether the power cord is plugged into the power outlet properly.</li><li>• Check the fuse or circuit of your power supply, replace if necessary.</li><li>• The ambient temperature is too low. Try setting the chamber temperature to a colder level to solve this problem.</li><li>• It is normal that the freezer is not operating during the automatic defrost cycle, or for a short time after the appliance is switched on to protect the compressor.</li></ul>  |
| Odours from the compartments       | <ul style="list-style-type: none"><li>• The interior may need to be cleaned.</li><li>• Some food, containers or wrapping cause odours.</li></ul>   |
| Noise from the appliance           | <p>The sounds below are quite normal:</p> <ul style="list-style-type: none"><li>• Compressor running noises.</li><li>• Air movement noise from the small fan motor in the freezer compartment or other compartments.</li><li>• Gurgling sound similar to water boiling.</li><li>• Popping noise during automatic defrosting.</li><li>• Clicking noise before the compressor starts.</li></ul> <p>Other unusual noises are due to the reasons below and may need you to check and take action:</p> <ul style="list-style-type: none"><li>• The cabinet is not level.</li><li>• The back of appliance touches the wall.</li><li>• Bottles or containers knocking against each other.</li></ul> |

| Problem:                                   | Possible cause & Solution   |
|--|---|
| The motor runs continuously                | <p>It is normal to frequently hear the sound of the motor, it will need to run more during following circumstances:</p> <ul style="list-style-type: none"> <li>• Temperature setting is set colder than necessary.</li> <li>• Large quantity of warm food has recently been stored within the appliance.</li> <li>• The temperature outside the appliance is too high.</li> <li>• Doors are kept open too long or too often.</li> <li>• After your installing the appliance or it has been switched off for a long time.</li> </ul> |
| A layer of frost occurs in the compartment | <ul style="list-style-type: none"> <li>• Check that the air outlets are not blocked by food and ensure food is placed within the appliance to allow sufficient ventilation. Ensure the door can be fully closed. To remove the frost, please refer to the cleaning and care chapter..</li> </ul>  |
| Temperature inside is too warm             | <ul style="list-style-type: none"> <li>• You may have left the doors open too long or too frequently; or the doors are kept open by some obstacle; or the appliance is located with insufficient clearance at the sides, back and top.</li> </ul>   |
| Temperature inside is too cold             | <ul style="list-style-type: none"> <li>• Increase the temperature by following the "Display controls" chapter.</li> </ul>   |
| Doors can't be closed easily               | <ul style="list-style-type: none"> <li>• Check whether the top of the refrigerator is tilted back by 10-15mm to allow the doors to self close, or if something inside is preventing the doors from closing.</li> </ul>  |
| Water drips on the floor                   | <p>The water pan (located at the rear bottom of the cabinet) may not be properly leveled, or the draining spout underneath the top of the compressor depot may not be properly positioned to direct water into this pan, or the water spout is blocked. You may need to pull the refrigerator away from the wall to check the pan and spout. Check if the refrigerator is power-off for a long time, this may cause the ice in the bucket to melt into water, and flow to the floor..</p>   |
| The light is not working                   | <ul style="list-style-type: none"> <li>• The LED light may be damaged. Refer to replace LED lights in cleaning and care chapter.</li> <li>• The control system has disabled the lights due to the door being kept open too long, close and reopen the door to reactivate the lights.</li> </ul>   |

# DISPOSAL OF THE APPLIANCE

It is prohibited to dispose of this appliance as household waste.

## Packaging materials

Packaging materials with the recycle symbol are recyclable. Dispose of the packaging into a suitable waste collection container to recycle it.

## Before disposal of the appliance

1. Pull out the mains plug from the mains socket.
2. Cut off the power cord and discard with the mains plug

**Warning!** Refrigerators contain refrigerant and gases in the insulation. Refrigerant and gases must be disposed of professionally as they may cause eye injuries or ignition. Ensure that tubing of the refrigerant circuit is not damaged prior to proper disposal.

|  | CORRECT DISPOSAL OF THIS PRODUCT   |
|--|--|
|  | <p>The symbol on the product or its packaging indicates that the product should not be treated as normal household waste. The product should be taken to an authorized collection centre for waste electric and electronic equipment processing. Correct disposal of the product will help prevent any negative effects on the environment and health of people which could occur in case of incorrect product removal. For detailed information on removal and processing of the product, please contact the relevant municipal body in charge of waste management, your waste disposal service, or the store where you bought the product.</p> |

Gorenje, d.o.o.

Partizanska 12

SI - 3320 Velenje, Slovenija

info@gorenje.com

www.gorenje.com