

Simplicity

COLLECTION

BM235SYW

BM235SYB

DEAR CUSTOMER

We sincerely thank you for your purchase. We believe you will soon find ample evidence that you can really rely on our products. To make the use of the appliance easier, we attach these comprehensive instruction manual.

The instructions should aid you in getting familiar with your new appliance. Please, read them carefully before using the appliance for the first time.

In any case, please make sure the appliance was supplied to you undamaged. Should you identify and transport damage, contact your sales representative or the regional warehouse from where the product was delivered. You will find the telephone number on the receipt or delivery report.

We wish you a lot of pleasure with your new household appliance.



The appliance for household use for heating food and beverages using electromagnetic energy, for indoor use only.

INSTRUCTIONS FOR USE

These instructions are intended for the user. They describe the cooker and how to use it. They also apply to different types of appliances, therefore you may find some descriptions of functions that may not apply to your appliance.

We reserve the right to any changes and errors in the instructions for use.

IMPORTANT SAFETY INSTRUCTIONS



Never touch the surfaces of heating or cooking appliances. They will become hot during operation. Keep children at a safe distance. There is a risk of burning!



Microwave energy & High voltage!
Do not remove the cover.

WARNING! The appliance and its accessible parts become hot during use. Care should be taken to avoid touching heating elements. Children less than 8 years of age shall be kept away unless continuously supervised. Children should be supervised to ensure that they do not play with the appliance.

This appliance can be used by children aged from 8 years and above and persons with reduced physical, sensory or mental capabilities or lack of experience and knowledge if they have been given supervision or instruction concerning use of the appliance in a safe way and understand the hazards involved. Children shall not play with the appliance. Cleaning and maintenance shall not be made by children unless they are older than 8 and supervised.

Keep the appliance and its cord out of reach of children less than 8 years.

- **WARNING:** When the appliance is operated in the combination mode, children should only use the oven under adult supervision due to the temperatures generated; (Only for the model with grill function)

- **WARNING:** If the door or door seals are damaged, the oven must not be operated until it has been repaired by a competent person;
- **WARNING:** It is hazardous for anyone other than a competent person to carry out any service or repair operation that involves the removal of a cover which gives protection against exposure to microwave energy;
- **WARNING:** liquids and other foods must not be heated in sealed containers since they are liable to explode.
- Children should be supervised to ensure that they do not play with the appliance.
- Don't remove oven's feet, do not block air vents of the oven.
- Only use utensils that are suitable for use in microwave ovens.
- When heating food in plastic or paper containers, keep an eye on the oven due to the possibility of ignition;
- If smoke is observed, switch off or unplug the appliance and keep the door closed in order to stifle any flames;
- Microwave heating of beverages can result in delayed eruptive boiling, therefore care must be taken when handling the container;
- The contents of feeding bottles and baby food jars shall be stirred or shaken and the temperature checked before consumption, in order to avoid burns;
- Eggs in their shell and whole hard-boiled eggs should not be heated in microwave ovens since they may explode, even after microwave heating has ended;

- When cleaning surfaces of door, door seal, cavity of the oven, use only mild, nonabrasive soaps, or detergents applied with a sponge or soft cloth.
- The oven should be cleaned regularly and any food deposits removed;
- Failure to maintain the oven in a clean condition could lead to deterioration of the surface that could adversely affect the life of the appliance and possibly result in a hazardous situation;
- If the supply cord is damaged, it must be replaced by the manufacturer, its service agent or similarly qualified persons in order to avoid a hazard.
- Do not let the cord hang over the edge of the table or worktop.
- Never connect this appliance to an external timer switch or remote control system in order to avoid a hazardous situation.
- Never replace the light bulb inside the oven. It must always be replaced by Gorenje service.
- Do not clean the appliance with steam cleaners, high-pressure cleaners, sharp objects, abrasive cleaning agents, and abrasive sponges and stain removers.

SAFETY INSTRUCTIONS FOR GENERAL USE

Listed below are, as with all appliances, certain rules to follow and safeguards to assure top performance from this oven:

1. Always have the glass tray, roller arms, coupling and roller track in place when operating the oven.
2. Do not use the oven for any reason other than food preparation, such as for drying clothes, paper, or any other nonfood items, or for sterilizing purposes.
3. Do not operate the oven when empty. This could damage the oven.
4. Do not use the oven cavity for any type of storage, such as papers, cookbooks, etc.
5. Do not cook any food surrounded by a membrane, such as egg yolks, potatoes, chicken livers, etc without first being pierced several times with a fork.
6. Do not insert any object into the openings on the outer case.
7. Do not at any time remove parts from the oven such as the feet, coupling, screws, etc.
8. Do not cook food directly on the glass tray. Place food in/on proper cooking utensil before placing in the oven.

IMPORTANT - COOKWARE NOT TO USE IN YOUR MICROWAVE OVEN

- Do not use metal pans or dishes with metal handles.
 - Do not use anything with metal trim.
 - Do not use paper covered wire twist-ties on plastic bags.
 - Do not use melamine dishes as they contain a material which will absorb microwave energy. This may cause the dishes to crack or char and will slow down the cooking speed.
 - Do not use Centura Tableware. The glaze is not suitable for microwave use. Corelle Livingware closed handle cups should not be used.
 - Do not cook in a container with a restricted opening, such as a pop bottle or sealed oil bottle, as they may explode if heated in a microwave oven.
 - Do not use conventional meat or candy thermometers.
 - There are the thermometers available specifically for microwave cooking. These may be used.
9. Microwave utensils should be used only in accordance with manufacturer's instructions.
 10. Do not attempt to deep-fry foods in this oven.
 11. Please remember that a microwave oven only heats the liquid in a container rather than the container itself.

Therefore, even though the lid of a container is not hot to the touch when removed from the oven, please remember that the food/liquid inside will be releasing the same amount of steam and/or spitting when the lid is removed as in conventional cooking.

12. Always test the temperature of cooked food yourself especially if you are heating or cooking food/liquid for babies. It is advisable never to consume food/liquid straight from the oven but allow it to stand for a few minutes and stir food/liquid to distribute heat evenly.
13. Food containing a mixture of fat and water, e.g. stock, should stand for 30-60 seconds in the oven after it has been turned off. This is to allow the mixture to settle and to prevent bubbling when a spoon is placed in the food/liquid or a stock cube is added.
14. When preparing/cooking food/liquid and remember that there are certain foods, e.g. Christmas puddings, jam and mincemeat, which heat up very quickly. When heating or cooking foods with a high fat or sugar content do not use plastic containers.
15. Cooking utensil may become hot because of heat transferred from the heated food. This is especially true if plastic wrap has been covering the top and handles of the utensil. Potholders may be needed to handle the utensil.
16. To reduce the risk of fire in the oven cavity:
 - a) Do not overcook food. Carefully attend microwave oven if paper, plastic, or other combustible materials are placed inside the oven to facilitate cooking.
 - b) Remove wire twist-ties from bags before placing bag in oven.
 - c) If materials inside the oven should ignite, keep oven door closed, turn the oven off at the wall switch, or shut off power at the fuse or circuit breaker panel.

CONTROL PANEL

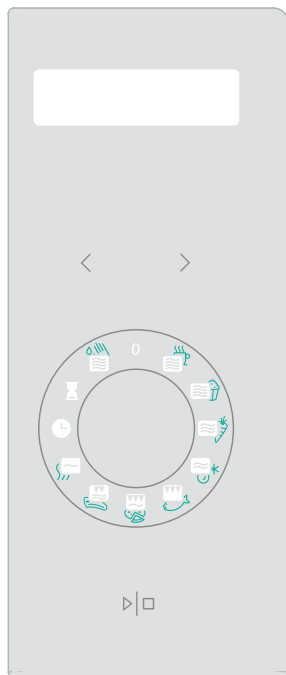

DISPLAY

(Cooking time, power, action indicators, and clock time are displayed.)



TIME

FUNCTION BUTTON SIMPLICITY



START | STOP

(Press once to start a cooking program. Press once to temporarily stop cooking. It is also used for setting child lock.)

BUTTON FOR DOOR OPENING

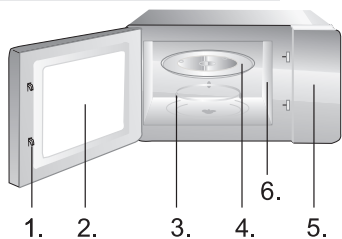

1. Door Safety Lock System
2. Oven Window
3. Roller Ring
4. Glass Tray
5. Control Panel
6. Wave guide (please do not remove the mica plate covering the wave guide)

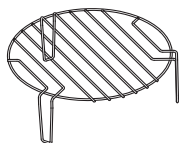

Grill rack (Only be used for grill or for combination function and be placed on glass tray)

INSTRUCTIONS FOR USE

1. CLOCK



The oven is fitted with a digital clock. When the oven is in the standby mode, the clock can be set in the 24-hour mode by pressing the CLOCK key.

For example: Suppose you want to set the oven clock time to 8:30.

1. In standby mode, turn the function knob to the CLOCK position.
2. Press < and > keys to set the time to 8:30.
3. Press button START | STOP once to confirm the hour setting.

2. DELAY START



This function allows you to program a cooking program to start at a later time.

For example: Suppose the present time is 9:00, and you want the oven to start a 5 minutes grill cooking program at 10:30.

1. Turn the function button to DELAY START.
2. Press < and > keys to set the time to 10:30.
3. Turn the function button to GRILL program in counter-clockwise direction.
4. Press the < or > directly to set the cooking time 5:00.
5. Press START | STOP to start.

NOTE:

When it is time to 10:30, the desired cooking program starts automatically.

3. CHILD LOCK



This function is used to prevent unsupervised operation of the oven by little children. The CHILD LOCK indicator will show up on display screen, and the oven can not be operated while the CHILD LOCK is set.

To set the CHILD LOCK: In standby mode of the oven, press button START | STOP and hold the button for 3 seconds, a beep sounds and lock indicator lights.

To cancel the CHILD LOCK: Press and hold the button START | STOP for 3 seconds until lock indicator on display turns off.

4. SELF CLEAN FUNCTION



Put in a glass of water – 200ml – and turn the function button to SELF CLEAN function. Press button START | STOP to start. After 8 minutes remove the glass and wipe the oven with dry cloth.

5. TIME ADJUSTMENT



To shorten or extend the operating time, select the appropriate function (microwave, grill...) and before confirmation adjust the time by pressing < or >.

6. SIMPLICITY KNOB USAGE























The Simplicity knob is used to set the desired function (cooking, defrost, grill, etc.). Icons on the button represent a typical food for this function, but are also applicable to other, similar types of food. On the next page, the table shows in detail the meaning and usage of individual functions and pre-set times of each function. These can of course be customized.

The function knob is also used to STOP or CANCEL the selected function – just turn it to the start position »0«.
Tips for using the oven

7. ECO MODE - POWER SAVING

Press the < and > keys simultaneously. The display will turn off and the microwave is in Eco mode which minimizes power usage.

To cancel the Eco mode and turn on the display again, press any other button or open or close the door.

Symbol	Function	Meaning	Quantity	Default time set	Hint
	Microwave 100% 	Cup of water / coffee /milk / tea	1 cup - 200ml	2 min 20 sec	For hotter drink or bigger cup increase time.
	Microwave 100% 	Pop-corn	1 bag - 100g	3 min 30 sec	For bigger bag increase time.
	Microwave 50% 	Vegetable	300g – carrots (sliced)	4 min	
	Microwave 30% 	Defrost	Bread 0,5kg	20 min	Decrease time for smaller pieces.
	Grill 85% 	Fish	Fish 500g	25 min	Turn fish after 12,5min, when signal beeps and press again START PAUSE.
	Microwave 30% + grill 70% 	Pizza	Pizza 350g	11 min	
	Microwave 40% + grill 60% 	Meat steak	Meat steak 500g	35 min	For crispier steak on both sides press START/PAUSE button 5 minutes before end, turn the steak and then press START/PAUSE again.
	Microwave 10% 	Staywarm		10 min	
	Clock	Clock			
	Delay start	Delay start			
	Microwave 100% 	Self - clean	1 cup - 200ml	5 min	

CARE OF YOUR MICROWAVE OVEN

1. Turn the oven off and remove the power plug from the wall socket before cleaning.
2. Keep the inside of the oven clean. When food splatters of spilled liquids adhere to oven walls, wipe with a damp cloth. The use of harsh detergent or abrasives is not recommended.
3. The outside oven surface should be cleaned with a damp cloth. To prevent damage to the operating parts inside the oven, water should not be allowed to seep into the ventilation openings.
4. Do not allow the Control Panel to become wet. Clean with a soft, damp cloth. Do not use detergents, abrasives or spray-on cleaners on the control Panel.
5. If steam accumulates inside or around the outside of the oven door, wipe with a soft cloth. This may occur when the microwave oven is operated under high humidity conditions and in no way indicates malfunction of the unit.
6. It is occasionally necessary to remove the glass tray for cleaning. Wash the tray in warm sudsy water or in a dishwasher.
7. The roller ring and oven cavity floor should be cleaned regularly to avoid excessive noise. Simply wipe the bottom surface of the oven with mild detergent, water or window cleaner and dry. The roller ring may be washed in mild sudsy water or dishwasher. Cooking vapours collect during repeated use but in no way affect the bottom surface or roller ring wheels. When removing the roller ring from cavity floor for cleaning, be sure to replace it in the proper position.
8. Remove odors from your oven by combining a cup of water with the juice and skin of one lemon in a deep microwavable bowl. Microwave for 5 minutes, wipe thoroughly and dry with a soft cloth.

ENVIRONMENT

Do not throw away the appliance with the normal household waste at the end of its life, but hand it in at an official collection point for recycling. By doing this, you help to preserve the environment.

MOUNTING THE MICROWAVE OVEN

INSTALLATION

1. Make sure all the packing materials are removed from the inside of the door.
2. Inspect the oven after unpacking for any visual damage such as:
 - Misaligned Door
 - Damaged Door
 - Dents or Holes in Door Window and Screen
 - Dents in Cavity

If any of the above are visible, DO NOT use the oven.

3. This Microwave Oven weighs 17,5 kg and must be placed on a horizontal surface strong enough to support this weight.
4. The oven must be placed away from high temperature and steam.
5. DO NOT place anything on top of the oven.
6. Keep the oven at least 20 cm away from both sidewalls and 30 cm away from rear wall to ensure the correct ventilation.
7. DO NOT remove the turn -table drive shaft.
8. As with any appliance, close supervision is necessary when used by children.
9. Make sure that the AC outlet is easily accessible so that the plug can be removed quickly in an emergency. Otherwise, it should be possible to disconnect the device using a switch from the circuit. In this case, the existing provisions of the electrical safety standards are considered.

The product has to be correctly installed on earthed socket with a single-phase AC (230 V/50 Hz).

WARNING! THIS APPLIANCE MUST BE EARTHED!

10. This oven requires 1.4 KVA for its input consultation with service engineer is suggested when installing the oven.

CAUTION: This oven is protected internally by a 250V, 10 Amp Fuse.

SPECIFICATIONS

Power consumption.....	220-240V-50Hz, 1400W
Output power	900W
Grill heater.....	1200W
Operating Frequency	2450MHz
Outside Dimensions.....	592mm(W) x 390mm(H) x 375mm(D)
Oven Capacity	23 litres
Uncrated Weight	Approx. 17,5 kg
Noise level.....	Lc < 58 dB (A)



This appliance is marked according to the European directive 2012/19/EU on Waste Electrical and Electronic Equipment (WEEE).

This guideline is the frame of a European-wide validity of return and recycling on Waste Electrical and Electronic Equipment.

MOUNTING DIMENSIONS

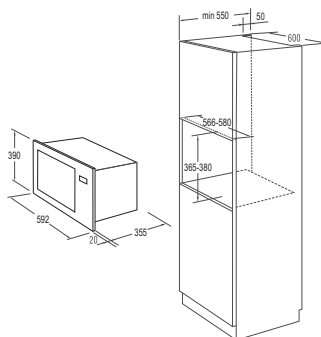

RADIO INTERFERENCE

Microwave oven may cause interference to your radio, TV, or similar equipment. When interference occurs, it may be eliminated or reduced by the following procedures.

- Clean the door and sealing surface of the oven.
- Place the radio, TV, etc. as far away from your microwave oven as possible.
- Use a properly installed antenna for your radio, TV, etc. to get a strong signal reception.

WE RESERVE THE RIGHT TO MAKE ANY CHANGES THAT DO NOT AFFECT THE FUNCTIONALITY OF THE APPLIANCE.

BEFORE YOU CALL FOR SERVICE

1. If the oven will not perform at all, the information on the display does not appear or the display disappeared:
 - a) Check to ensure that the oven is plugged in securely. If it is not, remove the plug from the outlet, wait 10 seconds and plug it in again securely.
 - b) Check the premises for a blown circuit fuse or a tripped main circuit breaker. If these seem to be operating properly, test the outlet with another appliance.
 2. If the microwave power will not function:
 - a) Check to see whether the timer is set.
 - b) Check to make sure that the door is securely closed to engage the safety interlocks. Otherwise, the microwave energy will not flow into the oven.
- If none of the above rectify the situation, then contact the nearest authorized service agent.**

The appliance for household use for heating food and beverages using electromagnetic energy, for indoor use only.

GUARANTEE & SERVICE

If you need information or if you have a problem, please contact the Gorenje Customer Care Centre in your country (you find its phone number in the worldwide guarantee leaflet). If there is no Customer Care Centre in your country, go to your local Gorenje dealer or contact the Service department of Gorenje domestic appliances.

Eventual mismatches in colour shades between different appliances or components within a single design line may occur due to various factors, such as different angles under which the appliances are observed, different coloured backgrounds, materials, and room illumination.

For personal use only!

Additional recommendations for cooking with microwave and useful advices can be found on web side:

<http://www.gorenje.com>

WISHES YOU A LOT OF PLEASURE WHILE USING YOUR APPLIANCE

gorenje

