

Contents

Your dishwasher	2	Troubleshooting	17
Safety instructions	3	Technical information	20
Before washing for the first time	4	Installation	21
Loading the dishwasher	5	Service	23
Using the dishwasher	9	Information for test institute	24
Settings	13	Your notes	25
Care and cleaning	15	Quick guide	28

Your dishwasher

Open the door and press the main power switch.

"Welcome to your ASKO. First time set-up." is shown on the display the first time the dishwasher is switched on. It is important that you choose the right settings to ensure good dishwashing results. See page 4.

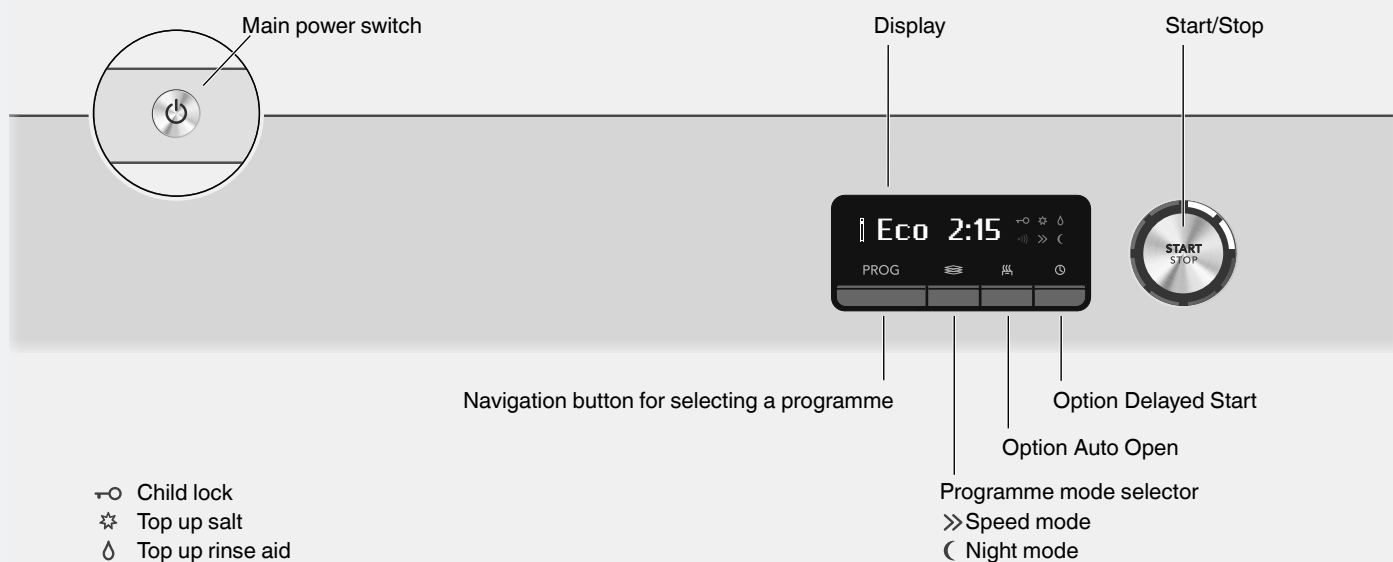

Safety instructions

- Read the operating instructions and keep them in a safe place!
- Number of standard place settings: 14
- Never use the dishwasher for any purpose other than that specified in these operating instructions.
- Do not load the dishwasher door or dishwasher baskets with anything other than dishes.
- Never leave the dishwasher door open as someone may trip on it.
- Use only dishwasher detergent!
- This machine can be used by children aged 8 and upwards, and by people with reduced physical capacity, mental ability, memory loss or lacking experience and knowledge. These individuals must be supervised when using the machine or have instructions on how to use the machine and understand the risks that can occur. Cleaning of the machine must not be carried out by children without supervision.
- Damaged mains cables must only be replaced by a qualified electrician.
- Only use the dishwasher in household-type environments for dishwashing household dishes. All other use is prohibited.
- Never place dishes with solvent residues in the dishwasher due to the risk of explosion. Nor may dishes that contain ash, wax or lubricants be washed in the dishwasher.
- Children must be watched. Do not allow children to use or play with the dishwasher. Be especially vigilant when the door is open. Some detergent may remain inside! After adding detergent, always start the dishwasher immediately.

WARNING!

Knives and other pointed items must be placed with the points down in the cutlery basket or horizontally in other baskets.

WARNING!

Children must be supervised – dishwasher detergent is corrosive!

Activate child lock (Kid Safe™)

You can activate the child lock (button lock) to prevent children from starting the dishwasher. See the chapter Settings.

Installation

See the chapter Installation.

Winter storage/Transport

Store the dishwasher above freezing and avoid long transport distances in very cold weather. Transport the dishwasher upright or laying on its back.

Overflow guard function

The overflow protection starts pumping out the machine and turns off the water supply if the water level in the dishwasher exceeds the normal level. If the overflow protection is triggered, turn off the water supply and call the service department.

Packing material

The packaging protects the product during transport. The packaging material is recyclable. Separate the different packaging materials to help reduce raw material use and waste. Your dealer can take the packaging for recycling or direct you to the nearest recycling centre. The packaging is comprised of:

- Corrugated cardboard made from up to 100% recycled material.
- Expanded polystyrene (EPS) with no added chlorine or fluorine.
- Supports made from untreated wood.
- Protective plastic made from polyethylene (PE).

Disposal

The dishwasher is manufactured and labelled for recycling.

When the dishwasher has reached the end of its service life and is to be disposed of, it should immediately be made unusable. Pull out the power cable and cut it as short as possible.

Contact your local authority for information about where and how your dishwasher should be correctly recycled.

Before washing for the first time

1. Checking water hardness

In order to achieve good dishwashing results, the dishwasher needs soft water (water with low mineral content). Hard water leaves a white coating on dishes and the dishwasher.

Water hardness is specified using the German water hardness scale (°dH) or the French water hardness scale (°fH).

A water supply with a water hardness in excess of 6°dH (9°fH) must be softened. This is done automatically with the aid of the built-in water softener. In order for the water softener to function optimally, it must be adjusted to the hardness of the water supply. Once you have adjusted the water softener, use detergent and rinse aid doses suitable for soft water.

Contact the local waterworks to check the water hardness in your area.

Make a note of the water hardness: _____

German water hardness scale	French water hardness scale	Recommended setting
0-5°dH	0-9°fH	0
6-8°dH	10-14°fH	1
9-11°dH	15-20°fH	2
12-14°dH	21-25°fH	3
15-19°dH	26-34°fH	4
22-24°dH	35-43°fH	5
25-29°dH	44-52°fH	6
30-39°dH	53-70°fH	7
40-49°dH	71-88°fH	8
50°dH	89°fH	9

If the water hardness exceeds 50°dH (89°fH), we recommend connecting an external water softener.

WARNING!

Hard water leaves a white coating on dishes and inside the dishwasher. It is therefore important that you select the right setting for the water softener! See Water hardness.

Never run the dishwasher with an empty salt compartment if the water supply has a water hardness in excess of 6°dH (9°fH).

2. Basic settings

Open the door and press the main power switch.

"Welcome to your ASKO. First time set-up." is shown on the display. It is important that you choose the right settings to ensure good dishwashing results.

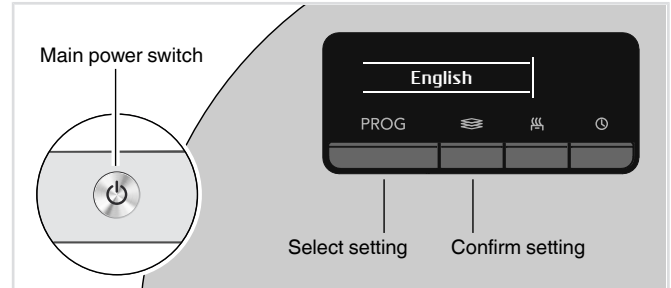

Settings

1. Language

Select the language to be shown on the display.

2. Set level of rinse aid 0/1/2/3/4/5/TAB

Drying is faster and a better result is achieved if you use rinse aid. You will also achieve a better dishwashing result with clear and spotless dishes.

Select rinse aid dosage. The rinse aid dispenser can be adjusted between 0 (Off) and 5 (High dosage).

When using an all-in-one detergent that contains rinse aid, you can activate the setting TAB. Read more about all-in-one detergent in the chapter Using the dishwasher.

Pre-selected at factory: 5

Top up rinse aid

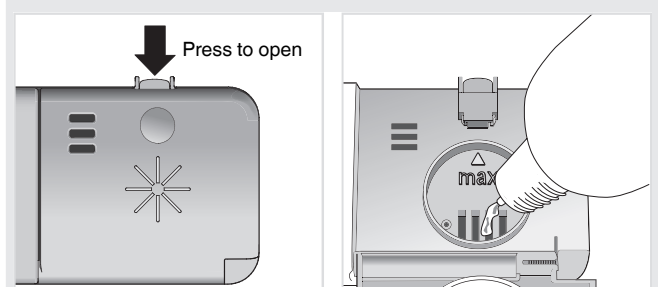

1. Open the rinse aid compartment lid.
2. Carefully top up with rinse aid to the level marked **max**.
3. Wipe up any splashes of rinse aid around the compartment.
4. Close the lid firmly.

Loading the dishwasher

3. Set water hardness 0/1/2/3/4/5/6/7/8/9

Adjusting the water softener. Select a setting depending on the hardness of the water supply. It is important that this setting is correct! Do not forget to put salt in the salt compartment after you have set the water softener to 1 - 9.

For a water supply with a hardness under 6°dH (9°fH), select 0. The water softener is deactivated and no salt is needed.

Pre-selected at factory: 4

✳ Top up salt

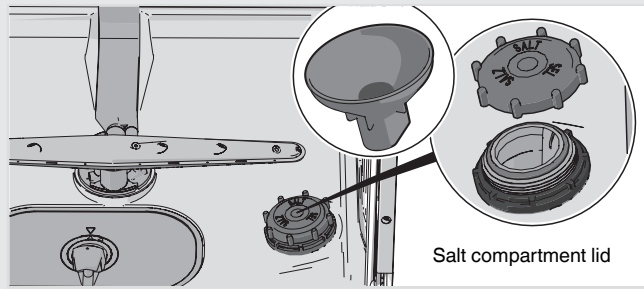

1. Unscrew the salt compartment lid.
2. Place the funnel supplied with the dishwasher in the salt compartment top-up hole. First, pour in about 1 l of water.
3. Then add salt, a maximum of 1.0 kg, until the compartment is full. Use large grain salt or special dishwasher salt.
4. Wipe up any excess salt so that the lid can be screwed on firmly.

In order to avoid rust stains a dishwashing programme must be started immediately after adding salt.

To change the selected setting, see the chapter Settings.

Greener dishwashing

Do not rinse under running water

Simply scrape off large food particles before loading the dishwasher.

Choose a green detergent

Read the environmental declaration on the packaging!

Run programmes only with a full load

Wait to run a programme until the dishwasher is full, this way you save energy. Use the Rinse & hold programme to rinse the dishes if there are any unpleasant odours while you wait for the dishwasher to become fully loaded.

Run programmes at a lower temperature

If the dishes are only slightly dirty, you can select a programme with a low temperature.

Select Eco

This programme is intended for cleaning normally dirty dishes and is the most effective programme in terms of combined energy and water consumption.

The dishwashing programme is designed for an effective wash using as little energy and water as possible. The programme washes at a low temperature for a long time.

Open the door a little once the programme has finished

A shorter dishwashing programme and better drying results are achieved if you use the Auto Open option, which automatically opens the dishwasher door. Wait until the dishwasher indicates that the programme has ended and the dishes have cooled before unloading the dishwasher.

Connect to cold water

Connect the dishwasher to the cold water supply if the building is heated using oil, electricity or gas.

Connection to hot water supply

Connect the dishwasher to the hot water supply (max. 70 °C) if the building is heated using an energy-efficient means such as district heating, solar power or geothermal power. Choosing a hot water connection cuts dishwashing times and reduces the dishwasher's energy consumption.

NOTE!

Do not exceed the permitted water supply temperature. Certain materials used in some cookware cannot withstand strong heat.

Fragile dishes

Some cookware is not dishwasher safe. This can be for several reasons. Some materials cannot withstand strong heat, others can be damaged by dishwashing detergent.

Exercise caution with, for example, handmade items, fragile decoration, crystal/glassware, silver, copper, tin, aluminium, wood and plastic. Look for the "Dishwasher safe" marking.

Fragile decoration

Porcelain with decoration on top of the glazing (the items feel rough) should not be washed in a dishwasher.

Crystal/Glass

Drying is faster and a better result is achieved if you use rinse aid. You will also achieve a better dishwashing result with clear and spotless dishes.

Hand-painted glassware, as well as antique and very fragile items, should not be washed in a dishwasher.

Silver

Silver and stainless steel items should not come into contact, as the silver can become discoloured.

Aluminium

Aluminium can lose its shine if washed in a dishwasher. However, good quality aluminium pans can be washed in a dishwasher, even if some of the shine will be lost.

Cutlery with glued handles

Some types of glue are not dishwasher safe. In such cases, the handles may loosen.

Points to consider

- All dirty surfaces should face inwards and downwards!
- Dishes should not be placed in or on each other.
- Angle dishes with hollows, such as cups, so that the rinse water will run off. This is also important for plastic items.
- Make sure small items cannot fall through the dishwasher basket; place them in the top cutlery tray.

NOTE!

Check that the spray arms can rotate freely.

The dishwasher's baskets

The dishwasher is equipped with a top cutlery tray, an upper basket and a lower basket with a cutlery basket.

The appearance of the baskets may differ depending on the dishwasher setup.

Top cutlery tray

The top cutlery tray has space for cutlery, ladles, whisks, serving cutlery and similar items.

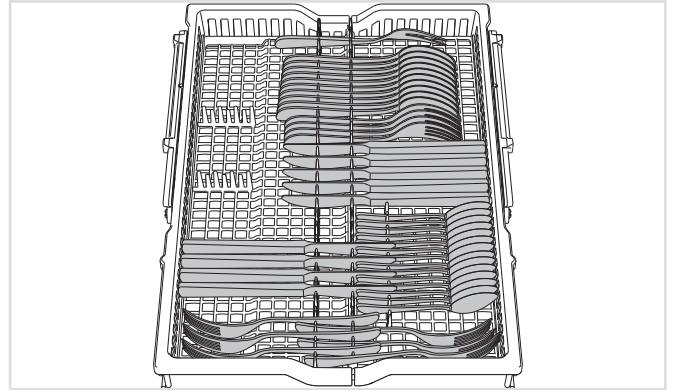

Raising the top cutlery tray

1. Pull out the top cutlery tray.
2. Pull forward the two locking handles on either side to raise the top cutlery tray.

Lowering the top cutlery tray

1. Make sure the upper basket is in the lowest position.
2. Pull out the top cutlery tray.
3. Slide the two locking handles on either side downwards and backwards to lower the top cutlery tray.

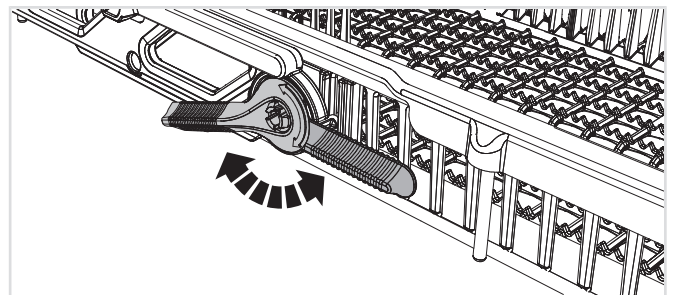

Upper basket

Place glasses, cups, bowls, side plates and saucers in the upper basket. All dirty surfaces should face inwards and downwards! Wine

glasses are placed on the wine glass shelf and knives are placed in the knife stand on the right.

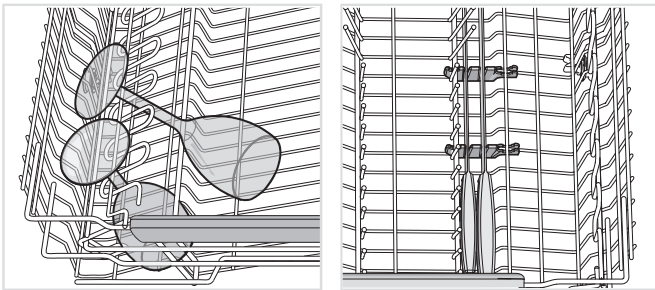
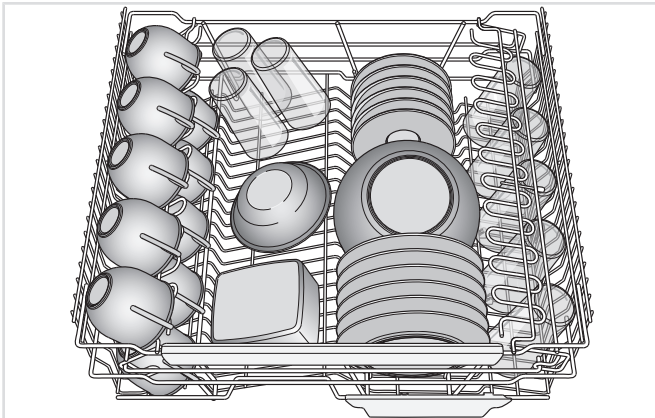

Raising the upper basket

1. Pull out the upper basket.
2. Grab the sides of the upper basket with both hands and lift it up.

Lowering the upper basket

1. Pull out the upper basket.
2. Pull out the two locking handles on either side to lower the upper basket.

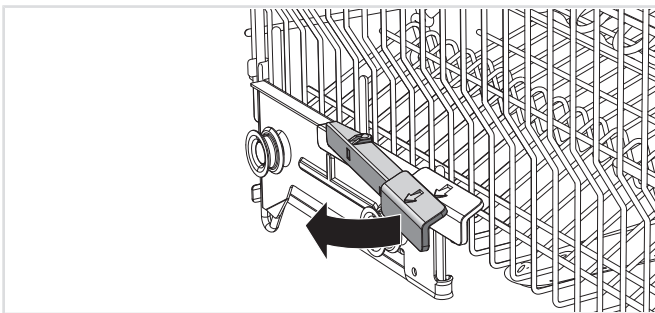

Lower basket

Place plates, side plates, serving dishes, pots and cutlery (in the cutlery basket) in the lower basket.

Place pots and pans in the rear right part of the lower basket to best utilise dishwashing performance from the rear of the two spray nozzles (WideSpray™), which are intended for these types of dishes.

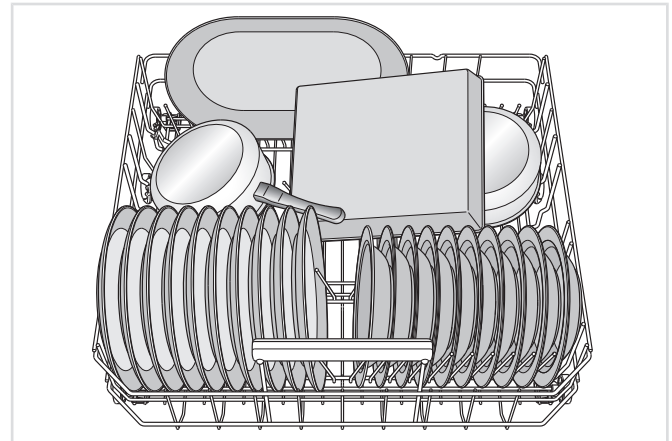

Foldable tines

Lower the foldable tines (plate supports) when washing pots. Release the foldable tines by pressing the catch inwards before adjusting their position.

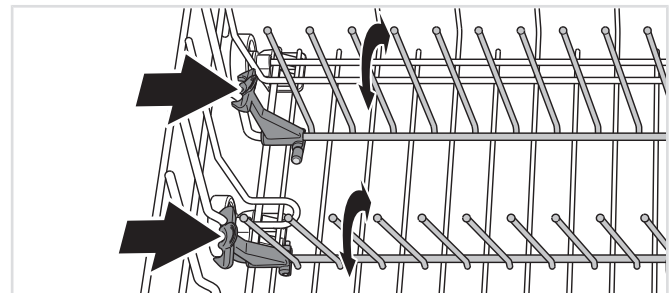

Washing large plates

Move foldable tines and their mounts to widen the distance between the tine rows to adapt the lower basket to plates with a diameter greater than 25 cm.

Accessory

Buy a wine glass shelf with space for six tall ¹⁾ wine glasses. The wine glass shelf is designed to ensure optimal washing and drying results with tall wine glasses. The wine glass shelf is placed in the rear section of the lower basket. This accessory is available where you bought the dishwasher.

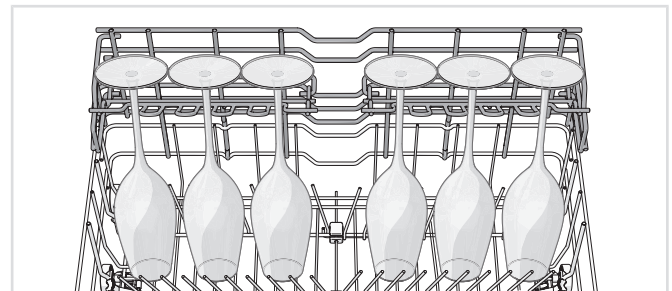

Cutlery basket

Place cutlery with the handles facing down, except for knives, and spread them out as much as possible. Ensure that spoons do not stack inside each other.

The cutlery basket is best placed in the middle at the front of the lower basket to best utilise dishwashing performance from the unique spray nozzle (Power Zone Cutlery™), which is intended for the cutlery basket.

! WARNING!

Knives and other pointed items must be placed with the points down in the cutlery basket or horizontally in other baskets.

¹⁾ Height: max. 25 cm, Diameter: max. 7.5 cm

Fold-down section for small items

The cutlery basket has a fold-down section in the middle for small items, or small shafts, such as electric whisk attachments.

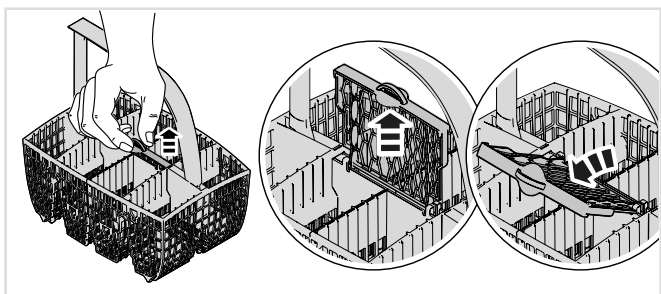

Accessory

Buy an extra cutlery basket. The extra cutlery basket is flexible and can be dismantled and attached to the lower basket or the large cutlery basket to make an extra large cutlery basket. This accessory is available where you bought the dishwasher.

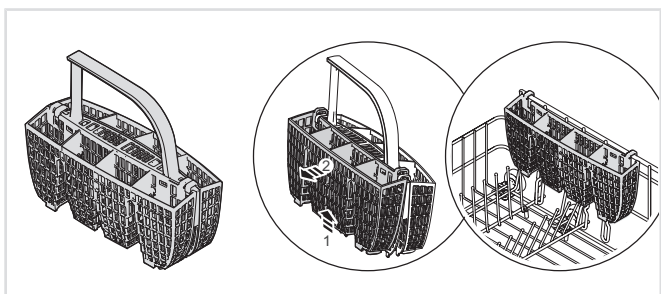

Using the dishwasher

Add detergent

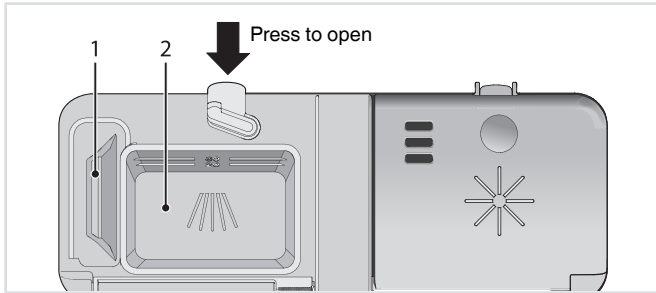

1. Prewash detergent compartment
2. Main wash detergent compartment

Detergent is added according to water hardness.

Follow the instructions on the detergent packaging. This dishwasher is fitted with a water softener, so use detergent and rinse aid doses suitable for soft water.

Too much detergent can result in less effective dishwashing and also entails greater environmental impact.

The detergent compartment must be dry when adding detergent. There is one compartment for the prewash and one for the main wash. If powder or liquid dishwasher detergent is used, add a small amount of the detergent to the prewash compartment. Contact the detergent manufacturer if you have questions about the detergent.

NOTE!

Use only dishwasher detergent! Washing up liquid must not be used as the foam that forms prevents the dishwasher from operating effectively.

Dishwasher tablets

Halve the tablet if it is difficult to close the dispenser lid. There is a risk that the detergent will not be released properly if the lid is tight and will not open correctly.

NOTE!

Dishwasher tablets are not recommended for short programmes (less than 75 minutes). Use powder or liquid dishwasher detergent instead.

All-in-one detergent

There are many types of all-in-one detergents on the market. Read through the directions for these products carefully.

When using an all-in-one detergent that contains rinse aid, you can activate the setting TAB. Note that the salt compartment must be filled with salt.

NOTE!

Optimal washing and drying results are achieved by using normal dishwasher detergent together with separately dispensed rinse aid and salt.

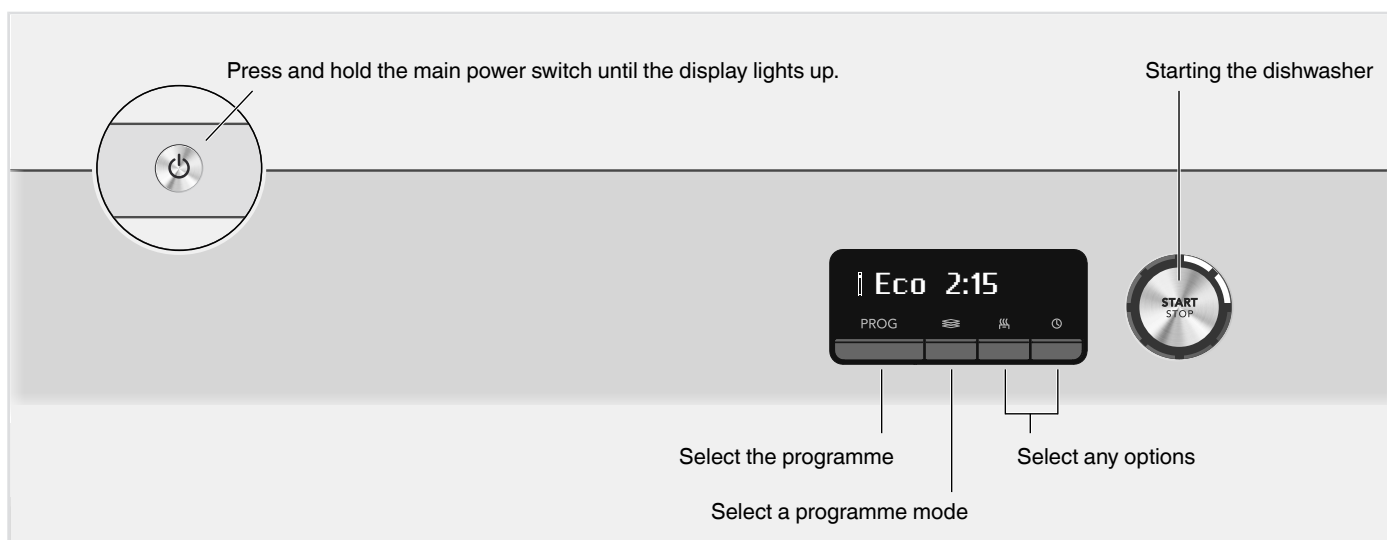

The main power switch

Open the door and press the main power switch. Close the door. Also turn on the water tap if it is turned off.

Select a programme

Eco is always pre-selected. To select another programme, press the navigation button **PROG** until the desired programme is shown on the display.

Select a programme to suit the type of dishes and how dirty they are.

Eco Eco

This programme is intended for cleaning normally dirty dishes and is the most effective programme in terms of combined energy and water consumption.

You can read more about greener dishwashing in the chapter Loading the dishwasher.

Aut Auto

The dishwasher can measure how dirty the dishes are and adjust water consumption and temperature accordingly. When newly installed, the programme needs to be run five times before it is fully adapted and can provide the best results.

Time program

The programme adapts to the specified running time or finish time. With this programme it is important to choose a time suited to how dirty the dishes are.

0:15-0:45	Slightly dirty dishes
1:00-1:30	Normally dirty dishes
2:00-2:30	Very dirty dishes

Press the  option button to set the desired programme time.

Rinse & hold

Used to rinse dishes while you wait for the dishwasher to become fully loaded.

Hyg Hygiene

This programme is ideal to use where demands on hygiene are extra high, e.g. for baby bottles and cutting boards. The temperature is high both in the main wash and in the final rinse.

Quick

A fast and powerful programme for daily use for slightly dried leftovers. (This programme is not intended for burnt food, such as on oven dishes.)

Intensive

Programme for very dirty dishes, such as pans, casserole dishes and oven dishes. If these dishes do not completely fill the dishwasher, you can add plates and the like.

Select a programme mode

To select a programme mode, press the programme mode selector until the desired mode is shown on the display. The available programme modes vary between programmes.

>> Speed mode

The programme time is shortened, but the dishwasher uses more energy.

(Night mode

Lower noise level during the dishwashing programme. The programme time is extended.

Select an option

To select an option, press the option button until the desired option is shown on the display. The available options vary between programmes.

Auto Open

The dishwasher door opens automatically, which shortens the programme time and improves the drying results. Wait until the dishwasher indicates that the programme has ended and the dishes have cooled before unloading the dishwasher.

NOTE!

The dishwasher door must not be blocked when set to open automatically. This can disrupt door lock functionality.

Delayed Start

When you select Delayed Start, the dishwasher will start 1-24 hours after you have pressed the button Start/Stop and closed the door.

1. Press the button once to activate Delayed Start. Press the button several times – or hold it in – to set the desired number of hours.
2. Press Start/Stop and close the door. The timer counts down and the dishwasher starts after the selected delay.

If you want to cancel the Delayed Start option, open the door then press and hold Start/Stop for three seconds.

START **STOP** Starting the dishwasher

Close the door properly, otherwise the dishwasher will not start. Press Start/Stop until the display shows "Program started".

If the dishwasher is not started within 2 minutes of the last button press, the machine switches off.

Time remaining

Once you have chosen a programme, programme mode and options, the time the programme took when last used is displayed.

Once you have started the dishwasher the display shows the remaining programme time. The remaining time is updated after the water for the final rinse has been heated.

This may differ somewhat from time to time depending on the temperature of the water supply, the amount of dishes, the ambient temperature and other factors.

During the first run of each programme, the remaining time displayed can be slightly misleading, as the dishwasher is estimating the time. When you run the programme a second time, the dishwasher will calculate the remaining time based on the previous duration of the programme.

Stopping or changing a programme

In order not to accidentally press a button and cancel the current programme, you must press and hold Start/Stop for five seconds if you want to change programmes after starting the dishwasher. Add more detergent if the lid of the detergent dispenser has opened. Then choose a new programme and press Start/Stop.

If you want to load more dishes

Open the door. The dishwasher stops automatically. Add the dishes and close the door. After a while, the dishwasher continues the programme.

If the dishwasher is turned off due to a power failure

If the dishwashing programme was not finished, the interrupted programme continues when power is restored.

NOTE!

During drying, the programme is interrupted if the power is cut or the door is open for more than 2 minutes.

Once the programme has finished

Once the programme has finished, "END" appears on the display.

At the end of the programme one short signal will sound. Chapter Settings describes how to change this function.

The dishwasher switches off automatically after the programme ends. Shut off the water tap after each use.

How to get the best drying results

- Fully load the dishwasher.
- Angle dishes with hollows, such as cups, so that the rinse water will run off. This is also important for plastic items.
- Top up with rinse aid or increase the rinse aid dosage level.
- Activate the Auto Open option.
- Activate the High temperature setting. See the chapter Settings.
- Activate the Extra Dry setting. See the chapter Settings.

- Allow the dishes to cool before unloading the dishwasher.

Unloading the dishwasher

Hot porcelain is more fragile. Leave the dishes to cool in the dishwasher before unloading them.

Unload the lower basket first to avoid any water drops from the upper basket falling onto the dishes in the lower basket.

Programme chart

Programme	Detergent, compartment 2 (ml)	Programme mode / Option	Prewashes	Main wash	Number of rinses	Final rinse	Consumption values ¹⁾						
							Cold water ²⁾			Hot water ³⁾			Water cons. (liter)
							Dishwashing time (approx. hrs:min)	Energy (approx. kWh)	Dishwashing time (approx. hrs:min)	Energy (approx. kWh)			
Eco Eco ⁴⁾	25	⏻ ⁵⁾	1	55 °C	2	48 °C	4:30	0.83	4:10	0.5	9.9		
Aut Auto	25		1-3	50-65 °C	2-3	65 °C	2:10-2:50	0.9-1.5	1:50-2:30	0.5-1.0	11-20		
🕒 Time program	25		0-2	<65 °C	2-3	<65 °C	0:15-2:30	0.5-1.6	0:15-2:30	0.4-1.2	11-19		
🚰 Rinse & hold					1	--- °C	0:07	0.01	0:07	0.01	3		
Hyg Hygiene	25			70 °C	2	70 °C	1:10	1.4	1:00	0.9	10		
👤 Quick	25	⏻ ⁵⁾	1	65 °C	3	65 °C	1:30	1.4	1:20	0.9	15		
🗑️ Intensive	25		2	70 °C	2	70 °C	2:55	1.7	2:35	1.3	14		

1) Consumption values vary depending on the temperature of the incoming water, room temperature, load size, selected additional functions and more.

2) Connection to cold water, approx. 15 °C.

3) Connection to hot water, approx. 60 °C.

4) This dishwashing programme is the standard cleaning cycle used to compile the energy labelling information. It is intended for washing normally dirty dishes and is the most effective programme in terms of combined energy and water consumption.

5) Auto Open

Settings

Open the dishwasher's Settings menu

To open the dishwasher's Settings menu, press the navigation button PROG until Settings menu is shown on the display and confirm your selection with the mode selector .

To exit the dishwasher's Settings menu, select Exit and confirm your selection with the mode selector .

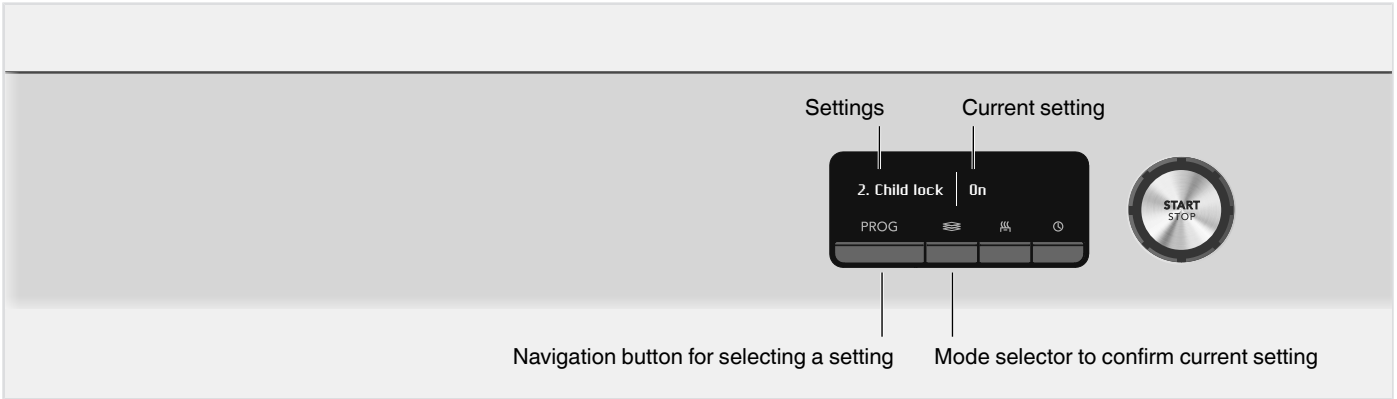

Settings	Options	
1. Language	<i>English/Svenska/Dansk/Norsk/Suomi/Nederlands/Français/Deutsch/Italiano/Русский/Español/Português/Sloven./Eesti/Latviešu/Lietuvių/Hrvatski/Polish/简体中文 / 繁體中文 / 日本語</i>	You can choose the language used for the display.
2. Child lock 	<i>On/Off</i>	You can activate the child lock (button lock) to prevent children from starting the dishwasher. To temporarily deactivate and activate the child lock, press and hold the mode selector  and the option button for Delayed Start  for 3 seconds.
3. Display	<i>Logotype On/Off</i>	Setting to hide the logo shown on the display.
	<i>Contrast 1/2/3/4</i>	For adjusting the contrast of the display.
	<i>Prog. info screen T/S</i>	You can select which information is shown on the display. T-Text (Text) S-Symbol (Symbol)  
4. Sound	<i>Feedback 0/1/2/3</i>	This sound is used to confirm each button press.
	<i>Volume 0/1/2/3</i>	The buzzer indicates when a dishwashing programme has ended. <i>Error messages are always indicated by a loud buzzer.</i>
5. Rinse aid 	<i>0/1/2/3/4/5/TAB</i>	Setting for rinse aid dosage. The rinse aid dispenser can be adjusted between 0 (Off) and 5 (High dosage). Increase the rinse aid dosage: <ul style="list-style-type: none"> • If the dishes have water marks. Decrease the rinse aid dosage: <ul style="list-style-type: none"> • If the dishes have a sticky white/blue film. • If the dishes are streaked. • Build-up of foam. If you have very soft water, the rinse aid can be diluted 50:50 with water. When using an all-in-one detergent that contains rinse aid, you can activate the setting TAB.
6. Super rinse	<i>On/Off</i>	Super rinse adds two extra rinses. <i>Activated in the following programmes:</i> <i>Intensive</i>

Settings	Options																																		
7. High temperature	<i>On/Off</i>	Activate the setting High temperature to improve the dishwashing results. Energy consumption is slightly increased. <i>Activated in the following programmes:</i> <i>Intensive</i>																																	
8. Extra Dry	<i>On/Off</i>	Activate the setting Extra Dry to improve the drying results. Energy consumption is slightly increased. <i>Activated in the following programmes:</i> <i>Eco</i> <i>Auto</i> <i>Quick</i> <i>Intensive</i>																																	
9. Water hardness	<i>0/1/2/3/4/5/6/7/8/9</i>	Adjusting the water softener. Select a setting depending on the hardness of the water supply. It is important that this setting is correct! <table border="1" data-bbox="879 745 1477 1261"> <thead> <tr> <th data-bbox="885 754 1075 808">German water hardness scale</th> <th data-bbox="1082 754 1246 808">French water hardness scale</th> <th data-bbox="1252 754 1471 808">Recommended setting</th> </tr> </thead> <tbody> <tr> <td data-bbox="885 817 1075 853">0-5°dH</td> <td data-bbox="1082 817 1246 853">0-9°fH</td> <td data-bbox="1252 817 1471 853">0</td> </tr> <tr> <td data-bbox="885 862 1075 898">6-8°dH</td> <td data-bbox="1082 862 1246 898">10-14°fH</td> <td data-bbox="1252 862 1471 898">1</td> </tr> <tr> <td data-bbox="885 907 1075 943">9-11°dH</td> <td data-bbox="1082 907 1246 943">15-20°fH</td> <td data-bbox="1252 907 1471 943">2</td> </tr> <tr> <td data-bbox="885 952 1075 987">12-14°dH</td> <td data-bbox="1082 952 1246 987">21-25°fH</td> <td data-bbox="1252 952 1471 987">3</td> </tr> <tr> <td data-bbox="885 996 1075 1032">15-19°dH</td> <td data-bbox="1082 996 1246 1032">26-34°fH</td> <td data-bbox="1252 996 1471 1032">4</td> </tr> <tr> <td data-bbox="885 1041 1075 1077">22-24°dH</td> <td data-bbox="1082 1041 1246 1077">35-43°fH</td> <td data-bbox="1252 1041 1471 1077">5</td> </tr> <tr> <td data-bbox="885 1086 1075 1122">25-29°dH</td> <td data-bbox="1082 1086 1246 1122">44-52°fH</td> <td data-bbox="1252 1086 1471 1122">6</td> </tr> <tr> <td data-bbox="885 1131 1075 1167">30-39°dH</td> <td data-bbox="1082 1131 1246 1167">53-70°fH</td> <td data-bbox="1252 1131 1471 1167">7</td> </tr> <tr> <td data-bbox="885 1176 1075 1211">40-49°dH</td> <td data-bbox="1082 1176 1246 1211">71-88°fH</td> <td data-bbox="1252 1176 1471 1211">8</td> </tr> <tr> <td data-bbox="885 1220 1075 1256">50°dH</td> <td data-bbox="1082 1220 1246 1256">89°fH</td> <td data-bbox="1252 1220 1471 1256">9</td> </tr> </tbody> </table> <p data-bbox="871 1301 1477 1355">Do not forget to put salt in the salt compartment after you have set the water softener to 1 - 9.</p> <p data-bbox="871 1357 1477 1406"><i>For a water supply with a hardness under 6°dH (9°fH), select 0. The water softener is deactivated and no salt is needed.</i></p>	German water hardness scale	French water hardness scale	Recommended setting	0-5°dH	0-9°fH	0	6-8°dH	10-14°fH	1	9-11°dH	15-20°fH	2	12-14°dH	21-25°fH	3	15-19°dH	26-34°fH	4	22-24°dH	35-43°fH	5	25-29°dH	44-52°fH	6	30-39°dH	53-70°fH	7	40-49°dH	71-88°fH	8	50°dH	89°fH	9
German water hardness scale	French water hardness scale	Recommended setting																																	
0-5°dH	0-9°fH	0																																	
6-8°dH	10-14°fH	1																																	
9-11°dH	15-20°fH	2																																	
12-14°dH	21-25°fH	3																																	
15-19°dH	26-34°fH	4																																	
22-24°dH	35-43°fH	5																																	
25-29°dH	44-52°fH	6																																	
30-39°dH	53-70°fH	7																																	
40-49°dH	71-88°fH	8																																	
50°dH	89°fH	9																																	
Exit		To exit the dishwasher's Settings menu, select Exit and confirm your selection with the mode selector  .																																	

Care and cleaning

💧 Top up rinse aid

When the rinse aid needs topping up, the above symbol lights on the display.

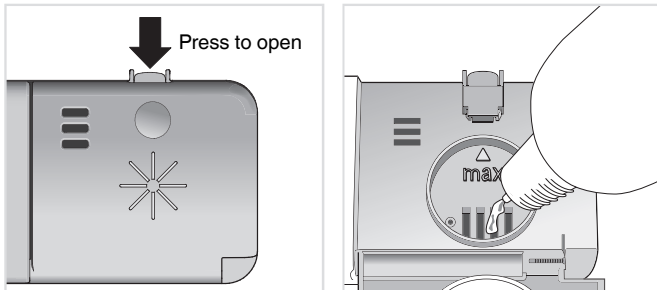

1. Open the rinse aid compartment lid.
2. Carefully top up with rinse aid to the level marked **max**.
3. Wipe up any splashes of rinse aid around the compartment.
4. Close the lid firmly.

After topping up, it may take a while before the symbol goes out.

★ Top up salt

When the salt needs topping up, the above symbol lights on the display.

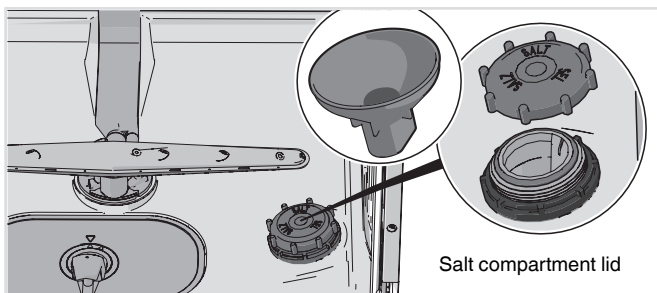

When the salt runs out, unscrew the cap and fill the container with salt. Water is only needed the first time! Wipe clean and tighten. Run a programme to ensure that any salt in the dishwasher is rinsed away.

After topping up, it may take a while before the symbol goes out.

⚠️ WARNING!

In order to avoid rust stains a dishwashing programme must be started immediately after adding salt.

Never pour dishwasher detergent into the salt compartment. This destroys the water softener!

Coarse filter

The coarse filter traps larger food particles, which cannot get past the drainage pump. Empty the coarse filter when necessary.

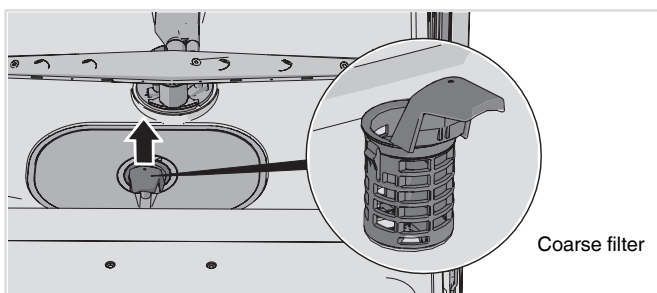

1. Lift the coarse filter by the handle.
2. Empty the coarse filter. Remember to refit it!

Fine filter

Debris that collects on the fine filter is automatically rinsed away during each wash. Clean the fine filter when necessary.

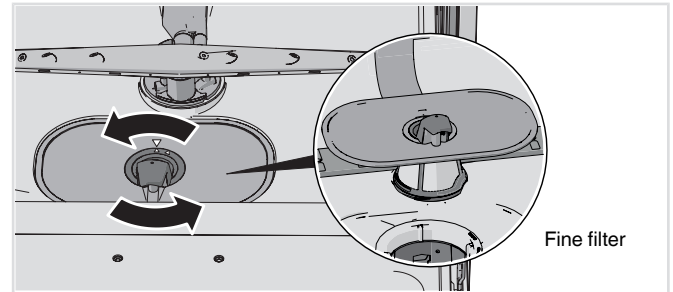

1. Turn the handle anticlockwise.
2. Lift the filter straight up using the handle. Free the coarse filter to clean the fine filter.
3. Refit in reverse order. Check that the edges seal properly when refitting the fine filter.
4. Lock the filter in place by turning the handle clockwise to the stop position. The handle should point straight out from the dishwasher.

NOTE!

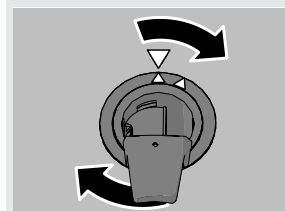

Dishwashing results may be affected if the filters are incorrectly fitted. Note that the dishwasher must not be used without the filters in place!

NOTE!

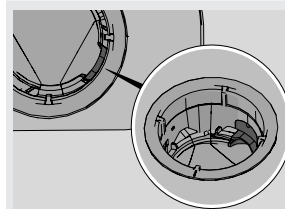

Check that the coloured stop on the right in the bottom drain is in place.

Spray arms

Holes and bearings can sometimes become blocked. Remove any debris using a pin or the like. The spray arms also have holes underneath.

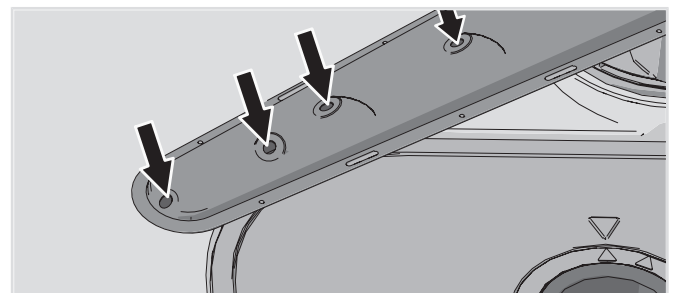

To facilitate cleaning you can remove the spray arms. Remember to fit them firmly back into place afterwards.

Top spray arm

- The upper basket must be removed before the top spray arm can be released. Pull out the upper basket and turn the basket catch on each runner outwards (see illustration). The basket can now be removed.

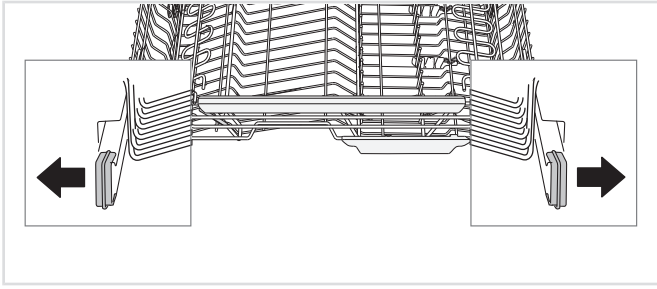

- Pull out the top cutlery tray. Press the top spray arm up and unscrew the spray arm bearings counterclockwise to remove the spray arm.

Upper spray arm

1. Pull out the upper basket.
2. Unscrew the spray arm bearings counterclockwise to remove the spray arm from the upper basket.

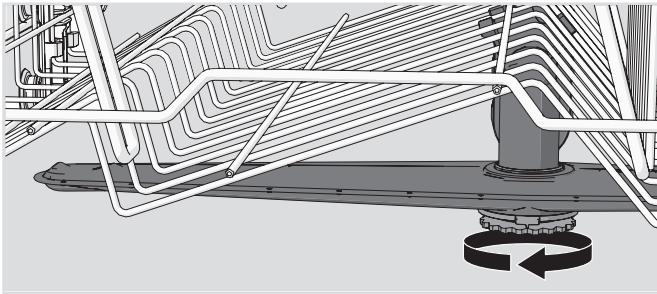

Lower spray arm

- Pull the lower spray arm straight up to release it.

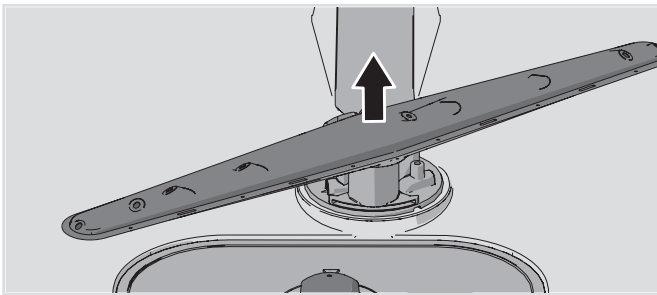

The door and the door seal

Regularly clean the sides of the door and the door seal. Use a slightly damp cloth (with a little cleaner if necessary).

Front panel

Keep the buttons clean and free from grease. Wipe them clean with a dry or slightly damp cloth. Never use cleaners – they can scratch the surface. Use the main power switch to turn off the dishwasher before cleaning the buttons to avoid activating any buttons unintentionally.

The dishwasher tub

The dishwasher tub is made of stainless steel and is kept clean through normal use.

Limescale deposits

If you have hard water, limescale deposits may build up in the dishwasher. If this happens, run the Intensive programme with two tablespoons of citric acid in the detergent compartment (with no dishes in the machine). Special dishwasher cleaners are also available on the market.

Unblocking the drainage pump

If the dishwasher still contains water after the programme has finished, something may be blocking the drainage pump. Such items are easily removed.

1. Turn off the machine using the main power switch and unplug it from the wall socket.
2. Remove the coarse filter and the fine filter.
3. Scoop out the water from the dishwasher tub.
4. In order to inspect the drainage pump, remove the coloured stop on the right in the bottom drain.
5. Turn the pump wheel located behind the drainage pump stop by hand. Carefully remove any items.
6. Refit the drainage pump stop along with the fine and coarse filters.
7. Plug the machine in again.

If the dishwasher still does not start and a whirring sound is heard, the overflow protection has been activated.

- Shut off the water.
- Remove the plug from the wall socket.
- Call the service department.

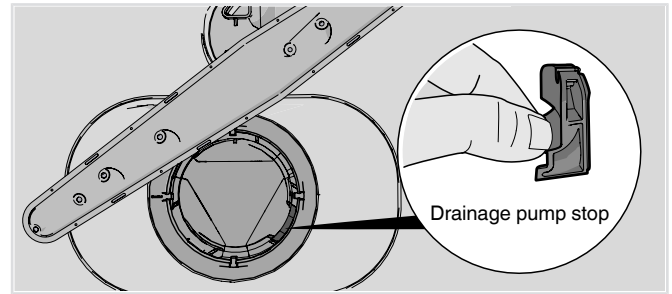

NOTE!

Do not forget to refit the drainage pump stop.

Unblocking the inlet hose filter

If the water supply contains small particles, the outer filter on the inlet hose may become blocked, which results in Water inlet fault.

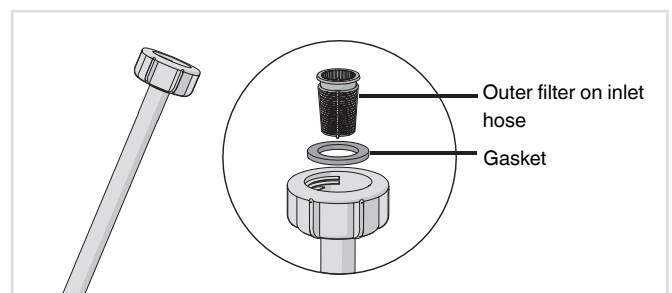

1. Turn off the machine using the main power switch and unplug it from the wall socket.
2. Turn off the water tap.
3. Unscrew the inlet hose.
4. Carefully remove the outer filter from the inlet hose and clean it.
5. Refit the filter and check that the gasket is correctly positioned.
6. Screw the inlet hose firmly into place.
7. Plug the machine into the wall socket and turn on the water tap. Allow the pressure to settle for a while and check that the connection is watertight.



Troubleshooting

Type of fault on the display		Action
F10	Overfilling water 1	Clear the drainage pump. See the chapter Care and cleaning. If the problem persists, call the service department.
F11	Water outlet fault	See "Water remains in the dishwasher" in the table "Problem" below. If the problem persists, call the service department.
F12	Water inlet fault	Check that the water tap is on. Check that the outer filter on the inlet hose is not blocked. See Unblocking the inlet hose filter in the chapter Care and cleaning. If the problem persists, call the service department.
F40	Inlet valve leakage	Turn off the water tap and call the service department.
F52	Water level fault	Clean the coarse and fine filters. Check that the outer filter on the inlet hose is not blocked. If the problem persists, call the service department.
F54	Overfilling water 2	Turn off the water tap and call the service department.
F56	Circ. pump fault	Call the service department.

Press any button to clear the error message.

Problem	Possible causes	Action
Pressing the main power switch has no effect.	The door is closed.	Open the door. The main power switch only works when the door is open.
The buttons do not react when pressed.	You have pressed the buttons too soon after opening the door.	Wait a moment then try again.
	Child lock (button lock) activated.	See the chapter Settings.
	The buttons are dirty.	Clean with a dry or slightly damp cloth.
Cannot close door.	The baskets are not correctly positioned.	Check that the baskets are correctly positioned horizontally. Check that the dishes are not blocking the baskets from sliding properly into place.
	The door lock does not click into place and lock.	Check the door lock. If it does not click into place and lock, open the door. Press and hold the navigation button PROG and the option button Auto Open  for five seconds. Then wait 30 seconds. Close the door. Check that the door lock clicks into place and locks.
The dishwasher does not start.	The Start/Stop start button has been pressed for too short a time.	Press and hold Start/Stop until the display shows "Program started".
	The door is not properly closed.	Check.
	You have opened the dishwasher to add more dishes while a programme is in progress.	Close the door and wait. After a while, the dishwasher continues the programme.
	The door lock has not clicked into place and locked.	Check the door lock. If it has not clicked into place and locked, open the door. Press and hold the navigation button PROG and the option button Auto Open  for five seconds. Then wait 30 seconds. Close the door. Check that the door lock clicks into place and locks and that the dishwasher starts.
	A fuse/circuit breaker has been tripped.	Check.
	The plug is not plugged into the wall socket.	Check.
	The water tap is turned off.	Check.
	Overflow/leaks.	Check.
	A whirring sound (the drainage pump) is heard from the dishwasher and does not stop when the main power switch is turned off.	Turn off the water tap. Pull out the plug and call the service department.
	Check that the Delayed Start option has not been selected.	Press and hold Start/Stop for three seconds if you want to cancel the Delayed Start option.

Problem	Possible causes	Action
The dishes are not clean.	The spray arms do not rotate.	Check that the dishes are not blocking the spray arms.
	Spray arm holes or bearings blocked.	Clean the spray arms. See the chapter Care and cleaning.
	Unsuitable dishwashing programme.	Choose a longer programme.
	Incorrect detergent dosage.	Dose according to water hardness. Far too much or far too little detergent results in poorer dishwashing results.
	Old detergent. Detergent is a perishable product.	Avoid large packages.
	Dishes loaded incorrectly.	Do not cover porcelain with large bowls or the like. Avoid placing very tall glasses in the corners of the baskets.
	Glasses and cups have toppled over during the programme.	Place dishes to sit steady.
	The filters are not fitted correctly.	Check that the filter handle is locked in the stop position. The handle should point straight out from the dishwasher.
Spots on stainless steel or silver.	Drainage pump stop missing.	Check that the coloured stop on the right in the bottom drain is in place. See the chapter Care and cleaning.
	Some foodstuffs, such as mustard, mayonnaise, lemon, vinegar, salt and dressings, can mark stainless steel if left for too long.	Rinse off these types of foodstuffs if not starting the dishwasher immediately. Use the Rinse & hold programme.
Spots or films on the dishes.	All stainless steel can cause spots on silver if they come into contact during dishwashing. Aluminium can also cause spots on dishes.	In order to avoid marks and tarnishing, separate dishes made from different metals, such as silver, stainless steel and aluminium.
	Incorrect rinse aid dosage setting.	See the chapter Settings.
	The setting TAB is activated and all-in-one detergent with insufficient drying effect is being used.	Switch all-in-one detergents or deactivate the setting TAB and top up with salt and separate rinse aid. See Rinse aid in the chapter Settings.
	Salt compartment empty.	Top up with salt. See the chapter Care and cleaning.
	Incorrect water softener setting.	See Water hardness in the chapter Settings.
	The water softener is leaking salt.	Check that the salt compartment lid is properly tightened. Otherwise call the service department.
The dishes have a sticky white/blue film.	Too high temperature and/or too much detergent can cause etching on crystal. Unfortunately, this cannot be repaired, only prevented.	Wash crystal at a low temperature and with a conservative amount of detergent. Contact the detergent manufacturer.
	Rinse aid dosage setting too high.	Reduce the dosage. See the chapter Settings. If you have very soft water, you may want to dilute the rinse aid 50:50 with water.
Spots left after washing.	Lipstick and tea can be difficult to wash off.	Use a detergent with a bleaching agent.
Detergent residue in the detergent compartment after dishwashing.	The detergent compartment was damp when adding detergent.	The detergent compartment must be dry when adding detergent.
	The detergent compartment has been blocked.	Check that the dishes are not preventing the detergent compartment from opening.
Rattling sound when dishwashing.	The dishes are not correctly placed or the spray arms are not rotating.	Check that the dishes are placed securely. Spin the spray arms to make sure they can rotate.
1 minute appears in the display.	The programme is taking longer than estimated.	No action. The programme time is stored and next time the programme is run the corrected time will be displayed.

Problem	Possible causes	Action
Water remains in the dishwasher.	The filters are blocked.	Clean the coarse and fine filters.
	The filters are not fitted correctly.	Check that the filter handle is locked in the stop position. The handle should point straight out from the dishwasher.
	Debris in the drainage pump.	Clean the drainage pump. See the chapter Care and cleaning.
	Drainage pump stop missing.	Check that the coloured stop on the right in the bottom drain is in place. See the chapter Care and cleaning.
	Kink in drainage hose.	Check that the hose is free from kinks and sharp bends.
	Blocked drainage hose.	Disconnect the drainage hose where it connects to the sink unit's water trap. Check that no debris has fastened and that the connection has an inner diameter of at least 14 mm.
Bad odour in dishwasher.	Dirt around the seals and in corners.	Clean with washing-up brush and low foaming cleaner.
	Low temperature programmes have been selected for a prolonged period.	Run a programme with a higher temperature once or twice a month.
The dishes are not dry enough.	The Auto Open option is not activated.	Activate the Auto Open option.
	The dishwasher is not fully loaded.	Fully load the dishwasher.
	Rinse aid needs topping up or dosage is set too low.	Top up with rinse aid or increase the rinse aid dosage level. See the chapter Settings.
	The setting TAB is activated and all-in-one detergent with insufficient drying effect is being used.	Switch all-in-one detergents or deactivate the setting TAB and top up with salt and separate rinse aid. See Rinse aid in the chapter Settings.

Technical information

Information on energy labelling

Information sheet, in compliance with Commission Delegated Regulation (EU) No. 1059/2010

ASKO

Model designation:	DFS244IB
Number of standard place settings:	14 ¹⁾
Energy efficiency class:	A+++
Annual energy consumption(AE _C):	237 kWh per year ²⁾
Energy consumption of the standard cleaning cycle(E _c):	0.83 kWh
Power consumption	
Off-mode (P _o):	0.49 W
Left-on mode (P _l):	0.49 W
Annual water consumption (AW _C):	2772 litres per year ³⁾
Drying efficiency class:	A ⁴⁾
Standard programme:	Eco ⁵⁾ , option Auto Open
Programme time for the standard cleaning cycle:	270 minutes
Duration of the left-on mode (T _l):	Infinite
Noise emissions:	42 dB(A) re 1 pW

1) *In accordance with standard, EN 50242.*

2) *Based on 280 standard cleaning cycles with a cold water connection and consumption in accordance with energy saving mode. The actual energy consumption depends on how the machine is used.*

3) *Based on 280 standard cleaning cycles. The actual water consumption depends on how the machine is used.*

4) *On a scale from G (least efficient) to A (most efficient).*

5) *This dishwashing programme is the standard cleaning cycle used to compile the energy labelling information. It is intended for washing normally dirty dishes and is the most effective programme in terms of combined energy and water consumption.*

Technical data

Height:	861-881 mm
Width:	600 mm
Depth:	596 mm
Weight:	70 kg ¹⁾
Water pressure:	0.03–1.0 MPa
Electrical connection:	See serial number plate
Rated power:	See serial number plate

1) *Weight can vary due to different specifications.*

Installation

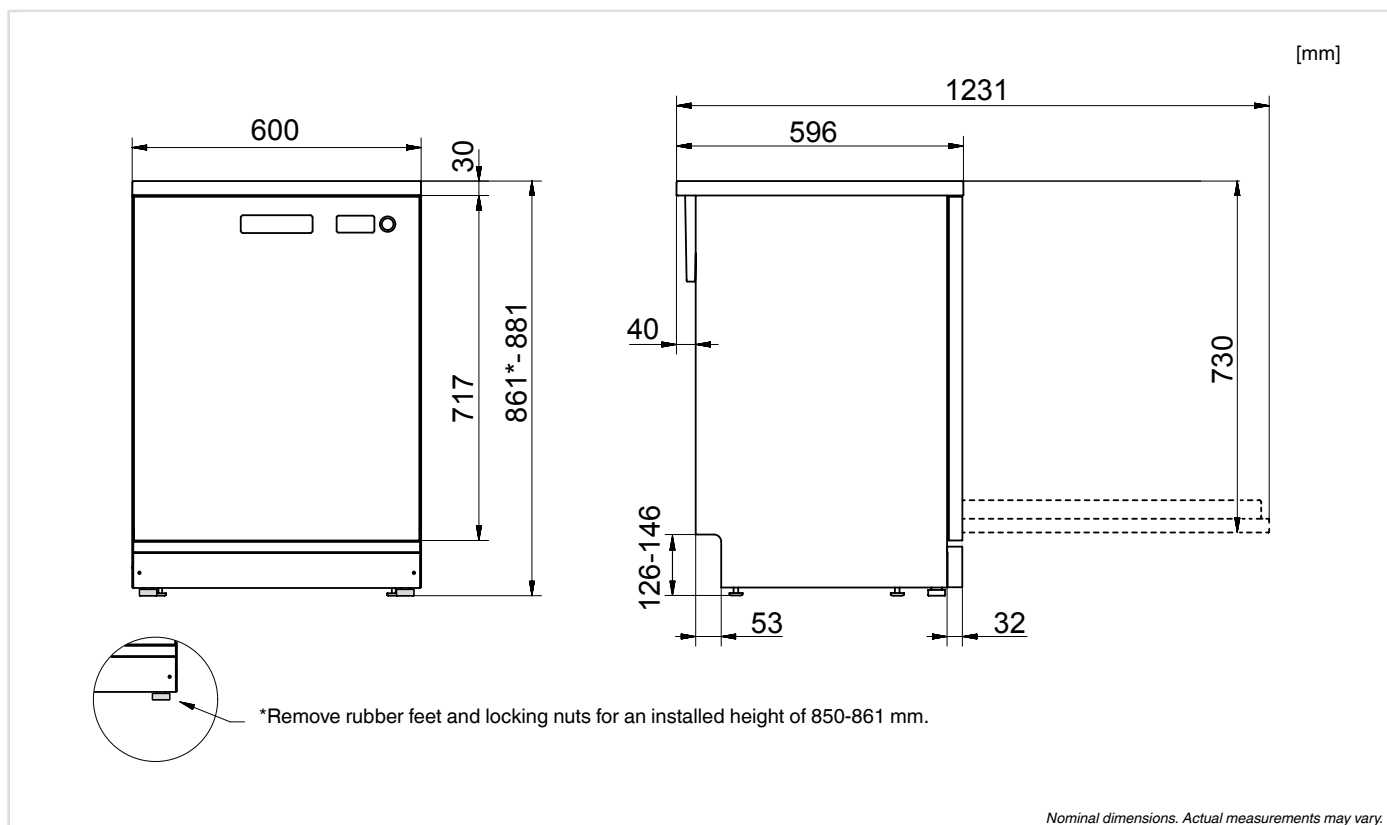

Safety instructions

- Connections to electricity, water and drainage must be performed by a qualified professional.
- Always follow applicable regulations for water, drainage and electricity.
- Take care during installation! Wear protective gloves! There must always be two people!
- Place a drip tray on the floor beneath the dishwasher to prevent damage from any water leaks.
- Before screwing the dishwasher into place, test the dishwasher by running the Rinse & hold programme. Check that the dishwasher fills with water and drains. Check also that none of the connections leak.

WARNING!

Turn off the water supply when installing the dishwasher!

The plug must be disconnected or power to the socket turned off while the work is carried out!

Transport protection for the door

Do not forget to remove the transport protection for the door when unpacking the dishwasher.

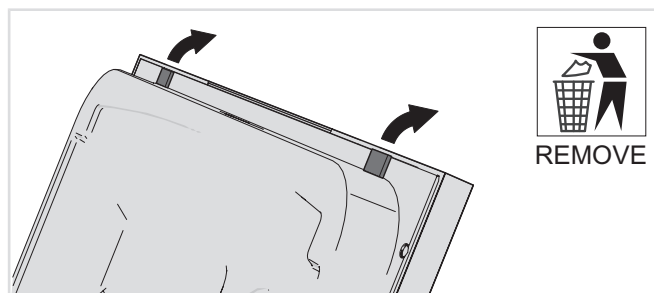

Placing the dishwasher

The dishwasher can be installed under a worktop or freestanding.

Adjust the height and slide the dishwasher into place

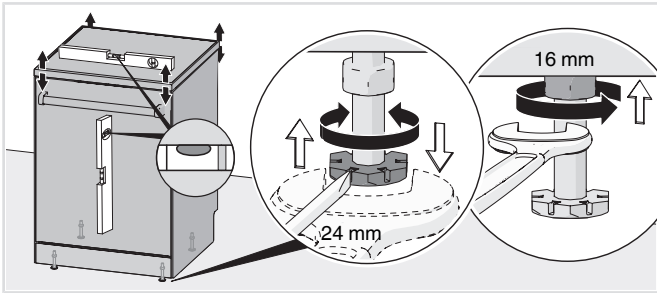

Freestanding

1. Make sure the area on which the dishwasher is to be installed is firm. Adjust the dishwasher's height using the four feet so that the dishwasher is level. The dishwasher may lean no more than 5 mm.
2. Lock the steel feet with the lock nuts.
3. Once the feet are properly adjusted, tighten the anti-tip feet firmly against the floor.

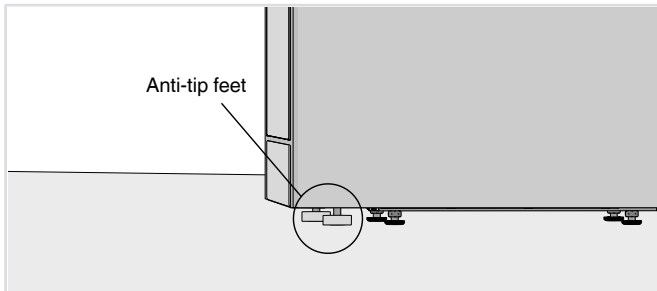

Built-in

1. Start by measuring the height from the floor to the bottom edge of the worktop.
2. Measure the height from the floor to the top edge of the dishwasher.
3. Adjust the dishwasher's feet by turning them clockwise to raise or anticlockwise to lower the machine.
4. Check that there is an air gap of at least 3 mm between the underside of the worktop and the top edge of the dishwasher.
5. Tighten the lock nuts (lock nut) on the rear feet.
6. Slide the dishwasher into place.
 - Pull through the drainage and supply hoses when the machine is slid into place.
 - Check that the hoses have no kinks or sharp bends, and check that there is nothing that can damage the hoses.

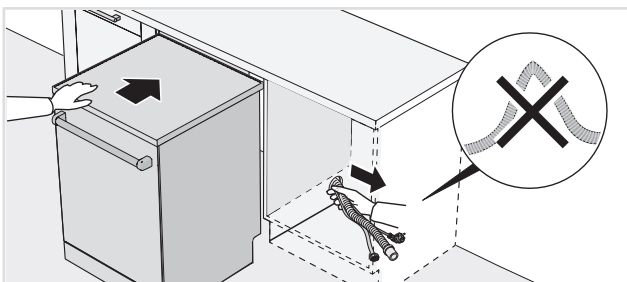

- Check that the machine is installed such that the door opens freely, otherwise door lock functionality may be disrupted.
7. Make any final adjustments to the front feet (the dishwasher may lean no more than 5 mm) and tighten the lock nuts.
 8. Once the feet are properly adjusted, tighten the anti-tip feet firmly against the floor.

The dishwasher can also be installed in a recess without its worktop. See *Remove dishwasher worktop*.

Drainage connection

This dishwasher is suitable for installing in a raised recess (to attain an ergonomic working height). This means that the dishwasher can be placed so that the drainage hose runs to a lower level than the bottom of the dishwasher, such as by routing it directly to a floor drain. The dishwasher is fitted with an integrated anti-siphon device to prevent the machine from being emptied of water during the wash cycle.

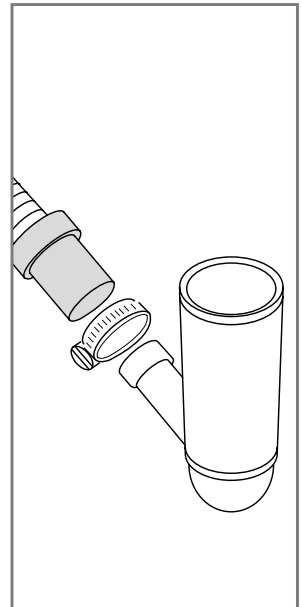
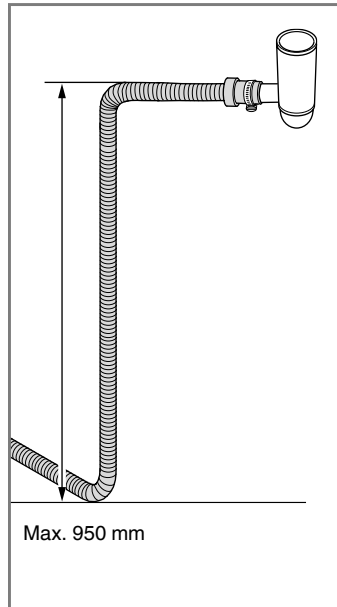
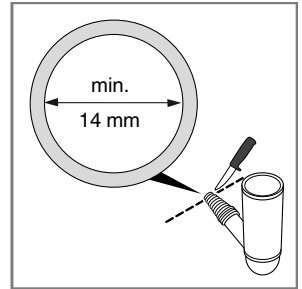
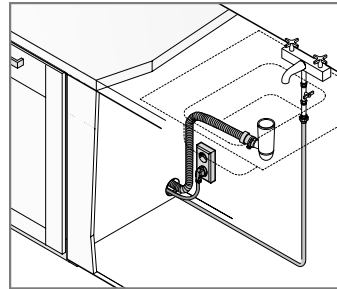

The drainage hose can also be connected to a connection nipple on the sink unit's water trap. The connection nipple must have an internal diameter of at least 14 mm.

The drainage hose may be extended by a maximum of 2.5 m (the total length of the drainage hose must not exceed 4.5 m). Any joins and connecting pipes must have an internal diameter of at least 14 mm. However, the drainage hose should ideally be replaced with a new hose without joins.

No part of the drainage hose may be more than 950 mm above the bottom of the dishwasher.

Attach the drainage hose with a hose clamp. Ensure that the drainage hose has no kinks.

Connection to water supply

Use only the inlet hose supplied with the dishwasher. Do not re-use old or other spare hoses.

The supply pipe must be fitted with a water tap (stopcock). The water tap must be easily accessible, so that the water can be shut off if the dishwasher has to be moved.

Once the installation is complete, turn on the water tap and allow the pressure to settle for a while. Check that all connections are watertight.

Connection to cold water supply

Connect the dishwasher to the cold water supply if the building is heated using oil, electricity or gas.

Connection to hot water supply

Connect the dishwasher to the hot water supply (max. 70 °C) if the building is heated using an energy-efficient means such as district heating, solar power or geothermal power. Choosing a hot water connection cuts dishwashing times and reduces the dishwasher's energy consumption.

NOTE!

Do not exceed the permitted water supply temperature. Certain materials used in some cookware cannot withstand strong heat. See Fragile dishes in the chapter Loading the dishwasher.

Electrical connection

Information about the electrical connection can be found on the serial number plate. This specification must match the electricity supply.

The dishwasher must be connected to an earthed socket.

The electric wall socket must be placed outside of the installation area to be easily accessible after installing the dishwasher. Do not use an extension cord!

NOTE!

Repairs and maintenance relating to safety or performance must be carried out by a qualified professional.

Remove dishwasher worktop

The dishwasher can be installed in a recess without its worktop. If the dishwasher's worktop is removed, the dishwasher must be installed under a separate worktop.

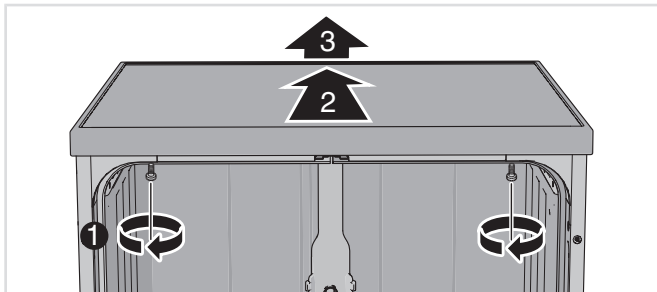

Read the chapter Troubleshooting before contacting the service department. If you have encountered a problem that you cannot resolve, please contact your nearest dealer, see www.asko.com.

When making contact, provide the details on the serial number plate. Include the article number (1) and the serial number (2).

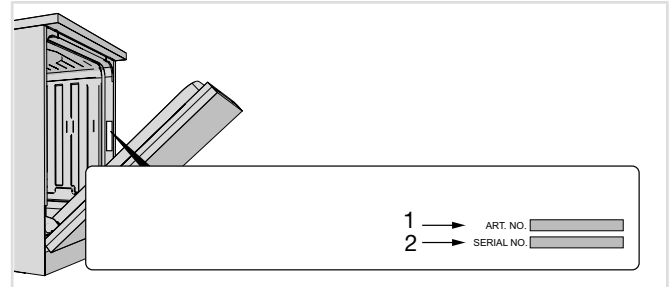

Information for test institute

Request test institute information via e-mail dishwashers@appliance-development.com.

The request should include the details on the serial number plate. Include the article number (1) and the serial number (2).

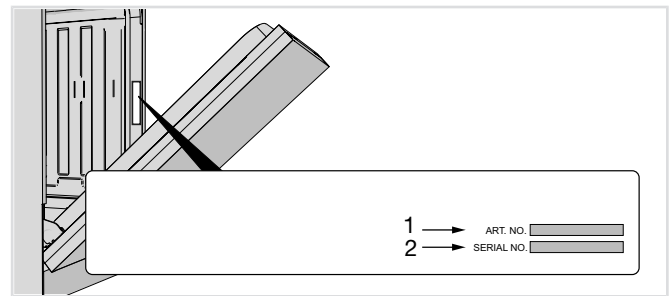

Quick guide

1.

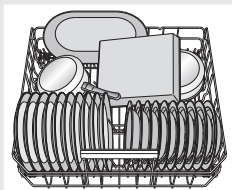

Load the baskets

(See page 5.)

Do not rinse dishes under running water before loading them in the dishwasher. Simply scrape off large food particles before loading the dishwasher.

2.

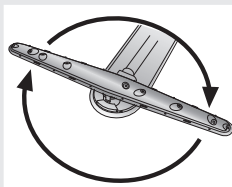

Check that the spray arms can rotate freely

Check also that the water tap is on.

Don't forget! Empty the coarse filter and clean the fine filter when necessary. (See page 15.)

3.

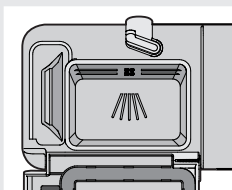

Add detergent

The detergent compartment has one smaller compartment for the prewash and one for the main wash. (See page 9.)

4.



Open the door and press the main power switch, close the door

5.



Check/Add rinse aid and salt

Top up salt and rinse aid to achieve good washing and drying results. (See page 4.)

💧 Top up rinse aid

★ Top up salt

6.



Select a programme, programme mode and any options

(See page 10.)

7.



Press Start/Stop

ASKO

