

GB

IE

MT

**DETAILED
INSTRUCTIONS**
FOR USE OF THE
ELECTRIC OVEN

gorenje
fantasy

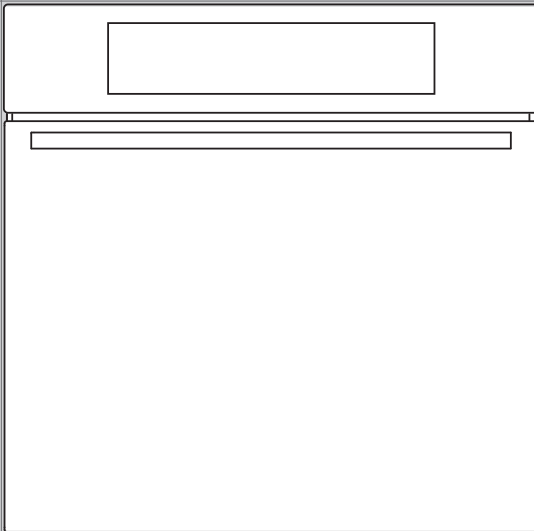

We thank you for your trust and the purchase of our appliance.

This detailed instruction manual is supplied to make the use of this product easier. The instructions should allow you to learn about your new appliance as quickly as possible.

Make sure you have received an undamaged appliance. If you do find transport damage, please contact the seller from which you purchased the appliance, or the regional warehouse from which it was supplied. The telephone number can be found on the invoice or on the delivery note.

Instructions for installation and connection are supplied on a separate sheet.

Instructions for use are also available at our website:

www.gorenje.com / < <http://www.gorenje.com> />



Important information



Tip, note

CONTENTS

4 IMPORTANT SAFETY INSTRUCTIONS 5 Before connecting the appliance	INTRODUCTION
6 THE ELECTRIC OVEN 10 Control unit 12 Technical specifications	
13 BEFORE USING THE APPLIANCE FOR THE FIRST TIME	PREPARING THE APPLIANCE FOR THE FIRST USE
14 SWITCHING ON THE APPLIANCE FOR THE FIRST TIME 14 Setting the clock	
15 STEPS OF THE COOKING PROCESS (1-7) 15 Step 1: CHOOSING THE COOKING SYSTEM 19 Step 2: TIMER FUNCTIONS - DURATION 20 Step 3: SAVING THE PROGRAM 21 Step 4: START THE COOKING PROCESS 21 Step 5: END OF COOKING AND SWITCHING OFF THE OVEN 22 Step 6: SELECTING ADDITIONAL FUNCTIONS/EXTRAS 23 Step 7: CHOOSING THE GENERAL SETTINGS	COOKING STEPS
25 DESCRIPTIONS OF SYSTEMS (COOKING MODES) AND COOKING TABLES	
42 MAINTENANCE & CLEANING 43 Conventional oven cleaning 43 Using the aqua clean function to clean the oven 44 Removing and cleaning wire and telescopic extendible guides 45 Installing the catalytic inserts 46 Cleaning the oven cavity ceiling 47 Removing and inserting the oven door (depending on the model) 50 Removing and inserting the oven door glass pane 51 Replacing the bulb	MAINTENANCE & CLEANING
52 TROUBLESHOOTING TABLE	TROUBLE-SHOOTING
53 DISPOSAL	OTHER

IMPORTANT SAFETY INSTRUCTIONS



CAREFULLY READ THE INSTRUCTIONS AND SAVE THEM FOR FUTURE REFERENCE.

This appliance can be used by children aged from 8 years and above and persons with reduced physical, sensory or mental capabilities or lack of experience and knowledge if they have been given supervision or instruction concerning use of the appliance in a safe way and understand the hazards involved. Children shall not play with the appliance. Cleaning and user maintenance shall not be made by children without supervision.

WARNING: The appliance and its accessible parts become hot during use. Care should be taken to avoid touching heating elements. Children less than 8 years of age shall be kept away unless continuously supervised.

WARNING: Accessible parts may become hot during use. Young children should be kept away.

During use the appliance becomes hot. Care should be taken to avoid touching heating elements inside the oven.

Only use the temperature probe recommended for use in this oven.

WARNING: Ensure that the appliance is switched off before replacing the lamp to avoid the possibility of electric shock.

Do not use harsh abrasive cleaners or sharp metal scrapers to clean the oven door glass/ the glass of hinged lids of the hob (as appropriate), since they can scratch the surface, which may result in shattering of the glass.

Do not use steam cleaners or high pressure cleaners to clean the appliance as this may result in an electric shock.

Means for disconnection must be incorporated in the fixed wiring in accordance with the wiring rules.

If the supply cord is damaged, it must be replaced by the manufacturer, its service agent or similarly qualified persons in order to avoid a hazard (only for appliances supplied with connection cord).

The appliance must not be installed behind a decorative door in order to avoid overheating.

The appliance is intended for household use. Do not use it for any other purpose, such as room heating, drying of pets or other animals, paper, fabrics, herbs etc. As this may lead to injury or fire hazard.

The appliance may only be connected to the power mains by an authorized service technician or expert. Tampering with the appliance or nonprofessional repair thereof may result in risk of severe injury or damage to the product.

If the power cords of other appliances located near this appliance are caught in the oven door, they may be damaged, which may in turn result in a short circuit. Therefore, keep the power cords of other appliances at a safe distance.

Do not line the oven walls with aluminium foil and do not place baking trays or other cookware on the oven bottom. Aluminium foil would prevent air circulation in the oven, hinder the cooking process, and ruin the enamel coating.

Oven door become very hot during operation. A third glass is installed for extra protection, reducing the temperature of the outside surface (only with some models).

Oven door hinges may be damaged when under excessive load. Do not place heavy pans on open oven door and do not lean against open oven door when cleaning the oven cavity. Never stand on the open oven door and do not let children to sit on it.

Do not lift the appliance by holding it by the door handle.

Appliance operation is safe with and without tray guides.

Make sure the vents are never covered or obstructed in any other way.

BEFORE CONNECTING THE APPLIANCE



Carefully read the instructions for use before connecting the appliance. Repair or any warranty claim resulting from incorrect connection or use of the appliance shall not be covered by the warranty.

THE ELECTRIC OVEN

(DESCRIPTION OF THE OVEN AND EQUIPMENT - DEPENDING ON THE MODEL)

The figure represents one of the built-in appliance models. Since the appliances for which these instructions were drawn up may have different equipment, some functions or equipment may be described in the manual that may not be present in your appliances.

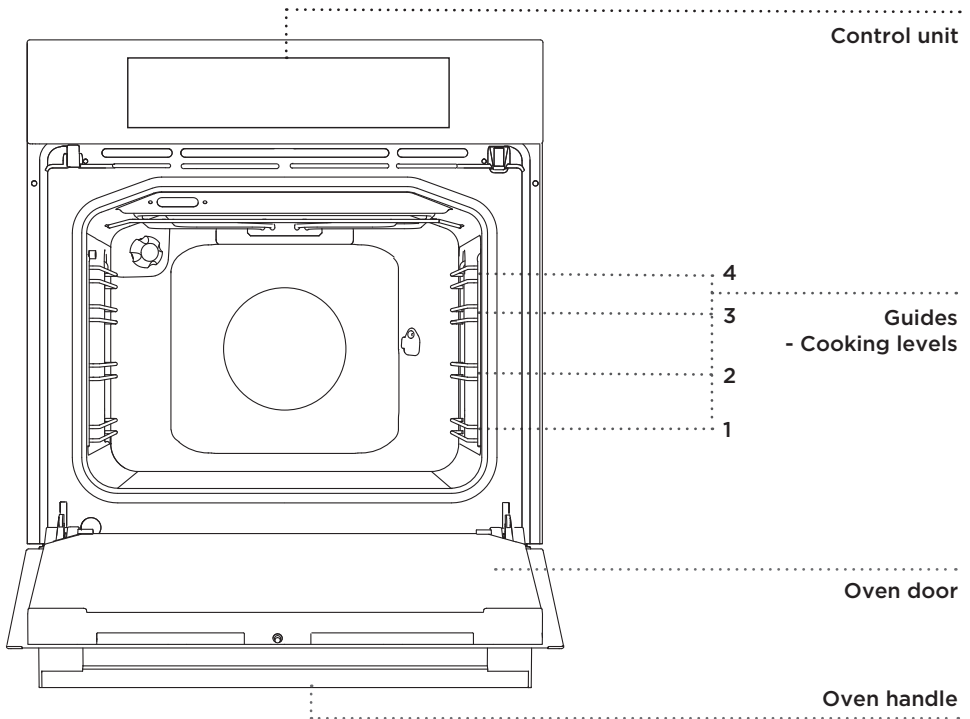

WIRE GUIDES

The wire guides allow preparation of the food on four levels (please note that the levels/guides are counted from the bottom up).

Guides 3 and 4 are intended for grilling.

TELESCOPIC PULL-OUT GUIDES

Telescopic pull-out guides may be fitted for the 2nd, 3rd, and 4th level.

Pull-out guides can be partly or fully extendible.

OVEN DOOR SWITCH

The switch deactivates oven heating and the fan when the oven door is opened during the cooking process. When the door is closed, the switch turns the heaters back on.

COOLING FAN

The appliance is fitted with a cooling fan that cools the housing and the appliance control panel.

EXTENDED OPERATION OF THE COOLING FAN

After the oven is switched off, the cooling fan continues to operate for a short while in order to cool the oven.

OVEN EQUIPMENT AND ACCESSORIES (depending on the model)

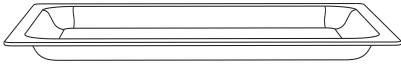

GLASS BAKING DISH is used for cooking with all oven systems. It can also be used as a serving tray.



The **GRID** is used for grilling or as support for a pan, baking tray or baking dish with the food.



There is a safety latch on the grid. Therefore, lift the grid slightly at the front when pulling it out from the oven.

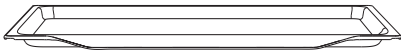

The **SHALLOW BAKING SHEET** is used for baking pastry and cakes.

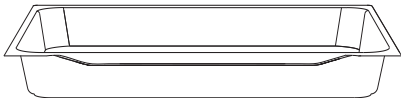

The **DEEP BAKING TRAY** is used for roasting meat and baking moist pastry. It can also be used as a drip tray.



Never place the deep baking tray in the first guide during the cooking process, except when grilling food or using the roasting spit and you are only using the deep tray as a drip tray.



As baking accessories heat up, their form may change. This does not affect their functionality and their original form will be restored when they cool down.

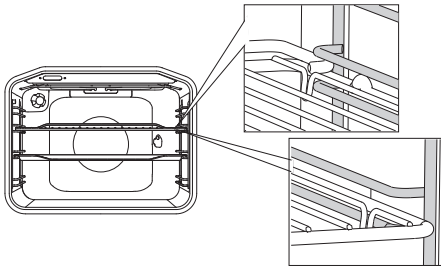

The grid or the tray should always be inserted into the groove between the two wire profiles.

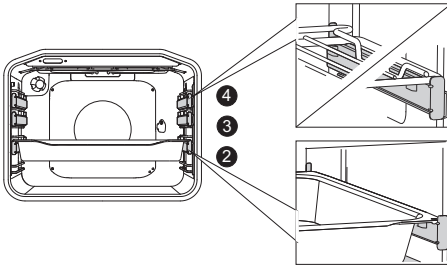

With telescopic extendible guides, first pull out the guides of one level and place the grid or the baking tray onto them. Then, push them in with your hand as far as they will go.

 Close the oven door when the telescopic guides are retracted all the way into the oven.

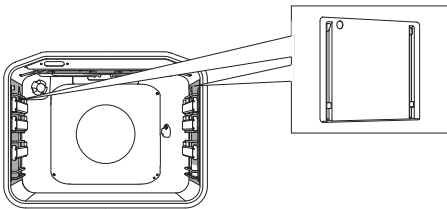

CATALYTIC INSERTS prevent the spraying of fat from accumulating on the sides of the oven cavity.

1 WHAT IS CATALYSIS?

Catalytic cleaning is a chemical process in which catalysts completely break down the grease particles during food preparation. In case of normal use, the service life of the catalytic inserts is equal to the service life of the appliance. If the inserts are worn out sooner, replacements are available at Gorenje service centres.

2 HOW TO CLEAN THE CATALYTIC INSERTS?

Catalytic inserts are cleaned automatically at temperatures of 85 °C or higher. In case of minor stains, they can be easily removed and cleaned with water and a soft cloth. Do not use aggressive cleaners and do not wash the inserts in the dishwasher. Streaks on the catalytic inserts do not affect their effectiveness.



The **ROTISSERIE** (meat skewer) is used for roasting meat. The set consists of a skewer support, skewer with screws, and a removable handle.

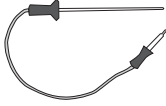

PROBE for roasting larger chunks of meat.



The appliance and some of the accessible parts tend to heat up during cooking. Use oven mitts.

CONTROL UNIT

FOOD SELECTION

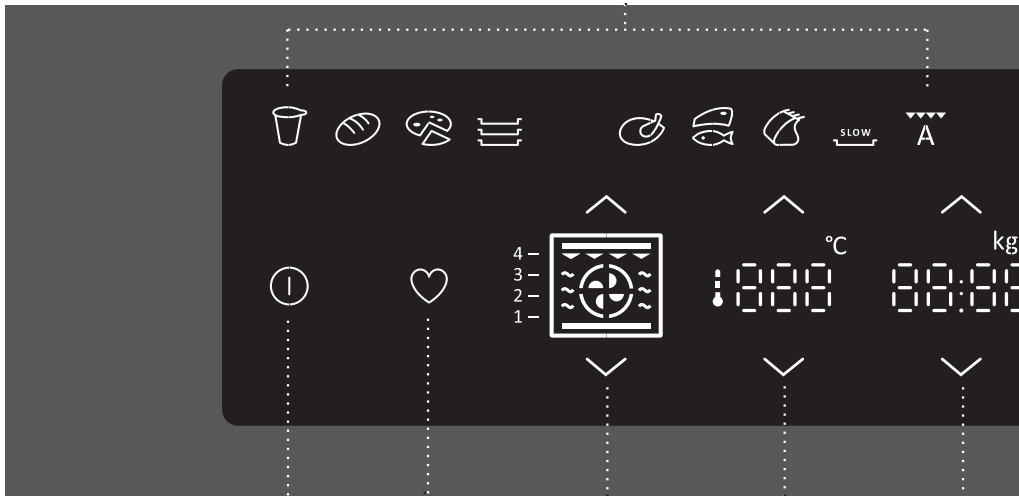

ON/OFF

MY RECIPES

COOKING SYSTEMS

TEMPERATURE

CLOCK, WEIGHT, PROBE

- ∧ Increase value
- ∨ Decrease value

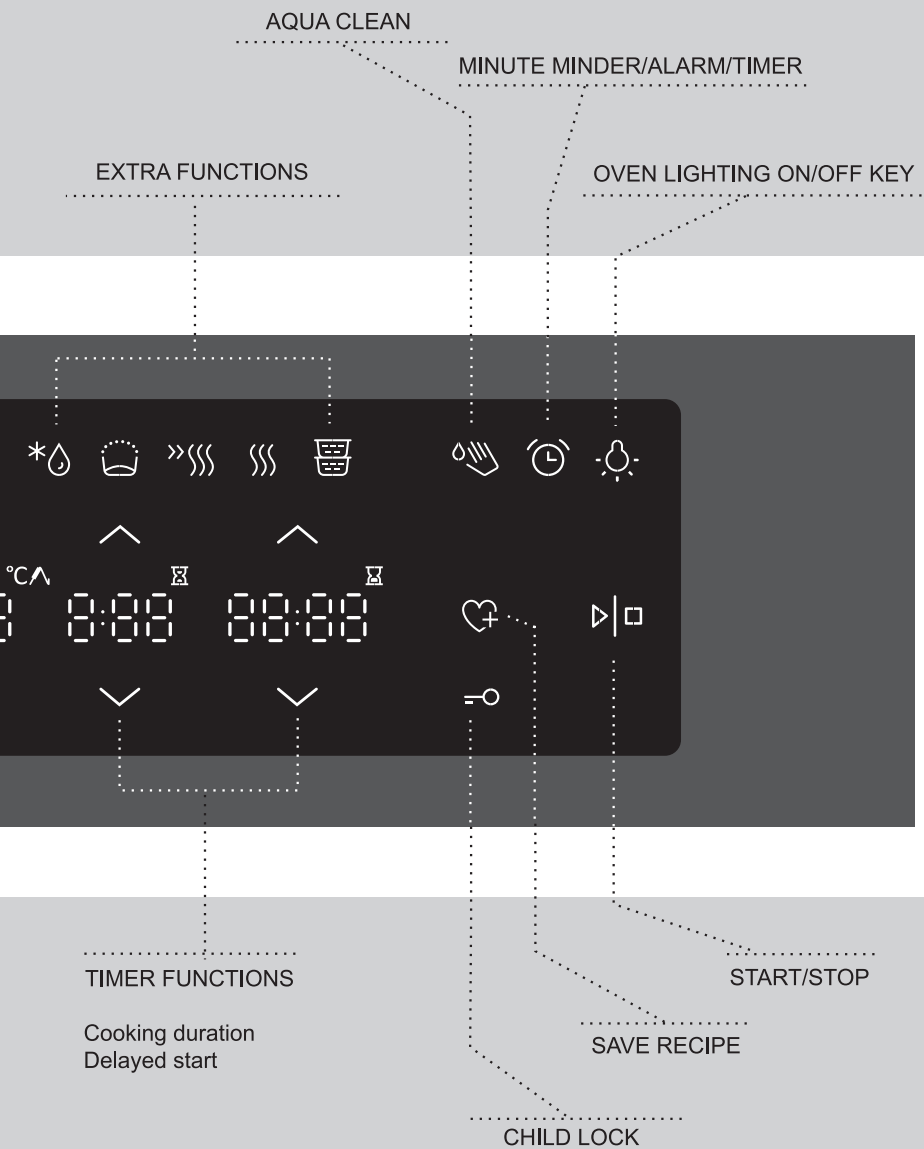

TIMER FUNCTIONS

Cooking duration
Delayed start

START/STOP

SAVE RECIPE

CHILD LOCK

NOTE:

The keys will respond better if you touch them with a larger area of your fingertip. Each time you press a key, a short acoustic signal will be sounded.

TECHNICAL SPECIFICATIONS

(DEPENDING ON THE MODEL)

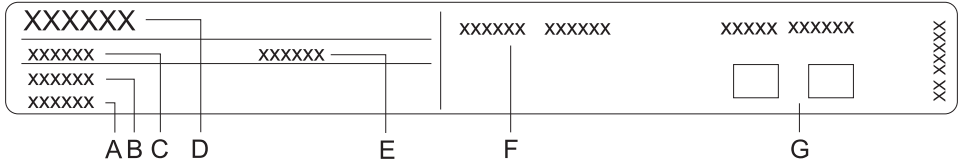

- A Serial number
- B Code/ID
- C Type
- D Brand
- E Model
- F Technical data
- G Compliance symbols

The rating plate indicating the basic information about the appliance is located at the edge of the oven and it is visible when the oven door is opened.

BEFORE USING THE APPLIANCE FOR THE FIRST TIME

Upon receiving the appliance, remove all parts, including any transport equipment, from the oven.

Clean all accessories and utensils with warm water and regular detergent. Do not use any abrasive cleaners.

Before using the oven for the first time, heat it with the upper and lower heater system at 200 °C for approximately one hour. The characteristic "new appliance" scent will be released; make sure the room is well ventilated.

SWITCHING ON THE APPLIANCE FOR THE FIRST TIME

SETTING THE CLOCK

After connecting your appliance or after an extended power outage, 12:00 will flash on the display.

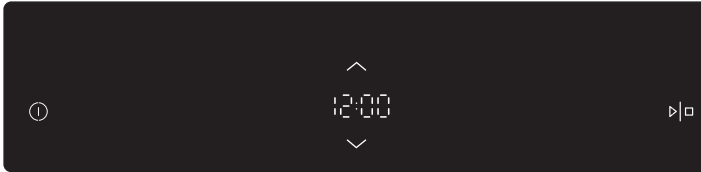

Touch the (^) and (v) keys to set the time of day. Confirm the setting with the START/STOP key.

 If you press and hold the value adjustment key, the rate at which the set value is being changed will increase.

 The oven will also work if the clock is not set. However, timer functions are not available in this case (see chapter setting the timer functions). After a few minutes of idling, the appliance will switch to standby mode.

CHANGING THE CLOCK SETTING

Clock settings may be changed when no timer function is activated (see chapter CHOOSING THE GENERAL SETTINGS).

STEPS OF THE COOKING PROCESS (1-7)

STEP 1: CHOOSING THE COOKING SYSTEM

The process of preparing food in your oven can be controlled in several ways:

A) COOKING BY SELECTING THE OPERATING MODE (Professional mode)

Use this mode when you wish to prepare any type and amount of food. All settings are selected by the user.

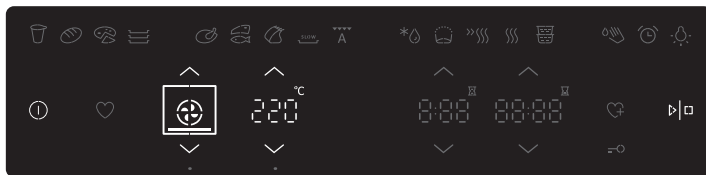

Touch the (∧) and (∨) keys to select the cooking mode/system and oven temperature.

COOKING SYSTEMS

COOKING SYSTEMS



The following extra functions can be selected as well:

 preheat

 cooking duration

 delayed start

Touch the START key.

 Rising temperature will be indicated on the display until the selected temperature  is reached. Cooking mode/system cannot be changed during operation; temperature, however, can be adjusted.











PREHEATING

Use the preheat function if you wish to heat the oven to the desired temperature as quickly as possible. Use the  symbol to activate the pre-heating function. The symbol will flash. Do not insert the food yet.

An acoustic signal is emitted when the selected temperature is reached. Open the door or confirm by pressing the START/STOP key. The symbol  will disappear. The program then resumes the cooking process with selected settings.

 When the preheat function is set, delayed start function cannot be used.

COOKING SYSTEMS

SYSTEM	DESCRIPTION	PRESET TEMPERATURE (°C)
COOKING SYSTEMS		
	UPPER AND BOTTOM HEATER The heaters in the bottom and in the ceiling of the oven cavity will radiate heat evenly into the oven interior. Pastry or meat can only be baked/roasted at a single height level.	200
	UPPER HEATER Only the heater on the oven cavity ceiling will radiate heat. Use this heater to brown the upper side of the dish.	150
	BOTTOM HEATER Only the heater on the bottom of the oven cavity will radiate heat. Use this heater to brown the lower side of the dish.	160
	GRILL Only grill heater, a part of the large grill set, will operate. Use this heater to grill a few open sandwiches or beer sausages, or for toasting bread.	240
	LARGE GRILL The upper heater and the grill heater will operate. The heat is radiated directly by the grill heater installed in the oven ceiling. To boost the heating effect, the upper heater is activated as well. This system is used for grilling a smaller amount of open sandwiches or beer sausages, and for toasting bread.	240
	GRILL WITH FAN Grill heater and the fan will operate. This combination is used to grill meat and to roast larger chunks of meat or poultry at a single height level. It is also appropriate for dishes au gratin and for browning to a crispy crust.	170
	HOT AIR AND BOTTOM HEATER Bottom heater, round heater, and the fan will operate. This is used to bake pizza, moist pastry, fruitcakes, leavened dough and shortcrust on several levels simultaneously.	200
	360° HOT AIR Round heater and the fan will operate. The fan installed in the back wall of the oven cavity makes sure the hot air constantly circulates around the roast or pastry. This mode is used for roasting meat and baking pastry at several levels simultaneously.	160
	ECO COOKING ¹⁾ In this mode, power consumption during the cooking process is optimized. This mode is used for roasting meat and baking pastry.	160
	BOTTOM HEATER AND FAN This is used for baking leavened but low-rising pastry and for preserving fruit and vegetables.	180

¹⁾ It is used for determining the energy efficiency class pursuant to the EN 60350-1 standard.

In this mode, the actual temperature in the oven is not displayed due to a special appliance operation algorithm and use of residual heat.

The number of the recommended guide level will be displayed for each selected system.

B) COOKING BY SELECTING THE TYPE OF FOOD (Auto mode)

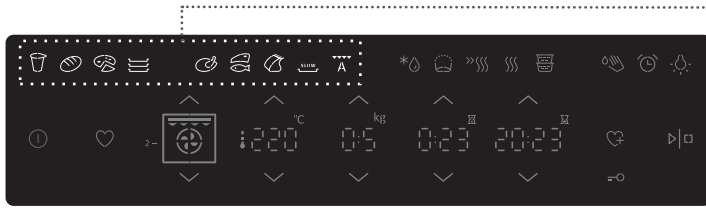

Touch the key to select the type of food. The selected symbol will be lit up.

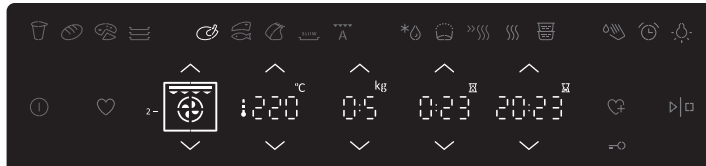



















Preset values will appear which you can still adjust:

- amount
- cooking temperature
- delayed start
- cooking duration

Touch the START key. Selected values will appear on the display.



SYMBOL	TYPE OF FOOD/ FUNCTION	PRESET TEMPERATURE (°C)	MAX. POSSIBLE TEMPERATURE	PRESET COOKING TIME (H/MIN)	AMOUNT (KG)	GUIDE (FROM THE BOTTOM)	WARNING	PRESET SYSTEM
	Yoghurt	40	40	3:00	-	2,3	Place the yoghurt cups onto the grid. (The function is only effective with appropriate equipment).	
	Bread	190	275	0:50	1	2	Cooking in a shallow tray.	
	Pizza *	200	275	0:20	1x0,5	2,3	Cooking/baking in a shallow tray	
	Cookies*	160	275	0:20	2x0.2	2,3	Cooking/baking in shallow trays on two levels simultaneously	
	Chicken	200	275	0:50	0.5	2	Cooking chicken on the grid in the second guide. Drip tray is in the bottom guide.	
	Cutlets/chops, fish*	240	275	0:18	4:0,50	3 3*	Cooking on the grid in the second guide. Drip tray is in the bottom guide. Turn the meat shortly after the first half of the cooking time.	
	Crown roast	180	275	1:25	0,50	2	Cooking/baking in a smaller baking dish on the grid	
	Slow cooking	100	130	4:00	-	2	Cooking/roasting meat (pork, beef, veal). Place the meat into a covered baking dish and add herbs, spices, and vegetables.	
	Automatic meat cooking - Auto Roast mode	180	275	1:00	-	2	Cooking various types of meat (steak, chops, fish)	

Asterisk (*) next to the type of food indicates that preheating is required. Preset cooking time does not include the time required for preheating.

STEP 2: TIMER FUNCTIONS - DURATION

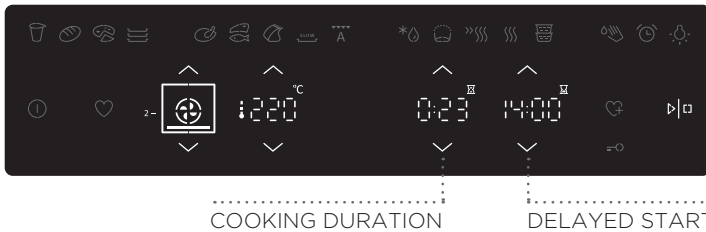

Touch the (∧) and (∨) keys to set the cooking duration.



Setting the cooking time

In this mode, you can define the duration of oven operation (cooking time). Set the desired cooking time and confirm the setting. Cooking end time is adjusted accordingly.

Press START to start the cooking process. All selected settings are indicated on the display.

All timer functions can be cancelled by setting the time to "0".



Setting the delayed start

In this mode, you may specify the duration of the cooking process (cooking time) and the time when you wish the cooking process to stop (end time). Make sure the clock is accurately set to current time.

Example:

Current time: noon

Cooking time: 2 hours

End of cooking: 6 pm

First, set the cooking time (cooking duration), i.e. 2 hours. The sum of the current time and cooking time is automatically displayed (2 pm). How, set the COOKING END TIME and set the time (6 PM). Press START to start the cooking process. The timer will wait for the start of the cooking process.



When the set time expires, the oven will automatically stop operating (end of cooking). An acoustic signal will be heard which you may turn off by pressing the ALARM key. After one minute, the acoustic signal will be switched off automatically.

After a few minutes of idling, the appliance will switch to standby mode. The time of day will appear.

STEP 3: SAVING THE PROGRAM

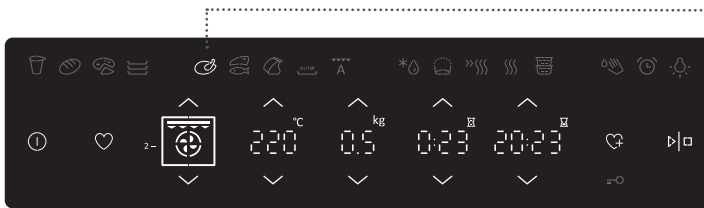

A) SAVING USER-DEFINED PROGRAMS (MY RECIPES)



Touch the key to select the type of food and choose your own settings:

- temperature
- (amount)
- cooking duration
- delayed start

Touch the  key and hold it for three seconds to save your settings. The symbol for the selected type of food will flash twice.

 Your favourite recipes that you have previously stored in the memory can be retrieved and used at any time. Touch the  key. All your stored programs will be displayed.

B) SAVING THE PRESET VALUES OF THE OVEN SYSTEM

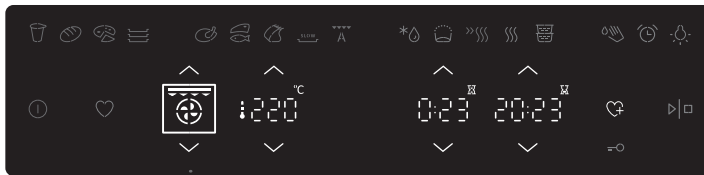

Choose the oven system. Preset values will appear which you can still adjust:

- temperature
- Cooking duration
- Delayed start

Touch the  key and hold it for 3 seconds to save the settings (they will light up twice).

STEP 4: START THE COOKING PROCESS

Start the cooking process by pressing the START/STOP key and holding it for a while. If no timer function is selected, the cooking duration time, and the operation and temperature symbols will appear on the display unit.



STEP 5: END OF COOKING AND SWITCHING OFF THE OVEN

After the cooking process, all timer settings are also paused and cancelled. Time of day (clock) will be displayed. After five minutes of idling, the appliance will switch to standby mode.

 After the cooking process, all timer settings are also paused and cancelled, except for the minute minder. Time of day (clock) will be displayed. The cooling fan will continue to operate for a while.

 After the use of the oven, some water may be left in the condensate channel (underneath the door). Wipe the channel with a sponge or a cloth.

STEP 6: SELECTING ADDITIONAL FUNCTIONS/EXTRAS

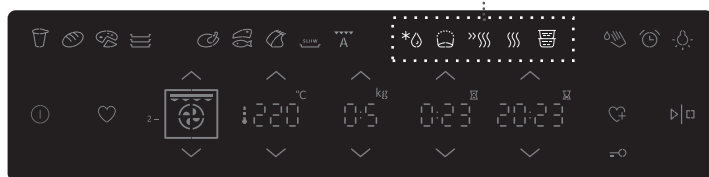

Touch the key to select the cooking function



Defrost

In this mode, the air will circulate without any heaters operating. Only the fan will be activated. Use this function to slowly defrost frozen food (cakes, pastry, bread, rolls, and deep-frozen fruit). By selecting the relevant symbol you may specify the type of food, weight, or defrosting start and end time. Halfway through the defrost time, the pieces should be turned over, stirred and separated if they were frozen together.



Dough - rising and proofing

Use this function to rise or proof leavened dough. Optimum temperature is maintained which will stimulate the yeasts and speed up the rising process.



Quick preheat

Use the preheat function if you wish to heat the oven to the desired temperature as quickly as possible. This mode is not appropriate for cooking. When the oven heats up to the selected temperature, the preheat process is completed and the oven is ready for cooking with the selected cooking mode.



Reheating:

Reheating can be used to keep the food that is already cooked warm. Select the symbol to set the temperature, and reheating start and end time.



Steam column

Use this function to simultaneously cook different types of food in dishes placed in a column. The food is cooked with steam rising from the food placed at the bottom. Place the dishes with higher food content (sauces, soups) into the first dish; place meat, vegetables, and sides into the second dish; and place the desserts into the third one. (The function is only effective with appropriate equipment).

STEP 7: CHOOSING THE GENERAL SETTINGS



Touch the key to choose the setting.



Aqua clean

Use it to remove stains. Pour 0.6 l water into the deep baking tray and place it in the lower guide. After 4 minutes, food residues on the enamel surfaces will have softened and they will be easy to wipe off with a damp cloth.



Setting the minute minder

The minute minder can be used independently of the oven operation. Activate it by pressing the key. The longest possible setting is 10 hours. When the time expires, an acoustic signal will be heard which you may turn off by touching the CLOCK key. After one minute, the acoustic signal will be switched off automatically.



Oven lighting

Oven lighting is switched on automatically when the door is opened or when the oven is switched on.

After the end of the cooking process or when the door is closed, the light will remain on for another minute. The light inside the oven can be switched on or off by pressing the LIGHT key.



CHILD LOCK

Activate it by touching the LOCK key (key symbol) and holding it for a while. Touch the key again to deactivate the child lock.



If the child lock is activated with no timer function engaged (only clock is displayed), then the oven will not operate. If the child lock is activated after a timer function has been set, then the oven will operate normally; however, it will not be possible to change the settings.

When the child lock is activated, systems (cooking modes) or additional functions cannot be changed. Only the cooking/baking/roasting process can be stopped or switched off. Child lock remains active after the oven is switched off. To select a new system, the child lock must first be deactivated.

Time

Set the time of day after the appliance is connected to the power mains for the first time or after being disconnected from the power mains for a longer period of time (more than one week).

The clock can be set whenever the appliance is switched off by pressing the ON/OFF key. Choose the setting using the (∧) and (∨) arrows.

8sek 

Setting the contrast and sound, and resetting to factory settings

The settings can be made when the  symbol appears.

Press the "light" symbol and hold it for eight seconds. "bri" appears on the display, along with two fully lit bars.

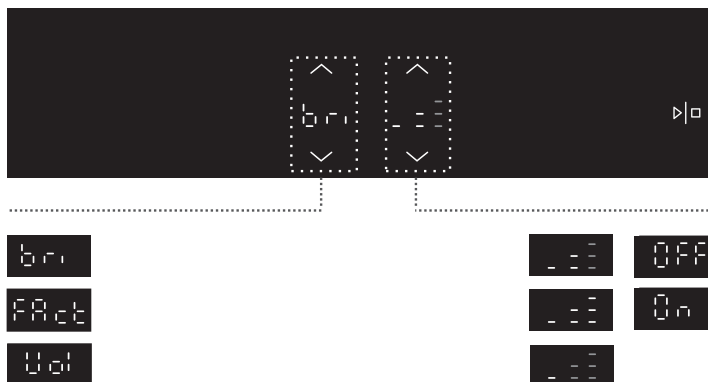

Choose the setting using the (∧) and (∨) arrows.
Touch the  key to confirm.



After a power outage or after switching off the appliance, all extra user settings are restored.

DESCRIPTIONS OF SYSTEMS (COOKING MODES) AND COOKING TABLES

If your desired food cannot be found in the cooking table, find information for similar food.

The information displayed applies to cooking in a single level.

An interval of suggested temperature is indicated. Start with a lower temperature setting and increase it if you find the food is not browned sufficiently.

Cooking times are rough estimates and may vary subject to some conditions.

Only preheat the oven if required by the recipe of in the tables in this instruction manual. Heating an empty oven consumes a lot of energy. Hence, baking several types of pastry or several pizzas successively will save a lot of energy as the oven will already have been preheated.

Use dark, black silicon-layered or enamel-coated baking sheets and trays as they conduct the heat very well.

When cooking larger chunks of meat or pastry, a lot of steam will be generated inside the oven, which in turn may condense on the oven door. This is a normal phenomenon which will not affect the operation of the appliance. After the cooking process, wipe the door and the door glass dry.

Do not cool the food in a closed oven to prevent condensation (dew).

Standard doneness levels and recommended final core temperature for different types of meat

Type of food	Food core temperature (°C)	Meat colour on cross-section, and colour of juices
BEEF		
Rare	40-45	meaty red, like raw meat, little juice
Medium rare	55-60	light red, a lot of light red juice
Medium	65-70	pink, small amount of pale pink juice
Well done	75-80	evenly greyish brown, little colourless juice
VEAL		
Well done	75-85	red-brown
PORK		
Medium	65-70	light pink
Well done	75-85	yellow-brown
LAMB		
Well done	79	grey, pinkish juice
MUTTON		
Rare	45	meaty red
Medium rare	55-60	light red
Medium	65-70	pink in the middle
Well done	80	grey
GOAT MEAT		
Medium	70	pale pink, pink juices
Well done	82	grey, juices only slightly pink
POULTRY		
Well done	82	light grey
FISH		
Well done	65-70	white to grey-brown

UPPER AND BOTTOM HEATER

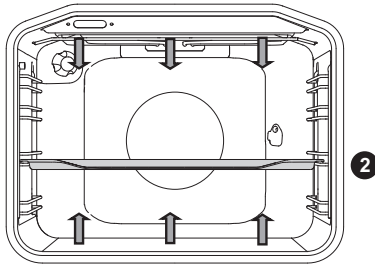

The heaters in the bottom and in the ceiling of the oven cavity will radiate heat evenly into the oven interior.

Roasting meat:

Use enamel coated, tempered glass, clay, or cast iron pan or tray. Stainless steel trays are not suitable as they strongly reflect the heat.

Use enamel coated, tempered glass, clay, or cast iron pan or tray. Stainless steel trays are not suitable as they strongly reflect the heat.

Type of food	Weight (g)	Guide (from the bottom)	Temperature (°C)	Cooking time (minutes)
MEAT				
Pork roast	1500	2	180-200	90-110
Pork shoulder	1500	2	180-200	100-120
Pork roulade	1500	2	180-200	120-140
Meat loaf	1500	2	200-210	60-70
Beef roast	1500	2	170-190	120-140
Veal roulade	1500	2	180-200	90-120
Lamb sirloin	1500	2	180-200	80-100
Rabbit loin	1500	2	180-200	50-70
Deer shank	1500	2	180-200	100-120
Pizza*	/	2	200-220	20-30
Chicken	1500	2	190-210	70-90
FISH				
Braised fish	1000	2	210	50-60

Use this system to roast chicken, if the appliance does not have the system.

Use this system to bake pizza, if the appliance does not have the system.

The symbol * means that the oven should be preheated using the selected cooking system.

Baking pastry

Only use one level and dark baking sheets or trays. In light-coloured baking sheets or trays, the browning of the pastry will be poorer, as such equipment will reflect the heat. Always place the baking trays on the grid. If you are using the supplied baking sheet, remove the grid. Cooking time will be shorter if the oven is preheated.

Type of food	Guide (from the bottom)	Temperature (°C)	Cooking time (minutes)
PASTRY			
Vegetable soufflé	2	190-200	30-35
Sweet soufflé	2	190-200	30-35
Rolls*	2	190-210	20-30
White bread*	2	180-190	50-60
Buckwheat bread*	2	180-190	50-60
Whole grain bread*	2	180-190	50-60
Rye bread*	2	180-190	50-60
Spelt bread*	2	180-190	50-60
Walnut cake	2	170-180	50-60
Sponge cake*	2	160-170	25-30
Cheesecake	2	170-180	65-75
Cupcakes	2	170-180	25-30
Small pastries made with yeast dough	2	200-210	20-30
Cabbage pirozhki	2	185-195	25-35
Fruitcake	2	150-160	40-50
Meringue cookies	2	80-90	120-130
Jelly-filled rolls (Buchtel)	2	170-180	30-40

The symbol * means that the oven should be preheated using the selected cooking system.

Cooking error	Tip
Is the cake done?	<ul style="list-style-type: none"> • Pierce the cake at the top with a wooden toothpick or skewer. If there are no traces on the pick or the skewer when pulled out, the cake is done.
Did the cake collapse?	<ul style="list-style-type: none"> • Check the recipe. • Next time, use less liquid. • Note the mixing time when using small mixers, blenders etc.
The cake is too light at the bottom?	<ul style="list-style-type: none"> • Use a dark-coloured baking sheet or tray. • Place the baking sheet one guide lower and switch on the lower heater towards the end of the cooking progress.
Cake with moist stuffing is underdone?	<ul style="list-style-type: none"> • Increase temperature and extend baking time.



Do not insert the deep baking tray into the first guide.

LARGE GRILL, GRILL

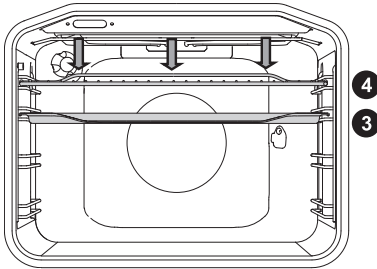

When grilling food with the large grill, the upper heater and the grill heater fitted on the ceiling of the oven cavity will operate.

When grilling food, the upper heater and the grill heater fitted on the ceiling of the oven cavity will operate.

Max allowed temperature : 240°C

Preheat the infrared (grill) heater for five minutes.

Supervise the cooking process at all times. The meat may burn quickly due to high temperature.

Roasting with the grill heater is suitable for crispy and low-fat cooking of bratwurst, cuts of meat and fish (steaks, escalopes, salmon steaks or fillets etc.) or toasted bread.

When grilling directly on the grid, smear it with oil to prevent the meat from sticking onto it and insert it into the 4th guide. Insert the drip tray in to the 1st or 2nd guide. When grilling in a baking tray, make sure there is enough liquid in the tray to prevent burning. Turn the meat during cooking.

After grilling, clean the oven, the accessories, and the utensils.

Grilling table - small grill

Type of food	Weight (g)	Guide (from the bottom)	Temperature (°C)	Cooking time (minutes)
MEAT				
Beefsteak, rare	180 g/piece	3	230	15-20
Pork neck fillet	150 g/piece	3	230	18-22
Cutlets/chops	280 g/piece	3	230	20-25
Grill sausages	70 g/piece	3	230	10-15
TOASTED BREAD				
Toast	/	4	230	3-6
Open sandwiches	/	4	230	3-6

Grilling table - large grill

Type of food	Weight (g)	Guide (from the bottom)	Temperature (°C)	Cooking time (minutes)
MEAT				
Beefsteak, rare	180 g/piece	3	230	15-20
Beefsteak, well done	180 g/piece	3	230	18-25
Pork neck fillet	150 g/piece	3	230	20-25
Cutlets/chops	280 g/piece	3	230	20-25
Veal escalope	140 g/piece	3	230	20-25
Grill sausages	70 g/piece	3	230	10-15
Spam (Leberkäse)	150 g/piece	3	230	10-15
FISH				
Salmon steaks/fillets	200 g/piece	3	230	15-25
TOASTED BREAD				
Toast	/	4	230	1-3
Open sandwiches	/	4	230	2-5

When grilling in a baking tray, make sure there is enough liquid in the tray to prevent burning. Turn the meat during cooking.

When baking trout, pat the fish dry with a paper towel. Season on the inside; coat with oil on the outside and place on the grid. Do not turn the fish when grilling.



Always keep the oven door closed when using the grill (infrared) heater.

Grill heater, grid, and other oven accessories get very hot during grilling. Therefore, use oven mitts and meat tongs.

Cooking with the rotisserie (depending on the model)

Maximum temperature when using the rotisserie is 240°C.

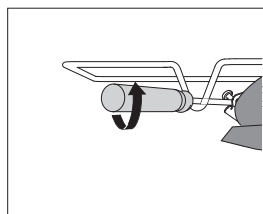
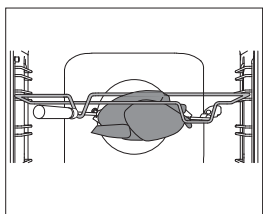
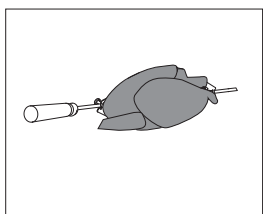
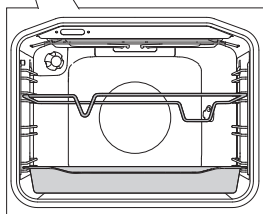
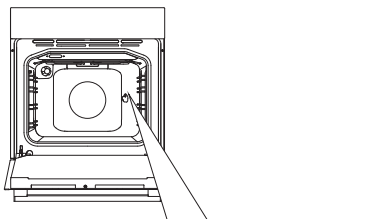

1 Insert the skewer support into the 3rd guide from the bottom and place the deep tray into the bottom (1st) guide to serve as a drip tray.

2 Impale the meat on the skewer and tighten the screws.

3 Place the skewer handle on the front skewer support and insert the tip into the opening in the right hand side of the rear oven cavity wall (the opening is protected with a rotating cover).

4 Undo the skewer handle and close the oven door.

Switch on the oven and select the LARGE GRILL system.



The grill will only operate when the oven door is closed.

GRILL WITH FAN

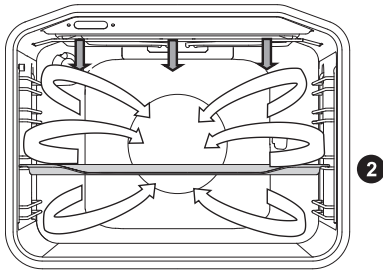

In this operating mode, the grill heater and the fan operate simultaneously. Suitable for grilling meat, fish, and vegetables.

(See descriptions and tips for GRILL.)

Type of food	Weight (g)	Guide level (from the bottom)	Temperature (°C)	Cooking time (min)
MEAT				
Duck	2000	2	150-170	80-100
Pork roast	1500	2	160-170	60-85
Pork shoulder	1500	2	150-160	120-160
Pork shank	1000	2	150-160	120-140
Half of chicken	700	2	190-210	50-60
Chicken	1500	2	190-210	60-90
FISH				
Trout	200 g/piece	2	200-220	20-30

HOT AIR AND BOTTOM HEATER

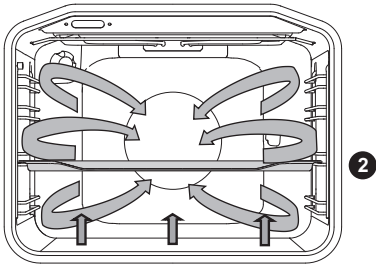

The bottom heater, the round heater, and the hot air fan will operate. Suitable for baking pizzas, apple pies, and fruitcakes.

(See descriptions and tips for UPPER and BOTTOM HEATER.)

Type of food	Guide (from the bottom)	Temperature (°C)	Cooking time (minutes)
Cheesecake, short crust	2	150-160	65-80
Pizza *	2	200-210	15-20
Quiche Lorraine, shortcrust	2	180-200	35-40
Apple pie, leavened dough	2	150-160	35-40
Apple strudel, phyllo dough	2	170-180	45-65

The symbol * means that the oven should be preheated using the selected cooking system.

Roasting with the meat probe (depending on the model)

In this mode, set the desired temperature of the food core. The oven operates until the food core reaches the set temperature. Temperature core is measured by the temperature probe.

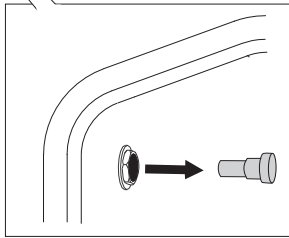
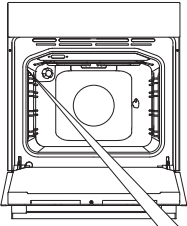

1 Remove the metal cap (the socket is located in the front upper corner of the oven right wall).

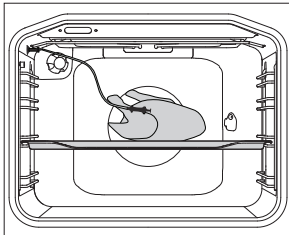

2 Connect the meat probe plug to the socket and stick the probe into the food. (If any timer settings were activated, they will be cancelled.)



When the probe is connected, "Prob" will appear on the display unit. Set the desired temperature. Touch the START key.

Preset temperature and probe temperature will be displayed.



During cooking, the rising temperature of the core will be displayed (the desired core temperature may be adjusted in the range from 30 to 99 °C during the cooking process). When the set core temperature is reached, the cooking process will stop.

An acoustic signal will be heard which you may turn off by touching any key. After one minute, the acoustic signal will be switched off automatically. Clock will appear on the display.

After the cooking process, replace the metal cap of the meat probe socket.

Type of food	Weight (g)	Guide (from the bottom)	Food core temperature
MEAT			
Beef tenderloin	1000	2	55-75*
Chicken, whole	1500	2	85-90
Turkey	4000	2	85-90
Pork roast	1500	2	70-85
Meat loaf	1000	2	80-85
Veal	1000	2	75-85
Lamb	1000	2	75-85
Venison	1000	2	75-85
Fish	1000	2	75-85

* rare = 55-60 °C; medium = 65-70 °C; well done = 70-75 °C



Only use the probe intended for use with your oven. Make sure the probe does not touch the heater during cooking. After the cooking process, the probe will be very hot. Take care to prevent burning.

360° HOT AIR

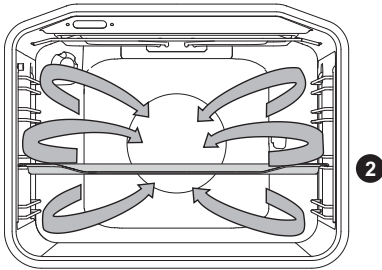

Round heater and the fan will operate. The fan installed in the back wall of the oven cavity makes sure the hot air constantly circulates around the roast or pastry.

Roasting meat:

Use enamel coated, tempered glass, clay, or cast iron pan or tray. Stainless steel trays are not suitable as they strongly reflect the heat.

Provide enough liquid during the cooking process to prevent the meat from burning. Turn the meat during roasting. The roast will remain juicier if you cover it.

Type of food	Weight (g)	Guide (from the bottom)	Temperature (°C)	Cooking time (minutes)
MEAT				
Pork roast, including skin	1500	2	170-180	140-160
Duck	2000	2	160-170	120-150
Goose	4000	2	150-160	180-200
Turkey	5000	2	150-170	180-220
Chicken breast	1000	3	180-200	60-70
Stuffed chicken	1500	2	170-180	90-110

Baking pastry

Preheating is recommended.

Biscuits and cookies can be baked in shallow baking sheets on several levels simultaneously (2nd and 3rd).

Note that baking time can differ even with if the baking sheets used are the same. The biscuits in the upper baking sheet may be ready sooner than those in the lower one.

Always place the baking trays on the grid. If you are using the supplied baking sheet, remove the grid.

For even browning, make sure the biscuits are of the same thickness.

Type of food	Guide (from the bottom)	Temperature (°C)	Cooking time (minutes)
PASTRY			
Sponge cake	2	150-160	25-35
Crumble cake	2	160-170	25-35
Fruit cake, sponge	2	150-160	45-65
Sponge roll*	2	160-170	15-25
Fruit cake, short crust	2	160-170	50-70
Apple strudel	2	170-180	40-60
Biscuits, short crust*	2	150-160	15-25
Biscuits, pressed*	2	140-150	15-25
Cookies, leavened	2	170-180	20-35
Cookies, phyllo dough	2	170-180	20-30
PASTRY - FROZEN			
Apple and cottage cheese strudel	2	170-180	50-70
Pizza	2	170-180	20-30
Fried potatoes, oven-ready	2	170-180	20-35
Croquettes, oven-baked	2	170-180	20-35

The symbol * means that the oven should be preheated using the selected cooking system.



Do not insert the deep baking tray into the first guide.

BOTTOM HEATER AND FAN

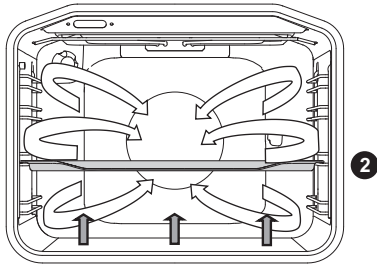

This is used for baking leavened but low-rising pastry and for preserving fruit and vegetables. Use the second guide from the bottom and a rather shallow baking tray to allow the hot air to circulate across the upper side of the dish.

PRESERVATION

Prepare the food to be preserved and jars as usual. Use jars with a rubber sealing ring and a glass cover. Do not use jars with threaded or metal caps or metal tins. Make sure the jars are of equal size, filled with the same contents, and tightly sealed.

Pour 1 litre of hot water into the deep tray (approx. 70°C) and place 6 1-litre jars into the tray. Place the tray into the oven on the second guide.

During preservation, observe the food and cook until the liquid in the jars starts to simmer - when bubbles appear in the first jar.

Type of food	Guide (from the bottom)	Temperature (°C)	Time to simmer (min)	Temperature and time after the start of simmer	Resting time in the oven (min)
FRUIT					
Strawberries	2	160-180	30-45	/	20-30
Stone fruits	2	160-180	30-45	/	20-30
Fruit mush	2	160-180	30-45	/	20-30
VEGETABLES					
Pickled gherkins	2	160-180	30-45	/	20-30
Beans/carrots	2	160-180	30-45	120°C, 45-60 min	20-30



Eco

ECO COOKING

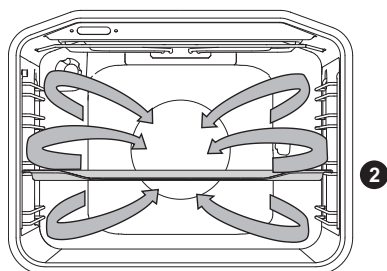

Round heater and the fan will operate. The fan installed in the back wall of the oven cavity makes sure the hot air constantly circulates around the roast or pastry.

Type of food	Guide (from the bottom)	Temperature (°C)	Cooking time (min.)
MEAT			
Pork roast, 1 kg	2	180	140-160
Pork roast, 2 kg	2	180	150-180
Beef roast, 1 kg	2	190	120-140
FISH			
Whole fish, 200 g/piece	2	180	40-50
Fish fillet, 100 g/piece	2	190	25-35
PASTRY			
Piped cookies	2	160	20-25
Small cupcakes	2	170	25-35
Sponge roll	2	170	25-30
Fruit cake, short crust	2	170	55-65
GRATINS			
Potatoes au gratin	2	170	40-50
Lasagne	2	180	40-50
FROZEN FOOD			
French fries, 1 kg	2	200	25-40
Chicken nuggets, 0.7 kg	2	200	25-35
Fish sticks, 0.6 kg	2	200	20-30



Do not insert the deep baking tray into the first guide.

AUTOMATIC COOKING OF MEAT - AUTO ROAST MODE

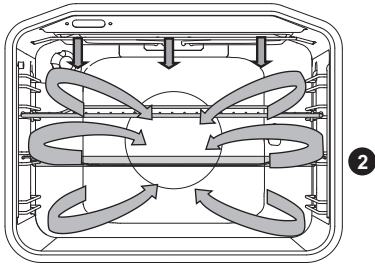

In the automatic meat cooking mode (Auto Roast), the upper heater will operate in combination with the round heater. It is used for roasting all types of meat.

In the Auto Roast mode, the upper heater will operate in combination with the grill heater and the round heater. It is used for roasting all types of meat.

When grilling directly on the grid, smear it with oil to prevent the meat from sticking onto it and insert it into the 3rd guide. Insert a drip tray into the 2nd guide. When roasting meat in a baking tray, insert it into the 2nd guide.

Type of food	Weight (g)	Guide (from the bottom)	Temperature (°C)	Cooking time (minutes)	Food core temperature
MEAT					
Beef tenderloin	1000	2	190-210	45-55	55-75*
Chicken, whole	1500	2	170-190	60-70	85-90
Turkey	4000	2	160-180	150-180	85-90
Pork roast	1500	2	150-170	100-120	70-85
Meat loaf	1000	2	160-180	70-80	80-85
Veal	1000	2	170-190	100-120	75-85
Lamb	1000	2	170-190	50-60	75-85
Venison	1000	2	170-190	55-65	75-85
Fish	1000	2	160-180	35-55	75-85

* rare = 55-60 °C; medium = 65-70 °C; well done = 70-75 °C

MAINTENANCE & CLEANING



Be sure to unplug the appliance from the power supply and wait for the appliance to cool down.

Children should not clean the appliance or perform maintenance tasks without proper supervision.

Aluminium finish

Clean the aluminium finish with non-abrasive liquid cleaners intended for such surfaces. Apply the cleaner onto a wet cloth and clean the surface. Then, rinse the surface with water. Do not apply the cleaner directly onto the aluminium finish.

Do not use abrasive cleaners or sponges.

Note: The surface should not come into contact with oven cleaning sprays as this may result in visible and permanent damage.

Stainless steel sheet front side of the housing

(depending on the model)

Clean this surface only with a mild detergent (soapsuds) and a soft sponge that will not scratch the finish. Do not use abrasive cleaners or cleaners containing solvents as they may damage the housing finish.

Lacquer-coated surfaces and plastic parts

(depending on the model)

Do not clean the knobs and buttons, door handles, stickers, and rating/type plates with abrasive cleaners or abrasive cleaning materials, alcohol-based cleaners, or with alcohol. Immediately remove any stains with a soft non-abrasive cloth and some water, in order to avoid damaging the surface.

You may also use cleaners and cleaning materials intended for such surfaces as instructed by their respective manufacturers.



The aluminium-coated surfaces should not come into contact with oven cleaning sprays as this may result in visible and permanent damage.

CONVENTIONAL OVEN CLEANING

You may use the standard cleaning procedure to clean stubborn dirt in the oven (using cleaners or an oven spray). After such cleaning, rinse the cleaner residues thoroughly.

Clean the oven and the accessories after each use to prevent the dirt from burning into the surface. The easiest way to remove fat is by using warm soapsuds while the oven is still warm.

With stubborn dirt and grime, use conventional oven cleaners. Rinse the oven thoroughly with clean water to remove all cleaner residue.

Never use aggressive cleaners, abrasive cleaners, abrasive sponges, stain and rust removers etc.

Clean the accessories (baking sheets and trays, grids etc.) with hot water and detergent.

The oven, the oven cavity and the baking trays are lined with a special enamel coating for a smooth and resistant surface. This special coating makes cleaning at room temperature easier.

USING THE AQUA CLEAN FUNCTION TO CLEAN THE OVEN

Pour 0.6 l of water into a glass or shallow baking dish and insert it into the lower guide.

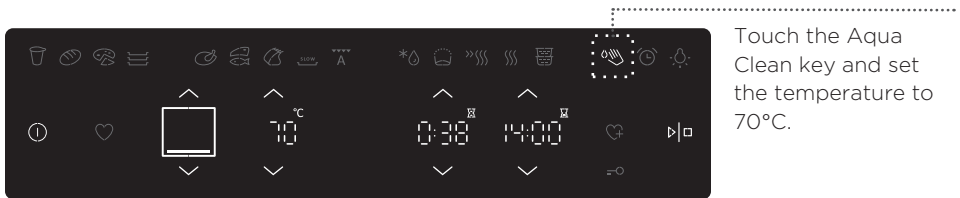

Touch the Aqua Clean key and set the temperature to 70°C.

Touch the START key. An acoustic signal will be emitted when the cleaning process is complete.

 After 30 minutes, food residues on the oven enamel walls will have softened and they will be easy to clean with a damp cloth.



Use the Aqua Clean system when the oven has fully cooled down.

REMOVING AND CLEANING WIRE AND TELESCOPIC EXTENDIBLE GUIDES

Only use conventional cleaners to clean the guides.

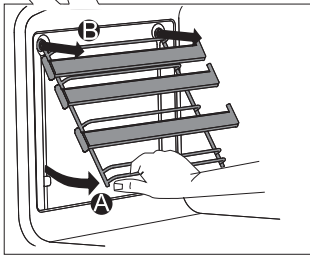
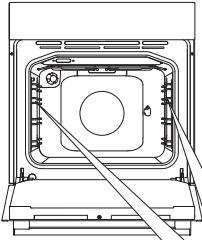

A Hold the guides by the bottom side and pull them towards the center of the oven cavity.

B Remove them from the openings at the top.

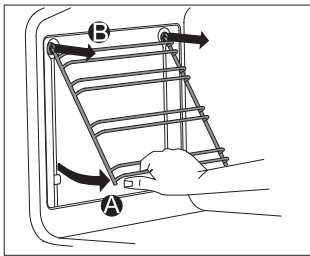

Do not clean the extendible guides in the dishwasher.

INSTALLING THE CATALYTIC INSERTS

Only use conventional cleaners to clean the guides.

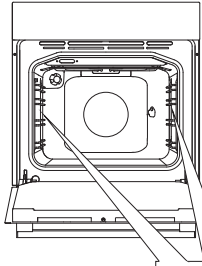

Remove the wire guides or extendible guides.

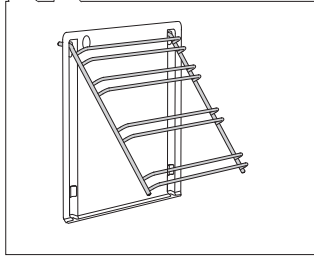

1 Mount the guides onto the catalytic insert.

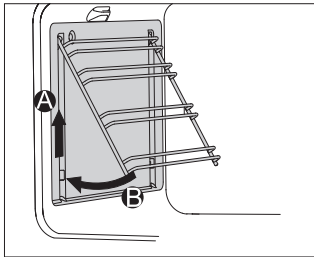

2 Hang the inserts with guides attached using the holes provided, and pull upwards.

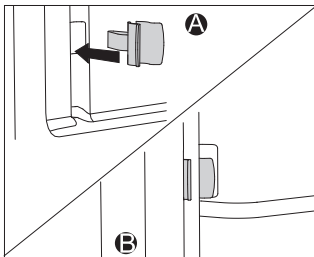

When installing fully extendible guides with catalytic inserts, insert one end of the supplied snap locks into the openings at the bottom of the oven cavity wall and insert the other end of the snap locks into the guides.

The purpose of the snap locks is to hold the guides in place more firmly.



Do not wash the catalytic inserts in the dishwasher.

CLEANING THE OVEN CAVITY CEILING

(depending on the model)

Upper grill heater is foldable to allow easier cleaning of the oven cavity ceiling. Before cleaning the oven, remove the trays, the grid, and the guides.

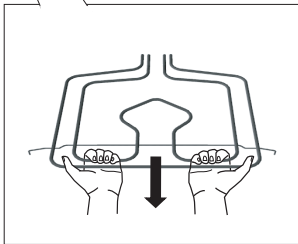
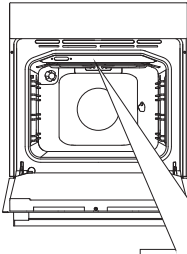

Pull the heater until the cross bar is released from the supports on the left and right hand side of the oven cavity.

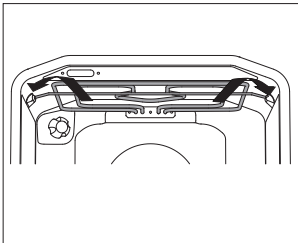

.....
 Never use the heater when folded/ lowered. After cleaning, observe the same procedure in the reverse order to push back the heater until the cross bar snaps back into place.

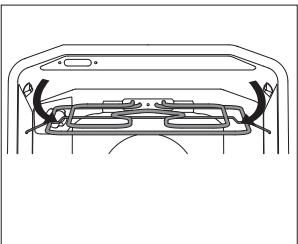

Disconnect the appliance from the power mains.

The heater must be cool; otherwise, there is danger of burns.

REMOVING AND INSERTING THE OVEN DOOR

(depending on the model)

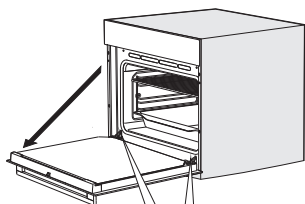

1 First, fully open the door (as far as it will go).

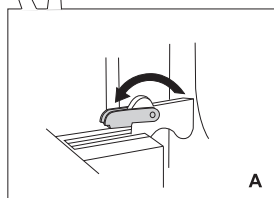

2 **A** Rotate the stoppers all the way back (in case of conventional closing).

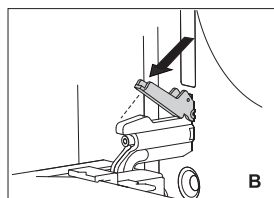

B If the appliance is fitted with the GentleClose system, flip the door latches back to a 90° angle (Figure 2).

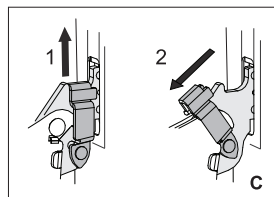

C If the appliance is fitted with the GentleClose system, slightly lift the door latches and pull them towards you.

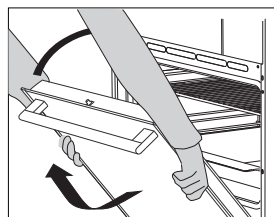

3 Slowly close the door until the latches are aligned with the slots. Slightly lift the door and pull it out from both hinge slots on the appliance.

To replace the door, observe the reverse order. If the door does not open or close properly, make sure the notches on the hinges are aligned with the hinge beds.



When replacing the door, always make sure the hinge retainers are correctly placed in the hinge beds to prevent sudden closing of the main hinge which is connected to a strong main spring. If the main spring is engaged, there is a risk of injury.

DOOR LOCK (depending on the model)

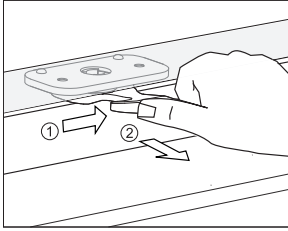

To open it, gently push it to the right with your thumb and pull the door outwards at the same time.

 **When the oven door is closed, the door lock automatically returns to the initial position.**

DEACTIVATING AND ACTIVATING THE DOOR LOCK

 **The oven should be cooled down completely.**

First, open the oven door.

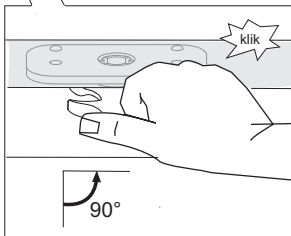
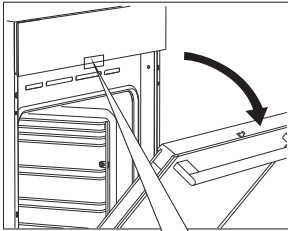

Push the door lock to the right by 90° with your thumb until you feel a click. The door lock is not deactivated.

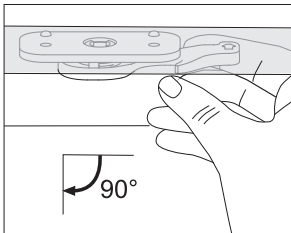

To reactivate the door lock, open the oven door and use your right-hand index finger to pull the lever towards you.

SOFT DOOR CLOSING (depending on the model)

Oven door is fitted with a system that dampens the door closing force, starting at the 75-degree angle. It allows simple, quiet, and smooth closing of the door. A gentle push (to a 15-degree angle relative to the closed door position) is enough for the door to close automatically and softly.



If the force applied to close the door is too strong, the effect of the system is reduced or the system will be bypassed for safety.

REMOVING AND INSERTING THE OVEN DOOR GLASS PANE

Oven door glass pane can be cleaned from the inside, but it has to be removed first. Remove the oven door (see chapter "Removing and replacing the oven door").

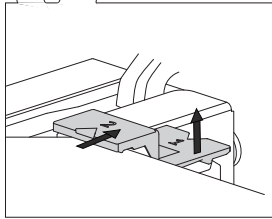
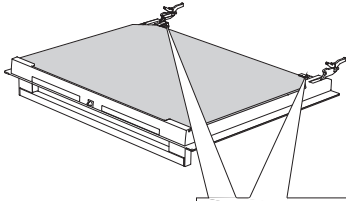

1 Slightly lift the supports on the left and right side of the door (marking 1 on the support) and pull them away from the glass pane (marking 2 on the support).

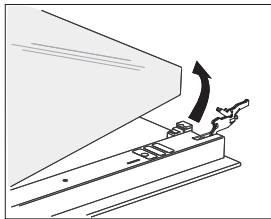

2 Hold the door glass pane by the lower edge; slightly lift it so that it is no longer attached to the support; and remove it.

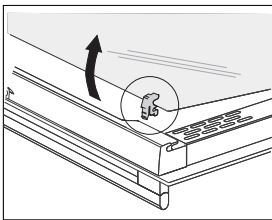

3 To remove the third glass pane (only with some models), lift and remove it. Also remove the rubber seals on the glass pane.



To replace the glass pane, observe the reverse order. The markings (semicircle) on the door and the glass pane should overlap.

REPLACING THE BULB

The bulb is a consumable and therefore not covered by warranty. Before changing the bulb, remove the trays, the grid, and the guides.

(Halogen lamp: G9, 230 V, 25 W; regular bulb E14 25W 230V)

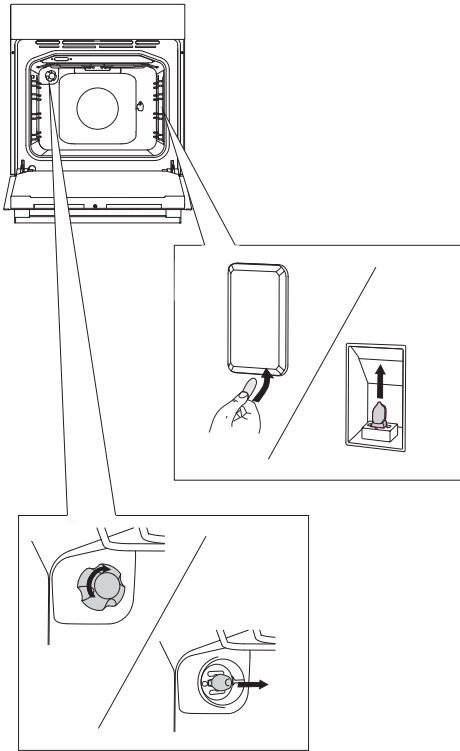

Use a flat screwdriver to release the bulb cover and remove it. Remove the bulb.

 Be careful not to damage the enamel.

Undo the bulb cover and remove the bulb.

 Use protection to avoid burns.

TROUBLESHOOTING TABLE

Problem/error	Solution
There is no response of the sensors; the display is frozen.	Disconnect the appliance from the power mains for a few minutes (undo the fuse or switch off the main switch); then, reconnect the appliance and switch it on.
The main fuse in your home trips often.	Call a service technician.
The oven lighting does not work.	The process of changing the light bulb is described in the chapter Cleaning and Maintenance.
The pastry is underdone.	Did you choose the right temperature and heating system? Is the oven door closed?
An error code is displayed (E1, E2, E3 etc.).	There is an error in the electronic module operation. Disconnect the appliance from the power mains for a few minutes. Then, reconnect it and set the time of day. If the error is still indicated, call a service technician.

If the problems persist despite observing the advice above, call an authorized service technician. Repair or any warranty claim resulting from incorrect connection or use of the appliance shall not be covered by the warranty. In this case, the user will cover the cost of repair.



Before the repair, disconnect the appliance from the power mains (by removing the fuse or by removing the plug from the wall outlet).

DISPOSAL



Packaging is made of environmentally friendly materials that can be recycled, disposed of, or destroyed without any hazard to the environment. To this end, packaging materials are labelled appropriately.

The symbol on the product or its packaging indicates that the product should not be treated as normal household waste. The product should be taken to an authorized collection center for waste electric and electronic equipment processing.

Correct disposal of the product will help prevent any negative effects on the environment and health of people which could occur in case of incorrect product removal. For detailed information on removal and processing of the product, please contact the relevant municipal body in charge of waste management, your waste disposal service, or the store where you bought the product.

We reserve the right to any changes and errors in the instructions for use.

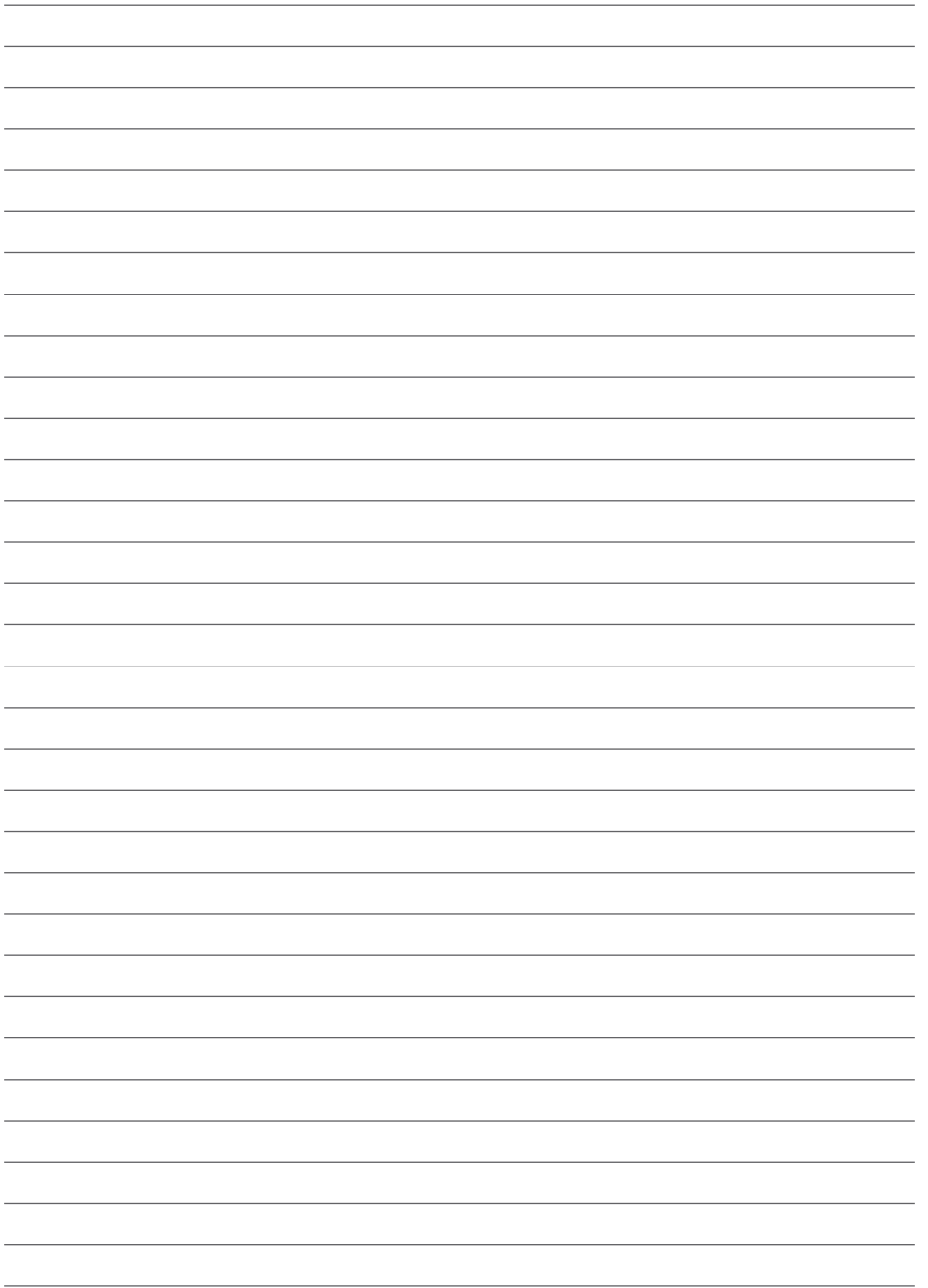

EVP_EPM1.2_KARIM



en (07-19)