

**gorenje**

EN

GB

IE

## **INSTRUCTIONS FOR USE**

Induction hob

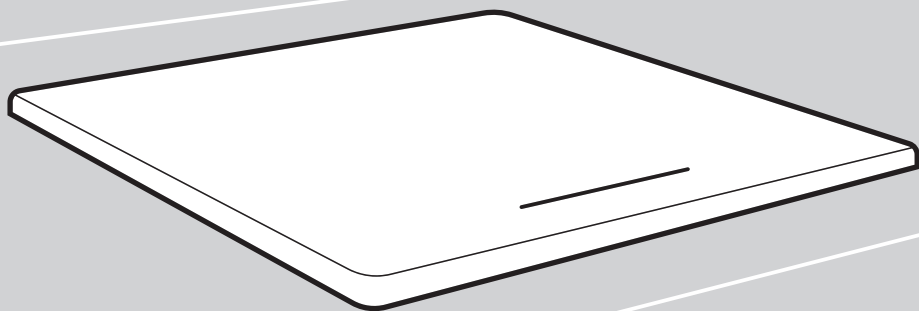

We thank you for your trust and the purchase of our appliance.

This detailed instruction manual is supplied to make the use of this product easier. The instructions should allow you to learn about your new appliance as quickly as possible.

Make sure you have received an undamaged appliance. If you do find transport damage, please contact the seller from which you purchased the appliance, or the regional warehouse from which it was supplied. The telephone number can be found on the invoice or on the delivery note.

Instructions for use are also available at our website:

[www.gorenje.com](http://www.gorenje.com) / < <http://www.gorenje.com> />



**INFORMATION!**

Information, advice, tip, or recommendation



**WARNING!**

Warning – general danger

# Contents

|   |           |
|---|-----------|
| <b>Safety precautions</b> .....                 | <b>4</b>  |
| <b>Other important safety warnings</b> .....    | <b>7</b>  |
| Before connecting the appliance .....           | 7         |
| <b>Appliance description</b> .....              | <b>8</b>  |
| Technical data .....                            | 8         |
| Before first use .....                          | 8         |
| Hob .....                                       | 9         |
| <b>Operating the cooking hob</b> .....          | <b>12</b> |
| Control unit .....                              | 12        |
| Switching on the hob .....                      | 12        |
| Switching on the cooking zones .....            | 13        |
| Changing the cooking zone settings .....        | 13        |
| Power Boost .....                               | 13        |
| Child lock / lock .....                         | 14        |
| Time functions .....                            | 14        |
| Switching off the cooking zone .....            | 15        |
| Maximum cooking time .....                      | 15        |
| Residual heat indicator .....                   | 15        |
| Switching off the entire cooking hob .....      | 15        |
| Automatic switch off .....                      | 16        |
| <b>Cleaning and maintenance</b> .....           | <b>17</b> |
| <b>Troubleshooting table</b> .....              | <b>18</b> |
| Noises during induction cooking .....           | 19        |
| <b>Installing a built-in hob</b> .....          | <b>20</b> |
| Installation procedure .....                    | 20        |
| Air vents in the lower kitchen cabinet .....    | 21        |
| Flush-mount installation into the worktop ..... | 22        |
| Fitting the foam gasket .....                   | 25        |
| <b>Connection diagram</b> .....                 | <b>26</b> |
| Connecting the appliance 60 cm .....            | 26        |
| Power cord .....                                | 26        |
| Connecting the power cord .....                 | 27        |
| <b>Disposal</b> .....                           | <b>28</b> |

## Safety precautions



### **IMPORTANT SAFETY PRECAUTIONS – CAREFULLY READ THE INSTRUCTIONS AND SAVE THEM FOR FUTURE REFERENCE.**

This appliance can be used by children aged from 8 years and above and persons with reduced physical, sensory or mental capabilities or lack of experience and knowledge if they have been given supervision or instruction concerning use of the appliance in a safe way and understand the hazards involved. Children shall not play with the appliance. Cleaning and user maintenance shall not be made by children without supervision.

**WARNING:** The appliance and its accessible parts become hot during use. Care should be taken to avoid touching heating elements.

Children less than 8 years of age shall be kept away unless continuously supervised.

Do not use steam cleaners or high-pressure cleaners to clean the appliance, as this may result in an electric shock.

The appliance is not intended to be controlled by external timers or separate remote control system.

Means for disconnection must be incorporated in the fixed wiring in accordance with the wiring rules.

If the supply cord is damaged, it must be replaced by the manufacturer, its service agent or similarly qualified persons in order to avoid a hazard (only for appliances supplied with connection cord).

**WARNING:** If the surface is cracked, switch off the appliance to avoid the possibility of electric shock. Switch off all cooking zones using their respective controls and remove the fuse or trip the main circuit breaker so that the appliance is fully isolated from the power mains.

**WARNING:** Unattended cooking on a hob with fat or oil can be dangerous and may result in fire. NEVER try to extinguish a fire with water, but switch off the appliance and then cover flame e.g. with a lid or a fire proof blanket.

**WARNING:** Danger of fire: do not store items on the cooking surfaces.

**CAUTION:** The cooking process has to be supervised. A short term cooking process has to be supervised continuously.

**CAUTION:** This appliance is for cooking purposes only. It must not be used for other purposes, for example room heating.

**WARNING:** Use only hob guards designed by the manufacturer of the cooking appliance or indicated by the manufacturer of the appliance in the instructions for use as suitable or hob guards incorporated in the appliance. The use of inappropriate guards can cause accidents.

Metalic objects such as knives, forks, spoons and lids should not be placed on the hob surface since they can get hot.

After use, switch off the hob element by its control and do not rely on the pan detector.

Appliance must be connected to fixed wiring which has incorporated means of disconnection. Fixed wiring must be made in accordance with the wiring rules.

## Other important safety warnings

The appliance is intended for household use. Do not use it for any other purpose, such as room heating, drying of pets or other animals, paper, fabrics, herbs etc. As this may lead to injury or fire hazard.

Appliance must be connected to fixed wiring which has incorporated means of disconnection. Fixed wiring must be made in accordance with the wiring rules.

If another electrical appliance is connected to an AC power socket near the appliance, make sure the power cord does not come in to contact with hot cooking zones.

If the power cord is damaged, it should be replaced by the manufacturer or an authorised service technician, in order to avoid hazard.

Using the glass ceramic hob as a storage area may result in scratches or other damage to it. Never heat food in aluminium foil or in plastic containers on the cooking hob. Such foil or containers may melt which can result in a fire or damage to the cooking hob.

Do not store temperature-sensitive items underneath the appliance, such as cleaners or detergents, spray cans etc.

Eventual mismatches in colour shades between different appliances or components within a single design line may occur due to various factors, such as different angles under which the appliances are observed, different coloured backgrounds, materials, and room illumination.

## Before connecting the appliance



### **WARNING!**

**Carefully read the instructions for use before connecting the appliance. Repair or any warranty claim resulting from incorrect connection or use of the appliance shall not be covered by the warranty.**

# Appliance description



## INFORMATION!

Appliance functions and equipment depend on the model.

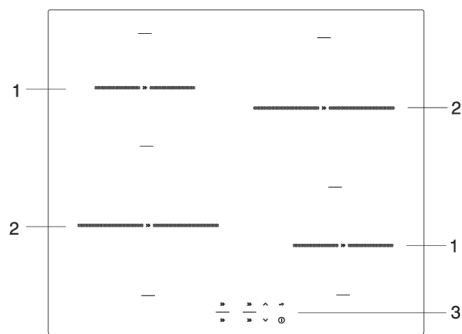

1. Induction cooking zone  $\varnothing$  90 mm
2. Induction cooking zone  $\varnothing$  130 mm
3. Cooking hob control module

## Technical data

(depending on the model)



- A. Serial number
- B. Code
- C. Type
- D. Trademark
- E. Model
- F. Technical data
- G. Compliance indications / symbols

**The rating plate with basic information on the appliance is located on the bottom side of the cooking hob. Information on appliance type and model can be found on the warranty sheet.**

## Before first use

If your hob has a **glass ceramic** surface, clean it with a damp cloth and some washing-up liquid. Do not use aggressive cleaners, such as abrasive cleaners that could cause scratches, abrasive dishwashing sponges, or stain removers.

During initial use, characteristic "new appliance smell" may appear; it will gradually disappear.



# Hob

## Glass ceramic cooking surface

- The hob is resistant to temperature changes.
- Do not use the glass ceramic hob if it is cracked or broken. If a sharp object falls on the hob, the hob may break. The consequences of such occurrence may be visible immediately or only after a while.
- If any visible crack appears in the hob, immediately cut off the power supply to the appliance.
- Make sure the cooking zone and the cookware bottom is clean and dry. This will allow better conduction of heat and prevent any damage to the heating surface.
- Do not place empty cookware on the cooking zone. The cooking zone may be damaged if you place an empty pan onto it. Before placing a pan onto the cooking zone, wipe the pan bottom dry to allow conduction of heat.

## Cooking power levels

Cooking zone heating power can be set to 10 different levels (depending on the model). The table lists some examples of use for each level.

| Cooking power level | Purpose  |
|---------------------|--|
| 0                   | switched off , using the residual heat   |
| 1 - 2               | keeping the food warm, slow cooking of smaller amounts (lowest setting)                            |
| 3                   | slow cooking (follow-up cooking after the initial power boost)                                     |
| 4 - 5               | slow cooking (follow-up cooking) of large amounts, pan-roasting of larger chunks                   |
| 6                   | searing and browning   |
| 7 - 8               | searing  |
| 9                   | cooking of large amounts, searing  |
| P                   | Power Boost setting for start of the cooking process; also suitable for very large amounts of food |

## Energy saving tips

- When purchasing cookware, note that the diameter indicated on the pan usually pertains to the upper edge or the lid, which is normally larger than the diameter of the pan bottom.
- If a dish takes a long time to cook, use a pressure cooker. Make sure there is always sufficient liquid in the pressure cooker. If an empty cooker is placed on the cooking hob, it may overheat which in turn may lead to damage to both the pot and the cooking zone.
- Whenever possible, close the pot or pan with a suitably sized lid. Use cookware that fits the amount of food you are cooking. Cooking in a large partly full pot will consume much more energy.

## Induction cooking zone operating principle

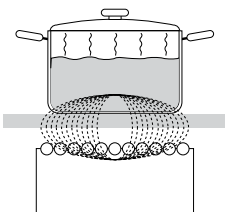

- The cooking hob is fitted with highly efficient induction cooking zones. The heat is generated directly in the bottom of the pan where it is needed the most. This avoids any losses through the glass ceramic surface. Power consumption is considerably lower than in conventional cooking zones with radiation heaters.
- The glass ceramic cooking zone is not heated directly, but only indirectly with the heat radiated back by the pan. After the cooking zone is switched off, this residual heat is indicated by "H".

- In induction cooking zones, heating is made possible by the induction coil installed under the glass ceramic surface. The coil induces a magnetic field which generates eddy currents in the bottom of a ferromagnetic pan, which in turn heats the pan.

### **WARNING!**

If sugar or food with high sugar content is spilled over a hot class ceramic hob, immediately wipe the hob or remove the sugar with a scraper, even if the cooking zone is still hot. This will prevent any damage to the class ceramic surface.

Do not use detergents and other cleaners to clean a hot glass ceramic hob as this could damage the surface.

### **Pan recognition**

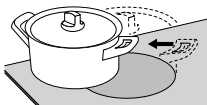
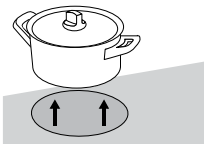

- Even if there is no pot or pan on the cooking zone or if the pan used has a diameter that is smaller than the diameter of the cooking zone, there will be no losses of energy.
- If the pan is much smaller than the cooking zone, there is a possibility that it will not be recognized by the cooking zone. When the cooking zone is activated, the sign  and the selected power level will flash alternately on the cooking power display.
- If a smaller pan or pot is placed on the cooking zone and it is recognized, the hob will only use as much power as necessary given the pan size.

### **Induction cookware**

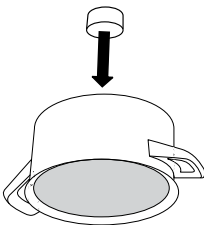

- The induction will work correctly if you use suitable cookware.
  - Make sure the pot or pan is in the middle of the cooking zone
  - Suitable cookware: cookware made of steel, enamel-coated steel pans, or cast iron pans.
  - Unsuitable cookware: alloy steel cookware with copper or aluminium bottom, and glass cookware.
  - The magnet test: Use a small magnet to check whether the pan or pot bottom is ferromagnetic. If the magnet sticks to the bottom of the pan, then it is suitable for an induction cooker.
- When using a pressure cooker, keep an eye on it until the right pressure is reached. First, set the cooking zone to maximum power; then, following the pressure cooker manufacturer's instructions, decrease the cooking power when appropriate.

- Make sure there is enough liquid in the pressure cooker, or any other pot or pan. Due to overheating, using an empty pot on the cooking zone may result in damage to both the pot and the cooking zone.
- Some cookware does not have a fully ferromagnetic bottom. In such case, only the magnetic part will heat up, while the rest of the bottom will remain cool.
- When using special cookware, observe the manufacturer's instructions.
- For best cooking results, the ferromagnetic area on the cookware bottom should match the size of the cooking zone. If the cooking zone does not recognize the pan, try placing it on a different cooking zone with a smaller diameter.

| Cooking zone                        | Minimum pan bottom diameter |
|-------------------------------------|-----------------------------|
| Rear left, front right              | Ø 90 mm                     |
| . Induction cooking zone rear right | Ø 130 mm                    |

Pan bottom has to be flat.

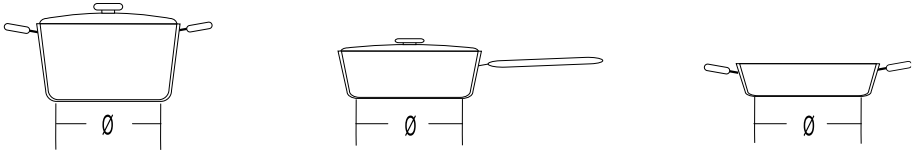

# Operating the cooking hob

## Control unit

(depending on the model)

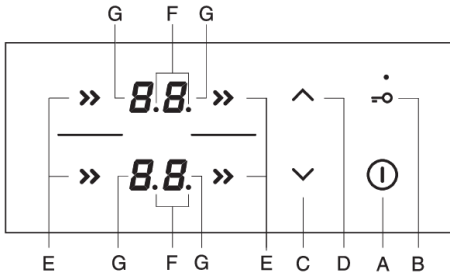

A Hob on/off key

B Lock/child lock

C Power and timer decrease key

D Power and timer increase key

E Cooking zone on key

F Decimal point indicating that timer function is activated

G Power level displays

## Switching on the hob

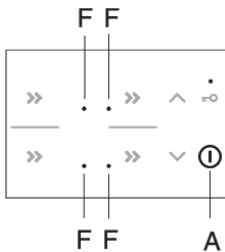

Touch the on/off key (A) and hold it for 1 second to switch on the hob. An acoustic signal will be sounded and the decimal point will light up on all display units.



### INFORMATION!

If no cooking zone is switched on in 10 seconds, the cooking hob will power off.



### INFORMATION!

When the appliance is first connected to the power mains or re-connected after a power supply failure, the appliance is locked.

## Switching on the cooking zones

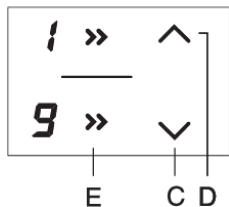

After the hob is switched on (in the next 10 seconds), switch on the desired cooking zone (E). Use the keys C and D to select the desired setting for the activated cooking zone. If you first touch the C key, the power level will be set to "9". If you first touch the D key, the power level will be set to "1".

If there is no cookware on the selected cooking zone, the set power level and the symbol  will appear alternately on the display unit.

## Changing the cooking zone settings

Power level can be changed at any time by selected the desired cooking zone a,d adjusting the setting by touching the corresponding key C or D.

To increase or decrease the power level faster, touch and hold the C or D key.

## Power Boost

(depending on the model)

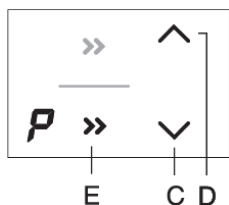

Select any cooking zone. Touch the (C) key. A short acoustic signal will be emitted and "9" will appear on the display unit. Touch the D key and P will appear on the display unit. The cooking zone will operate at maximum power for 10 minutes; then, an acoustic signal will be emitted and the power level will switch to 9.

## Deactivating the Power Boost

Power can be decreased to desired level by pressing the (C) key.



### INFORMATION!

The cooking zone with the power boost function activated is highly powerful.

## Child lock / lock

Child lock may be activated on the hob to prevent the appliance from being switched on easily and quickly and to prevent any changes during operation.

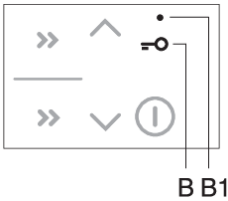

### Locking the cooking hob controls

Touch the lock/child lock key (B) and hold it for 1 second. Signal light (B1) will light up. The cooking hob is now locked.

### Unlocking the cooking hob controls

To unlock the cooking hob, proceed in the same way as for locking it. The hob must be switched off. Touch the B key and hold it for 1 second.

### INFORMATION!

The lock function can be activated when the cooking zones are switched on or when the cooking zone is switched off. If the cooking zone is switched on, the key lock function locks all keys, except for the cooking zone on/off key (A) and the lock key.

If the cooking zone is switched off, the key lock function locks all keys, except for the lock key. Cooking hob lock is always activated when the appliance is connected to the power mains or after the power supply has been disconnected.

## Time functions

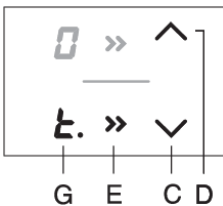

This function allows setting the cooking time for the selected cooking zone on which a power level has already been set. When the time expires, the cooking zone is switched off automatically.

Cooking time can be set from 1 to 99 minutes. The program timer can be set for all cooking zones at all power levels.

### Timer activation

First, select the cooking zone (E). Then, use the (C) and (D) keys to set the power level. The program timer will not operate if the power level is set to "0". Touch the cooking zone selection key (E) again. An acoustic signal will be emitted, and "t." with a decimal point will appear on the cooking zone display unit (G). Remaining time will appear on the opposite cooking zone display.

- Touch the (C) and (D) keys to set the time from 1 to 99 minutes.
- When the desired value is set, the countdown begins. If you touch the (C) and (D) keys simultaneously, the time will be reset to »0« or it will be switched off. If you touch and hold the (C) or (D) key, the rate at which the setting changes will increase.
- After a few seconds, timer display will switch off and a decimal point will be lit next to the power display.

- After the set time has expired, acoustic signal will be activated and the cooking zone will be switched off. Switch of the alarm by touching any key; alternatively, it will switch off automatically after 2 minutes.

### Changing the cooking time

- Remaining cooking time can be changed at any time during cooking.
- Press the key for the desired cooking zone twice.
- Touch the (C) or (D) key to set a new desired cooking time.

### Displaying the remaining cooking time

If several timer settings are activated, remaining cooking time can be displayed by touching the (E) key twice.

## Switching off the cooking zone

To switch off a cooking zone (E), use the relevant (C) key to set the power level to "0". To quickly switch off the cooking zone, touch the relevant (C) and (D) keys simultaneously. You will hear a short beep, and "0" will be displayed on the display unit.



### INFORMATION!

If the power of all all cooking zones is set to "0", the cooking zone will switch off automatically after a few seconds.

## Maximum cooking time

For safety, the cooking time for each cooking zone is restricted to a maximum duration. Maximum cooking time depends on the most recently set power level. If the power level is not changed, the cooking zone will be switched off automatically after the maximum cooking duration is reached.

| Cooking power level            | 1  | 2  | 3  | 4  | 5  | 6  | 7  | 8  | 9 |
|--------------------------------|----|----|----|----|----|----|----|----|---|
| Maximum operating time (hours) | 10 | 10 | 10 | 10 | 10 | 10 | 10 | 10 | 3 |

\* After 10 minutes, the power level automatically decreases to 9; after 1.5 hours, the cooking zone is switched off.

## Residual heat indicator

The glass ceramic hob is also fitted with a residual heat display, "H". The glass ceramic cooking zone is not heated directly, but only indirectly by the heat radiated back by the pan. As long as the symbol "H" is lit up after the hob has been switched off, there is residual heat in the cooking zone, which can be used to keep the food warm or for defrosting. When the "H" sign disappears, the cooking zone may still be hot. Be careful as there is danger of burns!

## Switching off the entire cooking hob

The cooking hob can be switched off at any time by touching the on/off key.

## **Automatic switch off**

If the keys are activated for too long during cooking (e.g. due to spilt liquid or an object placed over the sensor keys), the cooking hob will be switched off after 10 seconds. – will flash on all displays and an acoustic signal will be emitted.

The acoustic signal will stop when you remove the object or wipe the spilt liquid.



# Cleaning and maintenance

After each use, wait for the glass ceramic surface to cool down and clean it. Otherwise, all remaining impurities will burn onto the hot surface the next time you use the hob.

For regular maintenance of the glass ceramic hob, use special care products that create a protective film on the surface to prevent the dirt from sticking onto it.

Before each use of the glass ceramic surface, wipe off the dust or any other impurities that could scratch the surface, from both the hob and the pan bottom.

## **INFORMATION!**

Steel wool, coarse cleaning sponges, and abrasive powders may scratch the surface. The surface may also be damaged by aggressive spray cleaners and unsuitable liquid cleaners.

Signage may be worn when using aggressive or abrasive cleaners or cookware with coarse or damaged bottom.

Use a damp soft cloth to remove minor impurities. Then, wipe the surface dry.

Remove water stains with a mild solution of vinegar. However, do not use this solution to wipe the frame (only with some models) as it may lose its sheen. Do not use aggressive spray cleaners or descaling agents.

Use special glass ceramic cleaners for stubborn dirt. Observe the manufacturer's instructions. Be sure to thoroughly remove any cleaner residues after the cleaning process as they may damage the glass ceramic surface when the cooking zones heat up.

Remove stubborn and burnt residues with a scraper. Be careful when handling the scraper to prevent injury.

## **INFORMATION!**

The scraper is not included in appliance equipment.

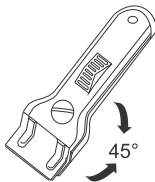

## **INFORMATION!**

Only use the scraper when dirt cannot be removed with a wet cloth or special cleaners for glass ceramic surfaces.

Hold the scraper at the correct angle (45° to 60°). Gently press the scraper against the glass and slide it over the signage to remove the dirt. Make sure the plastic handle of the scraper (in some models) does not come into contact with a hot cooking zone.

## **INFORMATION!**

**Do not press the scraper perpendicularly against the glass and do not scratch the hob surface with its tip or blade.**

Immediately remove any sugar or sugar-laden food from the glass ceramic hob using a scraper, even if the hob is still hot, as sugar may permanently damage the glass ceramic surface.

# Troubleshooting table

**During the warranty period, only a service center authorized by the manufacturer may carry out any repairs.**

Before making any repairs, make sure the appliance is disconnected from the power mains either by removing the fuse or by disconnecting the power plug from the wall outlet.

Any unauthorized repairs of the appliance may result in electric shock and short circuit hazard; therefore, do not perform them. Leave such work to an expert or a service technician.

In case of minor problems with appliance operation, check this manual to see if you can fix the problem yourself.

If the appliance is not operating properly or at all due to inappropriate operation or handling, a visit from a service technician shall not be free of charge, even during the warranty period.

Save the instructions for future reference and pass them on to any subsequent owners or users of the appliance.

Following is some advice on rectifying some common problems.

| <b>Problem/error</b>                           | <b>Cause</b>  |
|--|---|
| <b>The main fuse in your home trips often.</b> | Call a service technician.  |
| <b>Continuous beep and display –</b>           | Water spilt over sensor surface, or an object placed over the sensors.<br>Wipe the sensor surface.                                  |
| <b>"C" on the display</b>                      | Cooking zone has overheated.<br>Wait for the cooking zone to cool down.   |
| <b>"r" on the display</b>                      | This indicates that the desired power level cannot be set because the limit for maximum total cooking hob power has been activated. |
| <b>"F" on the display</b>                      | This indicates that there has been an error during operation.   |

If the problems persist despite observing the above advice, call an authorized service technician. Repair or any warranty claim resulting from incorrect connection or use of the appliance shall not be covered by the warranty. In this case, the user will cover the cost of repair.



## **WARNING!**

Before the repair, disconnect the appliance from the power mains (by removing the fuse or by removing the plug from the wall outlet).

## Noises during induction cooking

| Noises and sounds                              | Cause   | Solution  |
|--|---|---|
| <b>Inductiongenerated operating noise</b>      | Induction technology is based on the properties of some metals under electromagnetic effect. It results in so-called eddy currents that force the molecules to oscillate. These oscillations (vibrations) are transformed into heat. Depending on the type of metal, this could result in quiet noises. | This is normal and it is not a result of any malfunction.   |
| <b>Transformer-like buzz</b>                   | Occurs when cooking at a high power level. The reason for this is the amount of energy transferred from the cooking hob to the pot or pan.  | This noise will disappear or weaken when you reduce the power level.  |
| <b>Vibration and crackling of the cookware</b> | This noise appears in cookware (pots or pans) made of different materials.  | It results from vibrations along the adjacent surfaces of different material layers. This noise depends on the cookware. It can vary depending on the amount and type of food being cooked. |
| <b>Fan noise</b>                               | Correct operation of induction electronic components requires temperature control. Therefore, the cooking hob is fitted with a fan that cools the electronics depending on the sensed temperature.  | The fan may operate even after the cooking hob has been switched off, if the temperature remains too high.  |

# Installing a built-in hob

## Installation procedure

- The worktop has to be completely level.
- Suitably protect the edges of the cut aperture.
- Connect the cooking hob to the mains power supply (see instructions for the connection of the cooking hob to mains power supply).
- Insert the hob into the cut aperture.

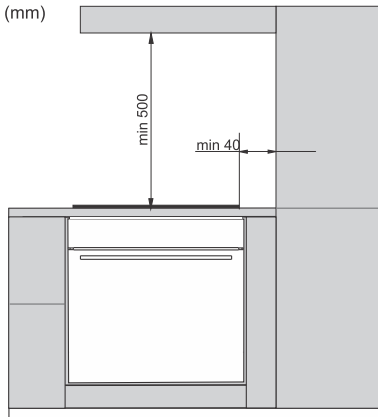

- Installation of the appliance into a kitchen worktop and its connection to the power mains may only be performed by an adequately qualified technician.
  - Veneer or other finish of the piece of kitchen furniture into which the hob is to be built in should be treated with heat resistant glue (100°C); otherwise, the worktop finish may be discolored or deformed.
  - Use of solid wood corner trims on worktops behind the cooking hob is only allowed if the clearance between the trim and the cooking hob is no smaller than indicated on the installation plans.
  - Cooking hob is dimensioned to be built into the worktop over a piece of kitchen furniture, with a width of 600 mm or more.
- 
- Hanging, or wall-mounted kitchen elements should be installed high enough not to interfere with the work process.
  - The distance between the cooking hob and the kitchen hood should be no less than indicated in the instructions for kitchen hood installation. The minimum distance is 500 mm.
  - The distance between the appliance edge and the adjacent tall kitchen furniture element should amount to no less than 40 mm.
  - Use of solid wood corner trims on worktops behind the cooking hob is only allowed if the clearance between the trim and the cooking hob is no smaller than indicated on the installation plans.
  - Minimum distance between the built-in cooking hob and the rear wall is indicated on the installation drawing.

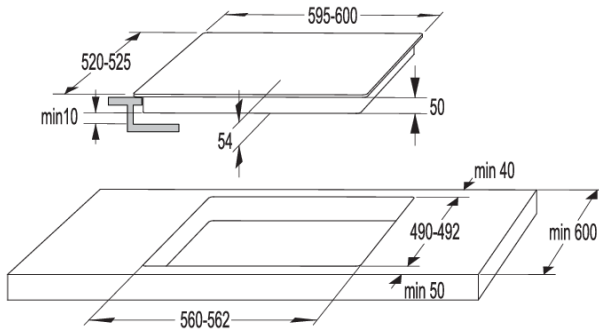

## Air vents in the lower kitchen cabinet



### INFORMATION!

Normal operation of the induction cooking hob electronic components requires sufficient air circulation.

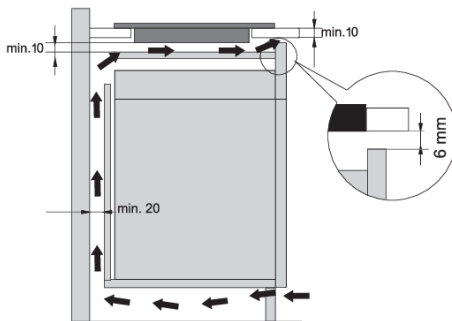

### Lower cabinet with a drawer

- There must be an opening with a height of no less than 140 mm along the entire width of the cabinet in the cabinet rear wall. In addition, there should be an opening of at least 6 mm in the front side, along the entire width of the cupboard.
  - A horizontal partition panel should be installed underneath the cooking hob along its entire length. There should be at least 10 mm of clearance between the lower end of the appliance and the partition panel. Adequate ventilation should be allowed from the rear side.
- The hob is fitted with a fan located in its lower part. If there is a drawer below the kitchen cabinet, do not use it to store small objects or paper as these could, if sucked into the fan, damage the fan and the cooling system. Moreover, do not use the drawer to store aluminium foil or flammable substances or liquids (such as sprays). Keep such substances away from the cooking hob. Danger of explosion!
  - There should be at least 20 mm of clearance between the contents of the drawer and the fan inlet vents.

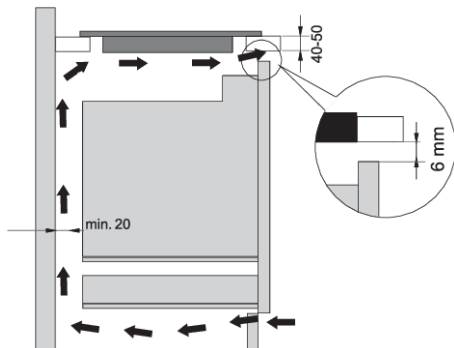

### Lower cabinet with an oven

- Installing an oven under the induction hob is possible for oven types with a cooling fan.
- Before installing the oven, the kitchen cabinet rear wall has to be removed in the area of the opening for installation.
- In addition, there should be an opening of at least 6 mm on the front side, along the entire width of the cabinet.
- If other appliances are installed under the induction cooking hob we cannot guarantee their correct operation.

## Flush-mount installation into the worktop

Appliances without faceted edges or decorative frames, are suitable for flush mounting.



## Installing the appliance

The appliance may only be installed into a temperature- and water-resistant countertop, such as a countertop made of (natural) stone (marble, granite), or solid wood (the edges along the cut-out have to be sealed). When installing into a countertop made of ceramics, wood, or glass, a wooden sub-frame should be used. The frame is not supplied with the appliance. The appliance may only be installed into a countertop made of other materials after you have consulted the countertop manufacturer and obtained his express approval. Internal dimension of the basic unit should be at least equal to the internal cutout for the appliance. This will allow simple removal of the appliance from the countertop. Attach sealing tape along the perimeter of the bottom of the glass panel.

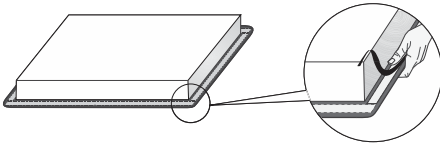

First, feed the power cord through the cutout. Place the appliance over the centre of the cutout. Connect the appliance to the power mains (see instructions for connecting the appliance). Before sealing the appliance, test its operation. Seal the slot between the appliance and the countertop using a silicone sealant. The silicone sealant used to seal the appliance has to be temperature-resistant (to at least 160 °C). Smooth out the silicone sealant using a suitable tool. Observe the instructions for use of the selected silicone sealant. Do not switch on the appliance until the silicone sealant has dried completely.

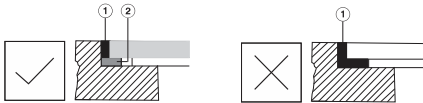

1. Silicone sealant
2. Sealing tape

### **⚠ WARNING!**

Pay particular attention to built-in dimensions with (natural) stone countertops. When choosing the silicone sealant, observe the countertop material and consult the countertop manufacturer. Use of inappropriate silicone sealants can result in permanent discolouration of some parts.

## Removing the built-in appliance

Disconnect the appliance from the power mains. Use a suitable tool to remove the silicone gasket from the perimeter. Remove the appliance by pushing it upwards from the bottom side.

### **⚠ WARNING!**

Do not attempt to remove the appliance from the upper side of countertop.

### **⚠ WARNING!**

The service department shall only be responsible for repair and servicing of the cooking hob. Consult your specialized kitchen equipment dealer regarding the re-installation (of the flush-mount) cooking hob.

**Stone countertop**

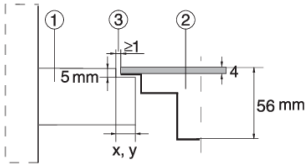

1. Countertop
2. Appliance
3. Slot

Given the margin of error (tolerance) for the glass ceramic plate of the appliance, and the cutout in the countertop, the slot is adjustable (min.2 mm).

**Ceramic, wooden, or glass countertop**

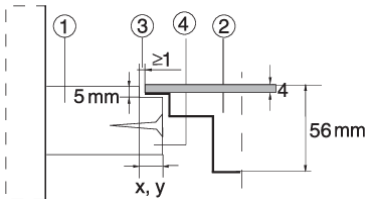

1. Countertop
2. Appliance
3. Slot
4. Wooden frame, thickness 16 mm

Given the margin of error (tolerance) for the glass ceramic plate of the appliance, and the cut-out in the countertop, the slot is adjustable (min. 2mm). Install the wooden frame 5.5mm below the upper edge of the countertop (see figure).

Observe the radii of glass edges (R10, R2) when making the cut-out.

GLASS

CUT-OUT

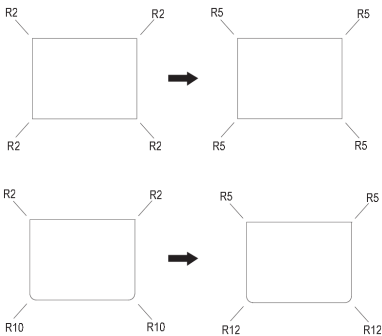



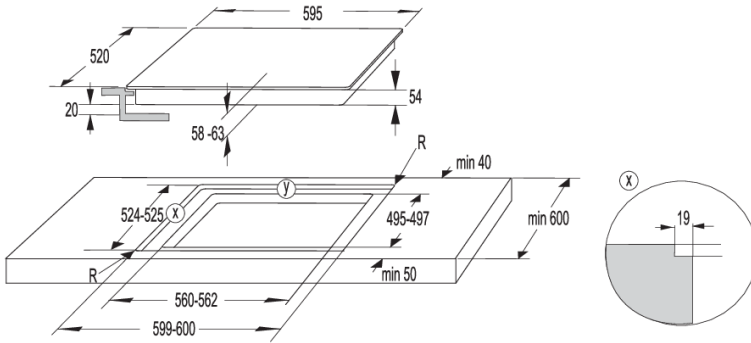

**⚠ WARNING!**

If the oven is installed under a flush-mounted cooking hob, then the worktop thickness should be at least 45 mm.

## Fitting the foam gasket

**💡 INFORMATION!**

Some appliances come with the gasket already fitted!

Before installing the appliance into a kitchen worktop, attach the foam gasket supplied with the appliance to the bottom side of the glass ceramic hob. Remove the protective film from the gasket. Attach the gasket to the bottom side of the glass (2–3 mm away from the edge). The gasket has to be applied along the entire edge of the glass. The gasket may not overlap in the corners. When fitting the gasket, make sure it is not damaged by or in contact with any sharp objects.

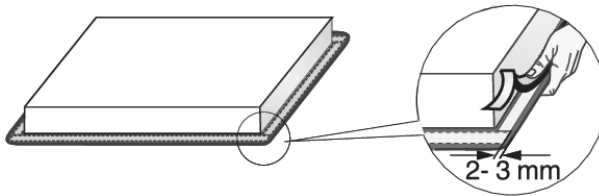

**⚠ WARNING!**

Do not install the appliance without the gasket!

# Connection diagram

## Connecting the appliance 60 cm

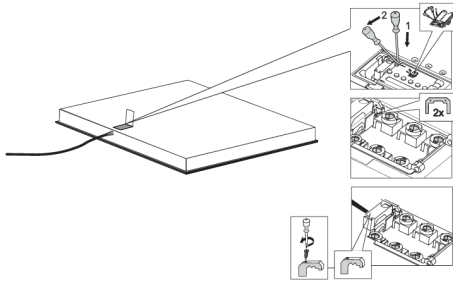

1. Check the voltage. Before connecting the appliance, make sure the voltage specified on the rating plate conforms to the voltage of your power mains. The voltage of your power mains (220–240 V between L and N) should be checked by an expert using an appropriate measuring device.
2. Open the cover of the connection terminal box.
3. Connect the wires according to your type of appliance.
4. The jumpers are provided on the connection terminal.

## Power cord

(appliance without a power cord)

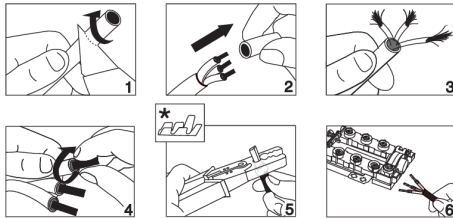

- The following may be used for connection:
- PVC insulated connection cables type H05 VV-F or H05V2V2-F with yellow-and-green protective conductor, or other equivalent or superior cables.
- Exterior cable diameter should be at least 8.00 mm.
- Run the power cord through a cord strain relief (clamp) which

\* Ferrules are not supplied.



### INFORMATION!

We recommend using electric wire ferrules (end terminals).

## Connection diagram

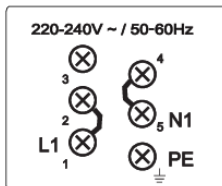

### Single phase connection (32 A)

- Single-phase connection (1 N, 220–240 V~ /50–60 Hz):
  - Voltage between line and neutral conductor is 220–240 V~. Install a jumper between terminals 1 and 2, and between terminals 4 and 5.
  - The circuit should be fitted with a fuse of at least 32 A. Power cord core cross-sectional area should be at least 4 mm<sup>2</sup>.

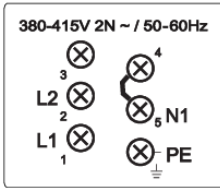

## 2-phase connection (16A)

- 2 phases, 1 neutral conductor (2 1N, 380–415 V~ /50–60 Hz):
  - Voltage between the line and neutral conductor is 220–240 V~.; voltage between lines is 380–415 V~. Install a jumper between the terminals 4 and 5. The circuit should be fitted with at least two fuses of at least 16 A each. Power cord core cross-sectional area should be at least 1.5 mm<sup>2</sup>.

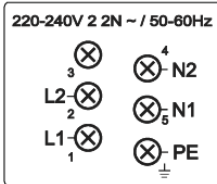

- 2 phases, 2 neutral conductors (2 2N, 220–240 V 2 2N ~ /50–60Hz):
  - Voltage between phases and neutral conductor is 220-240 V~.
  - The circuit should be fitted with at least two fuses of at least 16 A each. Power cord core cross-sectional area should be at least 1.5 mm<sup>2</sup>.

## Connecting the power cord

(appliance with a power cord)

- The appliance has to be hard-wired directly to the power mains.
- Devices for disconnecting from the power mains have to comply with the relevant regulations.
- Do not extend the power cord and do not lead it over sharp edges.
- If the appliance is installed above an oven, make sure the power cord is never in contact with the oven's hot parts.

| Single-phase connection                         | Two-phase connection                               |  |   |
|---|--|--|---|
| <p>1 x 32 A<br/>220-240 V 50-60 Hz</p> <p>A</p> | <p>2N 2 x 16 A<br/>380-415 V 50-60 Hz</p> <p>B</p> | <p>2 2N 2 x 16 A<br/>220-240 V 50-60 Hz</p> <p>C</p> | <p>L, L1 = brown<br/>L2 = black<br/>N, N1 = grey<br/>⊕ = yellow and green</p> |

| Single-phase connection  | Two-phase connection   |  |
|--|--|--|
| <p>Single-phase connection<br/>Connect the appliance as shown in Diagram A. If your power mains do not allow a 32 A fuse, the appliance power should be decreased or limited accordingly. See chapter User Settings.</p> | <p>If your electric mains have 2 line conductors and 1 neutral conductor, connect the appliance as shown in Diagram B.</p> | <p>If your electric mains have 2 line conductors and 2 neutral conductors, connect the appliance as shown in Diagram C.<br/><b>only for NLI!</b></p> |

# Disposal



Our product packaging is made of environmentally friendly materials that can be recycled, disposed of, or destroyed without any hazard to the environment. To this end, packaging materials are labelled appropriately.

**The symbol** on the product or its packaging indicates that the product should not be treated as normal household waste. Take the product to an authorized collection centre for waste electric and electronic equipment processing.

Correct **disposal** of the product will help prevent any negative effects on the environment and health of people, which could occur in case of incorrect product removal. For detailed information on removal and processing of the product, please contact the relevant municipal body in charge of waste management, your waste disposal service, or the store where you bought the product.

We reserve the right to any changes and errors in the instructions for use.

**gorenje**



718031-a3

