

TCM 200 - 300

NAVODILO ZA UPORABO

SI

INSTRUCTIONS FOR USE

EN

gorenje

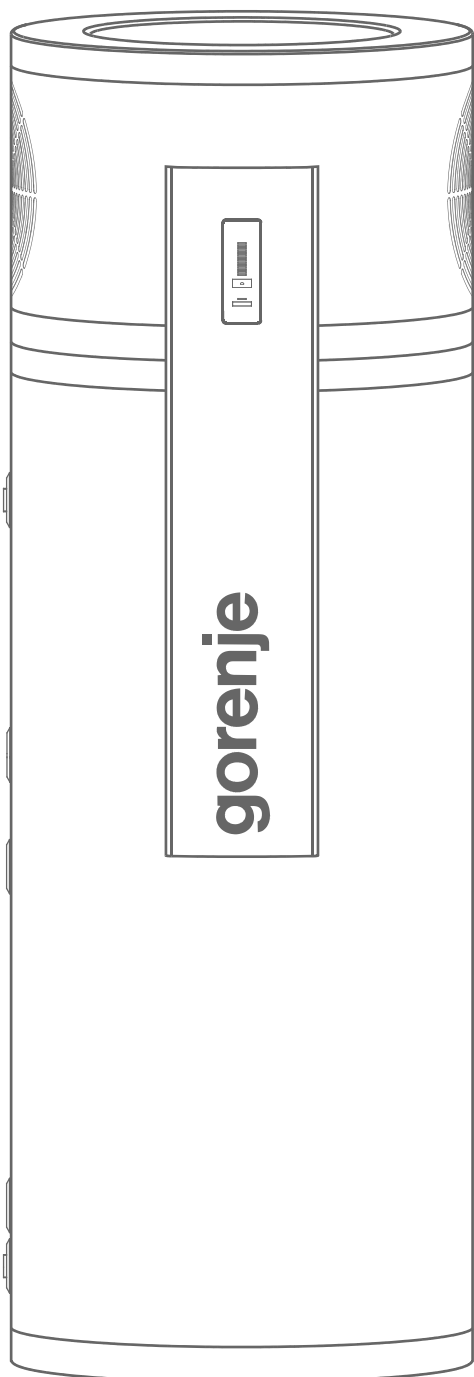

OPOZORILA

- ⚠ Napravo lahko uporabljajo otroci stari 8 let in starejši in osebe z zmanjšanimi fizičnimi, čutnimi ali mentalnimi sposobnostmi ali s pomanjkanjem izkušenj oz. znanjem če so pod nadzorom ali poučeni glede uporabe naprave na varen način in da razumejo možne nevarnosti.
- ⚠ Otroci se ne smejo igrati z napravo.
- ⚠ Čiščenja in vzdrževanja naprave ne smejo izvajati otroci brez nadzora.
- ⚠ Napravo prevažajte v navpičnem položaju, izjemoma jo lahko nagnete do 35° v vse smeri. Pazite, da med transportom ne poškodujete ohišja in vitalnih delov naprave.
- ⚠ Naprava ni namenjena uporabi v prostorih, kjer so prisotne korozivne in eksplozivne snovi.
- ⚠ Priključitev naprave na električno omrežje mora potekati v skladu s standardi za električne napeljave.
- ⚠ Med napravo in trajno inštalacijo mora biti vgrajena priprava za ločitev vseh polov od električnega omrežja v skladu z nacionalnimi inštalacijskimi predpisi.
- ⚠ Naprava zaradi nevarnosti poškodbe agregata toplotne črpalke ne sme delovati brez vode v hranilniku!
- ⚠ Instalacija mora biti izvedena v skladu z veljavnimi predpisi in po navodilih proizvajalca. Izvesti jo mora strokovno usposobljen monter.
- ⚠ Pri zaprtem, tlačnem sistemu priklučitve morate na dotočno cev hranilnika tople vode obvezno vgraditi varnostni ventil z nazivnim tlakom 0,6 MPa (6 bar), ki preprečuje zvišanje tlaka v hranilniku za več kot 0,1 MPa (1 bar) nad nazivnim.
- ⚠ Voda lahko kaplja iz odtočne odprtine varnostnega ventila, zato mora biti odtočna odprtina odprta na atmosferski tlak.
- ⚠ Izpust varnostnega ventila mora biti nameščen v smeri navzdol in v območju, kjer ne zamrzuje.
- ⚠ Za pravilno delovanje varnostnega ventila morate sami izvajati redne kontrole, po potrebi odstraniti vodni kamen in preveriti, da varnostni ventil ni blokiran.
- ⚠ Med hranilnik in varnostni ventil ne smete vgraditi zapornega ventila, ker bi s tem onemogočili delovanje varnostnega ventila!
- ⚠ Elementi v elektronski krmilni enoti so pod napetostjo tudi po pritisku tipke za izklop naprave.
- ⚠ Naprava je zaščiten za primer odpovedi delovnega termostata z dodatno toplotno varovalko, vendar v takšnem primeru v skladu z varnostnimi standardi voda v hranilniku lahko doseže temperaturo tudi do 130 °C. Pri izvedbi vodovodnih inštalacij je obvezno potrebno upoštevati možnost, da lahko pride do navedenih temperaturnih preobremenitev.
- ⚠ Če boste napravo izključili iz električnega omrežja, morate ob nevarnosti zamrznitve iztočiti vodo iz hranilnika.
- ⚠ Voda iz hranilnika se izprazni skozi dotočno cev. V ta namen je priporočljivo med varnostni ventil in dotočno cev namestiti poseben člen ali izpustni ventil.
- ⚠ Prosimo Vas, da morebitnih okvar na napravi ne popravljate sami, ampak o njih obvestite najbližjo pooblaščen servisno službo.
- ⚠ Pri padcu temperature dodatnega vira ogrevanja in pri omogočeni cirkulaciji vode skozi prenosnik toplote, lahko pride do nenadzorovanega odvzema toplote iz hranilnika vode. Ob priklučitvi na druge vire ogrevanja je potrebno poskrbeti za pravilno izvedbo temperaturne regulacije dodatnega vira.
- ⚠ V primeru priklučitve sprejemnikov sončne energije kot zunanji vir toplote mora biti delovanje agregata toplotne črpalke izključeno. Sicer lahko kombinacija obeh virov privede do pregretja sanitarne vode in s tem posledično do previsokih tlakov.
- ⚠ Cirkulacijski vod privede do dodatnih toplotnih izgub v hranilniku vode.
- ⚠ V izvedbi brez grela hranilnik tople vode nima zaščite pred zmrzovanjem!
- ⚠ Naprava vsebuje fluorirane toplogredne pline. Hermetično zaprto.

Cenjeni kupec, zahvaljujemo se Vam za nakup našega izdelka. PROSIMO, DA PRED VGRADNJO IN PRVO UPORABO GRELNIKA VODE S TOPLOTNO ČRPALKO SKRBNO PREBERETE NAVODILA.

Grelnik vode s toplotno črpalko je izdelan v skladu z veljavnimi standardi, ki proizvajalcu dovoljujejo uporabo CE znaka. Njegove osnovne tehnične lastnosti so navedene na napisni tablici, nalepljeni na zadnji zgornji strani hranilnika.

Grelnik vode s toplotno črpalko sme priključiti le za to usposobljen strokovnjak. **Posege v njegovo notranjost zaradi popravila, odstranitve vodnega kamna ter preverjanja ali zamenjave protikorozijske zaščitne anode lahko opravi samo pooblaščen servisna služba.** Posebej skrbno upoštevajte napotke za ravnanje ob morebitnih napakah in varno uporabo naprave.

To knjižico shranite, da jo boste lahko pogledali, kadar boste v dvomih glede delovanja ali vzdrževanja.

Navodila za namestitev in uporabo so prav tako na voljo na naših spletnih straneh <http://www.gorenje.com> ali na nacionalnih straneh v rubriki servis oziroma podpora.

Vedno lahko pokličete pooblaščen servisere za občasno vzdrževanje. Na razpolago so Vam s svojimi izkušnjami.

Grelnik vode s toplotno črpalko in vgrajenim cevni prenosnikom toplote je izdelan tako, da lahko uporabite tudi druge vire ogrevanja kot so npr. kotel centralnega ogrevanja, sončni kolektorji, ...

PODROČJE UPORABE

Tovrstne izvedbe grelnikov s toplotno črpalko so namenjene predvsem segrevanju potrošne vode v gospodinjstvih in pri drugih porabnikih, kjer dnevna potrošnja tople vode (50 °C) ne presega 400 do 700 l. **Nastavitev temperature na napravi naj bo takšna, da zadostuje dejanskim potrebam, priporočljive nastavitve so med 45 in 55°C. Višje nastavitve niso priporočene, saj se pri teh zmanjša učinkovitost (COP) in podaljšajo časi segrevanj oz. poveča se št. obratovalnih ur.** Ker grelnik vode s toplotno črpalko pri svojem delovanju hladi prostor je koristnost uporabe naprave dvojna (gretje vode - hlajenje prostora). Delovanje grelnika vode s toplotno črpalko je popolnoma avtomatsko.

Naprava mora biti priključen na hišno napeljavo sanitarne tople vode, za svoje delovanje potrebuje električno napajanje. Zaradi lažje kontrole in servisiranja nad napravo pustite zadosti prostora (sliki 2 in 3). Drugačna uporaba od navedene v navodilih za to napravo ni dovoljena. Naprava ni namenjen uporabi v prostorih, kjer so prisotne korozivne in eksplozivne snovi. Proizvajalec ne odgovarja za poškodbe nastale zaradi neprimerne vgradnje in neustrezne uporabe, ki ni v skladu z navodili za montažo in uporabo.

Navodila za uporabo so sestavni in pomemben del izdelka in morajo biti izročena kupcu. Pazljivo preberite opozorila v navodilih, ker so v njih navedeni pomembni napotki glede varnosti pri instalaciji, uporabi in vzdrževanju. Navodila shranite za morebitno kasnejšo uporabo.

Oznaka vaše naprave je navedena na napisni ploščici, ki je nameščena na zadnji zgornji strani hranilnika.

Ko odstranite embalažo, preglejte vsebino. V primeru dvoma se obrnite na dobavitelja. Elementov embalaže (sponke, plastične vrečke, ekspanziran polistiren itd.) ne puščajte na doseg otrok, ker so to potencialni viri nevarnosti, niti jih ne odložite kamorkoli v okolje.

⚠ Naprava ni namenjena uporabi v prostorih, kjer so prisotne korozivne in eksplozivne snovi.

SKLADIŠČENJE IN TRANSPORT

Skladiščenje naprave mora biti zagotovljeno v navpičnem položaju v suhem in čistem prostoru.

⚠ Napravo prevažajte v navpičnem položaju, izjemoma jo lahko nagnete do 35° v vse smeri. Pazite, da med transportom ne poškodujete ohišja in vitalnih delov naprave.

TEHNIČNE LASTNOSTI NAPRAVE

KLJUČ TIPA

TCMXXYZV

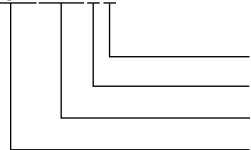

Oznaka G – vgrajeno grelo; brez oznake – nima vgrajenega grela
 Pozicija agregata (oznaka Z – zgoraj)
 Prostornina, prenosnik toplote (0 – brez prenosnika, 1 – en prenosnik, 6 – en spodnji prenosnik)
 Grelnik vode s toplotno črpalko s kovinsko oblogo

Tip		TCM200ZG	TCM201ZG	TCM300ZG	TCM306ZG
Profil rabe		L	L	XL	XL
Razred energijske učinkovitosti ¹⁾		A+	A+	A+	A+
Energijska učinkovitost ogrevanja vode η_{wh} ¹⁾	%	177,6	176,1	179,2	178,9
Letna poraba električne energije ¹⁾	kWh	576	581	935	936
Dnevna poraba električne energije ¹⁾	kWh	2,709	2,739	4,352	4,362
Nastavljena temperatura termostata	°C	55	55	55	55
Nivo zvokovne moči v notranjih prostorih ²⁾	dB (A)	58,3	58,3	59	59
Vrednost smart		0	0	0	0
Prostornina	l	200	190	285	275
Mešana voda pri 40°C V40 ⁴⁾	l	265	255	395	380
Morebitni varnostni ukrepi (sestava, nameščanje, vzdrževanje)		Pri tlačni priključitvi obvezna uporaba varnostnega ventila			
Tehnične lastnosti					
Čas segrevanja A15 / W10-55 ³⁾	h:min	08:07	7:36	08:15	07:55
Čas segrevanja A20 / W10-55 ⁴⁾	h:min	07:19	06:59	07:14	06:57
Poraba energije pri izbranem profilu rabe A15 / W10-55 ³⁾	kWh	3,01	3,03	4,74	4,77
Poraba energije pri izbranem profilu rabe A20 / W10-55 ⁴⁾	kWh	2,72	2,75	4,36	4,37
COP _{DHW} A15/W10-55 ³⁾		3,9	3,9	4,0	4,0
COP _{DHW} A20/W10-55 ⁴⁾		4,3	4,3	4,4	4,4
Moč v stanju pripravljenosti ⁴⁾	W	15	17	17	18
Hladilno sredstvo		R134a	R134a	R134a	R134a
Količina hladiva	kg	0,950	0,950	1,100	1,100
Potencial globalnega segrevanja		1430	1430	1430	1430
Ekvivalent ogljikovega dioksida	t	1,359	1,359	1,573	1,573
Območje delovanja	°C	7 / 40	7 / 40	7 / 40	7 / 40
Električne karakteristike					
Nazivna električna moč kompresorja	W	350	350	490	490
Moč grela ⁵⁾	W	2000	2000	2000	2000
Maksimalna priključna moč brez grela/z grelom	W	350/2350	350/2350	490/2490	490/2490
Napetost	V/Hz	230/50	230/50	230/50	230/50
Električno varovanje	A	16	16	16	16
Stopnja zaščite pred vlago		IP21	IP21	IP21	IP21
Hranilnik vode					
Protikorozijska zaščita kotla		Emajlirano / Mg anoda			
Nazivni tlak	MPa	0,6/0,9/1,0	0,6/0,9/1,0	0,6/0,9/1,0	0,6/0,9/1,0
Najvišja temperatura vode - toplotna črpalka	°C	65	65	65	65
Najvišja temperatura vode - električno grelo ⁵⁾	°C	75	75	75	75
Priključne mere					
Višina skupna	mm	1860	1860	1960	1960
Širina	mm	570	570	670	670
Globina	mm	585	585	685	685
Priključki na vodovodno omrežje		G3/4	G3/4	G1	G1
Ogrevana površina prenosnika toplote	m ²	/	1,1	/	1,1
Priključki prenosnika toplote		-	G1	-	G1
Neto/bruto/masa z vodo	kg	93/105/293	111/123/301	139/151/424	157/169/432
Temperatura grelnega medija v prenosniku toplote	°C	/	5 / 95	/	5 / 95
Transportni podatki					
Mere embalaže	mm	760x760x2060	760x760x2060	800x800x2160	800x800x2160

¹⁾ direktiva 812/2013, 814/2013, EN16147:2017, notranji zrak 20 °C

²⁾ po EN12102:2013

³⁾ vstopna temperatura zraka 15 °C, 74% vlažnost, voda ogrevana od 10 do 55 °C po EN16147:2017

⁴⁾ vstopna temperatura zraka 20 °C, 58% vlažnost, voda ogrevana od 10 do 55 °C po EN16147:2017

⁵⁾ izvedba z grelom

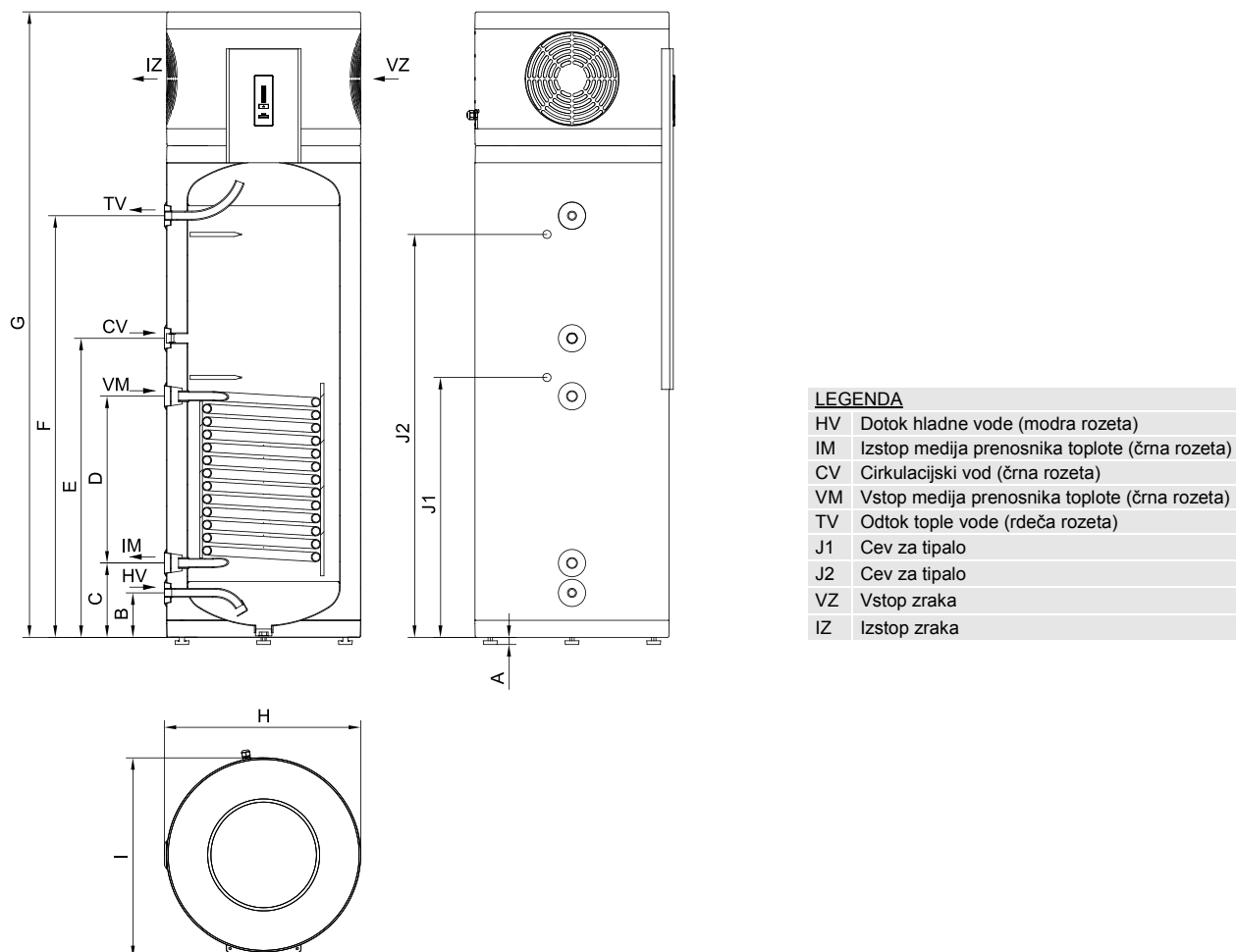

Sl. 1: Priključne in montažne mere grelnika vode s toplotno črpalko [mm]

	TCM200ZG	TCM201ZG	TCM300ZG	TCM306ZG
A (mm)	25	25	25	25
B (mm)	130	130	140	140
C (mm)	/	218	/	245
D (mm)	/	490	/	490
E (mm)	880	880	880	880
F (mm)	1240	1240	1250	1250
G (mm)	1835	1835	1930	1930
H (mm)	570	570	670	670
I (mm)	585	585	685	685
J1 (mm)	/	765	/	805
J2 (mm)	/	1185	/	1185
HV	G3/4	G3/4	G1	G1
IM	/	G1	/	G1
CV	G3/4	G3/4	G3/4	G3/4
VM	/	G1	/	G1
TV	G3/4	G3/4	G1	G1

NAMESTITEV TIPAL ZUNANJAGA VIRA OGREVANJA

Na levi strani hranilnika tople vode sta odprtini (J1, J2), kjer se lahko vstavijo tipala za regulacijo sistemske povezave hranilnika tople vode z drugimi viri ogrevanja. Maksimalni premer tipala je 8 mm. Dolžina cevi za senzor znaša 180 mm.

Tipalo vstavite v cev in ga fiksirate:

- če boste tipalo namestili v višjo pozicijo, se bo termostat hitreje odzival, obdobja obratovanja obtočne črpalke bodo krajša, razlika med temperaturo vode v hranilniku in ogrevalnim medijem po izklopu termostata bo večja, posledično bo količina tople vode v hranilniku manjša.
- če boste tipalo namestili v nižjo pozicijo, bodo obdobja obratovanja obtočne črpalke daljša, razlika med temperaturo ogrevalnega medija in doseženo temperaturo vode v hranilniku bo manjša in s tem bo količina tople vode v hranilniku zato večja.

NAMESTITEV NAPRAVE

Grelnik vode s toplotno črpalko je namenjen obratovanju s prostorskim zrakom. Pri obratovanju se za ogrevanje sanitarne vode uporabi samo energija zraka iz postavitvenega prostora. Naprava se lahko namesti v prostor, kjer ne zmrzuje, po možnosti v bližino drugih virov ogrevanja, s temperaturo od 7 do 40 °C in minimalno prostornino 20 m³. V splošnem pa priporočamo dovolj velik in zračen prostor s temperaturo nad 15 °C, kar predstavlja optimalne pogoje za delovanje toplotne črpalke. Željena stopnja izmenjave zraka za stanovanjsko zgradbo znaša 0,5. To pomeni, da se celotna količina zraka v zgradbi izmenja vsaki 2 uri.

Pri izbiri prostora za namestitev naprave je poleg prej omenjenih napotkov potrebno še posebej paziti, da izbran prostor ni prašen, kajti prah škodljivo vpliva na učinek toplotne črpalke.

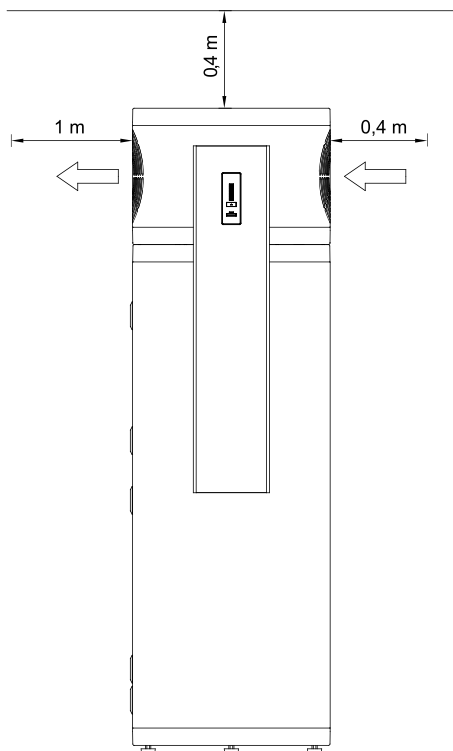

Sl. 2: Minimalne zahteve za namestitev naprave

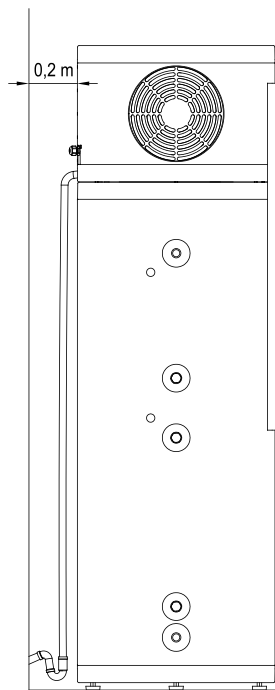

Sl. 3: Odvod kondenzata

Pri delovanju toplotne črpalke se v notranjosti agregata tvori kondenzat. Tega je potrebno odvajati v kanalizacijo preko gibljive odtočne cevi Ø16mm za kondenzat na zadnji strani toplotne črpalke. Količina kondenzata je odvisna od temperature in vlažnosti zraka. Zaradi lažjega in hitrejšega odvajanja kondenzata, priporočamo do 2° naklon grelnika vode s toplotno črpalko v smeri proti odtočni cevi (sl. 3).

Za zmanjšanje prenosa hrupa in tresljajev vgrajenega ventilatorja upoštevajte naslednje ukrepe, da se zvok delovanja in vibracije ne prenašajo preko sten v prostore, kjer bi bilo to moteče (spalnice, prostori za počitek):

- vgradite fleksibilne povezave za hidravlične priključke
- predvidite izolacijo tresljajev proti tlom
- uporabite postavitvene noge.

PRIKLJUČITEV NA VODOVODNO OMREŽJE

Priključitev na vodovodno omrežje napravite po označbah za priključke iz predhodnega poglavja (sl. 1).

Na dotočno cev je zaradi varnosti delovanja obvezno treba vgraditi varnostni ventil, ki preprečuje zvišanje tlaka v kotlu za več kot 0,1 MPa (1 bar) nad nominalnim. Iztočna šoba na varnostnem ventilu mora imeti obvezno izhod na atmosferski tlak. Za pravilno delovanje varnostnega ventila morate sami periodično izvajati kontrole, po potrebi odstraniti vodni kamen in preveriti, da varnostni ventil ni blokirano. Ob preverjanju morate s premikom ročke ali odvitjem matice ventila (odvisno od tipa ventila) odpreti iztok iz varnostnega ventila. Pri tem mora priteči skozi iztočno šobo ventila voda, kar je znak, da je ventil brezhiben. Pri segrevanju vode se tlak vode v hranilniku zvišuje do meje, ki je nastavljena v varnostnem ventilu. Ker je vračanje vode nazaj v vodovodno omrežje preprečeno, lahko pride do kapljanja vode iz odtočne odprtine varnostnega ventila. Kapljajočo vodo lahko speljete v odtok preko lovilnega nastavka, ki ga namestite pod varnostni ventil. Odtočna cev nameščena pod izpustom varnostnega ventila mora biti nameščena v smeri naravnost navzdol in v okolju, kjer ne zmrzuje.

V primeru, da zaradi neustrezno izvedene inštalacije nimate možnosti, da bi kapljajočo vodo iz varnostnega ventila speljali v odtok, se lahko kapljanju izognete z vgradnjo ekspanzijske posode na dotočni cevi hranilnika. Volumen ekspanzijske posode je minimalno 5% volumna hranilnika.

Hranilnik tople vode lahko priključite na hišno vodovodno omrežje brez redukcijskega ventila, če je tlak v omrežju nižji od predpisanega na napisni tablici. V nasprotnem primeru je potrebno vgraditi redukcijski ventil tlaka, ki zagotavlja, da tlak na dotoku v hranilnik tople vode ne presega nazivnega.

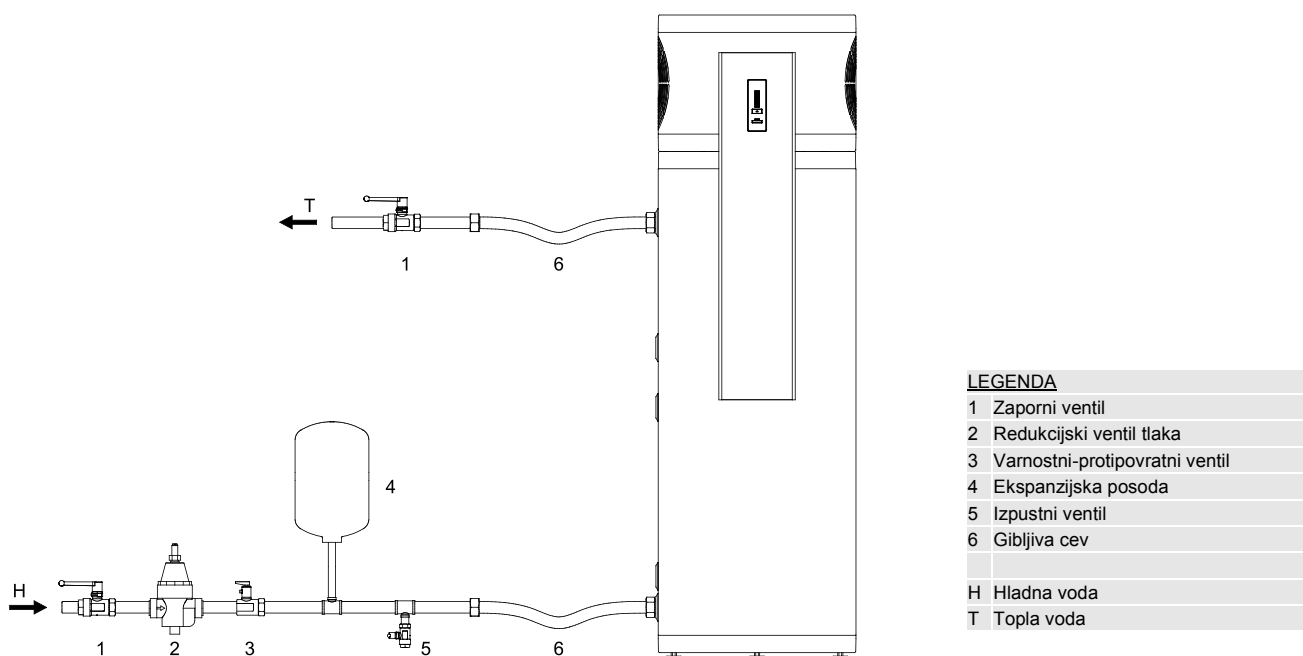

Sl. 4: Zaprti (tlačni) sistem

⚠ Grelnik vode s toplotno črpalko zaradi nevarnosti poškodbe agregata ne sme delovati brez vode v hranilniku!

PRIKLJUČITEV NA DRUGE VIRE OGREVANJA

Grelnik vode s toplotno črpalko in cevnim prenosnikom v hranilniku omogoča pripravo sanitarne vode v kombinaciji z različnimi viri energije (npr. centralno ogrevanje, sončna energija, ...).

Možnosti povezave hranilnika tople vode z različnimi viri ogrevanja so prikazane na skicah.

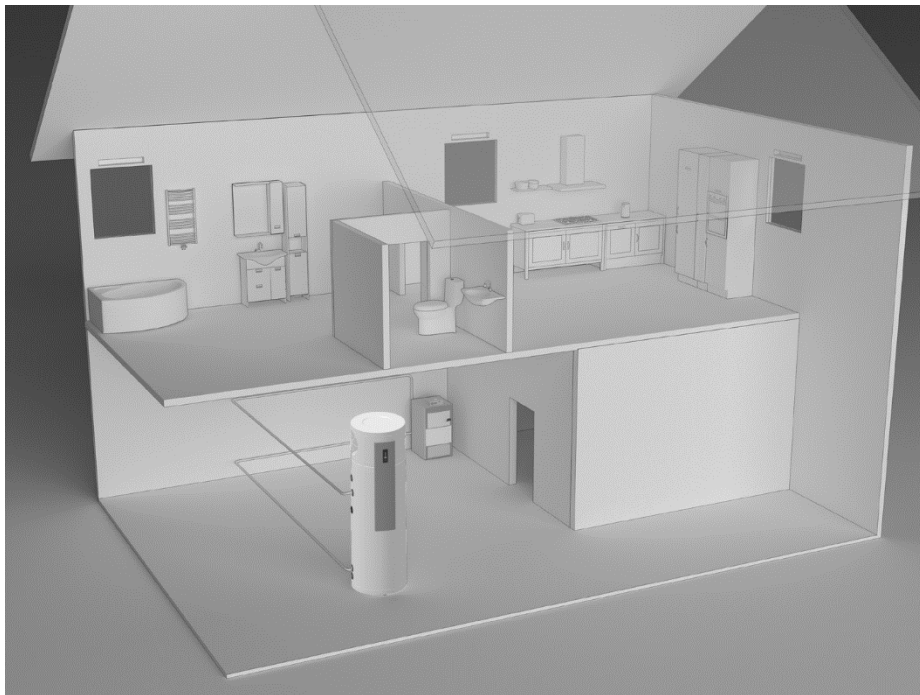

Sl. 5a: Priključitev na centralno ogrevanje

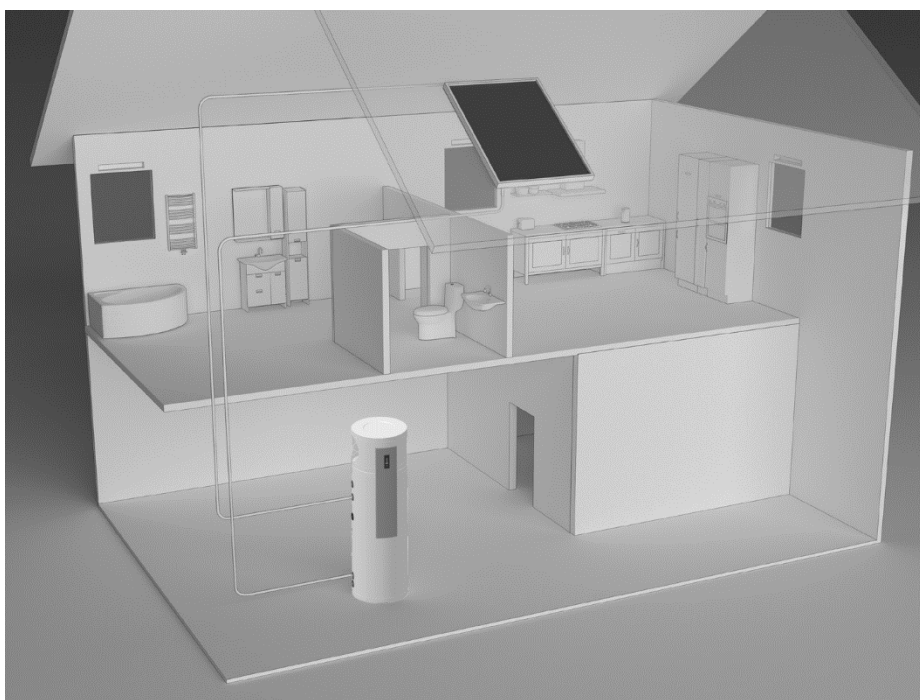

Sl. 5b: Priključitev na sončni kolektor

- ⚠** Pri padcu temperature dodatnega vira ogrevanja in pri omogočeni cirkulaciji vode skozi prenosnik toplote, lahko pride do nenadzorovanega odvzema toplote iz hranilnika vode. Ob priključitvi na druge vire ogrevanja je potrebno poskrbeti za pravilno izvedbo temperaturne regulacije dodatnega vira.
- ⚠** V primeru priključitve sprejemnikov sončne energije kot zunanji vir toplote mora biti delovanje agregata izključeno. Sicer lahko kombinacija obeh virov privede do pregretja sanitarne vode in s tem posledično do previsokih tlakov.
- ⚠** Cirkulacijski vod privede do dodatnih toplotnih izgub v hranilniku vode.

PRIKLJUČITEV NA ELEKTRIČNO OMREŽJE

Za priključitev naprave je potrebno zagotoviti vtičnico, ki je primerna za tokovno obremenitev navedeno v tabeli s tehničnimi podatki. Priključitev naprave na električno omrežje mora potekati v skladu s standardi za električne napeljave. Med napravo in trajno inštalacijo mora biti vgrajena priprava za ločitev vseh polov od električnega omrežja v skladu z nacionalnimi inštalacijskimi predpisi.

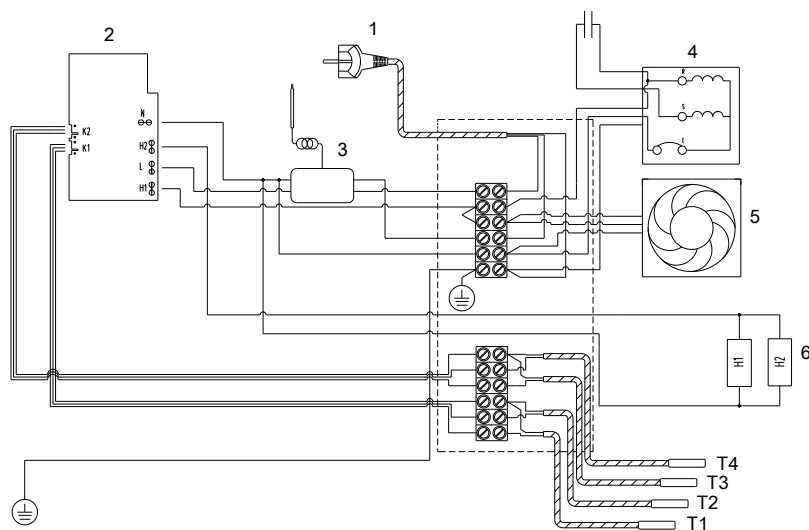

LEGENDA	
1	Napajalni kabel
2	Elektronski modul
3	Termična varovalka
4	Kompresor
5	Ventilator
6	Električno grelo
T1	Temperaturno tipalo (električno grelo)
T2	Temperaturno tipalo (toplotna črpalka)
T3	Temperaturno tipalo (zrak)
T4	Temperaturno tipalo (uparjalnik)

Sl. 6: Shema električne vezave

UPRAVLJANJE NAPRAVE

Po priključitvi naprave na vodovodno in električno omrežje, ter z vodo napolnjenim hranilnikom, je le-ta pripravljena na delovanje. Ob priklopu na napajalno napetost toplotna črpalka preide v stanje pripravljenosti. V stanju pripravljenosti toplotna črpalka vzdržuje temperaturo vode na 10 °C.

Toplotna črpalka segreva vodo v območju 10 °C - 65 °C. Od 65 °C - 75 °C vodo segreva električno grelo.

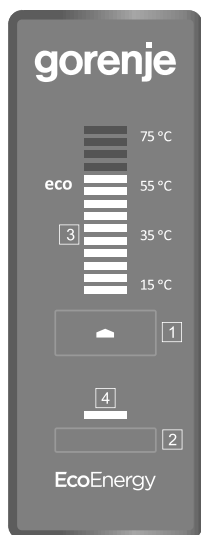

LEGENDA	
1	Tipka vklop/izklop toplotne črpalke, nastavitve temperature vode
2	Tipka za vklop/izklop električnega grela
3	Prikazovalnik nastavljene/dejanske temperature vode v hranilniku, signalizacija napak
4	Indikacija delovanja električnega grela in funkcije "TURBO"

Sl. 7: Upravljalna plošča

Vklop / izklop toplotne črpalke

Toplotno črpalko vklopite z daljšim pritiskom (3 s) na tipko 1.

S ponovnim daljšim pritiskom (3 s) na tipko 1 toplotna črpalka vedno preide v stanje pripravljenosti.

Nastavitev temperature

Temperaturo nastavljate s pritiskanjem tipke [1] na zelen temperaturni nivo (tovarniško nastavljena temperatura je 55 °C). Območje nastavitve temperature je od 10 °C do 75 °C s korakom 5 °C. Ko dosežete maksimalni nivo 75 °C, se ob naslednjem pritisku tipke [1] vrnete na minimalni nivo 10 °C. Priporočamo nastavitve na "eco". Pri tej nastavitvi bo temperatura vode približno 55 °C, izločanje vodnega kamna in toplotne izgube pa bodo manjše kot pri nastavitvah na višjo temperaturo. Po zadnjem pritisku tipke [1] je nastavitev shranjena, čez nekaj časa (cca. 5 s) se na prikazovalniku [3] prikaže trenutni temperaturni nivo v kotlu. Če boste napravo izključili iz električnega omrežja, morate ob nevarnosti zamrznitve iztočiti vodo iz hranilnika.

V spodnji tabeli je prikazana osvetlitev LED diod za posamezni temperaturni nivo.

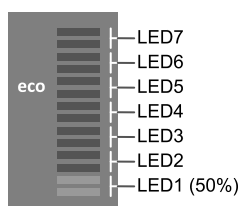

Sl. 8a: Primer nastavitve temperature na 10 °C

Oznaka	LED segment	Osvetlitev za posamezni temperaturni nivo	
		50%	100%
/	LED7 (LED1-LED6 100%)	70 °C	75 °C
/	LED6 (LED1-LED5 100%)	60 °C	65 °C
eco	LED5 (LED1-LED4 100%)	50 °C	55 °C
/	LED4 (LED1-LED3 100%)	40 °C	45 °C
/	LED3 (LED1-LED2 100%)	30 °C	35 °C
/	LED2 (LED1 100%)	20 °C	25 °C
/	LED1	10 °C	15 °C

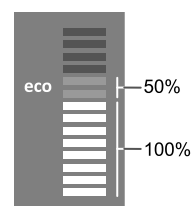

Sl. 8b: Primer nastavitve temperature na 50 °C

Zaščita pri izpadu električne energije

V primeru izpada električne energije ostanejo podatki o nastavitvah trajno shranjeni. Po ponovnem zagonu deluje naprava v enakem režimu, kot je bila pred prekinitvijo napajanja.

Vklop načina delovanja "TURBO"

Ta način delovanja je primeren predvsem takrat, ko hitro potrebujete večjo količino tople vode. V načinu delovanja "TURBO" se voda v hranilniku segreva s toplotno črpalko in električnim grelom sočasno. Pomeni hitrejše segrevanje vode na temperaturni nivo, ki ste ga nastavili.

Izbirate lahko med enkratnim in konstantnim vklopom funkcije "TURBO".

Za enkratni vklop na kratko pritisnete tipko [2]. Delovanje v načinu "TURBO" pokaže indikator [4], ki sveti dokler se voda v hranilniku ne segreje do nastavljene temperature. Po doseženi temperaturi se funkcija samodejno izklopi, indikator [4] ugasne.

Za konstantni vklop za dalj časa (3 s) pritisnete tipko [2]. Delovanje v konstantnem načinu "TURBO" pokaže indikator [4], ki sveti. Po doseženi temperaturi se funkcija ne izklopi samodejno. Funkcijo izklopite s kratkim pritiskom na tipko [2], indikator [4] ugasne.

Med delovanjem funkcije "TURBO" je možna nastavitev temperature, izklop funkcije in izklop naprave.

Protilegionelni program

Če voda v hranilniku v roku 14 dni ne doseže 65 °C, se vključi protilegionelni program ter vodo v hranilniku segreje na 70 °C. V času izvajanja protilegionelnega programa se na prikazovalniku [3] zaporedoma prižigajo posamezni segmenti, kot kaže sl. 9. Med delovanjem protilegionelnega programa ni možna nastavitev temperature, možen pa je vklop in izklop funkcije "TURBO".

Če med delovanjem protilegionelnega programa izklopite napravo ali pride do izpada električne energije, se po ponovnem vklopu naprave, delovanje protilegionelnega programa nadaljuje.

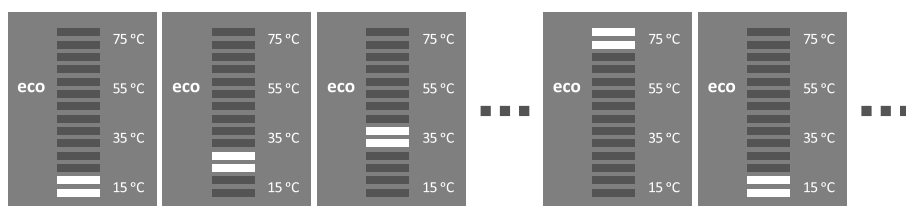

Sl. 9: Signalizacija delovanja protilegionelnega programa

⚠ Opozorilo: po segrevanju v protilegionelnem programu je temperatura vode v kotlu 65 °C ali več ne glede na nastavljeno temperaturo na napravi.

Vklop / izklop protilegionelnega programa

Z daljšim pritiskom (3 s) na tipko [1] napravo izklopite. Elektronika preide v stanje pripravljenosti. S sedemkratnim (7x) kratkim pritiskom na tipko [1] se prikaže trenutno stanje funkcije protilegionele. Stanje funkcije prikazujeta LED1 ali LED7. Če sveti LED1 pomeni, da je funkcija protilegionelni program izklopljena (sl. 10b). Če sveti LED7 pomeni, da je funkcija protilegionela vklopljena (sl. 10a). S ponovnim kratkim pritiskom na tipko [1] spremenite nastavev. Nastavev je shranjena ko 5 sekund ni pritiska na tipko [1]. Elektronika se vrne v stanje pripravljenosti. Napravo ponovno vklopite z daljšim pritiskom (3 s) na tipko [1].

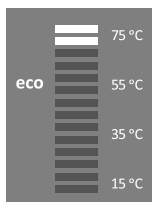

Sl. 10a: Vklopljen protilegionelni program

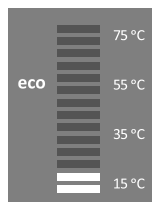

Sl. 10b: Izklopljen protilegionelni program

Rezervni režim delovanja

Če je temperatura vstopnega zraka nižja od 7 °C ali višja od 40 °C naprava preide v rezervni režim delovanja. Kompresor in ventilator ne delujeta, za segrevanje sanitarne vode se vklopi električno grelo. Grelnik vode s toplotno črpalko deluje v rezervnem režimu. Možnost preklopa na normalni režim delovanja se ciklično preverja. Ko so izpolnjeni temperaturni pogoji za normalno delovanje toplotne črpalke, naprava preide v normalen režim delovanja. Grela se izklopi. Delovanje v rezervnem režimu prikazuje indikator [4], ki utripa dokler naprava ne preide v normalen režim delovanja.

Posebnosti delovanja toplotne črpalke

Kompresor in ventilator toplotne črpalke po vklopu vedno delujeta najmanj 5 minut (minimalni čas delovanja kompresorja). Kompresor in ventilator toplotne črpalke po izklopu ne delujeta najmanj 20 minut (minimalni čas mirovanja kompresorja). V kolikor v tem času pride do zahteve za vklop kompresorja se le ta ne izvede. Na prikazovalniku [3] (sl. 11) počasi utripa LED4 (interval 5 sekund). Po pretečenem času mirovanja se kompresor in ventilator samodejno vklopita. Na prikazovalniku [3] se prikaže trenutni temperaturni nivo vode v hranilniku. Med mirovanjem kompresorja je možna nastavev temperature, vklop funkcije "TURBO" in izklop naprave.

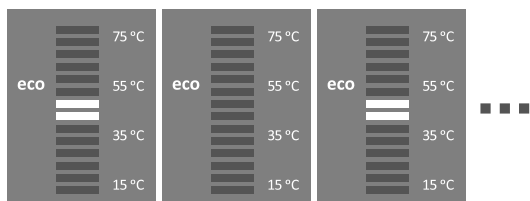

Sl. 11: Mirovanje kompresorja

Indikacija napak

V primeru napake na prikazovalniku [3] pričnejo utripati kontrolne svetilke. Med prikazovanjem napak ni možna nastavev temperature, vklop funkcije "TURBO", možen je samo izklop naprave.

Napaka	Opis napake	Signalizacija	Rešitev
E2	Napaka temperaturnega tipala (toplotna črpalka)	Ponavljajoči 2x hitri utrip indikatorja [3].	Kličite servis (toplotna črpalka vseeno deluje).
E3	Napaka temperaturnega tipala (električno grelo)	Ponavljajoči 3x hitri utrip indikatorja [3].	Kličite servis (toplotna črpalka vseeno deluje, električno grelo ne deluje).
E4	Napaka temperaturnega tipala (uparjalnik)	Ponavljajoči 4x hitri utrip indikatorja [3].	Kličite servis (toplotna črpalka vseeno deluje).
E5	Napaka temperaturnega tipala (zrak)	Ponavljajoči 5x hitri utrip indikatorja [3].	Kličite servis (toplotna črpalka vseeno deluje).
E6	Pregrevanje (temperatura > 90 °C)	Ponavljajoči 6x hitri utrip indikatorja [3].	Odklopite toplotno črpalko iz električnega omrežja, kličite servis.

Če se pojavi več napak hkrati, se le te zaporedoma prikazujejo na prikazovalniku [3] (npr. pri hkratni napaki E4 in E5 se ponavljajoče prikazuje: 4x hitri utrip kontrolnih svetilk, premor, 5x hitri utrip kontrolnih svetilk, premor).

Če se hkrati pojavita napaki E2 in E3 toplotna črpalka in električno grelo ne delujeta.

Če se hkrati pojavita napaki E4 in E5 naprava preide v rezervni režim delovanja.

UPORABA IN VZDRŽEVANJE

Po priključitvi na vodovodno omrežje ter druge vire ogrevanja je grelnik vode s toplotno črpalko pripravljen za uporabo. Kadar obstaja nevarnost, da bo voda v hranilniku tople vode zmrznila, jo morate iz njega iztočiti. Pri tem odpremo ročico za toplo vodo na eni od mešalnih baterij, ki je priključena na hranilnik tople vode. Vodo iz hranilnika tople vode izpustimo skozi za to predviden izpustni ventil na dotočni cevi.

Zunanost naprave čistite z mehko krpo in blagimi tekočimi čistili. Ne uporabljajte čistil, ki vsebujejo alkohol ali abrazivna sredstva. V primeru, da je naprava izpostavljena prahu se lahko zamašijo lamele uparjalnika, kar škodljivo vpliva na njeno delovanje.

Z rednimi servisnimi pregledi boste zagotovili brezhibno delovanje in dolgo življenjsko dobo grelnika vode s toplotno črpalko. Garancija za prerjavenje kotla velja le, če ste izvajali predpisane redne preglede izrabljenosti zaščitne anode. Obdobje med posameznimi rednimi pregledi ne sme biti daljše kot je navedeno v garancijski izjavi. Pregledi morajo biti izvedeni s strani pooblaščenega serviserja, ki Vam pregled evidentira na garancijskem listu proizvoda. Ob pregledu preveri izrabljenost protikorozijske zaščitne anode in po potrebi očisti vodni kamen, ki se glede na kakovost, količino in temperaturo porabljene vode nabere v notranjosti hranilnika. Servisna služba vam bo po pregledu hranilnika tople vode glede na ugotovljeno stanje priporočila tudi datum naslednje kontrole.

Kljub skrbni proizvodnji in kontroli lahko pride pri delovanju grelnika vode s toplotno črpalko do določenih težav in napak, katere mora praviloma odpraviti pooblaščen serviser.

Pred prijavo morebitne napake pa preverite sledeče:

- Če je z dovodom električne energije vse v redu?
- Če ima izhajajoči zrak ovire?
- Če je temperatura okolice prenizka ali previsoka?
- Če se ne sliši delovanje kompresorja in ventilatorja?

⚠ Prosimo Vas, da morebitnih okvar na napravi ne popravljate sami, ampak o njih obvestite najbližjo servisno službo.



Naši izdelki so opremljeni z okolju in zdravju neškodljivimi komponentami in so izdelani tako, da jih lahko v njihovi zadnji življenjski fazi čim bolj enostavno razstavimo in recikliramo.

Z reciklažo materialov zmanjšujemo količine odpadkov in zmanjšamo potrebo po proizvodnji osnovnih materialov (na primer kovine), ki zahteva ogromno energije ter povzroča izpuste škodljivih snovi. Z reciklažnimi postopki tako zmanjšujemo porabo naravnih virov, saj lahko odpadne dele iz plastike in kovin ponovno vrnemo v različne proizvodne procese.

Za več informacij o sistemu odlaganja odpadkov obiščite svoj center za odlaganje odpadkov, ali trgovca, pri katerem je bil izdelek kupljen.

PRIDRŽUJEMO SI PRAVICO DO SPREMEMB, KI NE VPLIVAJO NA FUNKCIONALNOST NAPRAVE.

Navodila za uporabo so na voljo tudi na naših spletnih straneh <http://www.gorenje.com>.

WARNINGS

- ⚠ The appliance may be used by children aged 8 and older and persons with physical, sensory or mental disabilities or lacking experience or knowledge, if they are under supervision or taught about safe use of the appliance and if they are aware of the potential dangers.
- ⚠ Children should not play with the appliance.
- ⚠ Children should not clean or maintain the appliance without supervision.
- ⚠ During transport, the appliance must be placed in the upright position. In exceptional cases, it may be inclined by up to 35° in all directions. Make sure the housing or vital parts of the product are not damaged during transport.
- ⚠ The appliance must not be placed in a closed space containing corrosive and explosive materials.
- ⚠ The connection of the appliance to the power supply must be performed in accordance with the standards for electrical installations.
- ⚠ A device for the disconnection from the electrical network must be installed between the appliance and the electrical network in accordance with the national installation regulations.
- ⚠ In order to avoid damage to the heat pump power unit, never operate the appliance without any water in the tank!
- ⚠ The installation should be performed in accordance with the valid regulations and the instructions of the manufacturer. It should be performed by a professionally trained installation expert.
- ⚠ In case of a closed pressurized system, it is obligatory to install a safety valve with a rated pressure of 0.6 MPa (6 bar) on the inlet pipe of the hot water storage tank to prevent the elevation of pressure in the tank by more than 0.1 MPa (1 bar) above the rated pressure.
- ⚠ Water may drip from the outlet opening of the safety valve. Therefore, so the outlet opening should be set to atmospheric pressure.
- ⚠ The outlet of the safety valve should be installed facing downwards and in a non-freezing area.
- ⚠ To ensure proper functioning of the safety valve, the user should perform regular controls to remove limescale and make sure the safety valve is not blocked.
- ⚠ Do not install a shut-off valve between the water tank and the safety valve, as this would disable the operation of the safety valve!
- ⚠ Elements in the electronic control unit are energised even after you press the appliance off key.
- ⚠ The storage tank is protected in case of failure of the operating thermostat with an additional thermal cut-out. In case of thermostat failure, water in the storage tank may reach the temperature of up to 130 °C in accordance with safety standards. The possibility of such temperature overload should be taken into consideration in the execution of plumbing.
- ⚠ Should you choose to disconnect the power, the storage tank should be drained thoroughly before the onset of freezing conditions.
- ⚠ Water from the storage tank is drained through the inlet pipe of the tank. For this purpose, a special fitting (T-fitting) with an outlet valve must be mounted between the safety valve and the inlet pipe.
- ⚠ Please, do not try to fix any defects of the appliance on your own. Call the nearest authorised service provider.
- ⚠ The decline in temperature of an additional heating source and the enabled water circulation via the heat exchanger can cause an uncontrolled removal of heat from the water tank. When connecting to other heating sources it is necessary to ensure proper temperature regulation of the additional heating source.
- ⚠ When connecting to sources of solar energy as an external heating source the aggregate of the heat pump must be disconnected. The combination of both heating systems can lead to overheating of water and consequently to excessive pressure.
- ⚠ Circulation leads to additional heat loss in the water tank.
- ⚠ In models without a heater, the hot water storage tank is not protected from freezing!
- ⚠ This appliance contains fluorinated greenhouse gases. Hermetically sealed.

Dear buyer, thank you for purchasing our product. PRIOR TO THE INSTALLATION AND FIRST USE OF HEAT PUMP WATER HEATER, PLEASE READ THESE INSTRUCTIONS CAREFULLY.

This heat pump water heater has been manufactured in compliance with the relevant Standards, which allow the manufacturer the use of the CE sign. The technical characteristics of the product are listed on the label attached to the protective cover.

The connection of the heat pump water heater to the plumbing and power networks must be carried out by qualified staff only. **All repairs and maintenance work in the interior of the storage tank, as well as limestone removal or testing or replacement of the corrosion protection anode, may only be carried out by an approved maintenance service provider.** Be especially careful when following instructions for potential errors and safe use of the appliance.

Store this booklet for times of doubt upon the functioning or maintenance.

The installation manual is available on our webpage <http://www.gorenje.com> or the webpages per country in the service and support section.

Authorised maintenance personnel are available for occasional maintenance. They will help you with their vast experience.

The design of the heat pump water heater and built-in shell and tube heat exchanger also allows using other heating sources, such as the central heating tank, solar panels etc.

USE

This heat pump water heater is designed for production of sanitary water in households and at premises where daily consumption of hot water (50 °C) does not exceed 400 l to 700 l. **The set temperature should suffice actual needs. Recommended temperature settings are between 45 and 55 °C. Higher temperatures are not recommended as they reduce the efficiency (COP) and extend the time of heating or increase the number of operating hours.** Because the heat pump water heater cools its surroundings during operation, the usefulness of the appliance is doubled (heating water – cooling air). The operation of the heat pump water heater is fully automatic.

The appliance must be connected to water supply mains and to the power supply grid. Leave enough room above the appliance for easier control and appliance servicing (figures 2 and 3). The appliance may not be used for purposes other than those defined in these Instructions. The appliance is not designed for use in rooms where corrosive or explosive substances are present. The manufacturer shall not assume any liability for damages caused by incorrect installation or misuse that are not in compliance with the Instructions for installation and use.

The instructions for use are a component and important part of this product and must be delivered to the customer. Read the warnings carefully, as they contain important directions related to safety during operation, use and maintenance. Keep these Instructions for later use.

The marking of the appliance is stated on the nameplate located on the bottom side of the unit, between both inlet pipes for sanitary water.

Once the packaging is removed, check the contents. When in doubt, contact your dealer. Never let children play with the packaging parts (clamping, plastic bags, expanded polystyrene, etc.) – potential risk. Make sure to remove and dispose of the packaging safely and in an environmentally friendly way.

⚠ The appliance is not intended for use in closed space, containing corrosive and explosive materials.

STORAGE AND TRANSPORT

Store the appliance in an upright position, in a clean and dry place.

⚠ During transport, the appliance must be placed in the upright position and may only be inclined by up to 35° in all directions in exceptional cases. Please make sure no damage of the casing and other vital parts of the appliance occurs during transport.

TECHNICAL CHARACTERISTICS

KEY TYPE

TCMXYZV

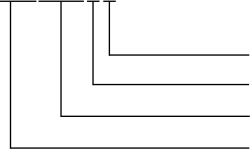

- Indication G – integrated heater; without indication – no heater installed
- Position of the heat pump power unit (indication Z – top)
- Volume, heat exchanger (0 – no heat exchanger, 1 – one heat exchanger, 6 – one bottom heat exchanger)
- Heat pump water heater with metal lining

Type		TCM200ZG	TCM201ZG	TCM300ZG	TCM306ZG
Use profile		L	L	XL	XL
Energy efficiency class ¹⁾		A+	A+	A+	A+
Energy efficiency of water heating η_{wh} ¹⁾	%	177,6	176,1	179,2	178,9
Annual electrical energy consumption ¹⁾	kWh	576	581	935	936
Daily electrical energy consumption ¹⁾	kWh	2,709	2,739	4,352	4,362
Set thermostat temperature	°C	55	55	55	55
Level of indoor sound power ²⁾	dB (A)	58,3	58,3	59	59
Smart value		0	0	0	0
Storage volume	l	200	190	285	275
Mixed water at 40°C V40 ⁴⁾	l	265	255	395	380
Potential safety measures (assembly, installation, maintenance)	Compulsory use of a safety valve with the pressure connection.				
Technical characteristics					
Heating time A15 / W10-55 ³⁾	h:min	08:07	7:36	08:15	07:55
Heating time A20 / W10-55 ⁴⁾	h:min	07:19	06:59	07:14	06:57
Energy consumption with selected use profile A15 / W10-55 ³⁾	kWh	3,01	3,03	4,74	4,77
Energy consumption with selected use profile A20 / W10-55 ⁴⁾	kWh	2,72	2,75	4,36	4,37
COP _{DHW} A15/W10-55 ³⁾		3,9	3,9	4,0	4,0
COP _{DHW} A20/W10-55 ⁴⁾		4,3	4,3	4,4	4,4
Power in standby mode ⁴⁾	W	15	17	17	18
Refrigerating agent		R134a	R134a	R134a	R134a
Quantity of refrigerant	kg	0,950	0,950	1,100	1,100
Global Warming Potential		1430	1430	1430	1430
Carbon dioxide equivalent	t	1,359	1,359	1,573	1,573
Operation area	°C	7 / 40	7 / 40	7 / 40	7 / 40
Electrical characteristics					
Specified power of the compressor	W	350	350	490	490
Heater power ⁵⁾	W	2000	2000	2000	2000
Maximum connection power without heater/with heater	W	350/2350	350/2350	490/2490	490/2490
Voltage	V/Hz	230/50	230/50	230/50	230/50
Electrical protection	A	16	16	16	16
Moisture protection		IP21	IP21	IP21	IP21
Water tank					
Anti-corrosion protection of tank	Enamelled / Mg Anode				
Nominal pressure	MPa	0,6/0,9/1,0	0,6/0,9/1,0	0,6/0,9/1,0	0,6/0,9/1,0
The highest water temperature - heat pump	°C	65	65	65	65
The highest water temperature - electrical heater ⁵⁾	°C	75	75	75	75
Connection measurements					
Total height	mm	1860	1860	1960	1960
Width	mm	570	570	670	670
Depth	mm	585	585	685	685
Inlet/outlet water connections		G3/4	G3/4	G1	G1
Heated surface of the heat exchanger	m ²	/	1,1	/	1,1
Exchanger connectors		-	G1	-	G1
Net/gross weight/weight incl. water	kg	93/105/293	111/123/301	139/151/424	157/169/432
The temperature of the heating medium in the heat exchanger	°C	/	5 / 95	/	5 / 95
Transport data					
Packaging	mm	760x760x2060	760x760x2060	800x800x2160	800x800x2160

¹⁾ Directive 812/2013, 814/2013, EN16147:2017, indoor air 20 °C

²⁾ In accordance with EN12102:2013

³⁾ Inlet air temperature 15 °C, 74% humidity, water temperature between 10 and 55 °C in accordance with EN16147:2017

⁴⁾ Inlet air temperature 20 °C, 58% humidity, water temperature between 10 and 55 °C in accordance with EN16147:2017

⁵⁾ Model with heater

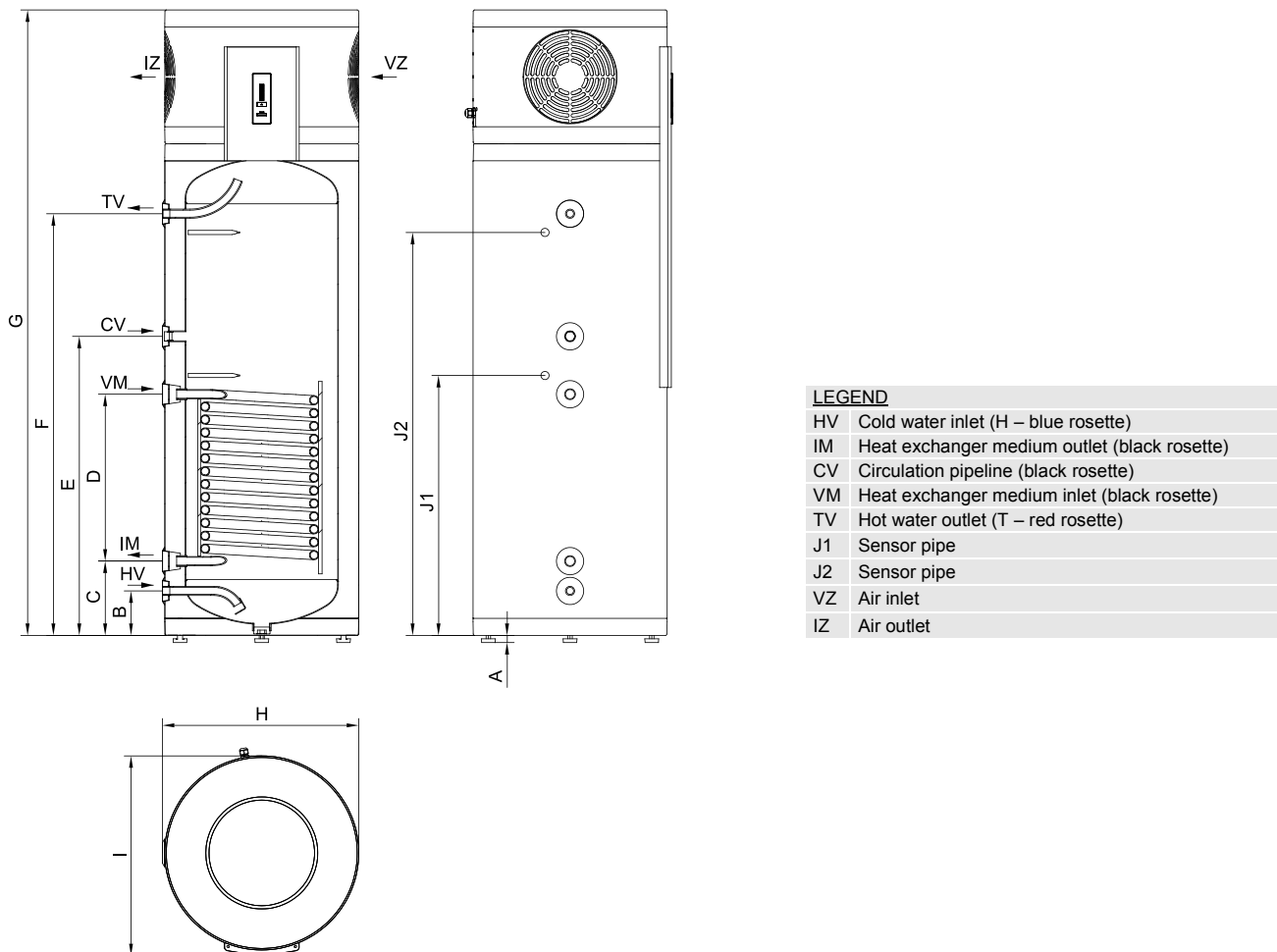

Fig. 1: Connection and installation tank dimensions [mm]

	TCM200ZG	TCM201ZG	TCM300ZG	TCM306ZG
A (mm)	25	25	25	25
B (mm)	130	130	140	140
C (mm)	/	218	/	245
D (mm)	/	490	/	490
E (mm)	880	880	880	880
F (mm)	1240	1240	1250	1250
G (mm)	1835	1835	1930	1930
H (mm)	570	570	670	670
I (mm)	585	585	685	685
J1 (mm)	/	765	/	805
J2 (mm)	/	1185	/	1185
HV	G3/4	G3/4	G1	G1
IM	/	G1	/	G1
CV	G3/4	G3/4	G3/4	G3/4
VM	/	G1	/	G1
TV	G3/4	G3/4	G1	G1

OTHER HEATING SOURCES - SENSOR INSTALLATION

On the left side of the hot water storage tank are two openings (J1, J2), where the sensors for the control system of the connection of the hot water tank to other heating sources. The maximum diameter of the probe is 8 mm. The length of the sensor tube is 180 mm. Insert the sensor into the tube and attach it:

- If the sensor is installed in the top (higher) position, then the thermostat will respond sooner, operating intervals of the circulation pump will be shorter, difference between water temperature in the hot water storage tank and the heating medium after the thermostat is switched off; as a result, the amount of hot water in the hot water storage tank will be lower.
- If you install the sensor in the bottom (lower) position, the circulation pump operating intervals will be longer, the difference between the temperature of the heating medium and the actual water temperature in the hot water storage tank will be lower, and as a result, the amount of hot water in the hot water storage tank will be greater.

INSTALLATION OF HEAT PUMP WATER HEATER

Heat pump water heater is intended for operation with surrounding air. During operation, only the energy from the air in the room where the appliance is installed is used for heating the domestic hot water. The appliance may be installed in a room where temperatures are above freezing point, preferably close to other sources of heat or heating devices, with a temperature between 7 °C and 40 °C, and minimum volume of 20 m³. In general, we recommend a sufficiently large and well-ventilated room with a temperature above 15 °C, which represents ideal conditions for heat pump operation. Desired level of air exchange for a residential building is 0.5. This means that the entire amount of air in the building is exchanged every 2 hours.

When choosing the room for installing the appliance, care should also be taken, in addition to the above instructions, that there should not be a considerable amount of dust in the room, as dust has a detrimental effect on the heat pump effect.

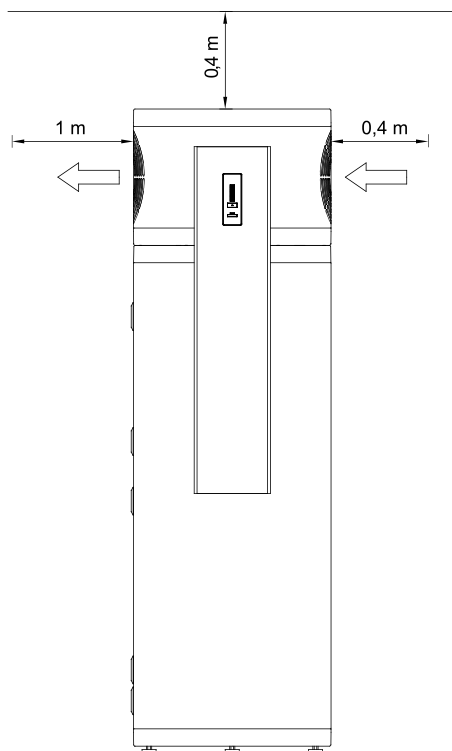

Fig. 2: Minimum requirements for installation of the appliance

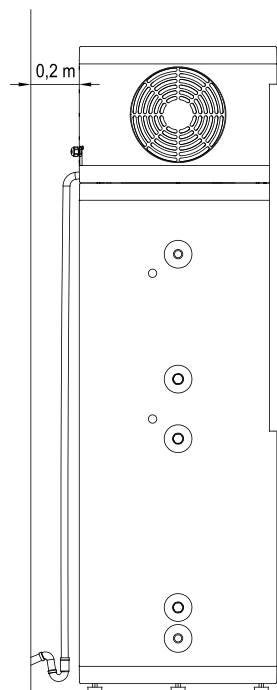

Fig. 3: Condensate discharge

During operation of the heat pump, condensate forms in the aggregate. The condensate should be drained to the sewage system via a flexible tube $\varnothing 16\text{mm}$ on the rear side of the heat pump. The quantity of condensate depends on air temperature and humidity. For easier and faster condensate drain, we recommend installing the water heater with a heat pump with a 2° inclination toward the drain hose (Fig. 3).

To reduce noise and vibrations of the installed fan, take the following steps to prevent the noise and vibrations from being transmitted through walls into rooms where it would be disturbing (bedrooms, restrooms):

- install flexible connectors for hydraulic jacks
- Install sound insulation on the floor below the heat pump to dampen the vibrations
- use support elements.

CONNECTION TO WATER SUPPLY MAINS

Connect the water pipeline system according to the attachment signs from the previous chapter (Fig. 1).

Installing a safety valve is mandatory in order to assure safe operation. The valve prevents an increase of the pressure in the boiler by any more than 0.1 MPa (1 bar) above the nominal pressure. The outflow nozzle on the safety valve must have an outlet into the atmosphere. To assure correct operation of the safety valve, check the valve regularly and, if necessary, remove the limescale and check that the safety valve is not blocked. When checking the valve, push the lever or unscrew the nut of the valve (depending on the type of the valve) and open the drain from the safety valve. Water must flow from the valve nozzle, showing that the valve operation is faultless. During the heating of water, the water pressure in the hot water storage tank is increased up to the level present in the safety valve. Since the system prevents backflow of water into the water supply mains, water may be dripping from the outlet opening on the safety valve. The dripping water may be drained via trap into the drains; the trap is mounted under the safety valve. The outlet pipe, which is mounted under the safety valve, must be directed downwards, in a place with a temperature above freezing.

If the installation does not allow draining of the water from the safety valve into the drains, dripping can be avoided by installing an expansion vessel onto the inlet pipe of the hot water storage tank. The volume of the expansion vessel must be ca. 5% of the hot water tank volume.

The hot water storage tank is designed for connection to indoor water supply mains without using the relief valve if the pressure in the supply mains is lower than prescribed on the appliance. If the pressure is higher, a relief valve needs to be installed so as to provide that the pressure at the inlet to the hot water tank does not exceed the nominal pressure.

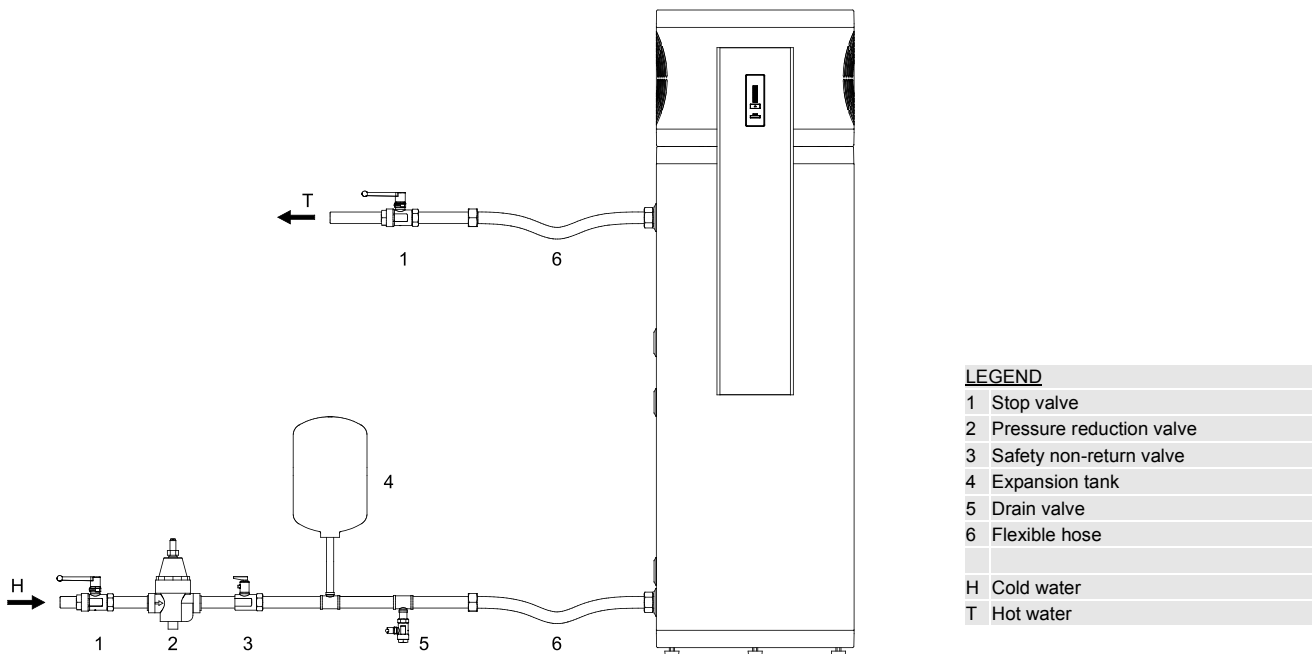

Fig. 4: Closed pressure system

⚠ To avoid damage to the heat pump power unit, the heat pump water heater must not operate without any water in the tank!

CONNECTION TO OTHER HEATING SOURCES

Heat pump water heater with a shell and tube heat exchanger in the hot water storage tank allows preparation of domestic hot water in combination with different sources of energy (e.g. central heating, solar power etc.).

Connection options to different heating sources are shown below.

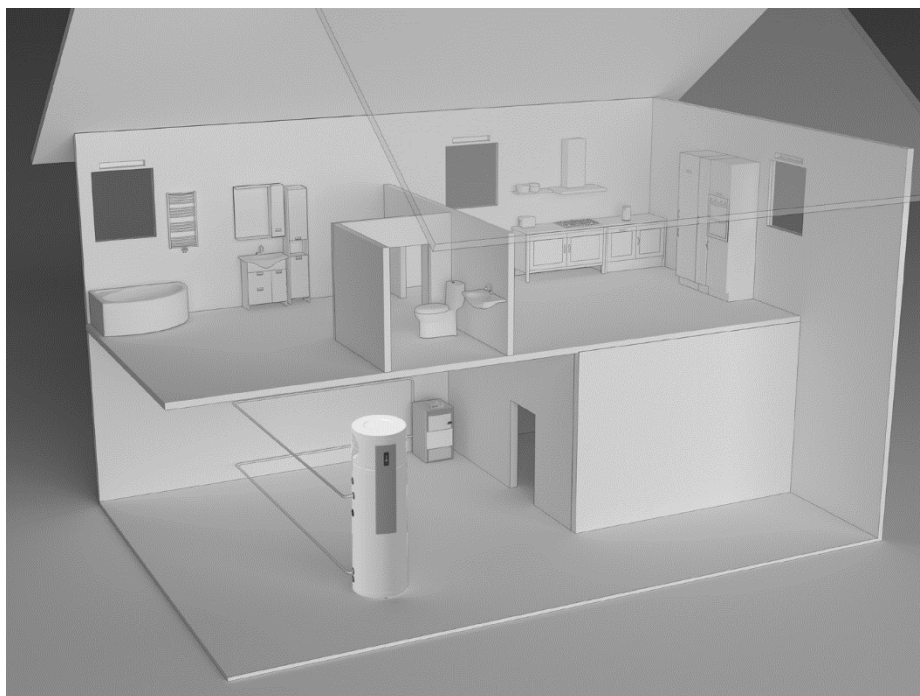

Fig. 5a: Connection to central heating

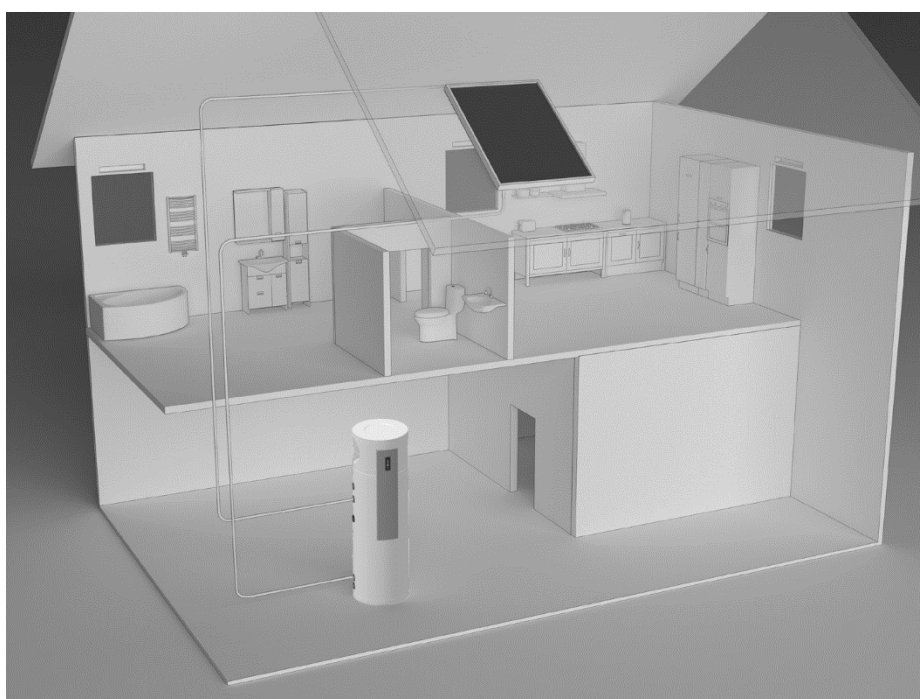
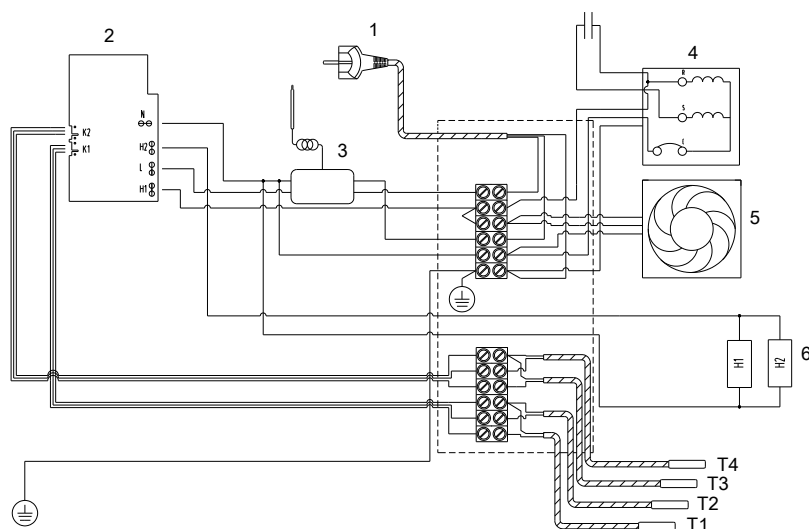

Fig. 5b: Connection to a solar collector

- ⚠ With a temperature decline of an additional heating source and with an enabled water circulation through the heat exchanger proper temperature control of the additional source must be ensured.**
- ⚠ If the additional energy source is solar power, the operation of the aggregate of the heat pump must be shut off. The combination of two heating sources can lead to overheating of the hot water and thus to excessive pressures.**
- ⚠ The circulation pipeline causes additional temperature decline in the hot water storage tank.**

CONNECTION TO THE POWER SUPPLY NETWORK

Appliance connection requires an electrical outlet suitable for current load specified in the technical information table. Connecting the appliance to the power supply network must take place in accordance with the standards for electric appliances. To comply with the national installation regulations, an all poles disconnect switch must be installed between the appliance and the power supply network.



LEGEND	
1	Power cord
2	Electronic module
3	Thermal cut-out
4	Compressor
5	Fan
6	Electrical heater
T1	Temperature sensor (electric heater)
T2	Temperature sensor (heat pump)
T3	Temperature sensor (air)
T4	Temperature sensor (evaporator)

Fig. 6: Connection to the power supply network

OPERATING THE APPLIANCE

After connecting the appliance to the water and power network and to the hot water storage tank filled with water, it is ready for operation. Upon connection to the supply voltage, the heat pump switches to standby mode. In the standby mode, the heat pump maintains a water temperature of 10 °C.

The heat pump heats the water in the range from 10 °C to 65 °C. From 65 °C to 75 °C, the water is heated by an electric heater.

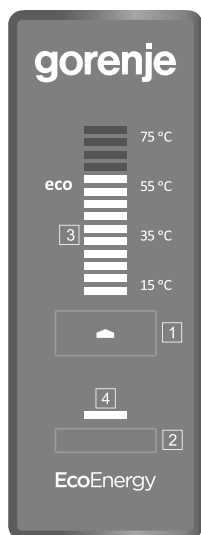

LEGEND	
1	Heat upon on/off key, water temperature setting
2	Electric heater on/off key
3	Display for set/actual water temperature in the hot water storage tank, error indicator
4	Indicator for electric heater and "TURBO" function operation

Fig. 7: Control panel

Heat pump on/off

Switch on the heat pump by pressing the **1** key and holding it (for 3 seconds). Press and hold (for 3 s) the **1** key again to switch the heat pump to standby mode.

Temperature adjustment

Use the **[1]** key to set the desired temperature (factory setting is 55 °C). Water temperature can be set in the range from 10 °C to 75 °C with 5 °C increments. When the maximum level of 75 °C is reached, the next time you press the **[1]** key, the setting returns to the minimum level of 10 °C. We recommend the "eco" setting. With this setting, water temperature will be at approximately 55 °C, and formation of limescale deposits and heat losses will be lower than at higher temperature settings. When you last press the **[1]** key, the setting is stored. After a while (approx. 5 seconds), the current temperature in the hot water storage tank is displayed on the display unit **[3]**.

If the appliance is disconnected from the power mains and there is a danger of freezing, then water has to be drained from the hot water storage tank.

The table below shows the LED lighting for respective temperature levels.

Indication	LED segment	Lighting for respective temperature levels	
		50%	100%
/	LED7 (LED1-LED6 100%)	70 °C	75 °C
/	LED6 (LED1-LED5 100%)	60 °C	65 °C
eco	LED5 (LED1-LED4 100%)	50 °C	55 °C
/	LED4 (LED1-LED3 100%)	40 °C	45 °C
/	LED3 (LED1-LED2 100%)	30 °C	35 °C
/	LED2 (LED1 100%)	20 °C	25 °C
/	LED1	10 °C	15 °C

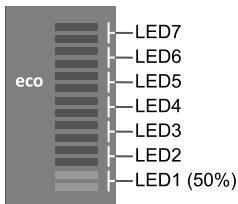

Figure 8a: Example for temperature setting at 10 °C

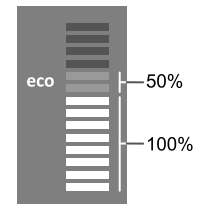

Figure 8b: Example for temperature setting at 50 °C

Power supply failure protection

In case of power supply failure, the settings remain permanently stored.

After restart, the appliance operates in the same regime as before the power supply failure.

Activation of the "TURBO" mode

This operating mode is suitable especially when you need a large amount of hot water quickly. In the "TURBO" mode, the water in the hot water storage tank is heated with the heat pump and the electric heater simultaneously. This means faster heating of water to the set temperature.

You can choose between one-off and continuous activation of the "TURBO" function.

For one-off activation, briefly press the **[2]** key. Operation in the "TURBO" mode is indicated by the indicator **[4]** which is lit until water in the hot water storage tank is heated to the set temperature. When the temperature is reached, the function is switched off automatically and the indicator **[4]** is turned off.

For constant activation, press and hold (3 seconds) the key **[2]**. Operation in the constant "TURBO" mode is indicated by the indicator **[4]** that is lit. When the temperature is reached, the function is not switched off automatically. To deactivate the function, briefly press the **[2]** key, and the indicator **[4]** will be turned off.

During operation of the "TURBO" function, the user can set the temperature, deactivate the function, and switch off the appliance.

Anti-Legionella program

If the water in the hot water storage tank is below 65 °C for 14 days, the anti-Legionella program is activated to heat the water in the hot water storage tank to a temperature of 70 °C. During the anti-Legionella program operation, respective segments will be consecutively lit on the display unit **[3]**, as indicated on Figure 9. During operation of the anti-Legionella program, temperature setting is not possible; however, the "TURBO" function can be activated and deactivated.

If the appliance is switched off or there is a power supply failure while the anti-Legionella program is in progress, the anti-Legionella program will resume when the appliance is switched back on or power supply to the appliance is restored.

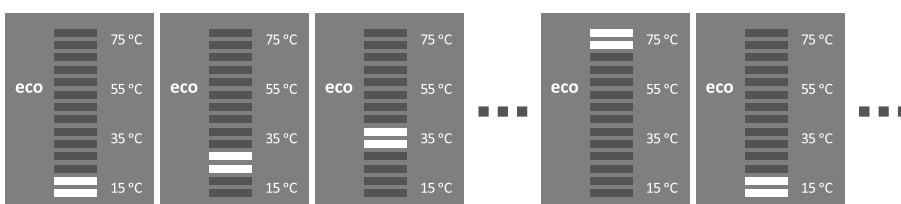

Fig. 9: Indication of the anti-Legionella program

Warning: after heating up in the anti-Legionella program, the temperature of the water in the tank is 65 °C or more, regardless of the temperature set for the appliance.

Switching the anti-Legionella program on and off

Press and hold (3 seconds) the **[1]** key to switch off the heat pump. The electronic controls switch to standby mode. Press the **[1]** key briefly for seven (7) times to display the current anti-Legionella function status. The function status is indicated by LED1 or LED7. If LED1 is lit, then the anti-Legionella program function is switched off (Figure 10b). If LED7 is lit, then the anti-Legionella program function is switched on (Figure 10a). Briefly press the **[1]** key again to change the setting. The setting is stored when the **[1]** key is not pressed for 5 seconds. The electronic controls return to standby mode. Press and hold (for 3 seconds) the **[1]** key to switch on the appliance again.

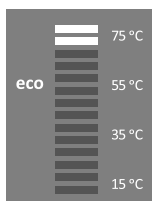

Fig. 10a: Anti-Legionella program activated

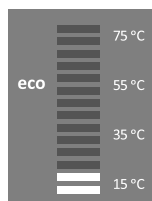

Fig. 10b: Anti-Legionella program deactivated

Backup operating mode

If the inlet air temperature is lower than 7 °C or higher than 40 °C, the appliance switches to backup operating mode. The compressor and fan do not operate, and the electric heater is switched on to heat the domestic hot water. The heat pump water heater operates in the backup operating mode. Possibility to switch to normal operating regime is checked cyclically. When the temperature conditions for normal heat pump operation are met, the appliance switches to normal operating regime. The heater is then switched off. Operation in the backup regime is indicated by the **[4]** indicator that flashes until the appliance switches to normal operating regime.

Special aspects of heat pump operation

After the heat pump is switched on, the compressor and the fan always operate for at least 5 minutes (minimum compressor operation time).

After the heat pump is switched off, the compressor and the fan are switched off for at least 20 minutes (minimum compressor down (off) time). If there is a request for compressor activation within this period of time, the compressor is not switched on. LED4 slowly flashes on the display unit **[3]** (Figure 11) (5-second interval). After the down (off) time, the compressor and the fan are switched on automatically. Current temperature level of the water in the tank is displayed on the display unit **[3]**. Temperature adjustment, activation of the "TURBO" function, and switching off of the appliance are possible while the compressor is off.

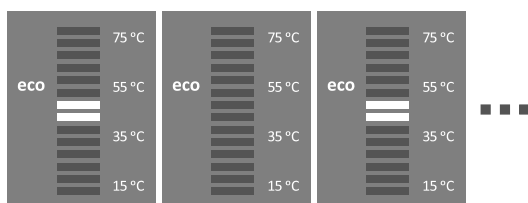

Fig. 11: Compressor unit is switched off

Error indication

In case of an error, the control lamps start flashing on the display unit **[3]**. Temperature adjustment and activation of the "TURBO" function are not possible while errors are displayed or indicated; the appliance can only be switched off.

Error	Error description	Indication	Solution
E2	Temperature sensor error (heat pump)	Repeated 2x rapid flashing of the indicator [3] .	Call service (Heat pump operates nevertheless).
E3	Temperature sensor error (electric heater)	Repeated 3x rapid flashing of the indicator [3] .	Call service (The heat pump operates, but the electric heater does not operate.)
E4	Temperature sensor error (evaporator)	Repeated 4x rapid flashing of the indicator [3] .	Call service (Heat pump operates nevertheless).
E5	Temperature sensor error (air)	Repeated 5x rapid flashing of the indicator [3] .	Call service (Heat pump operates nevertheless).
E6	Overheating (Temperature > 90 °C)	Repeated 6x rapid flashing of the indicator [3] .	Disconnect the heat pump from the power mains; call service.

If several errors occur simultaneously, they are displayed on the display unit **[3]** in succession (e.g. in case of simultaneous occurrence of errors E4 and E5, the following is displayed repeatedly: 4x rapid flashing of control lamps, pause, 5x rapid flashing of control lamps, pause).

If the errors E2 and E3 occur simultaneously, the heat pump and the electric heater do not operate.

If the errors E4 and E5 occur simultaneously, the appliance switches to back-up operating mode.

SERVICE AND MAINTENANCE

After the connection to the water supply mains and other heating sources heat pump water heater is ready for use. If there is any possibility the water in the tank could freeze, you must drain the water from the tank. To do so, open the hot water lever at one of the mixing batteries, connected to the hot water tank. The water is drained via a drain valve on the inlet water pipe.

To clean the exterior of the appliance, use a soft cloth and a mild detergent. Avoid cleaning agents containing alcohol and abrasive cleaners. If the appliance is exposed to dust, evaporator lamellas might become blocked, which can have a detrimental effect on the functioning of the appliance.

By providing regular service check-ups, you can ensure flawless operation and long life of the heat pump. The corrosion warranty for the tank only applies if you carry out regular inspections of the protective anode. The period between regular inspections should not be longer than stated in the warranty certificate. The inspection must be performed by an authorised expert. The inspection must be marked on the warranty document of the product. The inspection will check the anti-corrosion protection anode and if necessary clean the limescale, which builds up in the tank depending on the quality, quantity and temperature of water. The maintenance expert will recommend the date for the next inspection.

Despite careful production and control, errors may occur during heat pump water heater operation, which must be resolved by an authorised service technician.

Before calling your maintenance provider, check the following:

- Is everything OK with the power supply network?
- Is the air outlet obstructed?
- Is the environment temperature too low or too high?
- Can you hear the operation of the compressor and fan?

 **Do not try to eliminate malfunctions by yourself, call your nearest authorized service provider!**



Our products incorporate components that are both environmentally safe and harmless to health, so they can be disassembled as easily as possible and recycled once they reach their final life stage.

Recycling of materials reduces the quantity of waste and the need for production of raw materials (e.g. metals) which requires a substantial amount of energy and causes release of harmful substances. Recycling procedures reduce the consumption of natural resources, as the waste parts made of plastic and metal can be returned to various production processes.

For more information on waste disposal, please visit your waste collection centre or the store where the product was purchased.

WE RESERVE THE RIGHT TO ANY MODIFICATIONS NOT AFFECTING THE FUNCTIONALITY OF THE APPLIANCE.
The instructions for use are also available on our website <http://www.gorenje.com>.

