

EN

gorenje

DETAILED INSTRUCTIONS FOR USE OF UPRIGHT REFRIGERATOR AND FREEZER

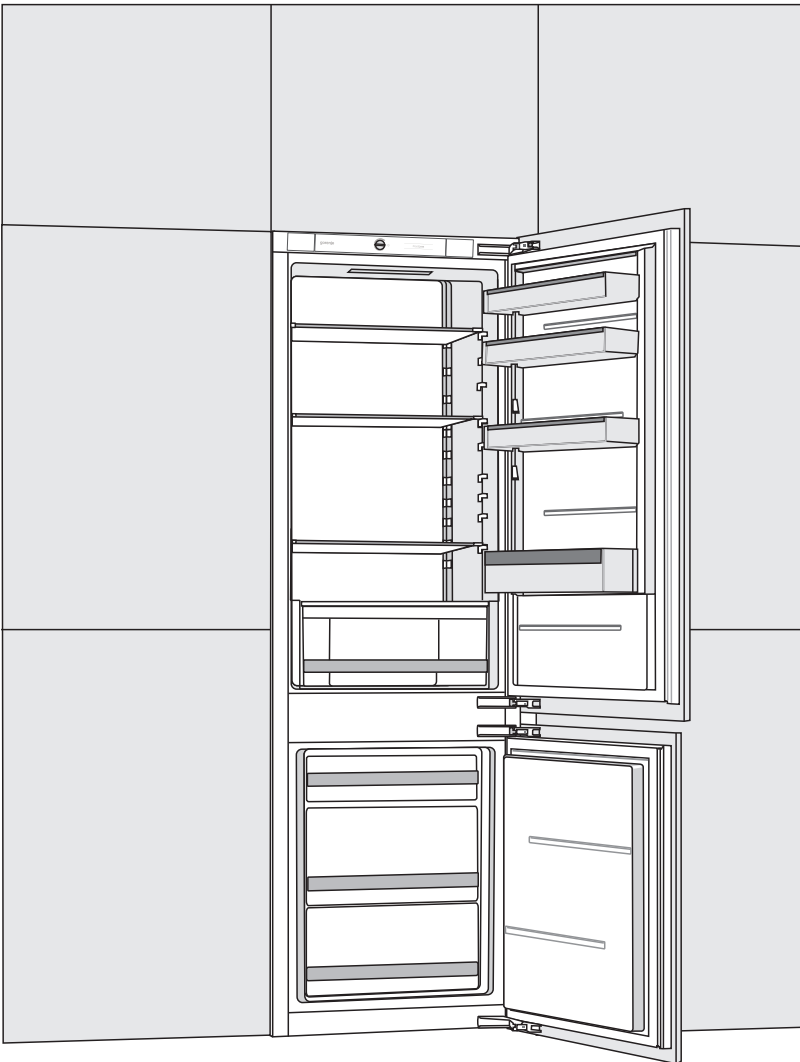

We thank you for the confidence you have shown by purchasing our appliance which is designed to simplify your life. To make the use of the product easier, we have supplied detailed instructions for use, and installation instructions supplied on a separate sheet. The instructions should allow you to learn about your new appliance as quickly as possible.

We wish you find a lot of pleasure in its use.

The appliance is intended solely for household use.

The refrigerator is intended for storing fresh food at temperatures above 0°C. **The freezer** is intended for freezing fresh food and for long-term storage of frozen food (up to one year, depending on the type of food).

Please visit our website where you can enter your appliance model number, indicated on the rating plate or the warranty sheet, to find detailed description of your appliance, tips on use, troubleshooting, service information, instructions for use etc.



<http://www.gorenje.com>

Link to the EU EPREL database

The QR code on the energy label supplied with the appliance provides a web link to the registration of this appliance in the EU EPREL database. Keep the energy label for reference together with the user manual and all other documents provided with this appliance.

It is possible to find information related to the performance of the product in the EU EPREL database using the link <https://eprel.ec.europa.eu> and the model name and product number that you can find on the rating plate of the appliance.

For more detailed information about the energy label, visit www.theenergylabel.eu.



Important safety warning



General warnings and tips



Protecting the environment



Do not wash in the dishwasher

CONTENTS

4 IMPORTANT NOTES AND PRECAUTIONS 4 BEFORE USING THE APPLIANCE FOR THE FIRST TIME 5 IMPORTANT SAFETY INSTRUCTIONS 8 IMPORTANT INFORMATION ON THE USE OF APPLIANCE 9 ENVIRONMENT PROTECTION 10 ADVICE FOR SAVING POWER WITH REFRIGERATION APPLIANCES	INTRODUCTION
11 INSTALLATION AND CONNECTION 13 APPLIANCE DESCRIPTION 14 OPERATING THE APPLIANCE 19 APPLIANCE INTERIOR EQUIPMENT 23 RECOMMENDED DISTRIBUTION OF FOOD IN THE APPLIANCE	APPLIANCE DESCRIPTION
24 STORING FOOD IN THE REFRIGERATOR 29 STORING FOOD IN THE FreshZone DRAWER 30 FREEZING AND STORING FROZEN FOOD 30 Freezing procedure 31 Important warnings on freezing 31 Storing industrially frozen food 32 Frozen food storage time 32 Defrosting frozen food	STORING AND FREEZING FOOD
33 DEFROSTING THE APPLIANCE 34 CLEANING THE APPLIANCE	DEFROSTING AND CLEANING THE APPLIANCE
35 TROUBLESHOOTING 37 INFORMATION ABOUT APPLIANCE NOISE	MISCELLANEOUS

IMPORTANT NOTES AND PRECAUTIONS

BEFORE USING THE APPLIANCE FOR THE FIRST TIME

Before connecting the appliance to the power mains, please read carefully the instructions for use which describe the appliance and its correct and safe use. The instructions apply to several appliance types/models; thus, settings or equipment may be described herein which is not available in your appliance. We recommend saving this instruction manual for future reference and attach it to the appliance if it is sold in the future.

Check for any damage or irregularities on your appliance. If you find your appliance is damaged, notify the retailer from which you have purchased the appliance.

Before connecting the appliance to the power mains, let the appliance rest in a vertical position for a minimum of 2 hours. This will reduce the possibility of operation faults due to the effect of transport on the cooling system.



IMPORTANT SAFETY INSTRUCTIONS



WARNING! Risk of fire/flammable materials.

The appliance must be connected to the power mains and grounded in compliance with the effective standards and regulations.

WARNING! Do not locate multiple portable socket-outlets or portable power supplies at the rear of the appliance.

Before cleaning the appliance, unplug it from the power mains (unplug the power cord from the wall outlet).

WARNING! If the supply cord is damaged, it must be replaced by the manufacturer, its service agent or similarly qualified persons in order to avoid a hazard.

WARNING! When positioning the appliance, ensure the supply cord is not trapped or damaged.

If LED lighting does not work, call a service technician. Do not attempt a repair of the LED lighting yourself, as there is danger of contact with high voltage!



WARNING! Do not use any electric devices inside the appliance, except for those allowed by the manufacturer of this refrigeration appliance.



WARNING! Do not use mechanical devices or other means to accelerate the defrosting process, other than those recommended by the manufacturer.



WARNING! To avoid any hazard resulting from poor stability of the appliance, make sure it is installed as instructed.

Danger of frostbite

Never put frozen food in your mouth and avoid touching frozen food as this may cause frostnip or frostbite.

Safety of children and vulnerable persons

The appliance is not intended for use by persons (including children) with reduced physical, sensory or mental capabilities, or lack of experience and knowledge, unless they have been given supervision or instruction concerning use of the appliance by a person responsible for their safety.

Children should be supervised to ensure that they do not play with the appliance.

Cleaning and user maintenance shall not be made by children without supervision.

Cleaning and user maintenance shall not be made by children without supervision.

Remove the packaging intended to protect the appliance or particular parts during transport and keep it outside the reach of children.

It presents danger of injury or suffocation.

For European markets only

This appliance can be used by children aged from 8 years and above and persons with reduced physical, sensory or mental capabilities or lack of experience and knowledge if they have been given supervision or instruction concerning use of the appliance in a safe way and understand the hazards involved.

Children shall not play with the appliance.

Cleaning and user maintenance shall not be made by children without supervision.

Children aged from 3 to 8 years are allowed to load and unload refrigerating appliances.

Warning regarding the refrigerant

The appliance contains a small amount of an environmentally friendly yet flammable gas R600a. Make sure that no parts of the cooling system are damaged. A gas leak is not hazardous to the environment, but it could cause eye injury or fire.

In case of a gas leak, ventilate the room thoroughly, disconnect the appliance from the power mains, and call a service technician.

IMPORTANT INFORMATION ON THE USE OF APPLIANCE

WARNING! This appliance is intended to be used in household and similar applications such as:

- staff kitchen areas in shops, offices and other working environments;
- farm houses and by clients in hotels, motels and other residential type environments;
- bed and breakfast type environments;
- catering and similar non-retail applications.

i WARNING! Keep ventilation openings, in the appliance enclosure or in the built-in structure, clear of obstruction.

The appliance may not be used outdoors and it may not be exposed to rain.

Do not store explosive substances such as aerosol cans with a flammable propellant in this appliance.

If the appliance will be out of use for an extended period of time, switch it off using the relevant button, and unplug it from the power mains. Empty the appliance, defrost it, clean it, and leave the door ajar.

In case of an error or power supply failure do not open the freezer compartment unless the freezer has not operated for over 16 hours. After this period, use the frozen food or provide sufficient cooling (e.g. a replacement appliance).

Technical information on the appliance

Rating plate can be found in the appliance interior. It indicates data on voltage, gross and net volume, type and amount of refrigerant, and information on the climate classes.

If the language on the rating plate is not the language of your choice or the language of your country, replace it with the one supplied.



ENVIRONMENT PROTECTION

Packaging is made of environmentally friendly materials that can be recycled, disposed of, or destroyed without any hazard to the environment.



Removing an obsolete appliance

To protect the environment, take the obsolete appliance to an authorized home appliance collection centre.

Before doing so, do the following:

- disconnect the appliance from the power mains;
- do not allow children to play with the appliance.



WARNING! Do not damage the refrigerant circuit. This will also prevent pollution.



The symbol on the product or its packaging indicates that the product should not be treated as normal household waste. The product should be taken to an authorized collection centre for waste electric and electronic equipment processing. Correct disposal of the product will help prevent any negative effects on the environment and health of people which could occur in case of incorrect product removal. For detailed information on removal and processing of the product, please contact the relevant municipal body in charge of waste management, your waste disposal service, or the store where you bought the product.



ADVICE FOR SAVING POWER WITH REFRIGERATION APPLIANCES

- Install the appliance as specified in the instruction manual.
- Do not open the door more often than necessary.
- Occasionally make sure air circulation underneath the appliance is unobstructed.
- Condenser unit on the rear wall should be kept clean (see chapter Cleaning the appliance).
- If the gasket is damaged or does not provide a perfect seal for any reason, have it replaced as soon as possible.
- Store the food in tightly sealed containers or appropriate packaging.
- Before placing the food in the refrigerator, allow it to cool down to room temperature.
- Defrost frozen food in the refrigerator compartment.
- To make use of the entire freezer compartment interior volume, remove some of the drawers as described in the instruction manual.
- Defrost your conventional freezer when an approximately 3-5 millimetre layer of frost or ice has built up on the refrigerated surfaces.
- Make sure the layout of shelves in the compartment is uniform and that the food is placed so that the air can freely circulate in the appliance interior (observe the recommended placement of food as described in the instructions).
- In appliances with a fan, do not block the fan slots or vents.
- If you do not need the fan or the ionizer, switch them off to reduce power consumption.

INSTALLATION AND CONNECTION

SELECTING THE ROOM

- Install the appliance in a dry and well ventilated room. The appliance will operate correctly if the environment temperature is in the interval specified in the table. The appliance class is indicated on the rating plate / label with the basic information on the appliance.

Description	Class	Ambient temperature range °C	Relative humidity
Extended temperate	SN	+10 to +32	≤ 75%
Temperate	N	+16 to +32	
Subtropical	ST	+16 to +38	
Tropical	T	+16 to +43	

-  • Do not place an appliance in a room where temperature can drop to below 5 °C as this may cause abnormal appliance operation or failure!
- After the installation, the appliance mains plug should be accessible!
- Do not place the appliance near appliances or devices radiating heat, such as a cooker, a stove, a radiator, water heater etc., and do not expose it to direct sunlight. The appliance should stand at least 3 cm away from an electric or gas cooker or at least 30 cm away from an oil or solid fuel stove. If the distance between such source of heat and the appliance is smaller, use an insulating panel.

Note: Place the appliance in a sufficiently large room. There should be at least 1 m³ of space per 8 grams of refrigerant. Amount of refrigerant is indicated on the rating plate in the appliance interior.

- There should be an opening or a vent of at least 200 cm² behind the appliance, and the clearance between the appliance and any cabinet above it should be at least 5 cm, to allow cooling of the condenser unit.

Note:

When installing the appliance side-by-side into kitchen cabinets, each appliance should be integrated into a separate cabinet.

An anti-condensation service kit should be purchased, complete with a power cord for connecting the kit to the power mains. An additional power socket is required for connecting the anti-condensation service kit.

For safety reasons, the service kit may only be installed by an authorized service technician!

CONNECTING THE APPLIANCE

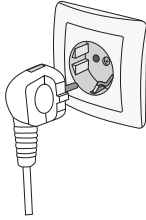

- Connect the appliance to the power mains using the power cord. The wall outlet should be fitted with a ground contact (safety socket). Nominal voltage and frequency are indicated on the rating plate/label with basic information on the appliance.
- The appliance must be connected to the power mains and grounded in compliance with the effective standards and regulations. The appliance will withstand short-term deviations from the nominal voltage, but not more than $\pm 6\%$.

CHANGING THE DOOR OPENING DIRECTION AND INTEGRATING THE APPLIANCE INTO A CABINET

The process of changing the appliance door opening and integrating the appliance into a cabinet is described on a separate sheet supplied in the bag with the instruction manual.

APPLIANCE DESCRIPTION

Appliance interior equipment may change according to the appliance model.

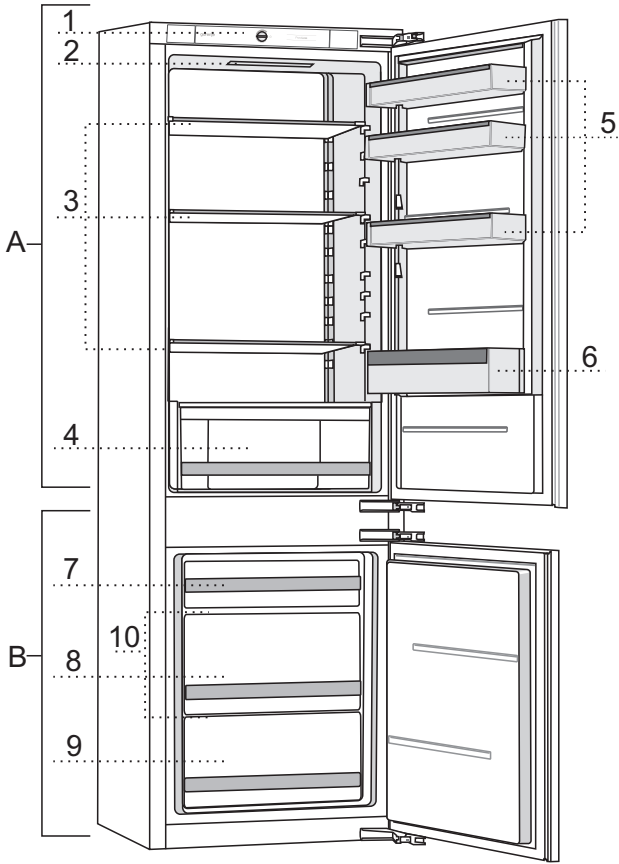

A Refrigerator

- 1 Control unit
- 2 LED lighting
- 3 Glass shelves
- 4 Fruit and vegetables drawer with humidity control
- 5 Low door shelves
- 6 Bottle shelf

B Freezer

- 7 Upper drawer
- 8 Deep drawer
- 9 Bottom drawer
- 10 Glass shelves

OPERATING THE APPLIANCE

CONTROL UNIT 1

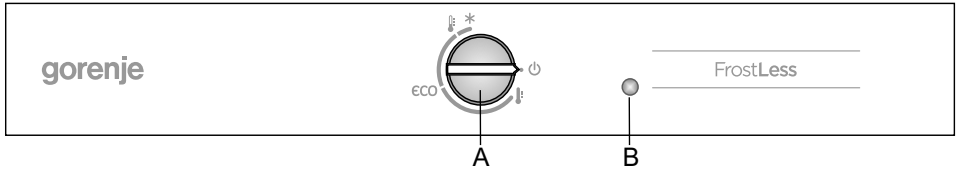

A Temperature setting and on/off knob

Use the dial to switch the appliance on or off, set the temperature, and control the ECO and intensive freezing (freezer boost) function.

B Lighting on/off key

Lighting will switch on automatically when you open the refrigerator compartment door, and it will switch off when you close it.

SWITCHING THE APPLIANCE ON/OFF

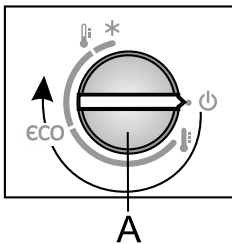



Switching on: To switch on: rotate the **A** dial clockwise.

Switching off: Rotate the **A** dial in the counter-clockwise direction until the arrow is aligned with the symbol ⏻ (Warning: appliance will remain powered, i.e. there will still be electric current in the appliance.)

ADJUSTING THE TEMPERATURE IN THE APPLIANCE

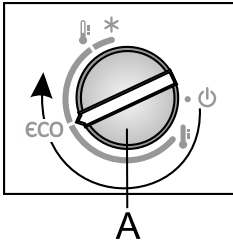
- i** • After the appliance is switched on, it may take several hours for the set temperature to be reached. Do not place any food into the refrigerator before the temperature drops to the selected setting.



- To set the desired temperature, rotate the **A** dial in clockwise direction.
- Recommended setting of the **A** dial is on the **eco** position (see figure).
- A change in the environment temperature will affect the temperature in the appliance. Adjust the setting with the **A** dial accordingly. Positions towards the  mean **a lower temperature in the appliance** (cooler). Settings towards the  mean **a higher temperature** (warmer).

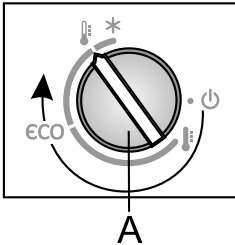

If the temperature of the room where the appliance is installed is below 16 °C, we recommend setting the **A** .

INTENSIVE COOLING AND FREEZING

- We recommend using this setting before cleaning the appliance or 24 hours before inserting a large amount of food. Activating this function will make sure the food is cooled or frozen faster to retain vitamins, minerals, nutrients, and

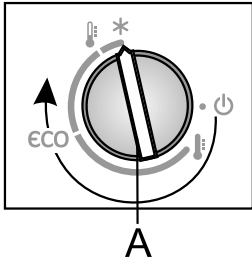

flavour, and to extend its freshness.

- **Switching on the intensive cooling and freezing:** Rotate the **A** dial to position *.
- When the intensive cooling/freezing function is activated, temperature may be lower both in the refrigerator and the freezer compartment.

- When the intensive cooling/freezing function is activated, the appliance will operate with maximum power. During this time, operation may be somewhat louder.
- After the end of the intensive cooling/freezing cycle, rotate the **A** dial back to the desired setting.

If the function is not deactivated manually, it will be deactivated automatically after approximately two days. The temperature returns to the most recently set value.

CONTROL UNIT 2

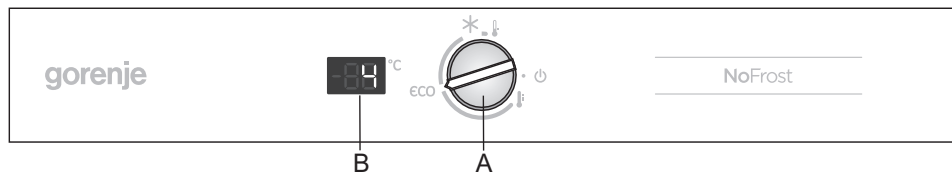

A Temperature setting and on/off dial

Use the dial to switch the appliance on or off, set the temperature, and control the ECO and intensive freezing (freezer boost) function.

B Temperature display

It displays the currently set temperature in the refrigerator compartment.

SWITCHING THE APPLIANCE ON/OFF

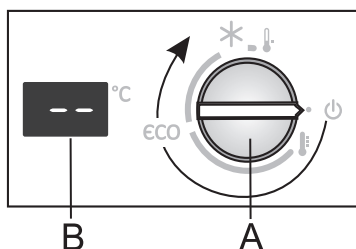

Switching on: To switch on: rotate the **A** dial clockwise.



Switching off: Rotate the **A** dial in the counter-clockwise direction until the arrow is aligned with the symbol ⏻. (Warning: appliance will remain powered, i.e. there will still be electric current in the appliance.)

ADJUSTING THE TEMPERATURE IN THE APPLIANCE

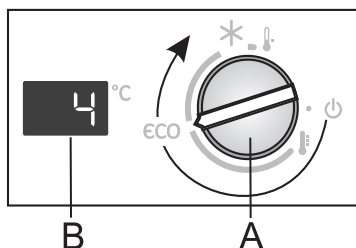
- i** After the appliance is switched on, it may take several hours for the set temperature to be reached. Do not place any food into the refrigerator before the temperature drops to the selected setting.



- To set the desired temperature, rotate the **A** dial in clockwise direction.
- Recommended setting of the **A** dial is on the **eco** position.
- With this setting, the temperature in the refrigerator compartment will be around 4 °C, and the freezer compartment temperature will be around -18 °C.

- A change in the environment temperature will affect the temperature in the appliance. Adjust the setting with the **A** dial accordingly. Positions towards the  mean **a lower temperature in the appliance** (cooler). Settings towards the  mean **a higher temperature** (warmer).

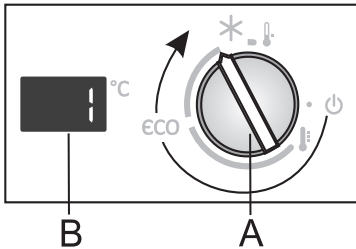

- If the temperature of the room where the appliance is installed is below 16 °C, we recommend setting the **A** dial to the position shown in the figure.

INTENSIVE COOLING AND FREEZING

- We recommend using this setting before cleaning the appliance or 24 hours before inserting a large amount of food. Activating this function will make sure the food is cooled or frozen faster to retain vitamins, minerals, nutrients, and flavour, and to extend its freshness.

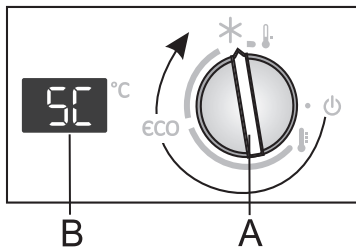

- **Switching on the intensive cooling and freezing:** Rotate the **A** dial to position *****.
- When the intensive cooling/freezing function is activated, temperature may be lower both in the refrigerator and the freezer compartment.
- When the intensive cooling and freezing function is active, the **B** display indicates »**SC**«.

- When the intensive cooling/freezing function is activated, the appliance will operate with maximum power. During this time, operation may be somewhat louder.
- After the end of the intensive cooling/freezing cycle, rotate the **A** dial back to the desired setting.

If the function is not deactivated manually, it will be deactivated automatically after approximately two days. The temperature returns to the most recently set value (the most recent setting appears on the display **B**, but the knob remains in the position *****).

REFRIGERATOR COMPARTMENT OPEN DOOR INDICATOR

If the refrigerator compartment door is open more than 2 minutes, the LED lighting will start to flash. To cancel the flashing, close the door.

APPLIANCE INTERIOR EQUIPMENT

(* EQUIPMENT DEPENDS ON THE MODEL)

SHELF

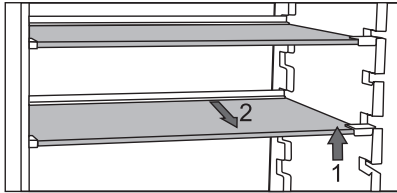

- Empty shelves can be distributed as you see fit across the guides in the refrigerator interior without having to remove the shelf from the refrigerator.

To only move the shelf to a different height/guide, lift it at the front, hold it at the back, and move it higher or lower. To take the shelf from the refrigerator, first lift it at the front part, hold it at the back part, and pull it out from the appliance. Store quickly perishable food at the back of the shelf where the temperature is the lowest.

WIRE BOTTLE RACK*

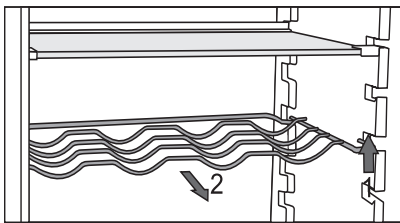

- Some models also feature a wire bottle holder. It is protected against being inadvertently pulled out. It can only be pulled out when it is empty. To pull it out, lift it slightly at the front and pull it towards you. Place the bottle holder so that the length of the bottles does not prevent proper closing of the door.

The holder can take a maximum load of 9 0.75-litre bottles or 13 kilograms of total weight – see label on the right side in the appliance interior.

- Cans may also be placed on the bottle rack (lengthwise or crosswise).

FRUIT AND VEGETABLE BIN WITH HUMIDITY CONTROL



- The bin at the bottom of the refrigerator is intended for storing fruit and vegetables. It provides humidity and prevents the food from drying out. The bin has integrated humidity regulator which allows setting the humidity level.

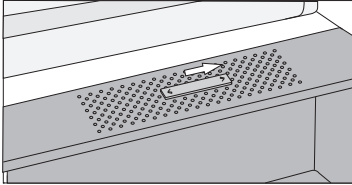

Slider position to the right: closed vents, higher humidity in the bin

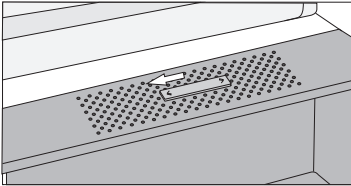

Slider position to the left: open vents, lower humidity in the bin

If you observe droplets accumulating below the glass shelf, open the vents and wipe the shelf (see chapter TROUBLESHOOTING).

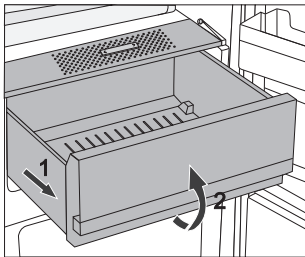

- Pulling out the bin:
 - Pull out the bin as far as it will go. Then, lift the front part and pull it out completely.

INTERIOR SIDE OF THE REFRIGERATOR DOOR

The shelves mounted on the interior side of the refrigerator door are intended for storing cheese, butter, eggs, yoghurt and other smaller packages, tubes, cans, etc. There is a bottle shelf at the lower end of the door.

ADJUSTABLE DOOR SHELVES

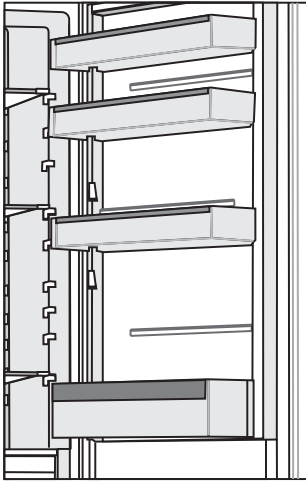

Interior side of the refrigerator door is fitted with shelves intended for storing cheese, butter, eggs, yoghurt, and other smaller packages, tubes, cans etc.

The height of the shelves is adjustable. Simply lift the shelf from the groove and place it to desired position.

Maximum load on each door shelf is 5kg.

EGG/ICE TRAY

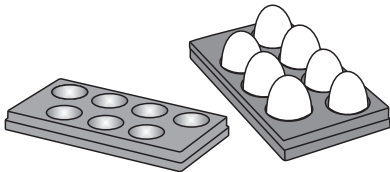

- If the tray is used as an egg tray, place it directly on the bottom of a door shelf.
- If the tray is used as an ice tray, fill it with water and place it in the freezer in a horizontal position.

FAN*

- The fan contributes to more even temperature distribution and faster cooling, and reduces dew (or condensate) accumulation on the storage surfaces.
- We recommend switching on the fan as an extra function in the following cases:
 - when the room temperature is higher (over 30 °C);
 - when humidity is higher or when dew (condensate) accumulates on the shelves;
 - when inserting a large amount of food (rapid cooling).

Note: When the fan is activated, power consumption is increased, temperature in the refrigerator is lowered, and as a result, the temperature in the freezer changes as well.

To maintain the same temperature in the refrigerator compartment as before the fan was activated, we recommend rotating the **A** knob slightly towards the **!**. Adjustment of temperature in the refrigerator directly affects the freezer temperature.

AIR IONIZER (IonAir)*

- Advanced fan system with dynamic cooling evenly distributes the ionized air and equalizes the temperature throughout the entire refrigerator. Air enriched with extra negative ions mimics the natural microclimate that keeps the food fresh for longer. Moreover, the any type of food can be placed on any shelf in the fridge as there are not temperature differences.
- To switch the air ionizer on and off , use the switch located on the fan housing.

Switching the fan and ionizer on and off::

On =  Off = **0**

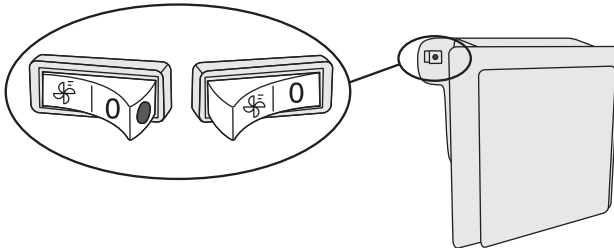

When the fan is switched on, a red dot will be visible on the switch.

RECOMMENDED DISTRIBUTION OF FOOD IN THE APPLIANCE

Sections in the refrigerator compartment:

- **Upper part:** canned food, bread, wine, pastry etc.
- **Middle part:** dairy products, ready-made meals, desserts, soft drinks, beer, cooked food, etc.
- **Fruit and vegetable bin:** fresh fruit, vegetables, salads, root vegetables, potatoes, onions, garlic, tomatoes, sauerkraut, turnips etc.



Sections in the refrigerator compartment door:

- **upper/middle door bins:** eggs, butter, cheese etc.
- **lower door bins:** beverages, cans, bottles etc.

i Do not store fruit (bananas, pineapples, papaya, citruses) and vegetables (zucchini, eggplant, cucumbers, bell peppers, tomatoes, and potatoes) sensitive to low temperatures in the refrigerator.

Freezer sections:

- freezing, storing frozen food (see chapter Freezing and storing frozen food).

i Do not store the following in the freezer: lettuce, eggs, apples, pears, grapes, peaches, yoghurt, soured milk, sour cream, and mayonnaise.

STORING FOOD IN THE REFRIGERATOR

IMPORTANT WARNINGS REGARDING FOOD STORAGE



Correct use of the appliance, appropriate packaging, maintaining the right temperature, and observing the food hygiene standards have a decisive impact on the quality of food storage.

Observe the expiry dates for the food, indicated on the packaging.

Food stored in the refrigerator should be kept in closed containers or in appropriate packaging to prevent it from emitting or receiving odours and humidity.

Do not store inflammable, volatile, and explosive substances in the refrigerator.

Bottles with high alcohol content should be tightly sealed and stored in an upright position.

Some organic solutions, essential oils in lemon and orange peel, butter acid, etc. may damage the plastic surfaces in case of a prolonged contact, causing damage and premature ageing of these materials.

Unpleasant odour warns of lacking cleanliness of the appliance or perished contents (see chapter Cleaning the Appliance).

If you are leaving home for a longer period of time, remove perishables from the refrigerator.

AVOID CONTAMINATION OF FOOD

To avoid contamination of food, please respect the following instructions:

- Opening the door for long periods can cause a significant increase of the temperature in the compartments of the appliance.
- Regularly clean surfaces that can come in contact with food and accessible drainage systems.
- Store raw meat and fish in suitable containers in the refrigerator, so that it is not in contact with or drip onto other food.
- If the refrigerating appliance is left empty for long periods, switch off, defrost, clean, dry, and leave the door open to prevent mould developing within the appliance.

STORING FOOD

TYPE OF FOOD	Optimum storage temperature (°C)	Optimum storage humidity level (%)	Approximate storage time
Pork	-1 to 4	95	3 days
Beef	0 to 4	95	up to 3 weeks
Lamb	0 to 4	95	14 days
Chicken	0 to 4	95	3 days
Fish	0 to 4	95	3 to 10 days
Mollusc	0 to 4	95	2 days
Wet-aged beef	1,5	95	16 weeks
Dairy products (yoghurt, sour cream, butter, soft cheese, cheese spreads etc.)	2 to 4	95	7 to 10 days
Beetroot	0	95	3 to 5 months
Broccoli	0	95-100	10 to 14 days
Cabbage, young	0	98-100	3 to 6 weeks
Carrots, ripe	0	98-100	4 to 5 months
Lettuce, winter	0	95-100	2 to 3 weeks
Garlic	0	65-70	6 to 7 months
Kohlrabi	0	98-100	2 to 3 months
Brussels sprouts	0	90-95	3 to 5 weeks
Cabbage, Chinese	0	95-100	2 to 3 months
Cabbage, late varieties	0	98-100	3 to 4 months
Carrots	0	95-100	2 weeks
Cauliflower	0	95-98	2 to 4 weeks
Celery, regular	0	98-100	2 to 3 months
Swiss chard	0	95-100	10 to 14 days
Radicchio	0	95-100	2 to 4 weeks
Corn, sweet	0	95-98	5 to 8 days

TYPE OF FOOD	Optimum storage temperature (°C)	Optimum storage humidity level (%)	Approximate storage time
Leeks	0	95-100	2 to 3 months
Mushrooms	0	95	3 to 4 days
Parsley	0	95-100	2 to 3 days
Parsnip	0	98-100	4 to 6 months
Radish, winter	0	95-100	2 to 4 months
Horseradish	0	98-100	10 to 12 months
Cauliflower	0 to 2	90-95	2 to 4 weeks
Onions	0 to 2	65-70	6 to 7 months
Asparagus	0 to 2	95-100	2 to 3 weeks
Peas, green	0 to 2	95-98	1 to 2 weeks
Vegetables, chopped	0 to 2	90-95	up to 5 days
Brussels sprout	0 to 2	90-95	1 to 2 weeks
Gooseberries	0 to 2	90-95	3 to 4 weeks
Cucumbers	4 to 10	95	10 to 14 days
Potatoes	7 to 10	90-95	up to 9 months
Avocado, unripe	7 to 10	85-95	up to 6 weeks
Bell peppers	7 to 10	90-95	2 to 3 weeks
Tomatoes	10 to 12	85-90	4 to 7 days
Beans, seeds	< 15	40-50	6 to 10 months
Pears	-3	90-95	2 to 7 months
Apricots	-1	90-95	1 to 3 weeks
Strawberries	0	90-95	3 to 7 days
Raspberries	0 to 2	90-95	2 to 3 days
Currants	0 to 2	90-95	1 to 4 weeks
Blueberries	0 to 2	90-95	14 days
Cherries	0 to 2	90-95	2 to 3 weeks
Grapes	0 to 2	85	2 to 8 weeks
Kiwi, ripe	0 to 2	90-95	1 to 3 months
Peaches	0 to 2	90-95	2 to 4 weeks

TYPE OF FOOD	Optimum storage temperature (°C)	Optimum storage humidity level (%)	Approximate storage time
Cherries	0 to 2	90-95	2 to 3 weeks
Kiwi, unripe	0 to 2	90-95	2 to 6 months
Nectarines	0 to 2	90-95	1 to 3 weeks
Oranges	0 to 2	90-95	2 to 4 weeks
Persimmon	0 to 2	90-95	2 to 3 months
Plums	0 to 2	90-95	2 to 5 weeks
Fruit, chopped	0 to 2	90-95	up to 10 days
Apples	0 to 4	90-95	1 to 12 months
Melons	4	90-95	15 days
Oranges	4 to 7	90-95	2 to 4 weeks
Tangerines	5 to 8	90-95	2 to 4 weeks
Mango	10 to 13	85-95	2 to 3 weeks
Melons	10 to 13	85-95	1 to 2 weeks
Pineapples	10 to 13	85-95	2 to 4 weeks
Lemons	11 to 13	90-95	2 to 3 weeks
Watermelon	12 to 15	85-95	1 to 3 weeks
Bananas, ripe	13 to 16	85-95	3 days
Grapefruit	13 to 16	90-95	1 to 3 weeks

STORING FOOD IN THE FreshZone DRAWER

(Only some models are fitted with this drawer)

In the **FreshZone** compartment, food stays fresh longer than in a conventional refrigerator, retaining more flavour and nutrients.

Decay and loss of mass are slowed down; therefore, fruit and vegetables remain fresh and natural longer. For optimum performance, the drawer should be fully closed.

- When buying food, make sure it is fresh as this will determine the quality of the food, as well as how long it will keep in the fridge.
- Store the food in closed containers or appropriate packaging to prevent it from emitting or receiving odours.
- Take the food from the drawer 30 to 60 minutes before use to allow the aroma and flavour develop at room temperature.
- Food sensitive to low temperature and not appropriate for storage in the FreshZone drawer includes the following: pineapples, avocado, bananas, olives, potatoes, eggplant, cucumbers, beans, peppers (capsicum), melons, watermelons, pumpkins, squash, zucchini etc.

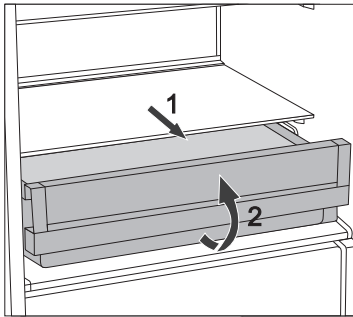

- To remove the drawer:
 - Pull out the drawer until it is blocked.
 - Lift it at the front and pull out completely.

FREEZING AND STORING FROZEN FOOD

FREEZING PROCEDURE



Maximum amount of fresh food that may be inserted at once is specified on the appliance rating plate. If the amount of food to be frozen exceeds the indicated amount, the quality of freezing will be inferior; in addition, the quality of the food already frozen will deteriorate.

- To make use of the entire freezer volume, remove all drawers. Place the food directly on the shelves and on the freezer bottom. With NoFrost appliances of the A+++ energy class, leave the bottom drawer in the appliance.
- Activate the super freeze function 24 hours before freezing fresh food:
 - Rotate the **A** dial to position ✱.

Then, insert the fresh food into the freezer compartment.

Make sure the fresh food is not in contact with the food that is already frozen. The most suitable place for freezing a large amount of fresh food is the upper section of the freezer.

- When freezing smaller amounts of food (1-2 kilograms), activating the super freeze function is not required.
- After 24 hours, the food can be moved to other freezer compartments and the freezing process can be repeated as necessary.
- After the freezing process, rotate the **A** knob back to the desired setting.

If the dial is not turned manually, intensive freezing will be switched off after approximately two days. The temperature will return to the most recent setting.

IMPORTANT WARNINGS ON FREEZING



Only use the freezer to freeze food appropriate for freezing. Always use quality and fresh food.

Select the most suitable packaging for the food and use the packaging correctly.

Make sure the packaging is air and water tight so that the food does not dry out and lose its vitamins.

Indicate the type of food, amount, and date of freezing on the packaging.

It is important that the food freezes quickly. Therefore, smaller packages are recommended. Refrigerate the food before freezing.

STORING INDUSTRIALLY FROZEN FOOD

- When storing and using frozen food, observe the manufacturer's instructions. Temperature and expiry date are indicated on the packaging.
- Only choose food with undamaged packaging, stored in freezers at temperatures of $-18\text{ }^{\circ}\text{C}$ or lower.
- Do not purchase food covered in frost as this indicates it has been partly thawed several times and that it is of inferior quality.
- Protect the food from thawing during transport. In case of an increase in temperature, storage time will be shorter and quality will deteriorate.

FROZEN FOOD STORAGE TIME

RECOMMENDED STORAGE TIME IN THE FREEZER

Type of food	Time
fruit, beef	from 10 to 12 months
vegetables, veal, poultry	from 8 to 10 months
Venison	from 6 to 8 months
Pork	from 4 to 6 months
finely chopped or ground meat	4 months
bread, pastry, cooked meals, lean fish	3 months
entrails	2 months
smoked sausage, fatty fish	1 month

DEFROSTING FROZEN FOOD

Freezing the food does not kill the microorganisms. After the food is defrosted or thawed, bacteria are re-activated and the food spoils quickly. Use the partially or completely defrosted food as soon as possible.

Partial thawing decreases the nutritive value of the food, particularly fruit, vegetables, and ready-to-eat food.

DEFROSTING THE APPLIANCE

AUTOMATIC REFRIGERATOR DEFROSTING

Refrigerator does not need defrosting because the ice on the back interior wall is thawed automatically.

Any accumulated ice will melt when the compressor unit is inactive. Drops will flow through an opening in the refrigerator rear wall into a tray fitted above the compressor, from where they will evaporate.

Make sure the opening in the back wall in the refrigerator interior is never blocked by food or any other object.

If an excessive layer of ice is formed on the rear wall of refrigerator interior (3-5 mm), switch off the appliance and defrost the appliance manually.

DEFROSTING A CONVENTIONAL FREEZER

- Defrost the freezer when an approximately 3-5 millimetre layer of frost or ice has built up.
- 24 hours before defrosting, activate the super freeze function to additionally cool the food (see section Freezing procedure).

After this period, remove the food from the freezer and protect them from defrosting.

- Switch off the appliance (see chapter Switching the appliance on/off) and unplug the power cord.
- Do not use a knife or any other sharp object to remove the frost, as you may damage the cooling system.
- Do not use a knife or any other sharp object to remove the frost, because you may damage a pipe of the cooling system.
- To speed up the defrosting process, place a pot of hot water on the glass shelf.
- Clean and dry the appliance interior (see chapter Cleaning the Appliance).

DEFROSTING A NO FROST FREEZER

- The NO FROST freezer will defrost automatically. Occasional frost that may appear on the walls will disappear automatically.
- Build-up of ice or frost in the freezer compartment can be a result of abnormal use of appliance (door opened too frequently and/or too long, door not properly closed etc.). In this case, unplug the appliance, remove the food from the freezer and protect them from defrosting. Clean and dry the freezer interior. Before returning the frozen food into the freezer, switch on the appliance and select the desired setting.

CLEANING THE APPLIANCE



Before cleaning, unplug the appliance from the power mains – switch off the appliance (see chapter Switching the Appliance On/Off) and unplug the power cord from the wall outlet.

- Use a soft cloth to clean all surfaces. Cleaners that contain abrasive substances, acids, or solvents are not suitable for cleaning as they may damage the surface.

Clean the appliance **exterior** with water or a mild solution of suds. Lacquer-coated and aluminium surfaces may be cleaned with lukewarm water to which you have added a mild detergent. Use of cleaners with low alcohol content is allowed (e.g. window cleaners). Do not use cleaners containing alcohol for cleaning plastic materials.



Appliance **interior** can be cleaned with lukewarm water to which you can add some **vinegar**.



- Do not wash the parts of appliance interior equipment in a dishwasher as they may be damaged.

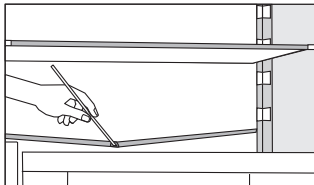

- A gutter and an opening for discharging the water from thawed frost deposits are located underneath the cooling panel that cools the refrigerator interior. The gutter and the opening may not be clogged. Inspect them often and clean if necessary (e.g. with a plastic straw).
- Frost or ice build-up, 3-5 mm thick, will increase power consumption. Therefore, it should be regularly removed (does not apply to NO FROST freezers). Do not use any sharp objects, solvents, or sprays.

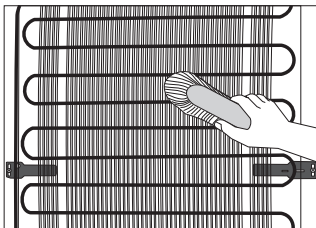

- **The condenser** unit mounted on the (exterior) back wall should always be kept clean, free of dust or deposits resulting from kitchen smoke or fumes. Occasionally clean the dust using a soft non-metal brush or a vacuum cleaner.
- After cleaning, switch the appliance back on and insert the food.

TROUBLESHOOTING

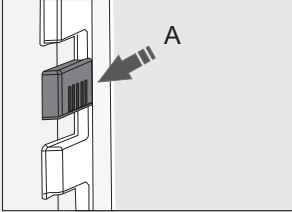
Problem:	Cause or remedy
Appliance is connected to the power mains but it does not work.	<ul style="list-style-type: none"> • Make sure there is voltage in the power outlet and that the appliance is switched on.
Cooling system operates continuously for a long period of time: 	<ul style="list-style-type: none"> • Too high environment temperature. • Door opened too frequently or too long. • Door not closed correctly (possible impurities on the seal, misaligned door, damaged seal etc.). • Too much fresh food inserted at once. • Sensor in the refrigerator (A) blocked by fresh food. Make sure the air can circulate around the sensor (only with some models). • Insufficient compressor and condenser unit cooling. Check for sufficient air circulation behind the appliance and clean the condenser unit.
Excessive build-up of ice on the back wall of refrigerator interior can be a result of the following:	<ul style="list-style-type: none"> • Door opened too frequently or too long. • Warm food placed in the refrigerator. • Food or containers in contact with the back interior wall of the refrigerator. • Poor door sealing. • If the seal is dirty or damaged, clean or replace it.
Build-up of ice or frost in the freezer interior may be a result of the following:	<ul style="list-style-type: none"> • Door opened too frequently or too long. • Door not properly closed. • Poor door sealing. • If the seal is dirty or damaged, clean or replace it.
Condensate (dew) on the shelf above the drawers:	<ul style="list-style-type: none"> • This is transient phenomenon which cannot be entirely avoided in periods of high environment temperature and humidity. It subsides when temperature and humidity are normalized. We recommend cleaning the drawers more frequently and wiping the droplets occasionally. • Open the humidity control slider. • Place the food in to bags or other airtight packaging.
Water is dripping/leaking from the refrigerator:	<ul style="list-style-type: none"> • Clogged water discharge opening or water dripping past the water gutter. • Clean the blocked opening, e.g. using a plastic straw. • If a thick layer of ice builds up, defrost the appliance manually (see Defrosting the Appliance).

Problem:	Cause or remedy
Door is difficult to open:	<ul style="list-style-type: none"> • If you are trying to open the freezer door after just having closed it, this could be difficult to do. As you open the door, some cool air escapes from the appliance and it is replaced by warm air from the environment. When this air is cooled, negative pressure is generated which results in problems as you try to open the door. After a few minutes, the condition is normalized and the door can be easily opened again.
LED lighting does not work:	<ul style="list-style-type: none"> • Refrigerator compartment door may have been open for too long. Try closing and re-opening the door. • If LED lighting still does not work, call a service technician. • Do not attempt a repair of the LED lighting yourself, as there is danger of contact with high voltage!

If the above tips do not resolve your problem, call the nearest authorized service centre and state the type, model, and serial number indicated on the appliance rating plate or label located in the appliance interior.

INFORMATION ABOUT APPLIANCE NOISE

Cooling in refrigerator freezers is made possible by a cooling system that also includes a compressor (and a fan with some appliances), which generates some noise. The level of noise depends on installation, proper use, and age of the appliance.

- After connecting the appliance to the power mains, compressor operation, or the sound of flowing liquid, may be somewhat louder. This is not a sign of malfunction and it will not affect the useful life of the appliance. In time, appliance operation and this noise will become quieter.
- Sometimes, unusual or loud noises may appear during appliance operation; these are mostly the result of improper installation:
 - The appliance must stand level and stable on a solid base.
 - The appliance may not be in contact with a wall or adjacent furniture.
 - Make sure the interior equipment sits firmly in its place and that the noise is not caused by rattling cans, bottles or other containers placed next to each other.
- Due to the higher workload on the cooling system when the door is opened more frequently or for a longer time, when a large amount of fresh food is introduced or when intensive freezing or cooling functions are activated, the appliance can temporarily generate more noise.

WE RESERVE THE RIGHT TO CHANGES THAT DO NOT AFFECT THE APPLIANCE FUNCTIONALITY.

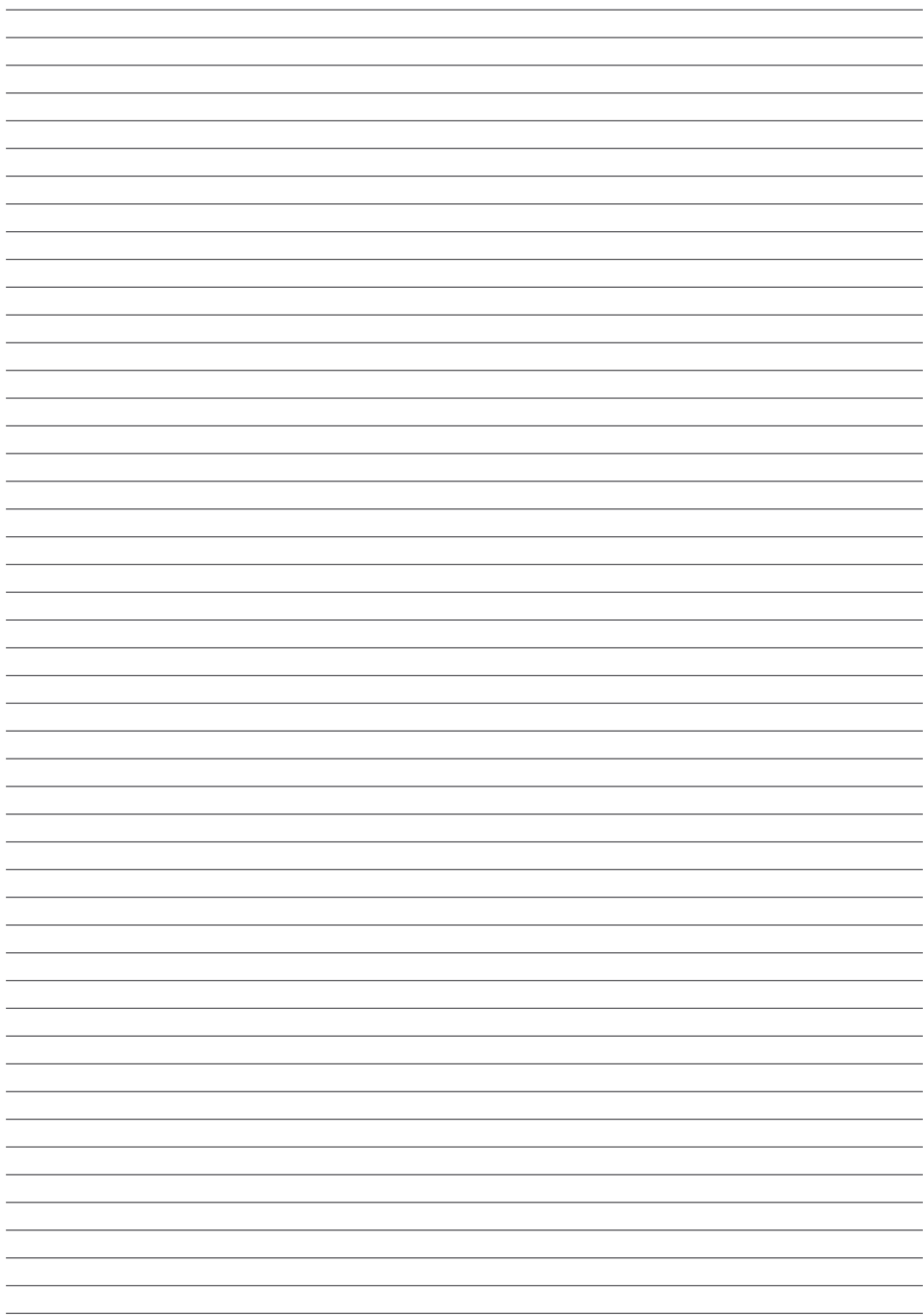

COMBI BI540 ESS



564569

en (01-21)