

gorenje⁺

DETAILED INSTRUCTIONS
FOR USE OF THE
ELECTRIC OVEN

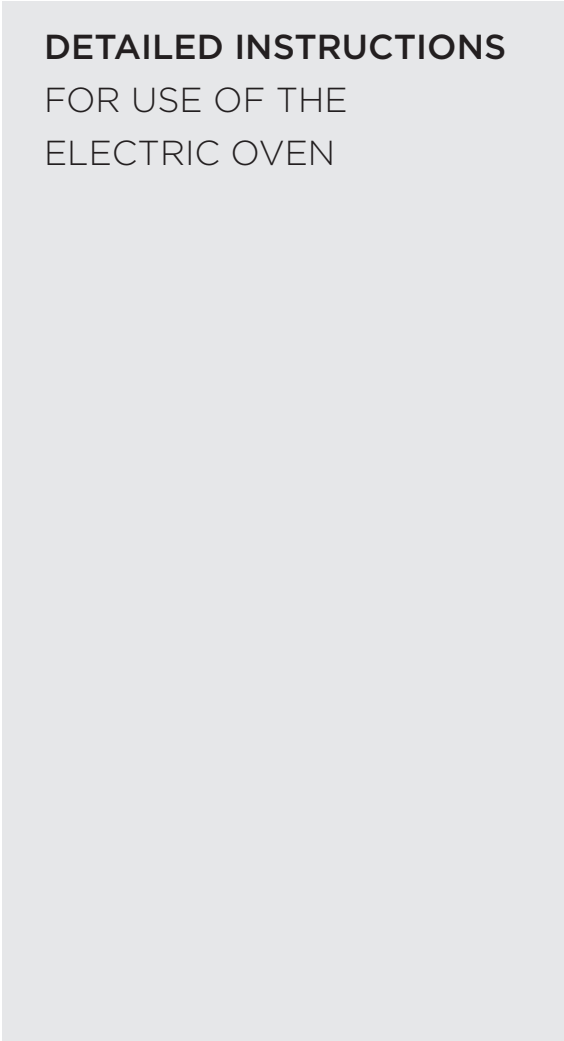

We thank you for your trust in purchasing our appliance.

This detailed instruction manual is supplied to allow you to learn about your new appliance as quickly as possible.

Make sure you have received an undamaged appliance. Should you notice any transport damage, please notify your dealer or regional warehouse where your appliance was supplied from. The telephone number can be found on the invoice or on the delivery note.

Instructions for installation and connection are supplied on a separate sheet.

Instructions for use are also available at our website:

www.gorenje.com / <http://www.gorenje.com> />



Important information



Tip, note

CONTENTS

4 IMPORTANT SAFETY INSTRUCTIONS 5 Before connecting the appliance	WARNINGS
6 THE ELECTRIC OVEN 9 Information on the appliance - data plate (depending on the model) 10 Control unit	INTRODUCTION
12 BEFORE THE FIRST USE 13 FIRST USE	INITIAL PREPARATION OF THE APPLIANCE
14 SELECTING THE MAIN MENUS FOR BAKING AND SETTINGS 15 A) Baking by selecting the type of food (automatic mode auto) 17 B) Baking by selecting the mode of operation (professional (pro) mode) 23 C) Storing your own programme (my mode) 24 START OF BAKING 24 END OF BAKING AND OVEN SHUT-OFF 25 SELECTING ADDITIONAL FEATURES 27 SELECTING GENERAL SETTINGS 29 DESCRIPTIONS OF SYSTEMS (COOKING MODES) AND COOKING TABLES	SETTINGS AND BAKING
44 MAINTENANCE & CLEANING 45 Conventional oven cleaning 46 Aqua clean cleaning program 47 Removing and cleaning wire and telescopic extendible guides 48 Removing and inserting the oven door 50 Removing and inserting the oven door glass pane 51 Replacing the bulb	CLEANING AND MAINTENANCE
52 TROUBLESHOOTING TABLE 53 DISPOSAL	PROBLEM SOLVING

IMPORTANT SAFETY INSTRUCTIONS



CAREFULLY READ THE INSTRUCTIONS AND SAVE THEM FOR FUTURE REFERENCE.

This appliance can be used by children aged from 8 years and above and persons with reduced physical, sensory or mental capabilities or lack of experience and knowledge if they have been given supervision or instruction concerning use of the appliance in a safe way and understand the hazards involved. Children shall not play with the appliance. Cleaning and user maintenance shall not be made by children without supervision.

WARNING: The appliance and its accessible parts become hot during use. Care should be taken to avoid touching heating elements. Children less than 8 years of age shall be kept away unless continuously supervised.

WARNING: Accessible parts may become hot during use. Young children should be kept away.

During use the appliance becomes hot. Care should be taken to avoid touching heating elements inside the oven.

Only use the temperature probe recommended for use in this oven.

WARNING: Ensure that the appliance is switched off before replacing the lamp to avoid the possibility of electric shock.

Do not use harsh abrasive cleaners or sharp metal scrapers to clean the oven door glass/ the glass of hinged lids of the hob (as appropriate), since they can scratch the surface, which may result in shattering of the glass.

Do not use steam cleaners or high pressure cleaners to clean the appliance as this may result in an electric shock.

The appliance is not intended to be controlled with external timers or special control systems.

Means for disconnection must be incorporated in the fixed wiring in accordance with the wiring rules.

If the supply cord is damaged, it must be replaced by the manufacturer, its service agent or similarly qualified persons in order to avoid a hazard.

The appliance must not be installed behind a decorative door in order to avoid overheating.

The appliance is intended for household use. Do not use it for any other purpose, such as room heating, drying of pets or other animals, paper, fabrics, herbs etc. As this may lead to injury or fire hazard.

The appliance may only be connected to the power mains by an authorized service technician or expert. Tampering with the appliance or nonprofessional repair thereof may result in risk of severe injury or damage to the product.

If the power cords of other appliances located near this appliance are caught in the oven door, they may be damaged, which may in turn result in a short circuit. Therefore, keep the power cords of other appliances at a safe distance.

Do not line the oven walls with aluminium foil and do not place baking trays or other cookware on the oven bottom. Aluminium foil would prevent air circulation in the

oven, hinder the cooking process, and ruin the enamel coating.

Oven door become very hot during operation. A third glass is installed for extra protection, reducing the temperature of the outside surface (only with some models).

Oven door hinges may be damaged when under excessive load. Do not place heavy pans on open oven door and do not lean against open oven door when cleaning the oven cavity. Never stand on the open oven door and do not let children to sit on it.

Do not lift the appliance by holding it by the door handle.

Appliance operation is safe with and without tray guides.

Make sure the vents are never covered or obstructed in any other way.

BEFORE CONNECTING THE APPLIANCE



Carefully read the instructions for use before connecting the appliance. Repair or any warranty claim resulting from incorrect connection or use of the appliance shall not be covered by the warranty.

THE ELECTRIC OVEN

(DESCRIPTION OF THE OVEN AND EQUIPMENT - DEPENDING ON THE MODEL)

The figure represents one of the built-in appliance models. Since the appliances for which these instructions were drawn up may have different equipment, some functions or equipment may be described in the manual that may not be present in your appliances.

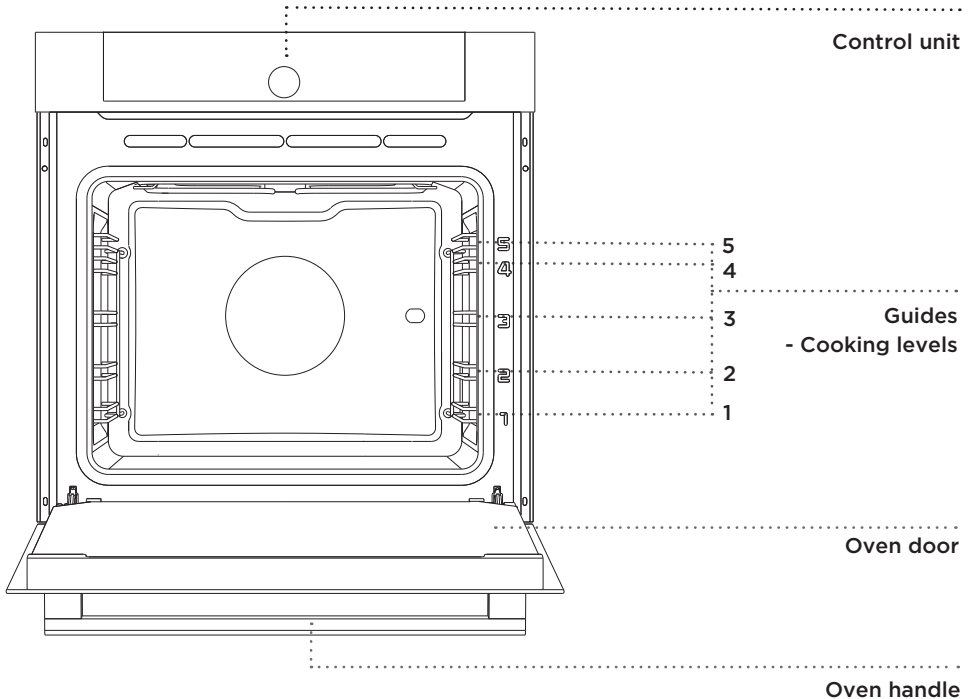

WIRE GUIDES

The wire guides allow preparation of the food on 5 levels (please note that the levels/ guides are counted from the bottom up).

Guides 4 and 5 are intended for grilling.

TELESCOPIC PULL-OUT GUIDES

Telescopic pull-out guides can be installed on the 2nd, 3rd and 4th level. Pull-out guides can be partially or completely extractable.

OVEN DOOR SWITCH

The switches deactivate oven heating and the fan when the oven door is opened during the cooking process. When the door is closed, the switches turn the heaters back on.

COOLING FAN

The appliance is fitted with a cooling fan that cools the housing and the appliance control panel.

EXTENDED OPERATION OF THE COOLING FAN

After the oven is switched off, the cooling fan continues to operate for a short while in order to cool the oven. (Extended cooling fan operation depends on the temperature in the center of the oven).

OVEN EQUIPMENT AND ACCESSORIES (depending on the model)

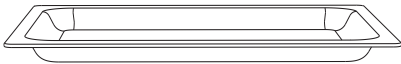

GLASS BAKING DISH is used for cooking with all oven systems. It can also be used as a serving tray.



The **GRID** is used for grilling or as support for a pan, baking tray or baking dish with the food.



There is a safety latch on the grid. Therefore, lift the grid slightly at the front when pulling it out from the oven.

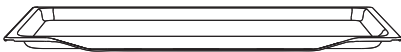

The **SHALLOW BAKING SHEET** is used for baking pastry and cakes.

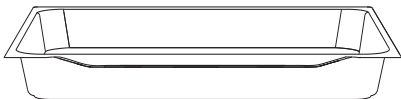

The **DEEP BAKING TRAY** is used for roasting meat and baking moist pastry. It can also be used as a drip tray.



Never place the deep baking tray in the first guide during the cooking process, except when grilling food or using the roasting spit and you are only using the deep tray as a drip tray



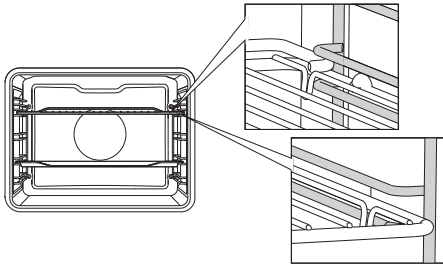

As baking accessories heat up, their form may change. This does not affect their functionality and their original form will be restored when they cool down.

The grid or the tray should always be inserted into the groove between the two wire profiles.

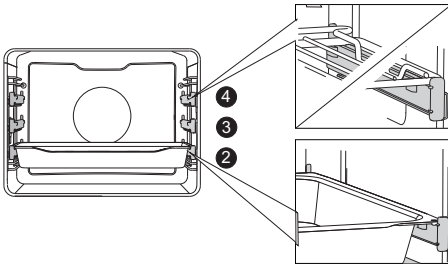

With telescopic extendible guides, first pull out the guides of one level and place the grid or the baking tray onto them. Then, push them in with your hand as far as they will go.



 Close the oven door when the telescopic guides are retracted all the way into the oven.

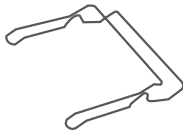

BAKING TRAY HOLDER makes it easier to remove hot baking trays from the oven after baking.

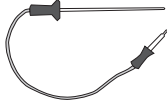

Meat temperature probe



ROTISSERIE is used for baking meat. The kit consists of the rotisserie stand, the rotisserie with screws and a removable handle.



The appliance and some of the accessible parts tend to heat up during cooking. Use oven mitts.

INFORMATION ON THE APPLIANCE - DATA PLATE (DEPENDING ON THE MODEL)

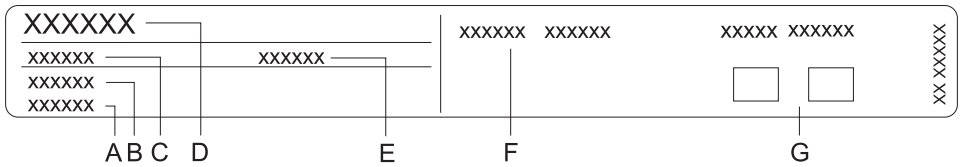

- A Serial number
- B Code
- C Type
- D Brand
- E Model
- F Technical data
- G Compliance symbols

The rating plate indicating the basic information about the appliance is located at the edge of the oven and it is visible when the oven door is opened.

CONTROL UNIT

(depending on the model)

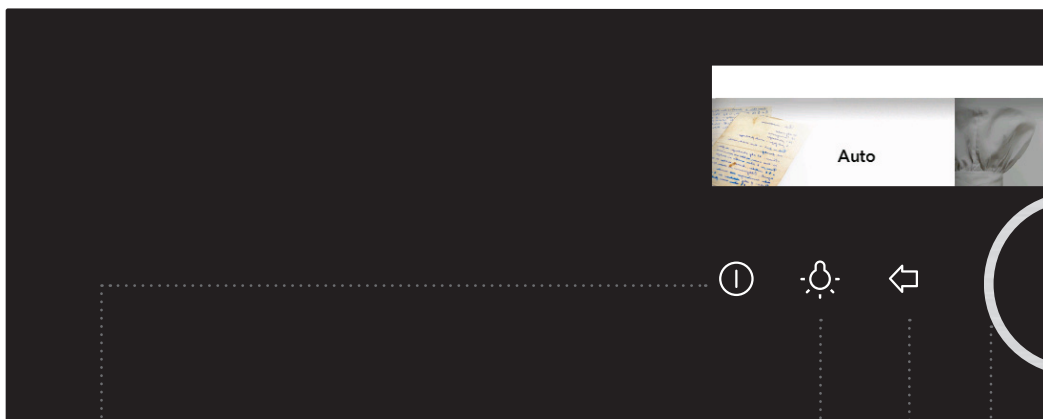
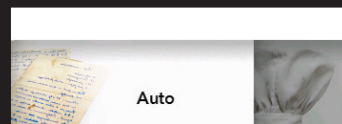

1 ON/OFF KEY

2 OVEN
LIGHTING ON/
OFF KEY

3 BACK KEY

4 Selection and
CONFIRMATION
KNOB

Touch briefly to
return to previous
menu.

Touch and hold to
return to main menu.

Select the setting by
rotating the knob.

**Confirm your
selection** by pressing
the knob.

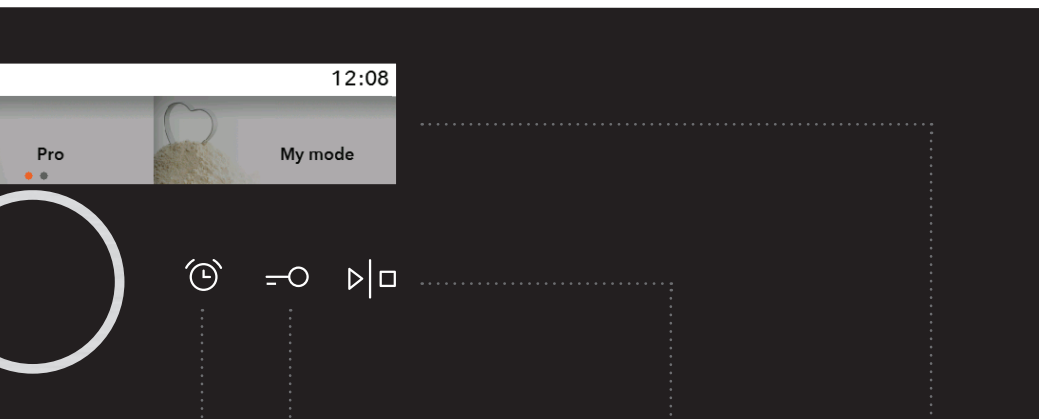

5 MINUTE
MINDER/
ALARM

6 CHILD LOCK
KEY

7 START/STOP
KEY

8 DISPLAY - displays
all settings

Long touch: START

**Long touch during
operation:** STOP

NOTE:

The keys will respond better if you touch them with a larger area of your fingertip. Each time you touch a key, this will be acknowledged by a short acoustic signal.

BEFORE THE FIRST USE

Before the first use, remove all components, including any transport equipment, from the oven. Clean all accessories and utensils with warm water and regular detergent. Do not use any abrasive cleaners.

Before using the oven the first time, heat it without any food, in the system “upper and bottom heater”, at the temperature of 200 °C for approximately one hour. The characteristic smell of a “new appliance” will be emitted. Ventilate the room thoroughly during the first use.

FIRST USE

LANGUAGE SELECTION

Upon the first connection of the appliance to the power supply or after a prolonged period of being disconnected, please set the desired language. The default language is English.

 Confirm each setting by pressing the KNOB.



Turn the KNOB and select the desired language. Confirm your selection.

SETTING THE DATE

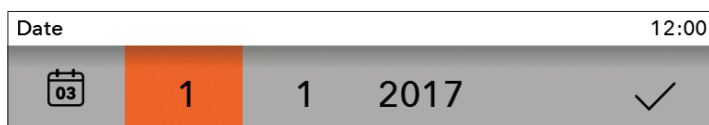

By pressing the KNOB set the DAY, MONTH and YEAR. Turn the knob and confirm your selection with a check mark.

SETTING THE CLOCK

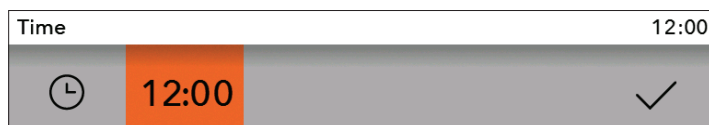

Turn the KNOB and set the CLOCK. Confirm your selection with a check mark.

 The oven also if you do not set the time of day, but in this case it is not possible to set the timer features (see chapter SELECTING TIMER FEATURES).

After a few minutes of inactivity, the appliance goes into Standby mode.

CHANGING CLOCK SETTINGS

You can change the time of day when no timer function is activated (see chapter SELECTING GENERAL SETTINGS).

SELECTING THE MAIN MENUS FOR BAKING AND SETTINGS

You can control baking in several different ways:

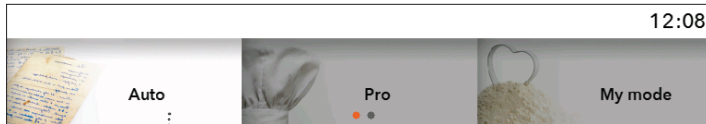

Turn the KNOB and select the name of the menu. Confirm the selection by pressing the KNOB. The NAME of the selected menu appears above.



Confirm each setting by pressing the KNOB.

A) Auto

In this mode, first select the type of dish and then the selected food with automatic setting of the quantity, level of doneness and end of operation.

The programme offers a variety of pre-set recipes, tested by chefs and nutrition experts.

B) Pro

This mode offers a selection of dishes with factory pre-set values, which you can modify.

C) My mode

This mode allows you to prepare dishes according to your wishes, each time using the same steps and settings. You can save your settings in the oven's memory and recall them the next time you want to use them.

A) BAKING BY SELECTING THE TYPE OF FOOD (Automatic mode Auto)

 Confirm each setting by pressing the KNOB.

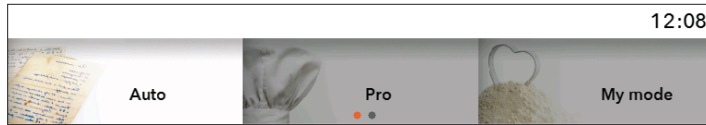

Turn the KNOB and select the **Auto**. Confirm your selection by pressing the KNOB.

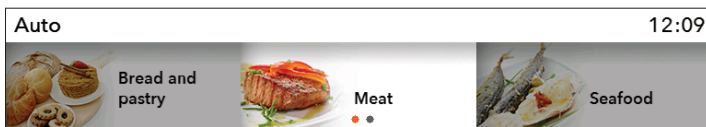

Select the type of dish and the selected food. Confirm your selection.

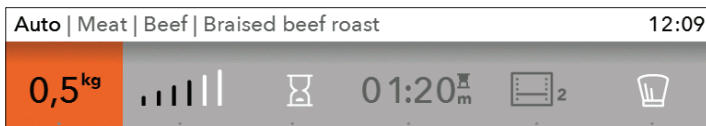

The pre-set values are shown. You can change the quantity, level of doneness and delayed start (end of baking).

- 1 quantity
- 2 level of doneness
- 3 delayed start
- 4 duration of baking
- 5 baking system and recommended level
- 6 professional (Pro) mode

 If in the **Automatic** mode the symbol  is selected, the programme switches to **Professional (Pro) mode** (see chapter BAKING BY SELECTING THE MODE).

Touch the **START/STOP** key to start the baking process. The display shows all the selected settings.

PREHEATING

Cooking procedures for some dishes in the **Auto** mode also include the preheat function . When you select the food, the following notification will appear: **"Selected program includes preheat function."** (Confirm your selection with the KNOB.) **"Preheating started."** Do not insert the food yet. Actual and set temperature will alternate on the display.

When the selected temperature is reached, the preheating process stops and an acoustic signal is emitted. The following notification will appear on the display: **"Preheating complete."** Open the door and insert the food. The program then resumes the cooking process with selected settings.



When the preheat function is set, delayed start function cannot be used.

B) BAKING BY SELECTING THE MODE OF OPERATION (Professional (Pro) mode)

 Confirm each setting by pressing the KNOB.

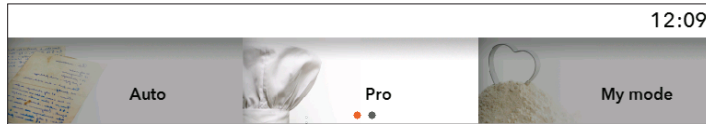

Turn the KNOB and select **Pro**. Confirm your selection.

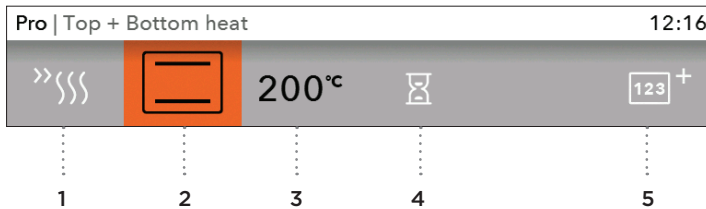

Select your own **basic settings**.

BASIC SETTINGS

- 1 pre-heating
- 2 system (see table OVEN SYSTEMS)
- 3 temperature in the oven

ADDITIONAL SETTINGS

- 4 duration of baking (see chapter TIMER FUNCTIONS – DURATION)
- 5 Multiphase cooking (see chapter Multiphase cooking)

PREHEATING









Use the preheat function if you wish to heat the oven to the desired temperature as quickly as possible. When this symbol  is selected, the preheat function will be activated and a notification will appear: **"Preheating started."** Do not insert the food yet. Actual and set temperature will alternate on the display.



When the selected temperature is reached, the preheating process stops and an acoustic signal is emitted.

The following notification will appear on the display: **"Preheating complete."** Open the door and insert the food. The program then resumes the cooking process with selected settings.

 When the preheat function is set, delayed start function cannot be used.

OVEN SYSTEMS (depending on the model)

SYSTEM	DESCRIPTION	PRESET TEMPERATURE (°C)	MIN - MAX TEMPERATURE (°C)
OVEN SYSTEMS			
	TOP + BOTTOM HEAT The heaters in the bottom and in the ceiling of the oven cavity will radiate heat evenly into the oven interior. Pastry or meat can only be baked/roasted at a single height level.	200	30 - 275
	TOP HEAT Only the heater on the oven cavity ceiling will radiate heat. Use this heater to brown the upper side of the dish.	150	30 - 235
	BOTTOM HEAT Only the heater on the bottom of the oven cavity will radiate heat. Use this heater to brown the lower side of the dish.	160	30 - 235
	SMALL GRILL Only grill heater, a part of the large grill set, will operate. Use this heater to grill a few open sandwiches or beer sausages, or for toasting bread.	240	30 - 275
	LARGE GRILL The upper heater and the grill heater will operate. The heat is radiated directly by the grill heater installed in the oven ceiling. To boost the heating effect, the upper heater is activated as well. This system is used for grilling a smaller amount of open sandwiches or beer sausages, and for toasting bread.	240	30 - 275
	LARGE GRILL + FAN Grill heater and the fan will operate. This combination is used to grill meat and to roast larger chunks of meat or poultry at a single height level. It is also appropriate for dishes au gratin and for browning to a crispy crust.	170	30 - 275
	HOT AIR + BOTTOM HEAT Bottom heater, round heater, and the fan will operate. This is used to bake pizza, moist pastry, fruitcakes, leavened dough and shortcrust on several levels simultaneously.	200	30 - 275
	HOT AIR Round heater and the fan will operate. The fan installed in the back wall of the oven cavity makes sure the hot air constantly circulates around the roast or pastry. This mode is used for roasting meat and baking pastry at several levels simultaneously.	180	30 - 275
	ECO HOT AIR ¹⁾ In this mode, power consumption during the cooking process is optimized. This mode is used for roasting meat and baking pastry.	180	120 - 275

SYSTEM	DESCRIPTION	PRESET TEMPERATURE (°C)	MIN - MAX TEMPERATURE (°C)
OVEN SYSTEMS			
	BOTTOM HEAT + FAN This is used for baking leavened but low-rising pastry and for preserving fruit and vegetables.	180	30 - 230
	ROASTING In the Auto Roast mode/system, the upper heater will operate in combination with the grill heater and the round heater. It is used for roasting all types of meat.	180	30 - 240

¹⁾ It is used for determining the energy efficiency class pursuant to the EN 60350-1 standard.

In this mode, the actual temperature in the oven is not displayed due to a special appliance operation algorithm and use of residual heat.

Touch the **START/STOP** key to start the baking process.
The display shows all the selected settings.

 The symbol °C flashes on the display until the set temperature is reached. A sound signal beeps. During the process you cannot change the baking systems.

TIMER FUNCTIONS - DURATION



In the basic Professional mode you can select the **Timer function**. Confirm your selection by pressing the KNOB.

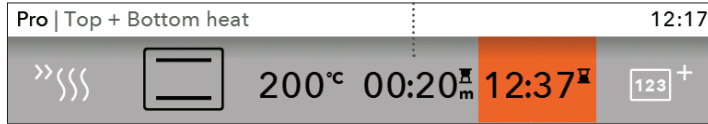

Duration of oven operation

Delayed start



Setting the cooking time

In this mode, you can define the duration of oven operation. Set the desired cooking time and confirm the selection (max. cooking time is 10 hours). The displayed end time is adjusted accordingly. Press START to start the cooking process. The display shows all the selected settings. Turn off all timer functions by setting the selected time to 0.



Setting the delayed start

 Delayed switch-on is not possible on the systems small grill, large grill, and grill with fan.

In this mode, you may specify the duration of the cooking process (cooking time) and the time when you wish the cooking process to stop (end time) (the delay can be set for 24 hours). Make sure the clock is accurately set to current time.

Example:

Current time: 12:00

Cooking time: 2 hours

End of cooking: 18:00

First, set the COOKING TIME (2 hours). The sum of the current time and cooking time is automatically displayed (14:00). Then select END TIME and set the timer (18:00).

Press START to start the cooking process. The timer will wait for the time to start the cooking process. The display shows the message: **"Start delayed. Cooking will start at 16:00."**

When the set time expires, the oven will automatically stop operating.



When the set time expires, the oven will automatically stop operating (end of cooking). A short acoustic signal will be emitted and the Finish menu will appear.

After a few minutes of inactivity, the appliance goes into Standby mode.

MULTIPHASE COOKING

This mode allows you to combine three consequent different manners of food preparation in one baking.

By selecting different settings you can prepare dishes exactly as you wish.



In the basic Professional (Pro) mode you can select the **Multiphase cooking**. Confirm your selection by pressing the KNOB.



Select: step 1, step 2, step 3
Confirm your settings by pressing the KNOB.

 Step 1 is already selected if you have set the **Timer functions** beforehand.

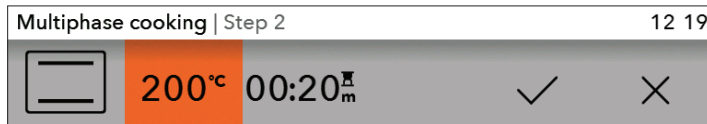

Set the system, temperature and time. Confirm your selection with a CHECK MARK by pressing the KNOB.





Entire baking time - end

Progress of the current step

Temperature and duration of the selected step

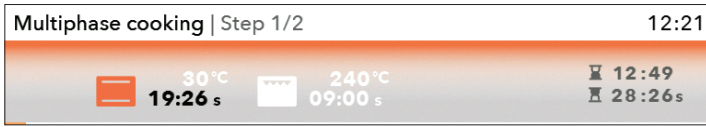
By touching the START key, the oven first starts operating according to step 1. (The progress bar on the bottom of the display indicates the current step of the baking process). When a certain time expires, step 2 is activated and then step 3 if it was selected.



 If you want to cancel any of the steps during the operation, turn the KNOB, select the step and cancel it by confirming with a CROSS MARK. You can only do this with the steps that haven't been initiated yet.

C) STORING YOUR OWN PROGRAMME (MY MODE)

When the cooking process is complete, the "Finish" menu will appear. Select the  symbol to store your settings into the oven memory.



Select the field with asterisks for which you will select a new recipe name.

 You can store up to 12 recipes in the memory.

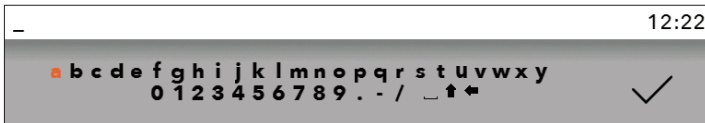

Rotate the KNOB and confirm respective characters to enter the name. If required, delete a character with the arrow; store the name with the check mark.

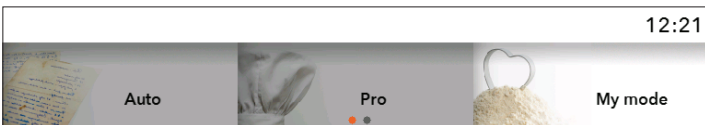

You can retrieve your favourite recipes by choosing My mode in the main menu. Confirm your selection with the KNOB.

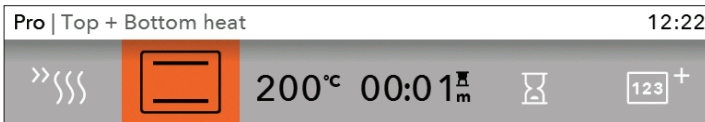

The pre-set values are shown and you can change them if necessary.

When the program is complete, the **Finish** menu will appear. If you have made any changes, you can store them by selecting the  symbol. Select a recipe with the same name. The sign **"The program will be overwritten"** appears on the display.

- Confirm the selection to store the recipe under the same or a new name.
- You may also cancel your selection. A display will appear on which you can select a new field and store the new recipe.

START OF BAKING

Before the beginning of baking, the START/STOP key flashes.

Start the baking process by briefly touching the START/STOP key.

If you want to change the current settings during baking, turn the KNOB and select the setting or value. Confirm your selection.



 If the door is opened during the baking process, baking stops and continues once the door is closed again. This must be done within 3 minutes, otherwise the baking process is terminated and the word **Finish** is displayed on the screen.

END OF BAKING AND OVEN SHUT-OFF

You can end the baking process by touching the START/STOP key.

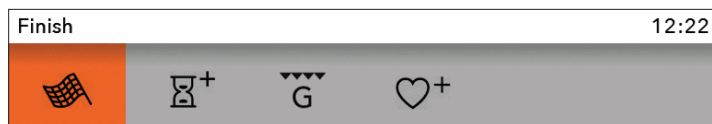

Turn the KNOB and the menu **Finish** appears along with the symbols.



Finish

Select the icon and end the baking process. The display shows the main menu.



Add duration

You can extend the duration of baking by selecting the icon. You can determine a new time of the end of baking (see chapter **TIMER FUNCTIONS - DURATION**).



Au gratin

Choose this symbol to brown the upper layer of the dish after cooking.



Add to favourites

You can store the selected settings in the oven memory and use them again the next time.

 After the use of the oven, some water may be left in the condensate channel (underneath the door). Wipe the channel with a sponge or a cloth.

SELECTING ADDITIONAL FEATURES

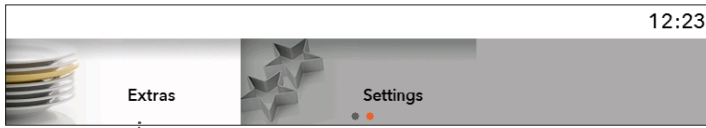

Turn the KNOB and select **Extras** in the main menu. Confirm your selection. The additional functions menu is displayed.



Some functions are not available with some systems; an acoustic signal sounds in such cases.

Cleaning /Aqua clean

This program makes it easier to remove any stains from inside the oven. (See chapter CLEANING AND MAINTENANCE.)

Defrost

In this mode, the air circulates without any heaters operating. Only the fan is operating.

It is used for slow defrosting of frozen food (cakes, pastry, bread and rolls, and deep-frozen fruit).

By selecting the symbol, set the type of food, weight, and the time of start and end of defrosting process.

Halfway through the defrost time, the pieces should be turned over, stirred and separated if they were frozen together.

Warming

Use this function to keep the prepared dishes at the desired temperature.

By selecting the symbol, you can set the temperature and the time of start and end of the warming process.

Plate warmer

Use this function to pre-heat your dinnerware (plates, cups) before serving food in it to keep the food warm longer. By selecting the symbol, you can set the temperature and the time of start and end of the heating process.

Rapid pre-heat

Use this function if you wish to heat the oven to the desired temperature as quickly as possible. Not appropriate for cooking food. When the oven heats up to the set temperature, the heating process is completed and the oven is ready for operation in the selected programme.

Shabbat

In this mode, set the temperature between 85 and 180 °C and the time (up to 74 hours) of Sabbath duration. Press START to start the countdown. A light will be lit in the oven. All sounds and operation, except for the ON/OFF key, will be deactivated. When the process is complete, the settings can be stored.

 In the case of power outage, Shabbat mode is cancelled and oven goes back in the start position.



Warning: producer is not responsible for improper use of Shabbat mode.

Finish

07:39



Turn the KNOB to display the **Finish** menu with a display of symbols.

SELECTING GENERAL SETTINGS



Turn the KNOB and select **Settings** in the main menu. Confirm your selection.

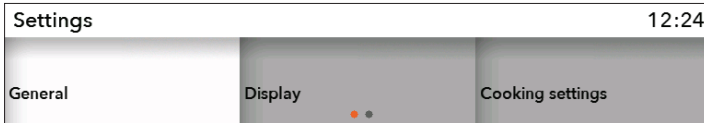

By turning the KNOB you can move around the menu. Confirm each selection by pressing the KNOB.

General

Language - select the language in which you want the text to be displayed.

Time - time of day must be set when you connect the appliance to the power mains for the first time or if the appliance has been disconnected from the power mains for a longer period of time (more than one week). Set the CLOCK - time. In the Time field you can also select digital or analogue clock display.

Date - set the date when connecting the appliance to the power mains for the first time or if the appliance has been disconnected from the power mains for a longer period of time (more than one week). Set the day, month and year.

Sound - the volume of the sound signal can be set only when no time feature is activated (only the time of day is shown).

Volume - you can choose three different levels of volume.

Sound of key - you can activate or deactivate it.

Sound on start/stop - you can activate or deactivate it.

Display

In this menu you can set:

Brightness - you can set three different levels.

Night mode - set the timeframe when you want the display to be dimmed.

Appliance to stand-by mode - the display automatically switches off after 1 hour.

Cooking settings

Power of baking in the default programme.

System

Appliance information

Factory settings

Oven light during operation - illumination is turned off when you open the door during the baking process.

Oven illumination - oven illumination is activated automatically when you open the door or turn on the oven. When the baking process is finished, the light stays on for about 1 minute. You can turn the light on or off by pressing the light activated.



CHILD LOCK

It is activated by touching the CHILD LOCK key. The message **"Child lock activated"** is displayed. Touch the key again to deactivate the child lock.



If the child lock is activated with no timer function engaged (only clock is displayed), the oven will not operate. If the child lock is activated after a timer function has been set, the oven will operate normally; however, it will not be possible to change the settings. When the child lock is activated, systems or additional functions cannot be changed. The only possible change is to end the cooking process. Child lock will remain active after the oven is switched off. To select a new system, the child lock must first be deactivated.



SETTING THE MINUTE MINDER

The minute minder can be used separately, independently of the oven operation. It is activated by pressing the key. The maximum setting is 10 hours. When the set time expires, an acoustic signal sounds, which can be turned off by pressing any key or is turned off automatically after one minute.



After a power outage or after the appliance is switched off, all additional settings will remain stored.

DESCRIPTIONS OF SYSTEMS (COOKING MODES) AND COOKING TABLES

If your desired food cannot be found in the cooking table, find information for similar food.

The information displayed applies to cooking in a single level.

An interval of suggested temperature is indicated. Start with a lower temperature setting and increase it if you find the food is not browned sufficiently.

Cooking times are rough estimates and may vary subject to some conditions.

Only preheat the oven if required by the recipe or in the tables in this instruction manual. Heating an empty oven consumes a lot of energy. Hence, baking several types of pastry or several pizzas successively will save a lot of energy as the oven will already have been preheated.

When using parchment paper, make sure it is resistant to high temperatures.

When cooking larger chunks of meat or pastry, a lot of steam will be generated inside the oven, which in turn may condense on the oven door. This is a normal phenomenon which will not affect the operation of the appliance. After the cooking process, wipe the door and the door glass dry.

Switch off the oven approximately 10 minutes before the end of the cooking process to save energy by making use of the accumulated heat.

Do not cool the food in a closed oven to prevent condensation (dew).



The symbol * means that the oven should be preheated using the selected cooking system.

TOP + BOTTOM HEAT

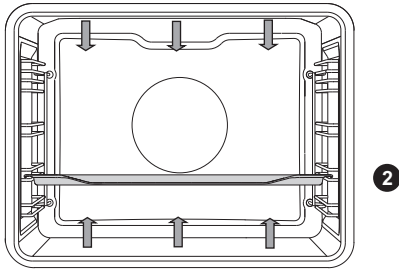

The heaters in the bottom and in the ceiling of the oven cavity will radiate heat evenly into the oven interior.

Roasting meat

Use enamel coated, tempered glass, clay, or cast iron pans or trays. Stainless steel trays are not suitable as they strongly reflect the heat. During roasting, provide enough moisture to keep the meat from burning. Turn the meat during roasting. If you cover the roast, it will remain juicier.

Type of food	Weight (g)	Guide (from the bottom)	Temperature (°C)	Cooking time (min)
MEAT				
Pork roast	1500	2	180 - 200	90 - 120
Pork shoulder	1500	2	180 - 200	110 - 140
Pork roulade	1500	2	180 - 200	90 - 110
Roast beef	1500	2	170 - 190	120 - 150
Veal roulade	1500	2	180 - 200	80 - 100
Lamb sirloin	1500	2	180 - 200	60 - 80
Rabbit loin	1000	2	180 - 200	50 - 70
Deer shank	1500	2	180 - 200	90 - 120
FISH				
Braised fish, 1 kg	1000g/piece	2	190 - 210	40 - 50

Baking pastry

Only use one level and dark baking sheets or trays. In light-coloured baking sheets or trays, the browning of the pastry will be poorer, as such equipment will reflect the heat. Always place the baking trays on the grid. If you are using the supplied baking sheet, remove the grid. Cooking time will be shorter if the oven is preheated.

Type of food	Guide (from the bottom)	Temperature (°C)	Cooking time (min)
PASTRY			
Vegetable soufflé	2	190 – 210	35 – 45
Sweet soufflé	2	170 – 190	40 – 50
Bread rolls *	3	190 – 210	20 – 30
White bread, 1 kg *	3	220	10 – 15
		180 – 190	30 – 40
Buckwheat bread, 1 kg *	3	180 – 190	50 – 60
Whole grain bread, 1 kg *	3	180 – 190	50 – 60
Rye bread, 1 kg *	3	180 – 190	50 – 60
Spelt bread, 1 kg *	3	180 – 190	50 – 60
Walnut cake	2	170 – 180	50 – 60
Sponge cake *	2	160 – 170	30 – 40
Small pastries made with yeast dough	3	200 – 210	20 – 30
Cabbage pirozhki *	3	190 – 200	25 – 35
Fruitcake	2	130 – 150	80 – 100
Meringue cookies	3	80 – 90	110 – 130
Jelly-filled rolls (Buchtel)	3	170 – 180	30 – 40

Tip	Use
Is the cake done?	<ul style="list-style-type: none"> • Pierce the cake at the top with a wooden toothpick or skewer. If there are no traces on the pick or the skewer when pulled out, the cake is done.
Did the cake collapse?	<ul style="list-style-type: none"> • Check the recipe. • Next time, use less liquid. • Note the mixing time when using small mixers, blenders etc.
The cake is too light at the bottom?	<ul style="list-style-type: none"> • Use a dark-coloured baking sheet or tray. • Place the baking sheet one guide lower and switch on the lower heater towards the end of the cooking progress.
Cake with moist stuffing is underdone?	<ul style="list-style-type: none"> • Increase temperature and extend baking time.



Do not insert the deep baking tray into the first guide.

LARGE GRILL, SMALL GRILL

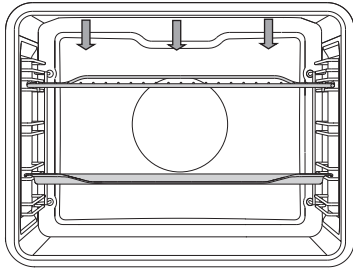

4

2

When grilling food with the large grill, the upper heater and the grill heater fitted on the ceiling of the oven cavity will operate.

When grilling with the small grill, only the grill heater (a part of the large grill set) will operate.

Max allowed temperature : 240°C.

Pre-heat the infra red (grill) heater for five minutes. Supervise the cooking process at all times. The meat may burn quickly due to high temperature!

Roasting with the grill heater is suitable for crispy and low-fat cooking of bratwurst, cuts of meat and fish (steaks, escalopes, salmon steaks etc.) or toasted bread.

When grilling directly on the grid, smear it with oil to prevent the meat from sticking onto it and insert it into the 4th guide. Insert the drip tray into the 1st or 2nd guide.

When grilling in a tray, provide enough moisture to keep the meat from burning. Turn the meat during grilling.

After each grilling, clean the oven and the accessories.

Grilling table - small grill

Type of food	Weight (g)	Guide (from the bottom)	Temperature (°C)	Cooking time (min)
MEAT				
Beefsteak, rare	180 g/piece	4	240	20-25
Pork neck fillet	150 g/piece	4	240	25-30
Cutlets/chops	280 g/piece	4	240	30-35
Grill sausages	70 g/piece	4	240	20-25
TOASTED BREAD				
Toast	/	4	240	5-10
Open sandwiches	/	4	240	5-10

Grilling table - large grill

Type of food	Weight (g)	Guide (from the bottom)	Temperature (°C)	Cooking time (min)
MEAT				
Beefsteak, rare	180 g/piece	4	240	10 - 15
Beefsteak, well done	180 g/piece	4	240	15 - 20
Pork neck fillet	150 g/piece	4	240	15 - 20
Cutlets/chops	280 g/piece	4	240	20 - 25
Veal escalope	140 g/piece	4	240	15 - 20
Grill sausages	70 g/piece	4	240	10 - 20
Spam (Leberkäse)	150 g/piece	4	240	15 - 20
FISH				
Salmon steaks/fillets	200 g/piece	4	240	15 - 20
TOASTED BREAD				
6 slices of bread	/	4	240	1 - 4
Open sandwiches	/	4	240	2 - 5

When grilling in a baking tray, make sure there is enough liquid in the tray to prevent burning. Turn the meat during cooking.

When baking trout, pat the fish dry with a paper towel. Season on the inside; coat with oil on the outside and place on the grid. Do not turn the fish when grilling.



Always keep the oven door closed when using the grill (infrared) heater.

Grill heater, grid, and other oven accessories get very hot during grilling. Therefore, use oven mitts and meat tongs.

LARGE GRILL + FAN

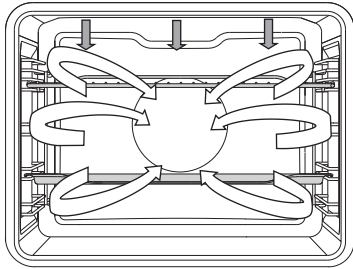

In this operating mode, the grill heater and the fan operate simultaneously. Suitable for grilling meat, fish, and vegetables.

(See descriptions and tips for Large grill and Small grill.)

Type of food	Weight (g)	Guide (from the bottom)	Temperature (°C)	Cooking time (min)
MEAT				
Duck	2000	2	180 - 200	90 - 110
Pork roast	1500	2	170 - 190	90 - 120
Pork shoulder	1500	2	160 - 180	100 - 130
Half of chicken	700	2	190 - 210	50 - 60
Chicken, 1.5 kg	1500	2	200 - 220	60 - 80
Meat loaf	1500	2	160 - 180	70 - 90
FISH				
Trout	200 g/piece	2	200 - 220	20 - 30

HOT AIR + BOTTOM HEAT

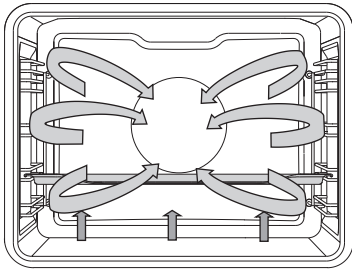

The bottom heater, the round heater, and the hot air fan will operate. Suitable for baking pizzas, apple pies, and fruitcakes.

(See descriptions and tips for UPPER and BOTTOM HEATER.)

Type of food	Guide (from the bottom)	Temperature (°C)	Cooking time (min)
PASTRY			
Cheesecake, short crust	2	150 - 160	60 - 70
Pizza *	3	210 - 220	10 - 15
Quiche Lorraine, shortcrust	2	190 - 200	50 - 60
Apple strudel, phyllo dough	2	170 - 180	50 - 60

HOT AIR

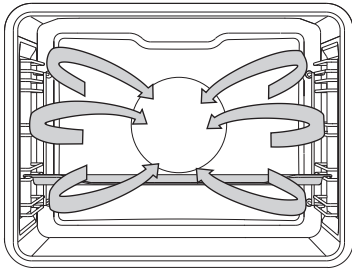

Round heater and the fan will operate. The fan installed in the back wall of the oven cavity makes sure the hot air constantly circulates around the roast or pastry.

Roasting meat:

Use enamel coated, tempered glass, clay, or cast iron pans or trays.
Stainless steel trays are not suitable as they strongly reflect the heat.

During roasting, provide enough moisture to keep the meat from burning. Turn the meat during roasting. If you cover the roast, it will remain juicier.

Type of food	Weight (g)	Guide (from the bottom)	Temperature (°C)	Cooking time (min)
MEAT				
Pork roast, including skin	1500	2	160 - 180	90 - 120
Chicken, whole	1500	2	170 - 190	70 - 90
Duck	2000	2	160 - 180	120 - 150
Goose	4000	2	150 - 170	170 - 200
Turkey	5000	2	150 - 170	180 - 210
Chicken breast	1000	3	180 - 200	50 - 60
Stuffed chicken	1500	2	180 - 200	110 - 130

Baking pastry

Pre-heating of the oven is recommended.

Small pastries can be baked in low trays in several levels (2nd and 3rd).

Keep in mind that with different baking trays, the baking time may vary.

You may have to remove the upper tray sooner than the lower one.

Always place the baking pans on the grid; if you are using the supplied baking tray, remove the grid.

Small pastries should be of the same thickness in order to achieve even browning.

Type of food	Guide (from the bottom)	Temperature (°C)	Cooking time (min)
PASTRY			
Sponge cake	2	150 - 160	30 - 40
Crumble cake	3	160 - 170	25 - 35
Plum cake	2	150 - 160	30 - 40
Sponge roll *	3	160 - 170	15 - 25
Fruit cake, short crust	2	160 - 170	50 - 70
Challah (braided yeast bun)	2	160 - 170	35 - 50
Apple strudel	3	170 - 180	50 - 60
Pizza *	3	200 - 210	15 - 20
Biscuits, short crust *	3	150 - 160	15 - 25
Biscuits, pressed *	3	140 - 150	20 - 30
Small cakes *	3	140 - 150	20 - 30
Cookies, leavened	3	170 - 180	20 - 35
Cookies, phyllo dough	3	170 - 180	20 - 30
Cream-filled pastry	3	180 - 190	25 - 45
FROZEN PRODUCTS			
Apple and cottage cheese strudel	3	170 - 180	55 - 70
Pizza	3	180 - 190	20 - 35
Fried potatoes, oven-ready	3	200 - 210	25 - 40
Croquettes, oven-baked	3	200 - 210	20 - 35



Do not insert the deep baking tray into the first guide.

ECO HOT AIR

eco

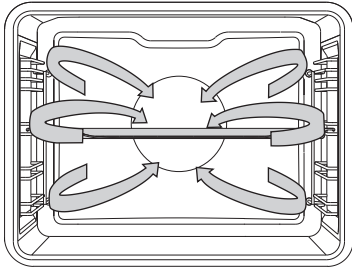

Round heater and the fan will operate. The fan installed on the back wall of the oven cavity makes sure the hot air constantly circulates around the meat, vegetables, or pastry.

Type of food	Guide (from the bottom)	Temperature (°C)	Cooking time (min)
MEAT			
Pork roast, 1 kg	2	190 - 200	110 - 130
Pork roast, 2 kg	2	190 - 200	130 - 150
Beef roast, 1 kg	2	200 - 210	100 - 120
FISH			
Whole fish, 200 g/piece	3	190 - 200	40 - 50
Fish fillet, 100 g/piece	3	200 - 210	25 - 35
PASTRY			
Pressed cookies	3	170 - 180	15 - 25
Small cupcakes	3	180 - 190	30 - 35
Sponge roll	3	190 - 200	15 - 25
Fruit cake, short crust	2	180 - 190	55 - 65
DISHES AU GRATIN			
Potatoes au gratin	2	180 - 190	40 - 50
Lasagne	2	190 - 200	45 - 55
FROZEN PRODUCTS			
Pommes frites, 1 kg	3	220 - 230	35 - 45
Chicken medallions, 0.7 kg	3	210 - 220	30 - 40
Fish sticks, 0.6 kg	3	210 - 220	30 - 40



Do not insert the deep baking tray into the first guide.

BOTTOM HEAT + FAN

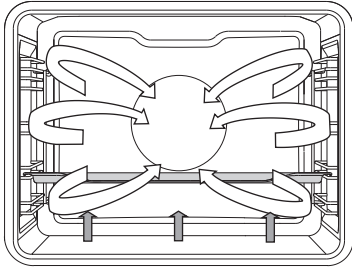

This is used for baking leavened but low-rising pastry and for preserving fruit and vegetables. Use the second guide from the bottom and a rather shallow baking tray to allow the hot air to circulate across the upper side of the dish.

PRESERVATION

Prepare the food to be preserved and jars as usual. Use jars with a rubber sealing ring and a glass cover. Do not use jars with threaded or metal caps or metal tins. Make sure the jars are of equal size, filled with the same contents, and tightly sealed.

Pour 1 litre of hot water into the deep tray (approx. 70°C) and place 6 1-litre jars into the tray. Place the tray into the oven on the second guide.

During preservation, observe the food and cook until the liquid in the jars starts to simmer - when bubbles appear in the first jar.

Type of food	Guide (from the bottom)	Temperature (°C)	Cooking time (min)	Temperature at the start of simmering	Resting time in the oven (min)
FRUIT					
Strawberries (6×1 l)	2	180	40 - 60	switch off	20 - 30
Stone fruits (6×1 l)	2	180	40 - 60	switch off	20 - 30
Fruit mush (6×1 l)	2	180	40 - 60	switch off	20 - 30
VEGETABLE					
Pickled gherkins (6×1 l)	2	180	40 - 60	switch off	20 - 30
Beans/carrots (6×1 l)	2	180	40 - 60	120 °C, 60 min	20 - 30

ROASTING

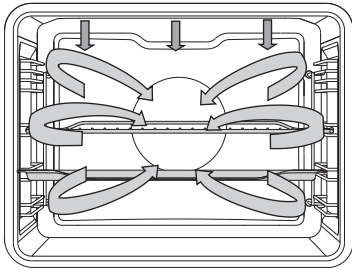

In the Auto Roast mode, the upper heater will operate in combination with the grill heater and the round heater. It is used for roasting all types of meat.

When roasting directly on the grid, smear it with oil to prevent the meat from sticking onto it and insert it into the 3rd guide. Insert the drip tray into the 2nd or 3rd. When roasting meat in the tray, insert the tray into the 2nd guide. Set the cooking system and temperature, and the final temperature of the dish.

Type of food	Weight (g)	Guide (from the bottom)	Temperature (°C)	Cooking time (min)	Core temperatur (°C)
MEAT					
Beef tenderloin	1000	2	160 - 180	60 - 80	55 - 75*
Chicken, whole	1500	2	170 - 190	65 - 85	85 - 90
Turkey	4000	2	160 - 180	150 - 180	85 - 90
Pork roast	1500	2	160 - 180	100 - 120	70 - 85
Meat loaf	1000	2	160 - 180	50 - 65	80 - 85
Veal	1000	2	160 - 180	70 - 90	75 - 85
Lamb	1000	2	170 - 190	50 - 70	75 - 85
Venison	1000	2	170 - 190	60 - 90	75 - 85
Whole fish	1000	3	160 - 180	40 - 50	75 - 85

* rare = 55-60 °C; medium = 65-70 °C; well done = 70-75 °C

Roasting with a meat probe (depending on the model)

In this mode, set the desired temperature of the food core. The oven operates until the food core reaches the set temperature. Temperature core is measured by the temperature probe.

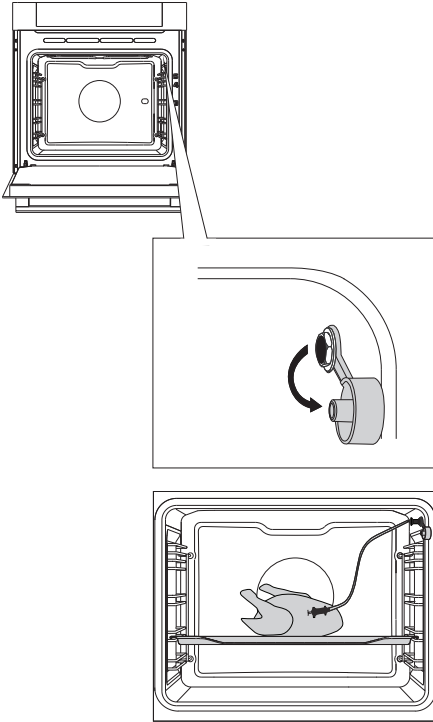

1 Remove the metal cap (the socket is in the front upper corner of the oven right wall).

2 Connect the meat probe plug to the socket and stick the probe into the food. (If any timer settings were activated, they will be cancelled.)

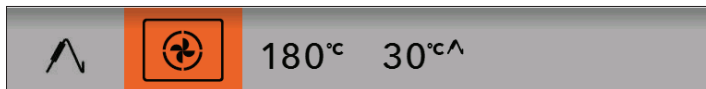

Select the system (example: hot air).

Preset temperature and probe temperature will be displayed. Set the cooking system and temperature, and the final temperature of the dish. Touch the START key.

 During cooking, the rising temperature of the core will be displayed (the desired core temperature may be adjusted during the cooking process).

When the set core temperature is reached, the cooking process will stop.

An acoustic signal will be heard which you may turn off by touching any key. After one minute, the acoustic signal will be switched off automatically. Clock will appear on the display.

After the cooking process, replace the metal cap of the meat probe socket.

Degrees of doneness for meat

TYPE OF MEAT	Core temperature (°C)
BEEF	
Raw	40 – 45
Rare	55 – 60
Medium	65 – 70
Well done	75 – 80
VEAL	
Well done	75 – 85
PORK	
Medium	65 – 70
Well done	75 – 85
LAMB	
Well done	79
MUTTON	
Raw	45
Rare	55 – 60
Medium	65 – 70
Well done	80
GOAT MEAT	
Medium	70
Well done	82
POULTRY	
Well done	82
FISH	
Well done	65 – 70



Only use the probe intended for use with your oven. Make sure the probe does not touch the heater during cooking. After the cooking process, the probe will be very hot. Take care to prevent burning.

MAINTENANCE & CLEANING



Before you start cleaning the appliance, disconnect it from the power mains and let it cool down.

Cleaning and maintenance of the appliance should not be performed by children without appropriate supervision!

Aluminium surfaces

Aluminium surfaces should be cleaned with non-abrasive liquid detergents intended for such materials.

Apply the detergent on a wet cloth, clean the surface and rinse with water.

Do not apply the cleaner directly on the surface.

Do not use abrasive cleaners or abrasive sponges.

Note: The surface should not come into contact with oven cleaning sprays; this may cause visible and permanent damage.

Stainless steel front panels

(depending on the model)

Clean the surface with a mild cleaner (soapsuds) and a soft non-abrasive sponge.

To avoid damages to the surface, do not use abrasive or solvent-based cleaners.

Lacquer-coated and plastic surfaces

(depending on the model)

Never use abrasive cleaners and sponges, alcohol-based cleaners or pure alcohol to clean the knobs, door handles, labels and the rating plate.

Remove the stains immediately using a soft cloth and liquid detergents. You may also use the cleaners made especially for this type of surfaces; in this case, follow the manufacturer's instructions.



The aluminium surfaces should never come into contact with oven cleaning sprays, as these will cause visible and permanent damage.

CONVENTIONAL OVEN CLEANING

You may use the standard cleaning procedure to clean stubborn dirt in the oven (using cleaners or an oven spray). After such cleaning, rinse the cleaner residues thoroughly.

Clean the oven and the accessories after each use to prevent the dirt from burning into the surface. The easiest way to remove grease is by using warm soapsuds while the oven is still warm.

With stubborn dirt and grime, use conventional oven cleaners. Rinse the oven thoroughly with clean water to remove all cleaner residue. Never use aggressive cleaners, abrasive cleaners, abrasive sponges, stain and rust removers etc.

Clean the accessories (baking sheets and trays, grids etc.) with hot water and detergent.

The oven, the oven cavity and the baking trays are lined with a special enamel coating for a smooth and resistant surface. This special coating makes cleaning at room temperature easier.

AQUA CLEAN CLEANING PROGRAM

Before running the cleaning program, remove all large chunks of dirt and food residues from the oven cavity.

Pour 0.6 l of warm water into the deep baking tray and place it in the second guide. Select the oven cleaning program.

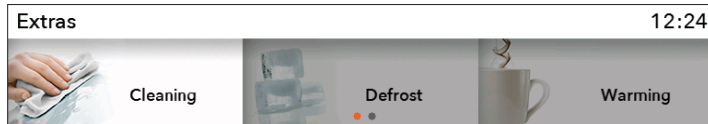

In the main menu, select **Extra** and **Cleaning**. Confirm your selection by pressing the KNOB.

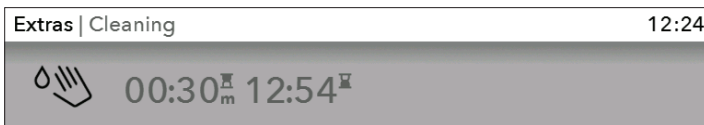

Press the START key.

 When the program is complete, wait for the oven to cool down sufficiently so that you can wipe the oven interior safely.

After the 30-minute program, the stains on the oven enamel walls will soften, which allows easier cleaning. Wipe the stains with a damp cloth.

 If the cleaning process is not successful (in case of particularly stubborn dirt), repeat it.



Use the cleaning program after the oven has fully cooled down.

REMOVING AND CLEANING WIRE AND TELESCOPIC EXTENDIBLE GUIDES

Only use conventional cleaners to clean the guides.

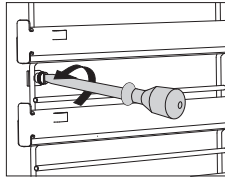
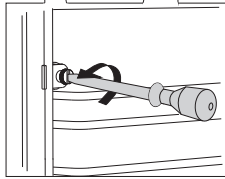
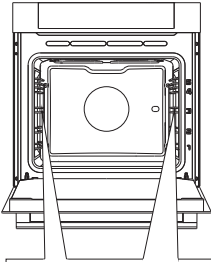

1 Undo the screw.

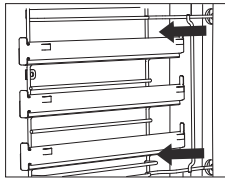
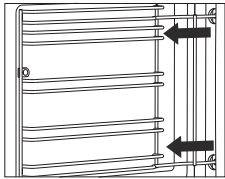

2 Remove the guides from the holes in the back wall.



After cleaning, re-tighten the screws on the guides with a screwdriver.

REMOVING AND INSERTING THE OVEN DOOR

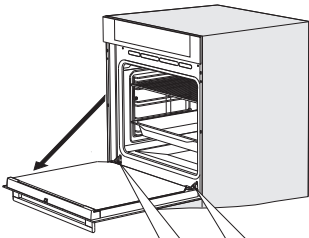

1 First, fully open the door (as far as it will go).

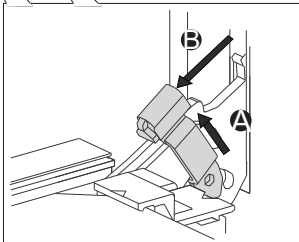

2 Slightly lift the two retainers and pull towards you.

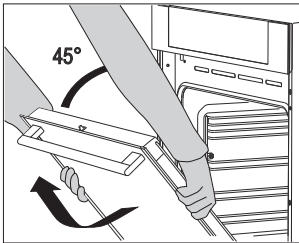

3 Slowly close the door to a 45-degree angle (relative to the position of the fully closed door); then, lift the door and pull it out.

 To replace the door, observe the reverse order. If the door does not open or close properly, make sure the notches on the hinges are aligned with the hinge beds.



When replacing the door, always make sure the hinge retainers are correctly placed in the hinge beds to prevent sudden closing of the main hinge which is connected to a strong main spring. If the main spring is engaged, there is a risk of injury.

DOOR LOCK (depending on the model)

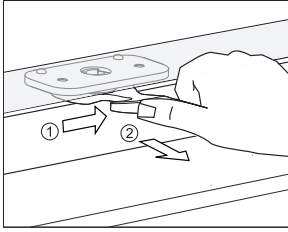

To open it, gently push it to the right with your thumb and pull the door outwards at the same time.

 **When the oven door is closed, the door lock automatically returns to the initial position.**

DEACTIVATING AND ACTIVATING THE DOOR LOCK

 **The oven should be cooled down completely.**

First, open the oven door.

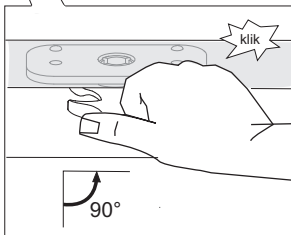
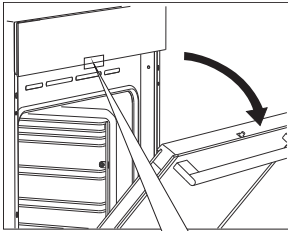

Push the door lock to the right by 90° with your thumb until you feel a click. The door lock is not deactivated.

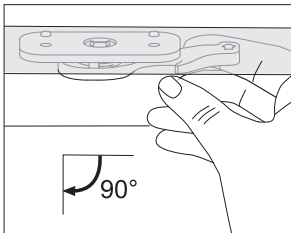

To reactivate the door lock, open the oven door and use your right-hand index finger to pull the lever towards you.

SOFT DOOR OPENING (depending on the model)

Oven door is fitted with a system that dampens the door opening force, starting at the 75-degree angle.

SOFT DOOR CLOSING (depending on the model)

Oven door is fitted with a system that dampens the door closing force, starting at the 75-degree angle. It allows simple, quiet, and smooth closing of the door. A gentle push (to a 15-degree angle relative to the closed door position) is enough for the door to close automatically and softly.



If the force applied to close the door is too strong, the effect of the system is reduced or the system will be bypassed for safety.

REMOVING AND INSERTING THE OVEN DOOR GLASS PANE

Oven door glass pane can be cleaned from the inside, but the door must be removed first. Remove the oven door (see chapter REMOVING AND REPLACING THE OVEN DOOR).

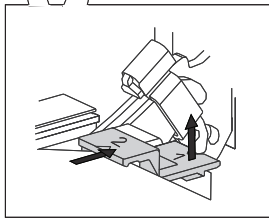
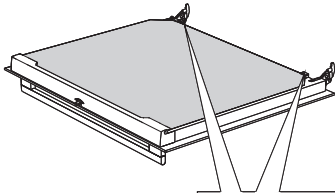

1 Slightly lift the supports on the left and right side of the door (marking 1 on the support) and pull them away from the glass pane (marking 2 on the support).

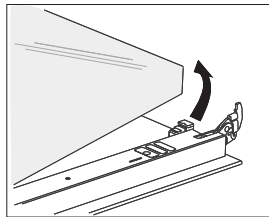

2 Hold the door glass pane by the lower edge; slightly lift it so that it is no longer attached to the support; and remove it.

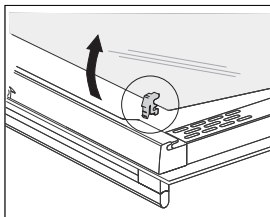

3 To remove the third glass pane (only with some models), lift and remove it. The rubber seals on the glass pane must also be removed.

 To replace the glass pane, observe the reverse order. The markings (semicircle) on the door and the glass pane should overlap.

REPLACING THE BULB

The bulb is a consumable and therefore not covered by warranty. Before changing the bulb, remove the trays, the grid, and the guides.

Use a Phillips (cross) screwdriver.
(Halogen lamp: G9, 230 V, 25 W)

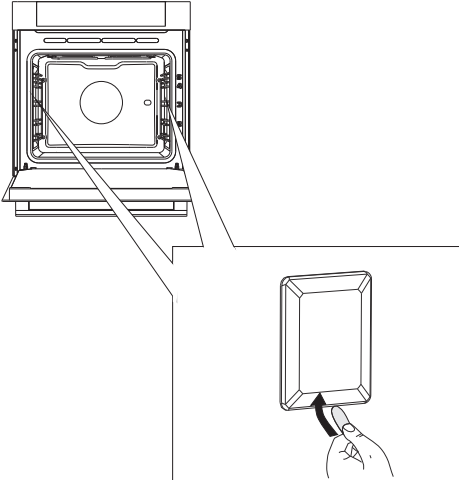

- 1** Use a flat screwdriver to release the bulb cover and remove it.

NOTE: Make sure not to damage the enamel.

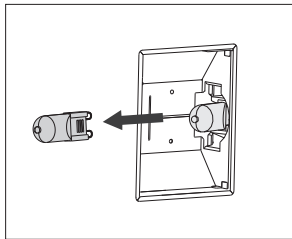

- 2** Remove the halogen bulb.



Use protection to avoid burns.

TROUBLESHOOTING TABLE

Problem/error	Solution
There is no response of the sensors; the display is frozen.	Disconnect the appliance from the power mains for a few minutes (undo the fuse or switch off the main switch); then, reconnect the appliance and switch it on.
The main fuse in your home trips often.	Call a service technician.
The oven lighting does not work.	The process of changing the light bulb is described in the chapter Cleaning and Maintenance.
The pastry is underdone.	Did you choose the right temperature and heating system? Is the oven door closed?
Error code is displayed: ERRXX ... * XX denotes the number/code of the error.	There is an error in the electronic module operation. Disconnect the appliance from the power mains for a few minutes. Then, reconnect it and set the time of day. If the error is still indicated, call a service technician.

If the problems persist despite observing the advice above, call an authorized service technician. Repair or any warranty claim resulting from incorrect connection or use of the appliance shall not be covered by the warranty. In this case, the user will cover the cost of repair.



Before the repair, disconnect the appliance from the power mains (by removing the fuse or by removing the plug from the wall outlet).

DISPOSAL



Packaging is made of environmentally friendly materials that can be recycled, disposed of, or destroyed without any hazard to the environment. To this end, packaging materials are labelled appropriately.

The symbol on the product or its packaging indicates that the product should not be treated as normal household waste. The product should be taken to an authorized collection center for waste electric and electronic equipment processing.

Correct disposal of the product will help prevent any negative effects on the environment and health of people which could occur in case of incorrect product removal. For detailed information on removal and processing of the product, please contact the relevant municipal body in charge of waste management, your waste disposal service, or the store where you bought the product.

We reserve the right to any changes and errors in the instructions for use.

gorenje⁺



727912