



**Aerogor ALL-IN-ONE Inverter 10 AS**  
**Aerogor ECO Inverter 10 AS/13 AS**  
**Aerogor POWER EVI Inverter 15 AS/18 AS**

## **INSTALLATION MANUAL**



## TABLE OF CONTENTS

---

1	BEFORE USE .....	1
1.1	WARNINGS .....	1
1.2	DISPOSAL .....	3
1.3	HEATING SYSTEM REQUIREMENTS (MANDATORY) .....	3
1.4	EMERGENCY SWITCH .....	3
1.5	INCLUDED IN THE PACKAGE .....	4
1.6	TECHNICAL TABLE.....	5
1.6.1	AEROGOR ALL-IN-ONE INVERTER 10 AS .....	5
1.6.2	AEROGOR ECO INVERTER 10 AS, 13 AS .....	6
1.6.3	AEROGOR POWER EVI INVERTER 15 AS, 18 AS.....	7
1.7	DIMENSIONS .....	8
1.7.1	INDOOR UNITS .....	8
1.7.2	OUTDOOR UNITS .....	9
1.8	OPERATING RANGE .....	10
1.9	WORKING PRINCIPLE .....	11
1.10	MAIN COMPONENTS.....	12
1.10.1	INDOOR UNITS .....	12
1.10.2	OUTDOOR UNITS .....	14
1.10.3	AEROGOR POWER EVI INVERTER 15 AS/ 18 AS.....	15
2	INSTALLATION.....	15
2.1	INSTALLATION OF THE INDOOR UNIT .....	15
2.2	INSTALLATION OF THE OUTDOOR UNIT.....	16
2.3	FOUNDATION .....	18
2.3.1	INSTALLATION OF C PROFILE AND LEGS .....	19
2.4	INSTALATION OF THE REFRIGERANT SYSTEM (SPLIT TYPE).....	20
2.4.1	Height difference between indoor and outdoor unit .....	23
3	WIRING.....	25
3.1	AEROGOR ALL-IN-ONE INVERTER 10 AS, AEROGOR ECO INVERTER 10 AS, 13 AS AND AEROGOR POWER EVI INVERTER 15 AS, 18 AS .....	25
3.1.1	INDOOR UNIT AEROGOR ALL-IN-ONE INVERTER 10AS .....	25
3.1.2	INDOOR UNIT POWER AND ECO INVERTERS AS .....	26
3.1.3	TEMPERATURE SENSORS.....	27
3.1.4	CONNECTION BETWEEN INDOOR AND OUTDOOR UNIT .....	29
4	CONTROL UNIT .....	30

4.1	DESCRIPTION OF SYMBOLS ON THE CONTROL UNIT .....	30
4.2	DESCRIPTION OF THE TEMPERATURES ON THE CONTROL UNIT .....	33
5	QUICK SETTINGS .....	34
5.1	PARALLEL MOVE OF THE HEATING CURVE.....	34
5.1.1	SETTING THE PARALLEL MOVE OF THE HEATING CURVE – HEATING CIRCUIT 1.....	34
5.1.2	SETTING THE PARALLEL MOVE OF THE HEATING CURVE – HEATING CURVE 2.....	35
5.1.3	SETTING THE DHW TEMPERATURE .....	35
5.2	SETTING THE FIXED TEMPERATURE OF HEATING CIRCUIT.....	36
5.2.1	SETTING THE FIXED TEMPERATURE FOR THE FIRST HEATING CIRCUIT 36	
5.2.2	SETTING THE FIXED TEMPERATURE FOR THE SECOND HEATING CIRCUIT .....	36
6	USER INTERFACE .....	37
6.1	ARRANGMENT OF MENUS .....	37
6.2	MENU ACCESS .....	37
6.3	SETTINGS .....	38
6.3.1	Heating/Cooling Circuit 1.....	38
6.3.2	Heating/Cooling circuit 2 .....	42
6.4	DHW SETTINGS.....	44
6.5	DHW STORAGE .....	46
6.5.1	Sanitary Hot Water Storage Function .....	47
6.5.2	Sanitary Hot Water Storage Timer.....	47
6.5.3	Reheating Function .....	47
6.5.4	Reheating Function Timer .....	47
6.5.5	Reheating Set Temp. ....	47
6.5.6	Reheating Restart $\Delta$ T Setting.....	48
6.6	REDUCED SETPOINT.....	48
6.6.1	Reduced Setpoint.....	48
6.6.2	Temp. Drop/Rise .....	48
6.6.3	Timer for Reduced Setpoint Function .....	48
6.6.4	Quiet Operation.....	49
6.6.5	Allowable Temp. Drifting .....	49
6.6.6	Timer for Quiet Operation.....	49
6.7	ANTI – LEGIONELLA.....	49
6.7.1	Anti – Legionella Program .....	50
6.7.2	Day and Time.....	50

6.7.3	Setpoint.....	50
6.7.4	Duration .....	50
6.7.5	Finish Time .....	50
6.8	VACATION MODE .....	50
6.8.1	Vacation Mode .....	51
6.8.2	Sanitary Hot Water Temp. Drop during Vacation Mode .....	51
6.8.3	Heating Water Temp. Drop during Vacation Mode .....	51
6.8.4	Vacation Start Date .....	51
6.8.5	Vacation Finish Date .....	51
6.9	USER MANAGEMENT.....	51
6.9.1	Permission Level.....	51
6.9.2	Heating/Cooling ON/OFF timer .....	51
6.9.3	Language.....	52
6.9.4	Set Date and Time .....	52
6.9.5	Distribution System Setting .....	52
6.9.6	Save Current Settings .....	52
6.9.7	Load Saved Settings .....	53
6.9.8	Switch to Factory Settings.....	53
6.10	MODE SETTINGS.....	53
6.10.1	Sanitary Hot Water .....	53
6.10.2	Heating.....	53
6.10.3	Cooling.....	53
6.10.4	Basic Operation Modes .....	53
6.10.5	Cooling and Heating Switch .....	54
6.10.6	Ambient Temp. To Start Heating .....	54
6.10.7	Ambient Temp. To Start Cooling .....	55
6.11	BACKUP HEATING.....	55
6.11.1	Backup Heating Sources for Heating.....	56
6.11.2	Priority for Backup Heating Sources (HBH) .....	56
6.11.3	Backup Heating Source for Sanitary Hot Water .....	57
6.11.4	Priority for Backup Heating Sources (HWTBH).....	57
6.11.5	Heating Source Start Accumulating Value (HBH) .....	57
6.11.6	Water Temperature Rise Reading Interval (hwtbh).....	57
6.11.7	Emergency Operation .....	57
6.12	WATER PUMP SETTINGS .....	58
6.12.1	Circulation Pump P0 Type.....	58
6.12.2	Speed Setting of Circulation Pump P0 .....	59

6.12.3	Working Mode of Circulation Pump P0	59
6.12.4	Pump Off Interval for P0	59
6.12.5	Pump On Time for P0	59
6.12.6	Buffer Tank	59
6.12.7	P1 For Heating Operation	59
6.12.8	P1 For Cooling Operation	59
6.12.9	P1 with High Temp. Demand (external switch input)	59
6.12.10	P2 for Heating Operation	59
6.12.11	P2 for Cooling Operation	60
6.12.12	P2 with High Temp. Demand	60
6.13	FLOOR CURING	60
6.13.1	Floor Curing	61
6.13.2	Floor Curing Current Stage	61
6.13.3	Floor Curing Current Stage Running Duration	61
6.13.4	Floor Curing Current Stage Set Temperature	61
6.13.5	Floor Curing Current Stage Valid Running Duration	61
6.13.6	Floor Current Total Running Duration	61
6.13.7	Highest Water Temp. in Floor Curing Operation	61
6.14	ELECTRICAL UTILITY LOCK	62
6.14.1	Electrical Utility Lock	62
6.14.2	Operation Signal for Electrical Utility Lock	62
6.14.3	HBH During Electrical Utility Lock	63
6.14.4	P0 during Electrical Utility Lock	63
6.14.5	Heating Eco Operation	63
6.14.6	Ambient Temp. to Start Heating Eco Operation	63
6.15	OTHER OPTIONS	64
6.15.1	Motorized Diverting Valve switching time	64
6.15.2	Power on Time for Motorized Diverting Valve	64
6.15.3	Refrigerant Recycle Function	64
6.15.4	Control Panel Backlight Light	64
6.15.5	Exit System	65
6.15.6	Anti-freezing protection	65
6.15.7	Mode Switch during Defrosting	65
6.15.8	Mode Signal Output (MODE SWITCHING SIGNAL – MS)	65
6.15.9	Mode Signal type (MODE SWITCHING SIGNAL – MS)	65
6.15.10	Fan Speed Limit	65
6.15.11	Defrosting Logic Selection	66

6.15.12	Activate Wi-Fi module or not? .....	66
6.15.13	Accept setting from Wi-Fi module? .....	66
6.15.14	Connection to the server.....	66
6.15.15	Connection to the router .....	66
6.15.16	MAC .....	66
6.15.17	WI-FI module IP address .....	66
6.15.18	SSID .....	66
6.15.19	Password.....	66
6.15.20	Server address .....	66
6.15.21	Service port .....	66
6.16	UNIT REAL-TIME DATA .....	67
7	ERROR CODES.....	67
7.1	ERROR CODES SHOWN ON THE DISPLAY .....	67
7.2	ERROR CODE MENU .....	67
7.2.1	ACCESSING THE ERROR CODE MENU.....	67
7.2.2	INFORMATIONS IN THE ERROR CODE MENU.....	68
7.2.3	INFO PAGE .....	68
7.3	ERROR CODE LIST .....	70
8	CLEANING THE MAGNETIC/DIRT FILTER CALEFFI .....	79
9	WATER PRESSURE IN THE SYSTEM.....	80
10	EMERGENCY SWITCH.....	81
10.1	LOCATION OF THE EMERGENCY SWITCH .....	82
11	WIRING .....	84
11.1	INDOOR UNIT – POWER AND ECO INVERTERS AS .....	84
11.2	INDOOR UNIT – ALL-IN-ONE INVERTER AS .....	85
11.3	INDOOR UNIT TERMINALS – ECO 10 AS & 13 AS, POWER EVI 15 AS & 18 AS.....	87
11.4	OUTDOOR PCB ECO INVERTER .....	88
11.5	DRIVE FOR EEV .....	90
11.6	OUTDOOR UNIT – POWER EVI INVERTER 15 AS, 18 AS.....	91
11.7	OUTDOOR UNIT DRIVE – AEROGOR POWER EVI 15 AS, 18 AS.....	94

# 1 BEFORE USE

---

Thank you for purchasing our product. We ask that you carefully read the manual and to take into account all of the instructions regarding device operation in order to prevent possible damage to the device or personnel. Technical data can be changed without notice because of product upgrades. Please look at the rating label on the device for latest technical specifications.

## 1.1 WARNINGS

Warnings in this manual address most important topics for proper and safe operation of the heat pump, for this reason follow them directly. For further questions contact your installer or technical support from Gorenje d.d. Contact details are on the last page of this document.

---

### **WARNING**

Before first use, read this manual.

---

### **WARNING**

This unit can be used by children aged from 8 years and above and persons with reduced physical, sensory or mental capabilities or lack of experience and knowledge if they have been given supervision or instruction concerning use of the unit in a safe way and understand the hazards involved. Children should not play with the unit. Cleaning and user maintenance shall not be made by children without supervision.

---

### **WARNING**

Installation, dismantlement and maintenance must be carried out by qualified personnel. Any change to structure of the unit is prohibited since they can lead to personal injury or damage to the unit.

---

### **WARNING**

Water or any other kind of fluid should not come in contact with the unit, it may cause electric shock or destruction of the unit.

---

### **WARNING**

If the power cord gets loose or damaged, it must be repaired by qualified personnel.

---



---

 **WARNING**

To avoid electrical shock, make sure to disconnect the power supply 1 minute or more before servicing the electrical parts. Even after 1 minute, measure the voltage at the terminals of main circuit capacitors or electrical parts before touching. Make sure those voltages are lower than the safe value.

---

 **WARNING**

Do not touch the grill of the ventilator while the device is operating.

---

 **WARNING**

Improper installation or attachment of equipment or accessories could result in electric shock, short-circuit, leaks, fire or other damage to the equipment. Be sure only to use accessories made by Gorenje which are specifically designed for use with the equipment and have them installed by a professional.

---

 **WARNING**

Power supply to the device must be grounded.

---

 **WARNING**

For sanitary hot water, please always add a mixture valve before water tap and set it to proper temperature.

---

 **WARNING**

Do not touch the fins of the coil with bare fingers, it might cause injury.

---

 **WARNING**

It is mandatory to use a suitable fuse for the heat pump and make sure the power supply to the unit corresponds to the specifications. Otherwise the unit might be damaged.

---

 **WARNING**

Please discard the batteries as sorted municipal waste at the accessible collection point.

---

 **WARNING**

Installation of a residual current device (RCD) having a rated residual operating current of 300 mA.

---

## 1.2 DISPOSAL

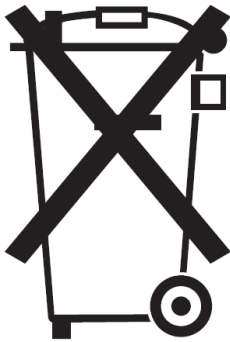

This marking indicates that this product should not be disposed with other household wastes throughout the EU. To prevent possible harm to the environment or human health from uncontrolled waste disposal, recycle it responsibly to promote sustainable reuse of material resources. To return your used device, please use the return and collection systems or contact the retailer where the product was purchased. They can take this product for environmental safe recycling.















## 1.3 HEATING SYSTEM REQUIREMENTS (MANDATORY)

- Installed magnetic filter and dirt separator filter.
- If city water is used for filling of the heating system, the water quality must comply with local regulations.
- Heating system pressure must be between 1 - 1.8 bar.
- Safety valve (3 bar) must be installed in the heating system.
- Expansion vessels must be installed according to heating system.
- Heat pump must be installed into closed loop heating system.
- Installation maintenance must be carried out by qualified personnel.
- If the heat pump is being installed into an existing hydraulic system, the system must be cleaned according to standard procedures.

## 1.4 EMERGENCY SWITCH

Before use, please check that the **EMERGENCY SWITCH** is turned **OFF**. This emergency switch is switched on only if there is major controller malfunction. You can read more about the emergency switch function on **page 80**.

## 1.5 INCLUDED IN THE PACKAGE

NAME	QUANTITY	SYMBOLIC IMAGE
Installation Manual, Warranty cards	1	
Drain pipe	1	
Safety kit	1	
TR – Room temp. sensor + extension cable (10m)	1	
TC – Heat/Cool temp. sensor + extension cable (10m)	1	
TW – DHW temp sensor + extension cable (10m)	1	
TV1 – mixing circuit 1 temp. sensor + extension cable (10m) TV2 – mixing circuit 1 temp. sensor + extension cable (10m)	1	
TA - Ambient temperature sensor	1	
Communication cable (20m)(shielded)	1	
Bracket for indoor unit	1	
Expansion bolts	2	
Connection cable for Tui, Tuo, Tup (20m)(shielded)	/	
Connection cable for the Flow Switch (20m) (shielded)	/	
Wi-Fi set	1	

## 1.6 TECHNICAL TABLE

### 1.6.1 AEROGOR ALL-IN-ONE INVERTER 10 AS

MODEL	ALL-IN-ONE INVERTER 10 AS
ErP Energy efficiency class	A++
SCOP 35°C (floor heating) EN 14825	3,83
P <sub>design</sub> for SCOP EN 14825	6,3 kW
<b>HEATING MODE (A7/W35)</b>	
Heating capacity*	4,57 – 10,67 kW
Rated input power*	0,92 – 3,03 kW
COP - Coefficient of Performance*	5,05
Max. temperature of heating water	55 °C
Operating range of heat pump - Heating (Ambient temp.)	-25 do +45 °C
<b>COOLING MODE (A35/W7)</b>	
Cooling capacity**	2,60 – 8,00 kW
Rated input power**	1,10 – 3,50 kW
EER - Energy Efficiency Ratio**	3,22
Min. temperature of cooling water	7 °C
Operating range of heat pump - Cooling (Ambient temp.)	0 to +65 °C
<b>POWER SUPPLY - SPECIFICATION</b>	
Voltage	220-240 V/50 Hz/1 Ph
Fuse for heat pump	1 X 1p/20A/C
Fuse for electrical flow heater	2 X 1p/16A/C
Fuse for electrical heater in DHW tank	1 X 1p/10A/C
<b>REFRIGERANT SPECIFICATION</b>	
Type of refrigerant	R410A
Refrigerant - mass	1,9 kg
GWP (global warming potential)	2088 GWP
Quantity of hydrofluorocarbons in tonnes of CO <sub>2</sub> equivalent	3,967 t CO <sub>2</sub> Equiv.
Type of compressor	DC inverter (twin rotary)
Hermetically sealed equipment (indoor/outdoor unit)	Yes
Type fo connection between outdoor-indoor unit	Refrigerant connection
Dimensions of refrigerant pipes connectors	3/8" - 1/2"
<b>FAN</b>	
Fan type	1 x Axial
Air flow	3100 m <sup>3</sup> /h
Rated power	60 W
„ESP“ – External Static Pressure of the Fan (data per piece)	45 Pa
<b>WATER SIDE HEAT EXCHANGER</b>	
Type	Plate heat exchanger
Pressure drop	30 kPa
Dimensions of water piping connection	G1"
<b>ALLOWABLE FLOW - SECONDARY (WATER) SIDE</b>	
Min. water flow	1,15 m <sup>3</sup> /h
Nominal water flow	1,44 m <sup>3</sup> /h
Max. water flow	2,16 m <sup>3</sup> /h
<b>SOUND POWER AND PRESSURE LEVEL</b>	
Sound power level L <sub>wA</sub> - Indoor unit	45 dB(A)
Sound power level L <sub>wA</sub> - Outdoor unit	58 dB(A)
<b>SOUND PRESSURE LEVEL ON DISTANCE</b>	
Indoor unit - 1 m	37 dB(A)
Outdoor unit - 1 m	50 dB(A)
Outdoor unit - 5 m	36 dB(A)
Outdoor unit - 10 m	30 dB(A)
Outdoor unit - 15 m	26 dB(A)
<b>NET DIMENSIONS</b>	
Indoor unit (WxHxD)	600 x 1862 x 750 mm
Outdoor unit (WxHxD)	1056,5 x 765 x 414 mm
<b>NET WEIGHT</b>	
Indoor unit	190 kg
Outdoor unit	65 kg
<b>SERIAL INTEGRATED COMPONENTS</b>	
Electrical flow heater	6 kW (1ph / 2 stages)
Circulation water pump - A energy class	Grundfos UPM3K FELEX 25-75 180
3-way diverting valve for DHW tank	Serial integrated

## 1.6.2 AEROGOR ECO INVERTER 10 AS, 13 AS

MODEL	ECO INVERTER 10 AS	ECO INVERTER 13 AS
ErP Energy efficiency class	A++	A++
SCOP 35°C (floor heating) EN 14825	3,83	4,08
P <sub>design</sub> for SCOP EN 14825	6,3 kW	7,46 kW
<b>HEATING MODE (A7/W35)</b>		
Heating capacity*	4,57 – 10,67 kW	4,15 – 12,2 kW
COP - Coefficient of Performance*	5,05	5,14
Rated input power*	0,92 – 3,03 kW	0,96 - 3,02 kW
Max. temperature of heating water	55 °C	55 °C
Operating range of heat pump - Heating (Ambient temp.)	-25 do +45 °C	-25 do +45 °C
<b>COOLING MODE (A35/W7)</b>		
Cooling capacity**	2,60 – 8,00 kW	2,34 – 7,91 kW
Rated input power**	1,10 – 3,50 kW	0,97 – 2,98 kW
EER - Energy Efficiency Ratio**	3,22	3,03
Min. temperature of cooling water	7 °C	7 °C
Operating range of heat pump - Cooling (Ambient temp.)	0 to +65 °C	0 to +65 °C
<b>POWER SUPPLY - SPECIFICATION</b>		
Voltage	220-240 V/50 Hz/1 Ph	220-240 V/50 Hz/1 Ph
Fuse for heat pump	1 X 1p/20A/C	1 X 1p/20A/C
Fuse for electrical flow heater	3 X 1p/10A/C	3 X 1p/10A/C
<b>REFRIGERANT SPECIFICATION</b>		
Type of refrigerant	R410A	R410A
Refrigerant - mass	1,9 kg	3 kg
GWP (global warming potential)	2088 GWP	2088 GWP
Quantity of hydrofluorocarbons in tonnes of CO <sub>2</sub> equivalent	3,967 t CO <sub>2</sub> Equiv.	6,264 t CO <sub>2</sub> Equiv.
Type of compressor	DC inverter (twin rotary)	DC inverter (twin rotary)
Hermetically sealed equipment (indoor/outdoor unit)	Yes	Yes
Type fo connection between outdoor-indoor unit	Refrigerant connection	Refrigerant connection
Dimensions of refrigerant pipes connectors	3/8" - 1/2"	3/8" - 5/8"
<b>FAN</b>		
Fan type	1 x Axial	2 x Axial
Air flow	3100 m <sup>3</sup> /h	4100 m <sup>3</sup> /h
Rated power	60 W	2 x 60 W
„ESP“ – External Static Pressure of the Fan (data per piece)	45 Pa	50 Pa
<b>WATER SIDE HEAT EXCHANGER</b>		
Type	Plate heat exchanger	Plate heat exchanger
Pressure drop	30 kPa	40 kPa
Dimensions of water piping connection	G1"	G1"
<b>ALLOWABLE FLOW - SECONDARY (WATER) SIDE</b>		
Min. water flow	1,15 m <sup>3</sup> /h	1,32 m <sup>3</sup> /h
Nominal water flow	1,44 m <sup>3</sup> /h	2,2 m <sup>3</sup> /h
Max. water flow	2,16 m <sup>3</sup> /h	2,63 m <sup>3</sup> /h
<b>SOUND POWER AND PRESSURE LEVEL</b>		
Sound power level L <sub>wA</sub> - Indoor unit	45 dB(A)	46 dB(A)
Sound power level L <sub>wA</sub> - Outdoor unit	58 dB(A)	59 dB(A)
<b>SOUND PRESSURE LEVEL ON DISTANCE</b>		
Indoor unit - 1 m	37 dB(A)	38 dB(A)
Outdoor unit - 1 m	50 dB(A)	51 dB(A)
Outdoor unit - 5 m	36 dB(A)	37 dB(A)
Outdoor unit - 10 m	30 dB(A)	31 dB(A)
Outdoor unit - 15 m	26 dB(A)	27 dB(A)
<b>NET DIMENSIONS</b>		
Indoor unit (WxHxD)	505 x 946 x 288 mm	512 x 932 x 303,5 mm
Outdoor unit (WxHxD)	1056,5 x 765 x 414 mm	1154 x 1195 x 460 mm
<b>NET WEIGHT</b>		
Indoor unit	47 kg	47 kg
Outdoor unit	65 kg	113 kg
<b>SERIAL INTEGRATED COMPONENTS</b>		
Electrical flow heater	6 kW (3ph / 2 stages)	6 kW (3ph / 2 stages)
Circulation water pump - A energy class	Grundfos UPM GEO 25-85 180	Grundfos UPM GEO 25-85 180
3-way diverting valve for DHW tank	Included	Included

### 1.6.3 AEROGOR POWER EVI INVERTER 15 AS, 18 AS

MODEL	POWER EVI INVERTER 15 AS	POWER EVI INVERTER 18 AS
ErP Energy efficiency class	A+	A+
SCOP 35°C (floor heating) EN 14825	3,46	3,42
P <sub>design</sub> for SCOP EN 14825	10,97 kW	13,48 kW
<b>HEATING MODE (A7/W35)</b>		
Heating capacity*	5,96 - 14,50 kW	8,2 - 18,0 kW
Rated input power*	1,53 - 4,92 kW	1,53 - 4,92 kW
COP - Coefficient of Performance*	4,46	4,43
Max. temperature of heating water	55 °C	55 °C
Operating range of heat pump - Heating (Ambient temp.)	-25 do +45 °C	-25 do +45 °C
<b>COOLING MODE (A35/W7)</b>		
Cooling capacity**	5,56 - 10,00 kW	6,4 - 15,1 kW
Rated input power**	1,57 - 3,82 kW	2,19 - 6,42 kW
EER - Energy Efficiency Ratio**	3,52	2,92
Min. temperature of cooling water	7 °C	7 °C
Operating range of heat pump - Cooling (Ambient temp.)	0 to +65 °C	0 to +65 °C
<b>POWER SUPPLY - SPECIFICATION</b>		
Voltage	380-415 V/50 Hz/3 Ph	380-415 V/50 Hz/3 Ph
Fuse for heat pump	1 x 3p/16A/C	1 x 3p/16A/C
Fuse for electrical flow heater	3 x 1p/10A/C	3 x 1p/10A/C
<b>REFRIGERANT SPECIFICATION</b>		
Type of refrigerant	R410A	R410A
Refrigerant - mass	6,2 kg	6,6 kg
GWP (global warming potential)	2088 GWP	2088 GWP
Quantity of hydrofluorocarbons in tones of CO <sub>2</sub> equivalent	12,946 t CO <sub>2</sub> Equiv.	13,781 t CO <sub>2</sub> Equiv.
Type of compressor	Scroll EVI DC Inverter	Scroll EVI DC Inverter
Hermetically sealed equipment (indoor/outdoor unit)	Yes	Yes
Type fo connection between outdoor-indoor unit	Refrigerant connection	Refrigerant connection
Dimensions of refrigerant pipes connectors	3/8" - 3/4"	3/8" - 3/4"
<b>FAN</b>		
Fan type	2 x Axial	2 x Axial
Air flow	4200 m <sup>3</sup> /h	4500 m <sup>3</sup> /h
Rated power	2 x 80 W	2 x 80 W
„ESP“ – External Static Pressure of the Fan (data per piece)	50 Pa	50 Pa
<b>WATER SIDE HEAT EXCHANGER</b>		
Type	Plate heat exchanger	Plate heat exchanger
Pressure drop	35	35
Dimensions of water piping connection	G1"	G1"
<b>ALLOWABLE FLOW - SECONDARY (WATER) SIDE</b>		
Min. water flow	1,4 m <sup>3</sup> /h	1,86 m <sup>3</sup> /h
Nominal water flow	2,56 m <sup>3</sup> /h	3,09 m <sup>3</sup> /h
Max. water flow	2,7 m <sup>3</sup> /h	3,7 m <sup>3</sup> /h
<b>SOUND POWER AND PRESSURE LEVEL</b>		
Sound power level L <sub>wA</sub> - Indoor unit	47 dB(A)	52 dB(A)
Sound power level L <sub>wA</sub> - Outdoor unit	68 dB(A)	72 dB(A)
<b>SOUND PRESSURE LEVEL ON DISTANCE</b>		
Indoor unit - 1 m	39 dB(A)	44 dB(A)
Outdoor unit - 1 m	60 dB(A)	65 dB(A)
Outdoor unit - 5 m	46 dB(A)	51 dB(A)
Outdoor unit - 10 m	40 dB(A)	45 dB(A)
Outdoor unit - 15 m	36 dB(A)	41 dB(A)
<b>NET DIMENSIONS</b>		
Indoor unit (WxHxD)	512 x 932 x 303,5 mm	512 x 932 x 303,5 mm
Outdoor unit (WxHxD)	1241 x 1195 x 460 mm	1443 x 1294 x 460 mm
<b>NET WEIGHT</b>		
Indoor unit	50 kg	55 kg
Outdoor unit	151 kg	180 kg
<b>SERIAL INTEGRATED COMPONENTS</b>		
Electrical flow heater	6 kW (3ph / 2 stages)	6 kW (3ph / 2 stages)
Circulation water pump - A energy class	Grundfos UPM GEO 25-85 180	Grundfos UPMXL GEO25-125 130
3-way diverting valve for DHW tank	Included	Included

(\*) Measured according to standard EN 14511. Heating condition: water inlet/outlet temperature 30°C/35°C, ambient temperature DB/WB 7°C/6°C.

(\*\*) Measured according to standard EN 14511. Cooling condition: water inlet/outlet temperature 12°C/7°C and ambient temperature 35°C.

## 1.7 DIMENSIONS

### 1.7.1 INDOOR UNITS

#### ALL-IN-ONE 10 AS

Unit: mm

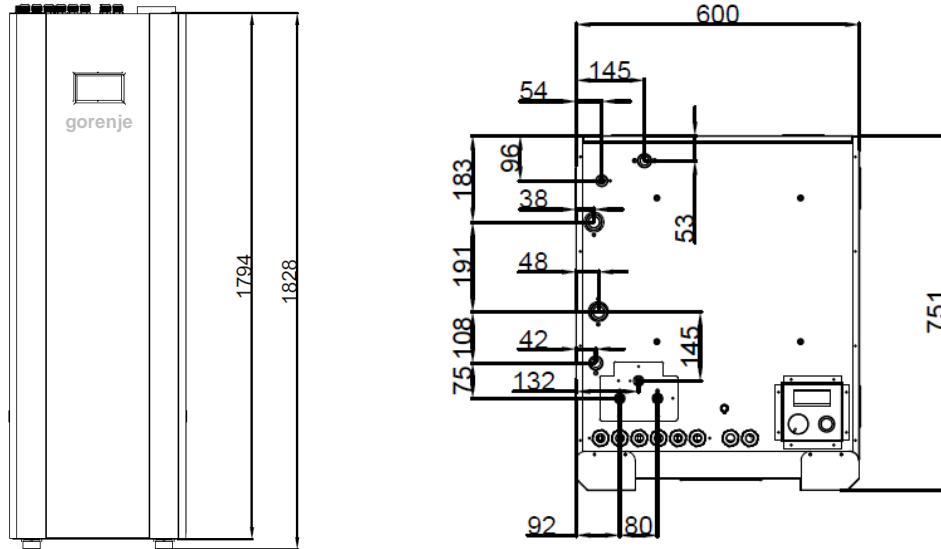

#### ECO 10 AS ECO 13 AS POWER EVI 15 AS POWER EVI 18 AS

Unit: mm

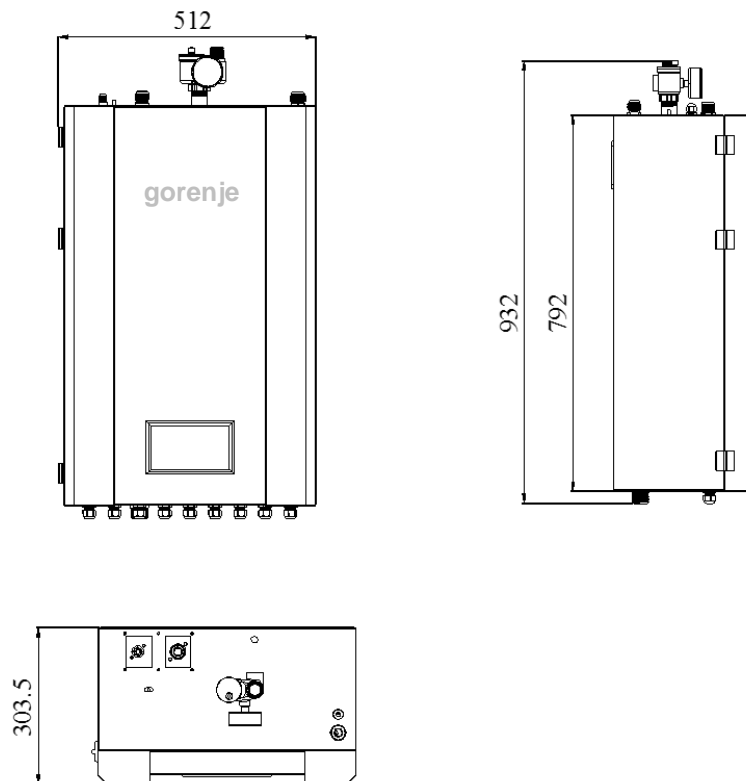

**1.7.2 OUTDOOR UNITS**

**AEROGOR ALL-IN-ONE INVERTER 10 AS, AEROGOR ECO INVERTER 10 AS**

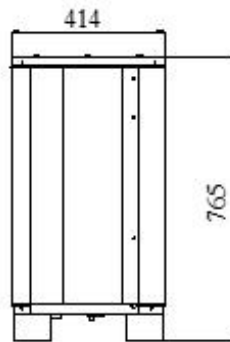
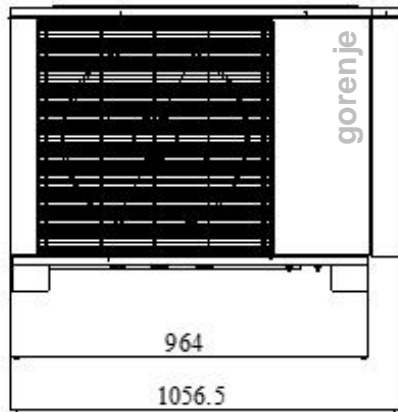
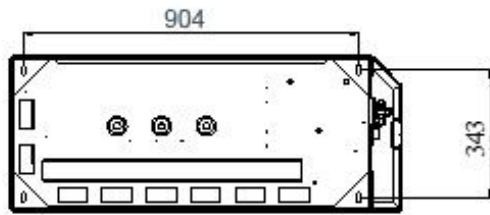

**AEROGOR ECO INVERTER 13 AS**

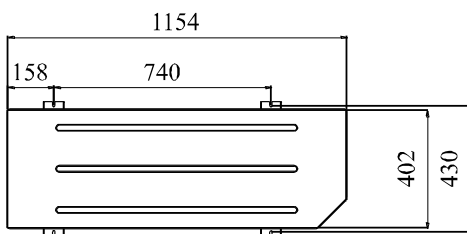
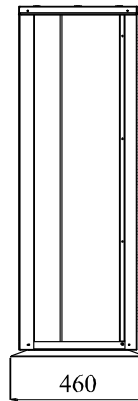
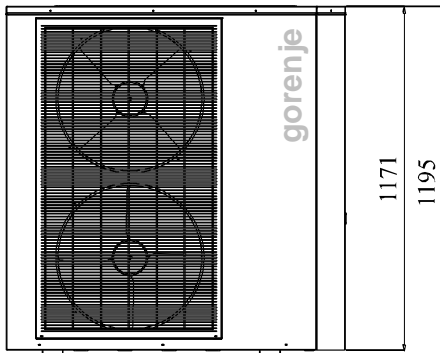



**AEROGOR POWER EVI INVERTER 15 AS**

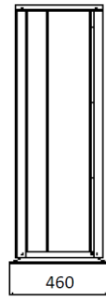
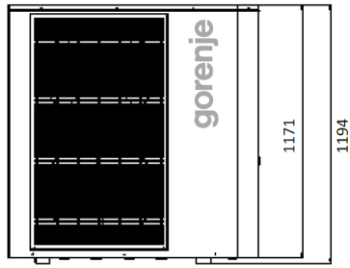

**AEROGOR POWER EVI INVERTER 18 AS**

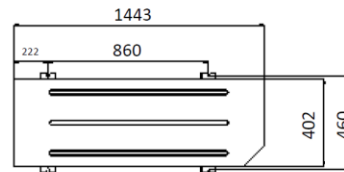
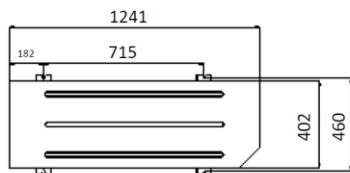
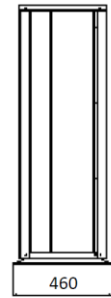
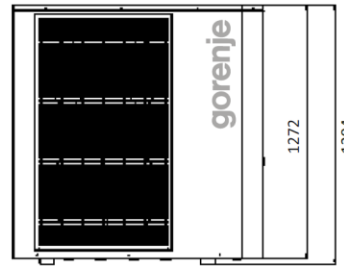

**1.8 OPERATING RANGE**

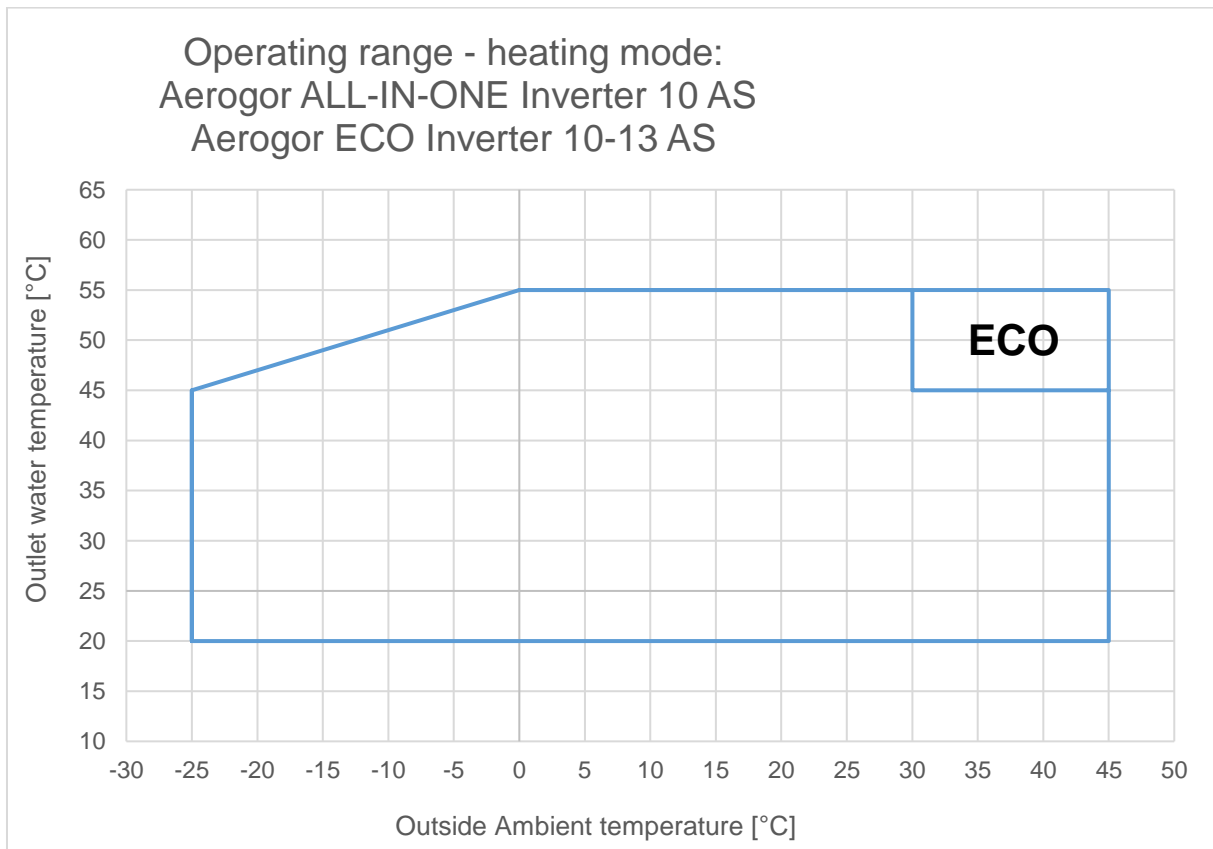

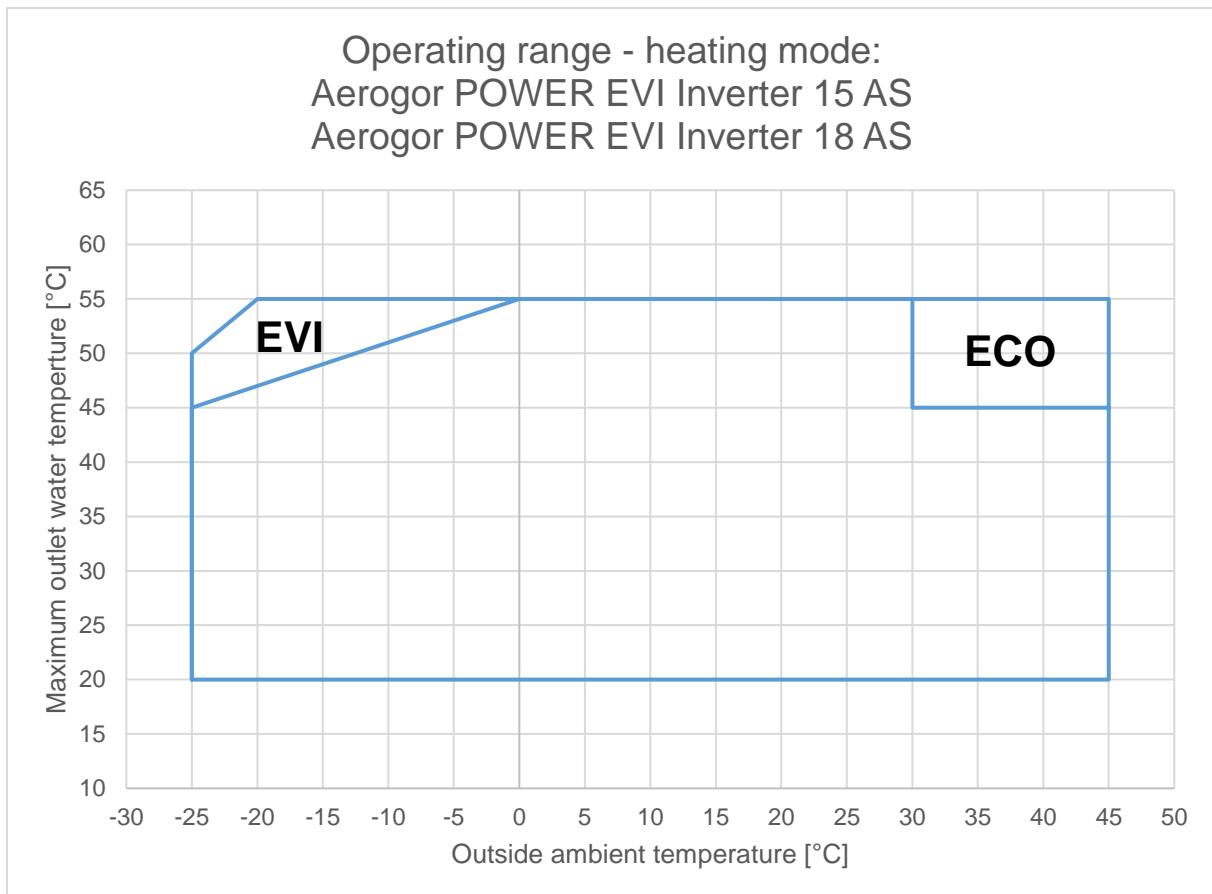

## 1.9 WORKING PRINCIPLE

A heat pump operates similarly as a refrigerator. In a refrigerator, liquids evaporate due to received thermal energy from the surrounding air and this energy is emitted at a desired spot during condensation (Carnot's cycle). A heat pump works in the opposite direction: it accepts thermal energy from the surrounding air and emits it in heated premises, using the natural heat collector of the environment. Ground and surface water, earth's warmth, solar energy and ambient air can be used as energy sources. The system is composed of four units: evaporator, compressor, condenser and damper. Heat energy is transferred via the coolant. In the evaporator, the coolant receives heat energy and evaporates. In the compressor, the vapour is compressed, which makes it heat up intensively. This hot vapour transmits thermal energy from the condenser to the heating water and liquefies. In the damper, the coolant expands (pressure reduces to the starting pressure, from there it proceeds to the evaporator and the cycle repeats).

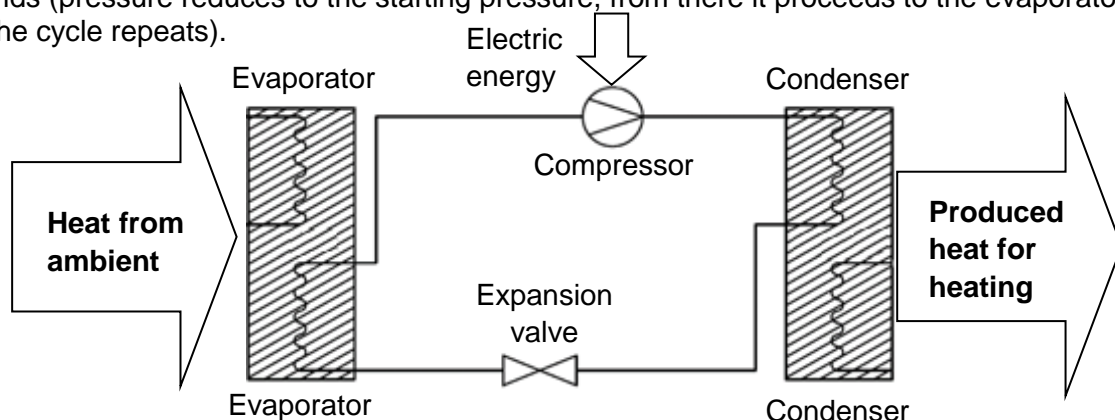

Inverter heat pumps use variable-speed compressors. Traditional heat pumps use fixed power/rotation speed compressors. In inverter compressors, the compressor speed constantly adapts to the heat losses of the room and the energy value of the source (air, brine or water, depending on the system). In traditional heat pumps, the power of the compressor is always the same. Compressor starts with full power and when it achieves the desired values/temperatures, it shuts off and waits until it restarts. Inverter heat pumps work for a longer period, but with lower power (adjusting to the premises), which means lower consumption of electric energy.

## 1.10 MAIN COMPONENTS

### 1.10.1 INDOOR UNITS

#### 1.10.1.1 AEROGOR ALL-IN-ONE INVERTER 10AS

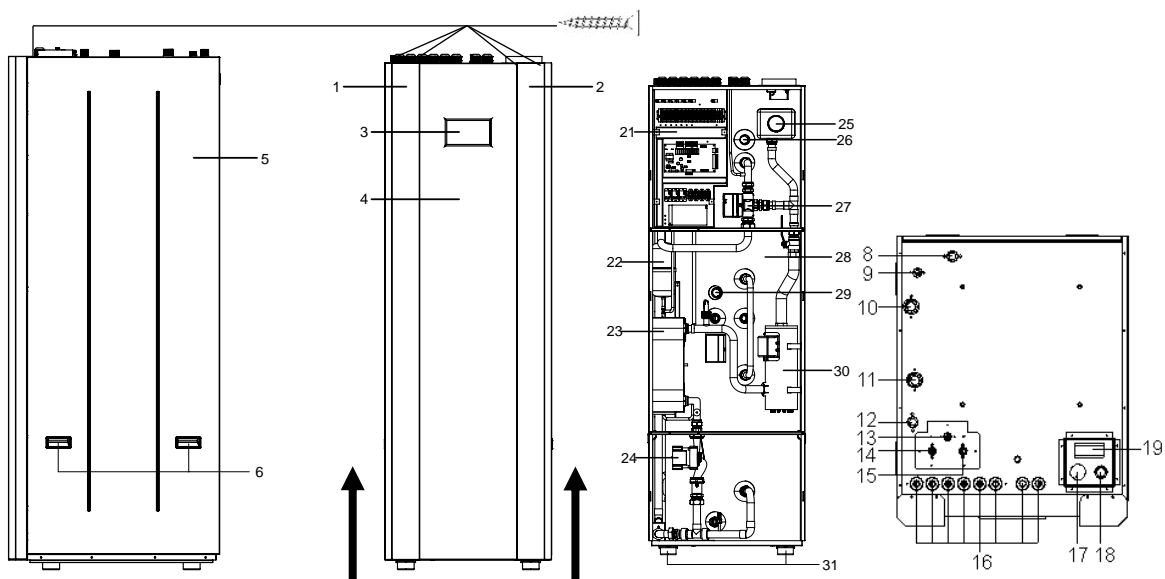

1	Decorative panel – Left	16	Cable Gland
2	Decorative panel – Right	17	Mechanical Thermostat
3	Touchscreen Controller Panel	18	Emergency switch (see page 80)
4	Front Panel	19	Digital thermostat
5	Side Panel – R	21	Electric box
6	Handle	22	1.5l Refrigerant tank
7	Side Panel - L	23	Plate heat exchanger
8	DHW Cold water 3/4"	24	Circulation Pump
9	DHW Circulation 1/2"	25	Safety Valve Kit
10	Heating/Cooling Return 1"	26	Magnesium Anode – 1
11	Heating/Cooling Output 1"	27	Motorized 3-way valve
12	DHW Hot water 3/4"	28	250l Enamelled tank
13	Pin Valve	29	Magnesium Anode – 2
14	Refrigerant Connector 3/8"	30	Electric heater
15	Refrigerant Connector 1/2"	31	Rubber damping

**1.10.1.2 AEROGOR ECO INVERTER 10AS/13AS AND AEROGOR POWER EVI INVERTER 15AS/18AS**

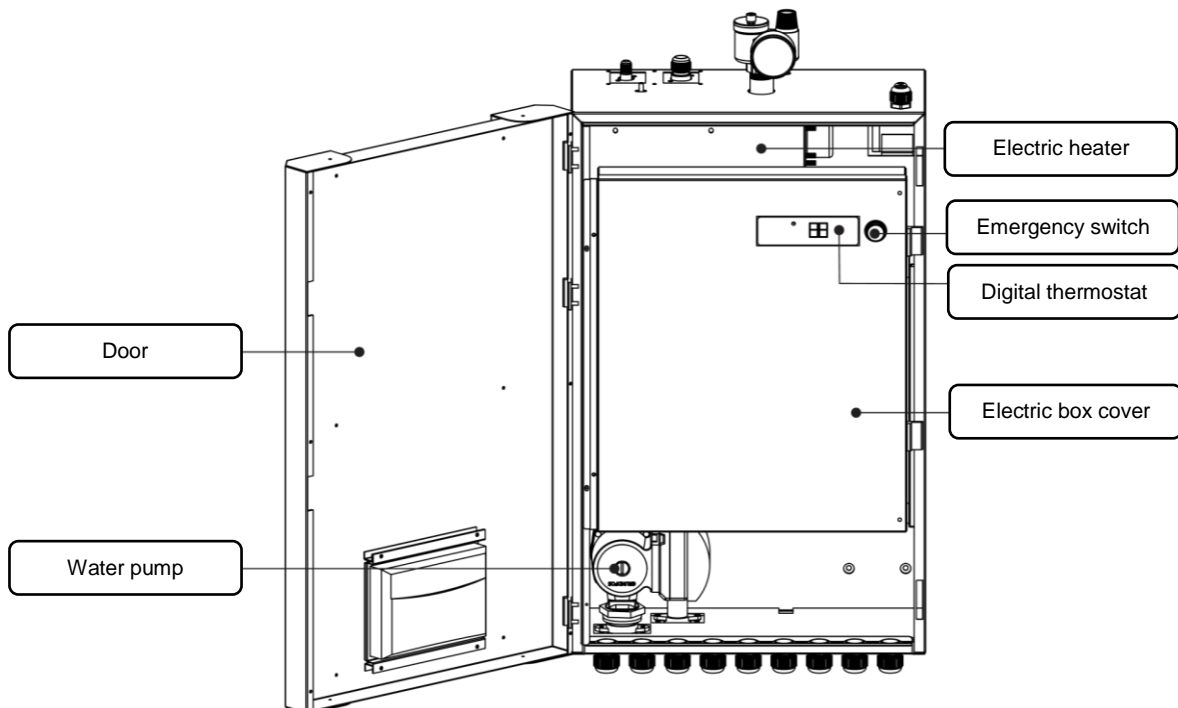
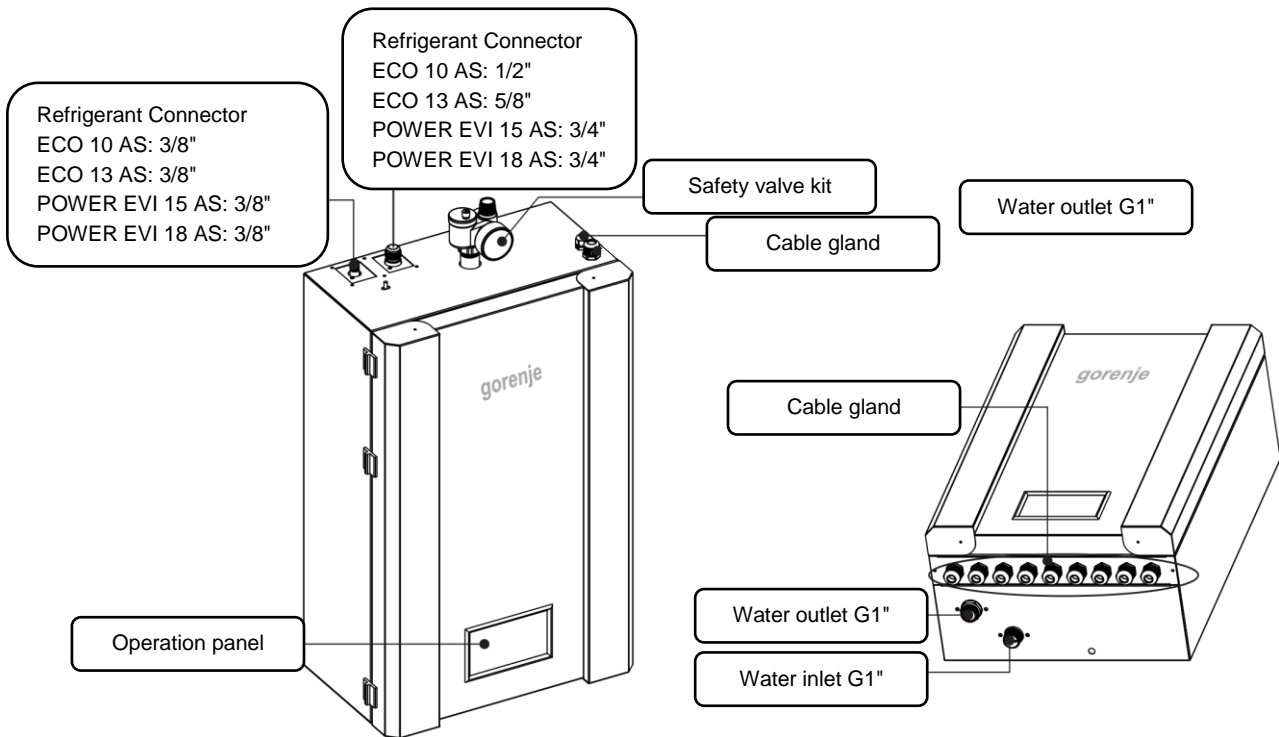

## 1.10.2 OUTDOOR UNITS

### 1.10.2.1 ALL-IN-ONE INVERTER 10 AS, AEROGOR ECO INVERTER 10 AS

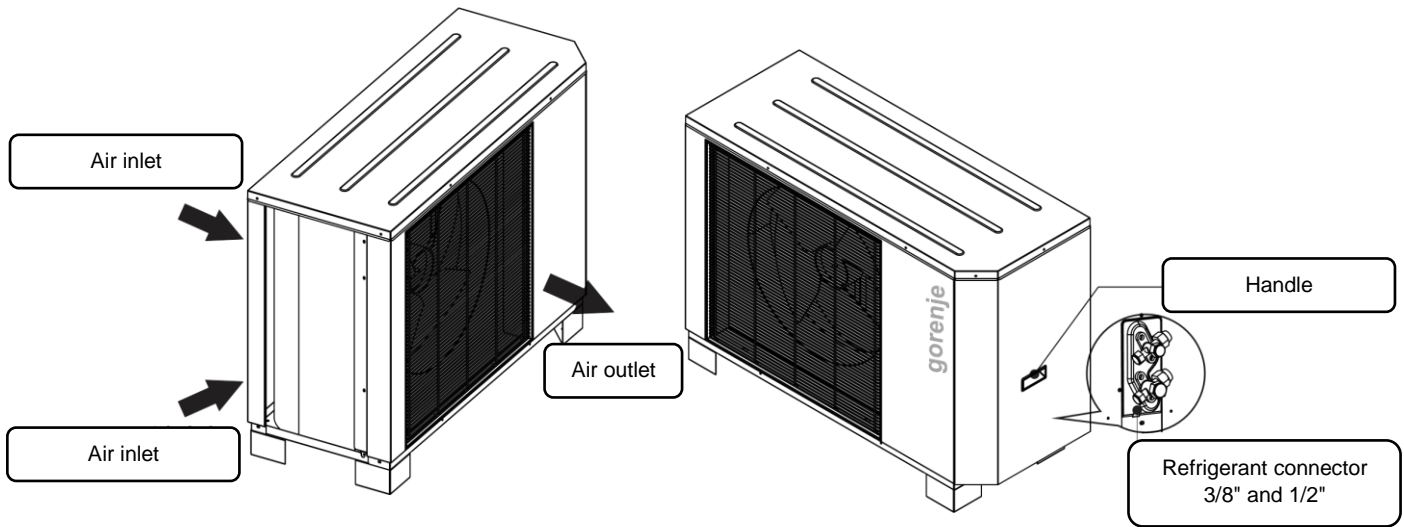

### 1.10.2.2 AEROGOR ECO INVERTER 13AS

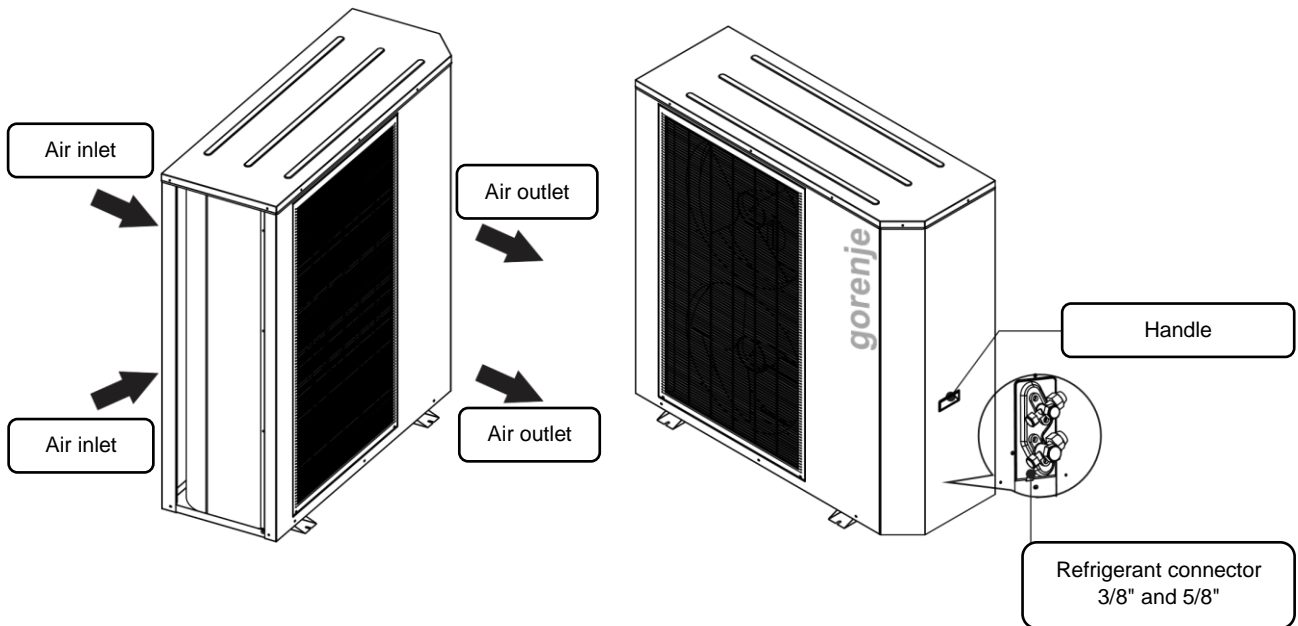

### 1.10.3 AEROGOR POWER EVI INVERTER 15 AS/ 18 AS

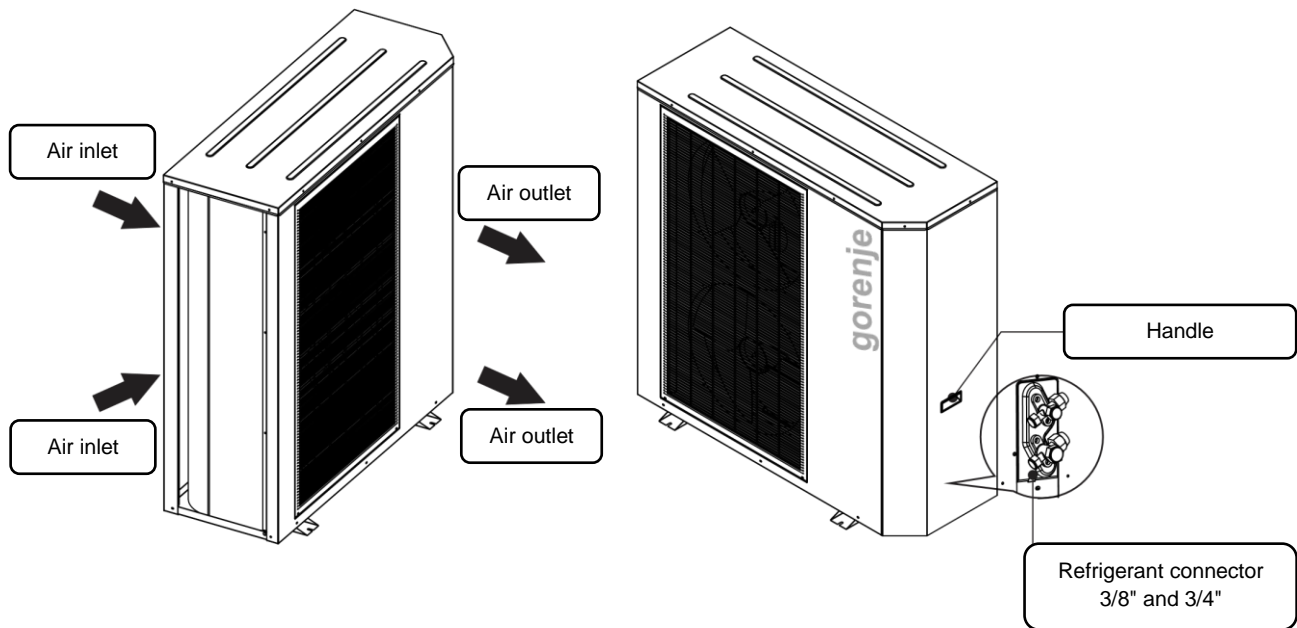

## 2 INSTALLATION

### 2.1 INSTALLATION OF THE INDOOR UNIT

#### INSTALLATION NOTES:

1. The indoor unit should be installed indoors and mounted on the wall with water connections facing downwards.
2. The indoor unit shall be placed in a dry and well-ventilated environment.
3. It is forbidden to install the indoor unit in an environment where there exist volatile, corrosive or flammable liquids or gases.
4. There should be enough space left around the indoor unit for further maintenance.

Please choose a suitable position to install the indoor unit as follows:

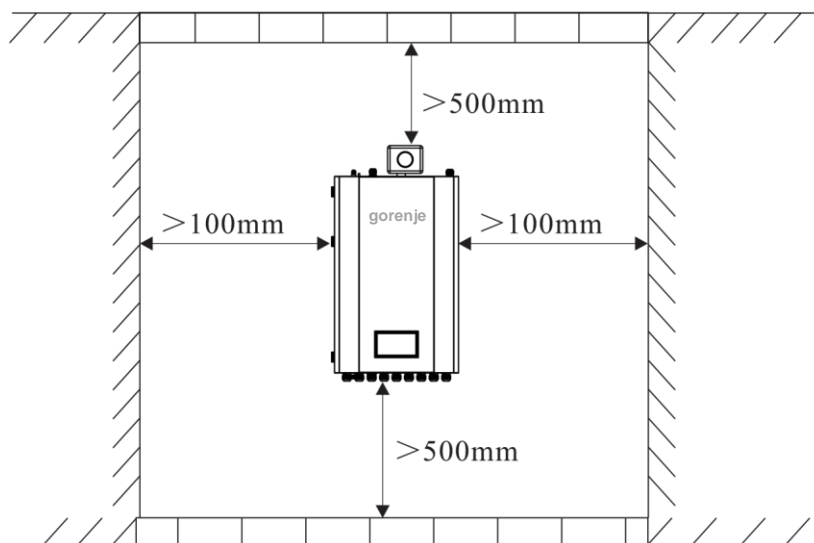

Indoor unit should be mounted on the wall as followed:

1. Take out the expansion bolts and mounting board from the box and put the mounting board on the wall horizontally.
2. Mark the location of the holes for the bolts on the wall.
3. Drill the holes with proper diameter for the expansion bolts.
4. Unscrew the nuts from the expansion bolts.
5. Fix the mounting board on the expansion bolts a little bit, but don't be too tight.
6. Use a hammer to pound the expansion bolts into the drilled holes.
7. Fasten the nuts by turning the wrench to fix the mounting board on the wall.
8. Hang the indoor unit onto the mounting board and make sure it's placed well before you let go your hands.
9. At this point, the installation is finished.

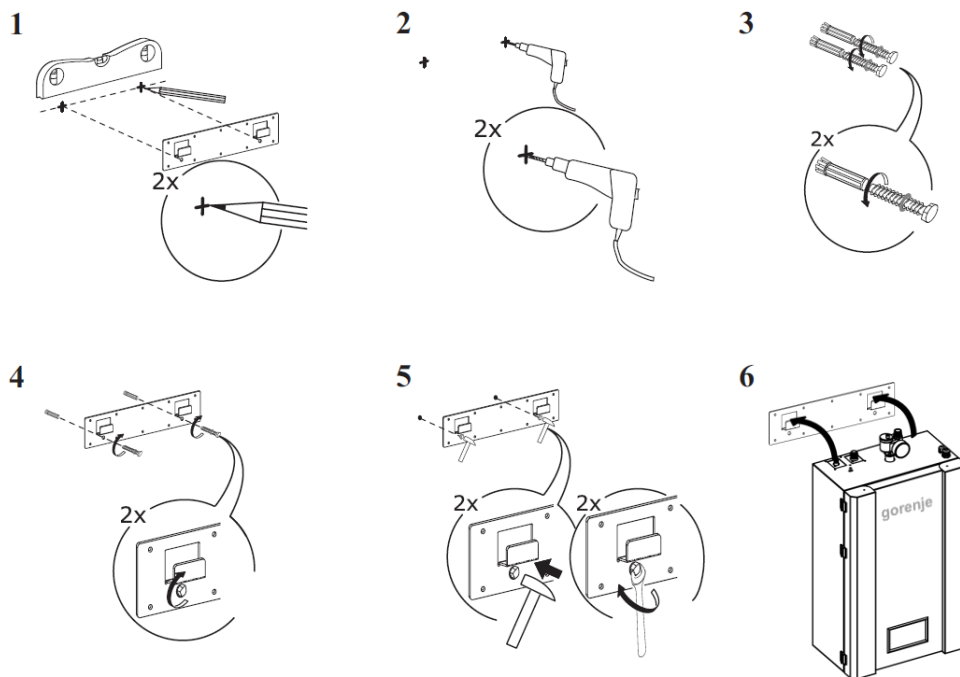

**Note:**

You must choose very firm wall for installation, otherwise the bolts may get loose and therefore damaging the unit.

## 2.2 INSTALLATION OF THE OUTDOOR UNIT

**INSTALLATION NOTES:**

1. The outdoor unit can be located in an open space, corridor, balcony, roof or hanged on the wall.
2. The outdoor unit shall be placed in dry and well-ventilated environment; If the outdoor unit is installed in a humid environment, electronic components may get corroded or short circuited.
3. Outdoor unit mustn't be installed in an environment where there exist volatile, corrosive or flammable liquids or gasses.
4. Please don't install outdoor unit close to bedroom or living room because it produces some noise when it's operating.
5. It is recommended to install an awning above the outdoor unit, to protect the snow from clogging in the air inlet and outlet to ensure normal operation.

6. Please ensure there is drainage system around the location to drain the condensate water under defrost mode.
7. When installing the unit, tilt it by 1 cm/m to enable rain water drainage.
8. Install outdoor unit far away from the exhaust port of the kitchen to avoid oil smoke entering into outdoor unit heat exchanger.
9. Please don't install the indoor and outdoor unit in damp locations. The units should be free from corrosive and moisture surrounding otherwise the lifetime of the unit might be shortened.
10. Please ensure enough space around the outdoor unit for better ventilation and maintenance.

Please refer to the illustration below.

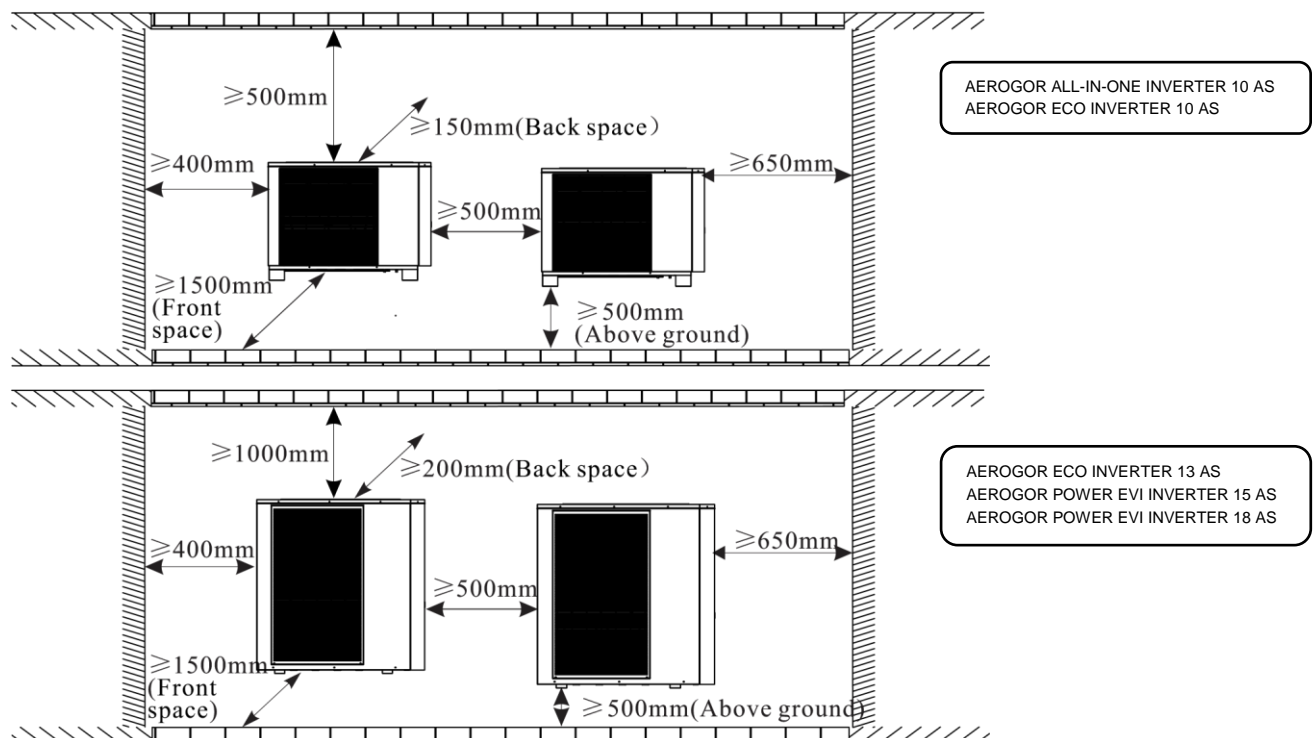

User can either use the dedicated mounting bracket from the supplier or prepare a suitable bracket for the unit installation. Make sure the installation meets the following requirements:

1. The unit must be installed on flat concrete blocks or a dedicated mounting bracket. The bracket should be able to support at least 5 times of the unit weight.
2. All nuts must be tightened after the bracket is fixed otherwise it may cause damage to the equipment.
3. Double check and make sure the installation of the unit is firm enough.
4. The bracket can be made from stainless steel, galvanized steel, aluminium and other materials as required by the user.
5. Besides the mounting bracket, the user can also install the outdoor unit on two concrete blocks or a raised concrete platform. Please make sure that the unit is securely fastened after installation.
6. Please see the dimensions of outdoor unit when choosing a suitable wall bracket.

Hole for piping should lean a little bit to outside ( $\geq 8$  degrees) to keep the rain or condensate water from flowing back indoors.



## 2.3 FOUNDATION

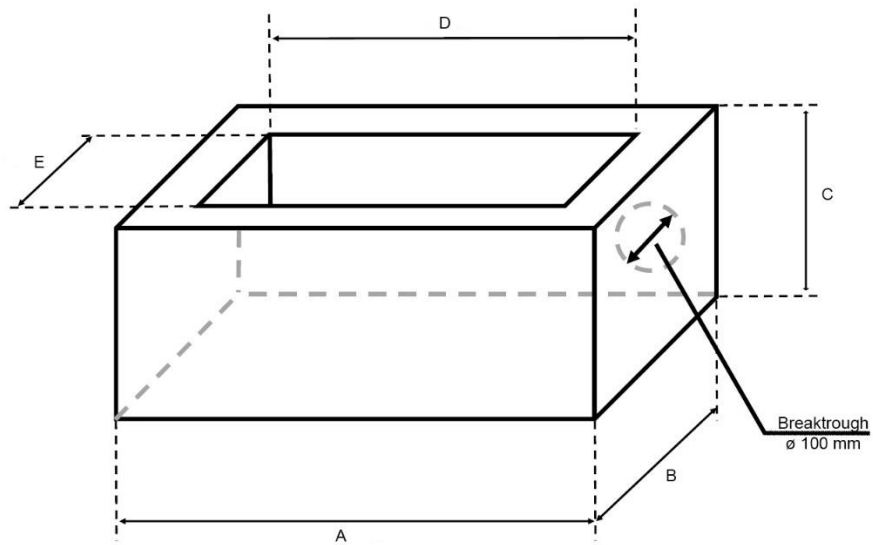

MODEL	SIZE (mm)				
	A	B	C	D	E
<b>ALL-IN-ONE INVERTER 10 AS</b>	1230	600	500	1070	440
<b>ECO INVERTER 10 AS</b>	1230	600	500	1070	440
<b>ECO INVERTER 13 AS</b>	1320	600	500	1160	440
<b>POWER EVI INVERTER 15 AS</b>	1430	600	500	1270	440
<b>POWER EVI INVERTER 18 AS</b>	1700	600	500	1540	440

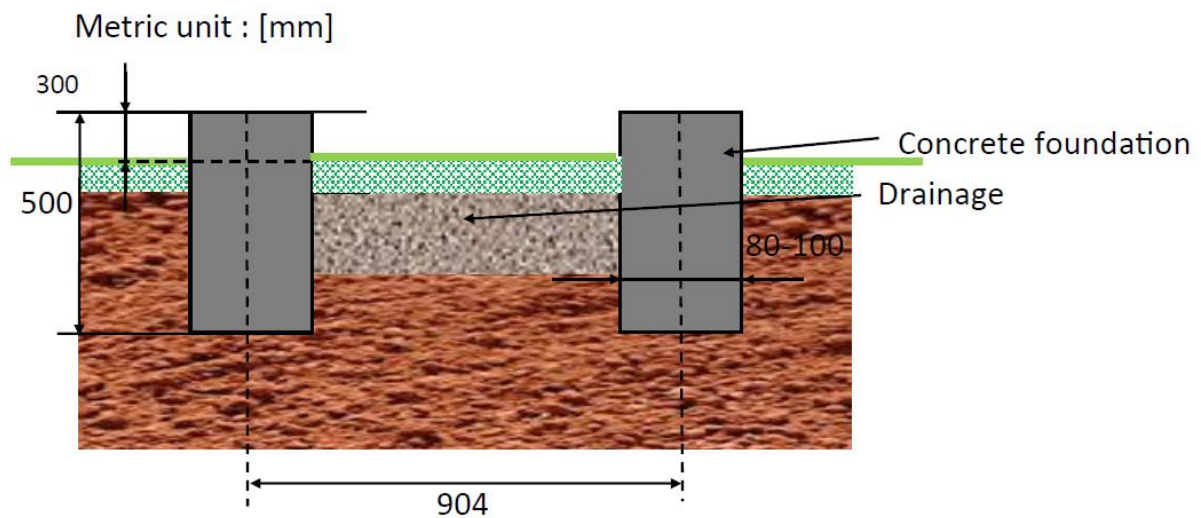

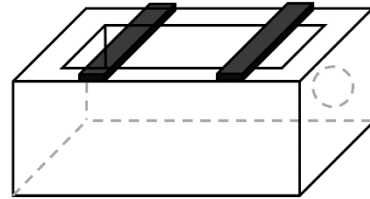
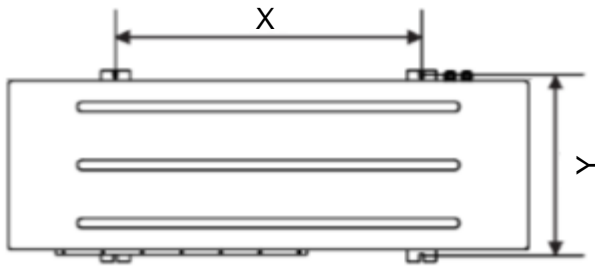

MODEL	SIZE (mm)	
	X	Y
ALL-IN-ONE INVERTER 10 AS	904	343
ECO INVERTER 10 AS	904	343
ECO INVERTER 13 AS	740	430
POWER EVI INVERTER 15 AS	720	430
POWER EVI INVERTER 18 AS	720	430

### 2.3.1 INSTALLATION OF C PROFILE AND LEGS

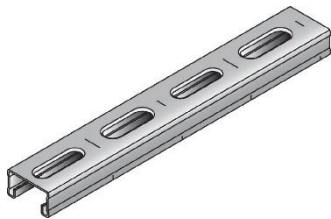

MM-C-16 Double installation profile

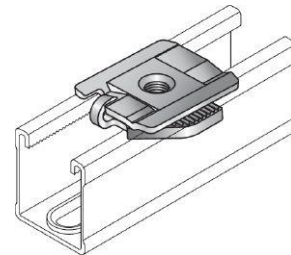

MM-S Connector for hose clamp

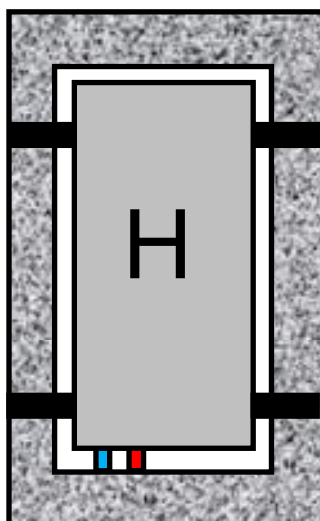

Plan view of the heat pump fixed on the foundation

## 2.4 INSTALATION OF THE REFRIGERANT SYSTEM (SPLIT TYPE)

### NOTE:

Only certified personnel are allowed to connect and operate with the refrigerant system.

It is forbidden to start the unit without Evacuating the refrigerant system.

Pipes used for installation must comply with the specifications of the heat pump

Before starting the unit, always check if the refrigerant connections are sealed and there is no leakage in the system.

The radius at pipe bends must not be less than 15 cm and the pipes have to be without flaws.

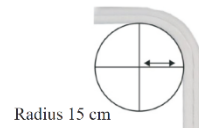

Do not let any dirt in the refrigerant system

Always use tools without flaws.

Always Evacuate the refrigerant to 500 microns or below.

Evacuating the refrigerant system at sub-zero temperatures is forbidden.

When insulating refrigerant pipes, insulate each pipe separately.

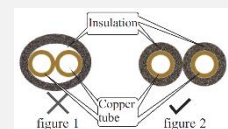

The split type heat pumps are **factory loaded** for a specific length. If the length is longer than factory load, please check that it **does not exceed the maximum length** shown in the table below:

REFRIGERANT PIPING LENGTH				
HEAT PUMP	FACTORY LOAD	MAXIMUM LENGTH	ADD	CONNECTIONS
ALL-IN-ONE Inverter 10 AS	5 meters	20 meters	40 g/m	3/8" and 1/2"
ECO Inverter 10 AS	5 meters	20 meters	40 g/m	3/8" and 1/2"
ECO Inverter 13 AS	12 meters	20 meters	40 g/m	3/8" and 5/8"
Power EVI Inverter 15 AS	15 meters	30 meters	60 g/m	3/8" and 3/4"
Power EVI Inverter 18 AS	15 meters	30 meters	60 g/m	3/8" and 3/4"

For each meter that is longer than the factory load, you must add additional refrigerant according to the table above.

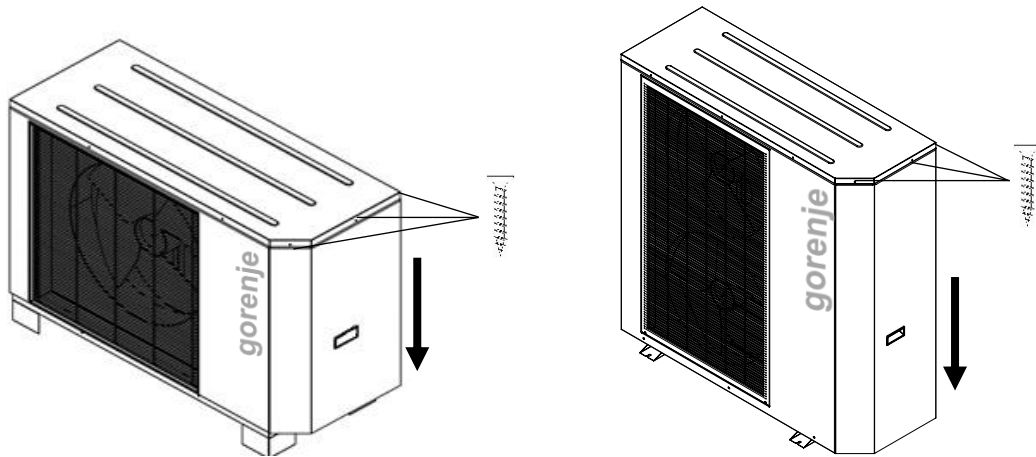

Unscrew the three screws and pull down the cover in order to get access to electrical and refrigerant connections.

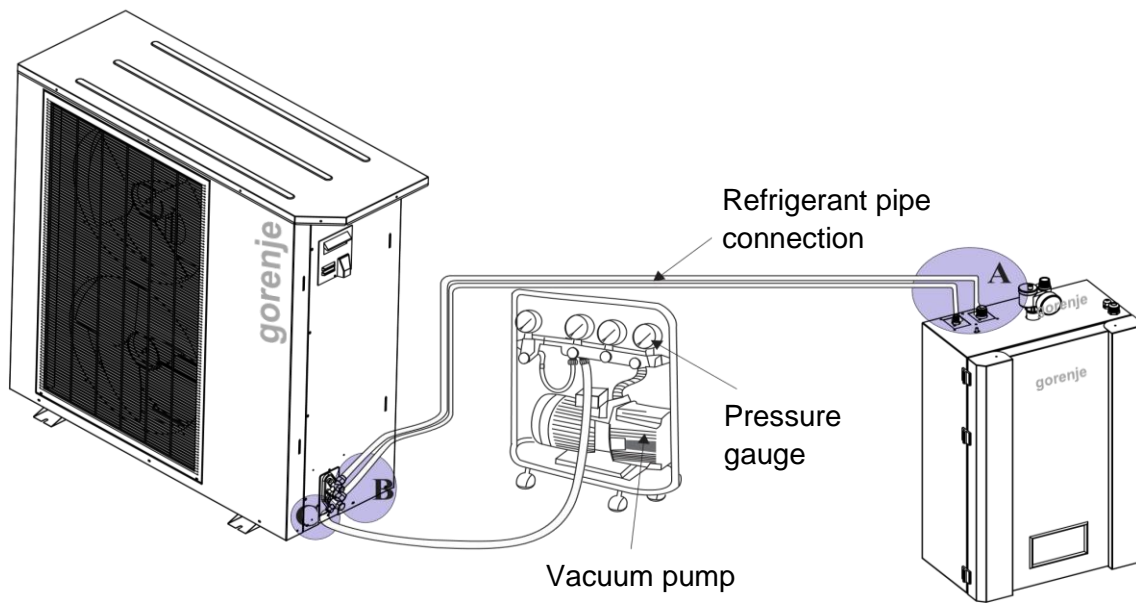

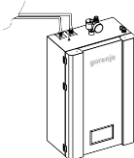
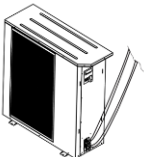
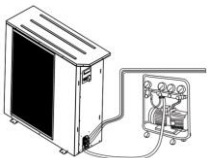
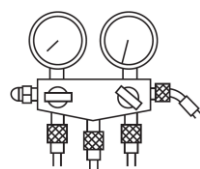
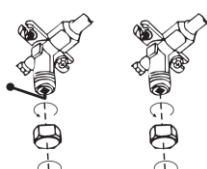
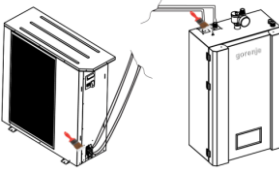
<p>A – Connect the refrigerant piping to the indoor unit.</p>	
<p>B - Connect the other end of the refrigerant pipes to the outdoor unit.</p>	
<p>C – Prepare a vacuum pump and a pressure gauge. Connect one tube of the pressure gauge to the vacuum pump and the other one to the high-pressure refrigerant connector on the outdoor unit.</p>	
<p>Open the pressure gauge and start the vacuum pump to vacuum the unit to 500 microns or below. After that close the pressure gauge and stop vacuuming.</p>	
<p>Take off the copper nuts off the connectors and open the valves with hexagon spanner as much as possible.</p>	
<p>Check if there is any leakage with leakage detector or soap water. If not, remove the tubes of the gauges and put back the copper nuts into the valves.</p>	

### 2.4.1 HEIGHT DIFFERENCE BETWEEN INDOOR AND OUTDOOR UNIT

Height difference between outdoor and indoor unit for Aerogor Inverter heat pumps

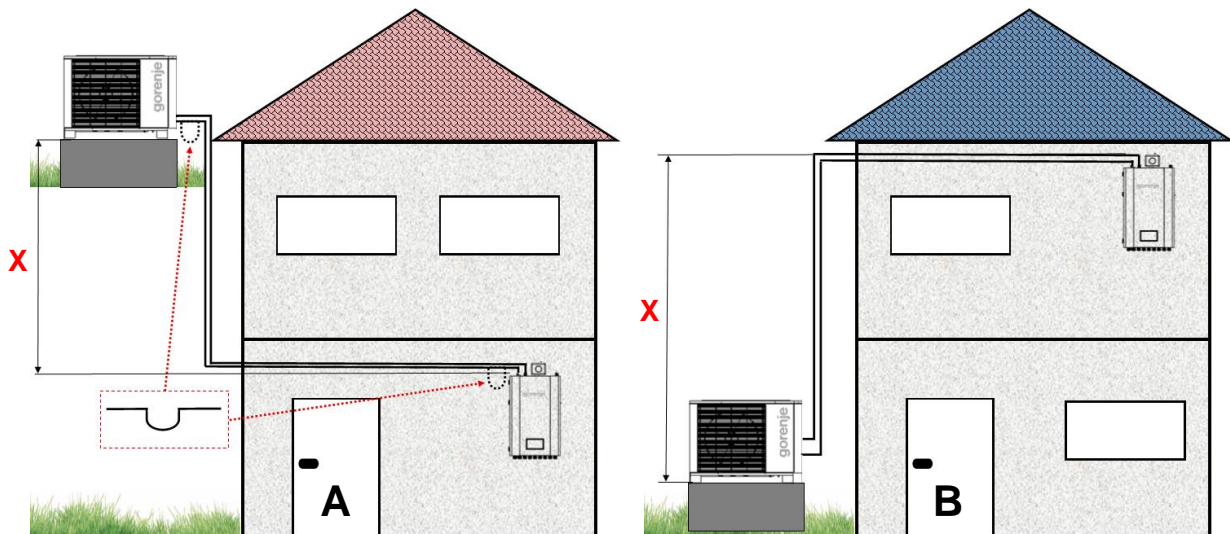

**A) Outdoor unit is **above** Indoor unit**

Maximum height difference is **X m**.

Total pipe length distance can be maximum **Y m**. In case of 7 m (**X**) height distance between indoor and outdoor unit, horizontal pipe distance can be maximum 5 m (**Z**).

**In that case is obligatory to integrate 1 siphon.**

**B) Outdoor unit is **below** Indoor unit**

Maximum height difference is **X m**.

Total pipe length distance can be maximum **Y m**. In case of 5 m height distance between indoor and outdoor unit, horizontal pipe distance can be maximum 7 m (**Z**).

• **OUTDOOR UNIT IS **ABOVE** INDOOR UNIT (House A)**

Model name	Maximum pipe length ( <b>Y</b> )	Outdoor unit is <b>above</b> Indoor unit max. height difference <b>X</b> [m]	Maximum horizontal pipe distance/number of siphons ( <b>Z</b> )
ALL-IN-ONE Inverter 10 AS	20 meters	7 m	11 meters / 2 siphons
Aerogor ECO Inverter 10 AS	20 meters	7 m	11 meters / 2 siphons
Aerogor ECO Inverter 13 AS	20 meters	7 m	11 meters / 2 siphons
Aerogor POWER EVI Inverter 15 AS	30 meters	7 m	21 meters / 2 siphons
Aerogor POWER EVI Inverter 18 AS	30 meters	7 m	21 meters / 2 siphons

- **OUTDOOR UNIT IS BELOW INDOOR UNIT (House B)**

<b>Model name</b>	<b>Maximum pipe length (Y)</b>	<b>Outdoor unit is below Indoor unit max. height difference X [m]</b>	<b>Maximum horizontal pipe distance/number of siphons (Z)</b>
ALL-IN-ONE Inverter 10 AS	20 meters	5 m	15 meters / 0 siphons
Aerogor ECO Inverter 10 A	20 meters	5 m	15 meters / 0 siphons
Aerogor ECO Inverter 13 A	20 meters	5 m	15 meters / 0 siphons
Aerogor POWER EVI Inverter 15 A	30 meters	5 m	25 meters / 0 siphons
Aerogor POWER EVI Inverter 18 A	30 meters	5 m	25 meters / 0 siphons

## 3 WIRING

### 3.1 AEROGOR ALL-IN-ONE INVERTER 10 AS, AEROGOR ECO INVERTER 10 AS, 13 AS AND AEROGOR POWER EVI INVERTER 15 AS, 18 AS

#### 3.1.1 INDOOR UNIT AEROGOR ALL-IN-ONE INVERTER 10AS

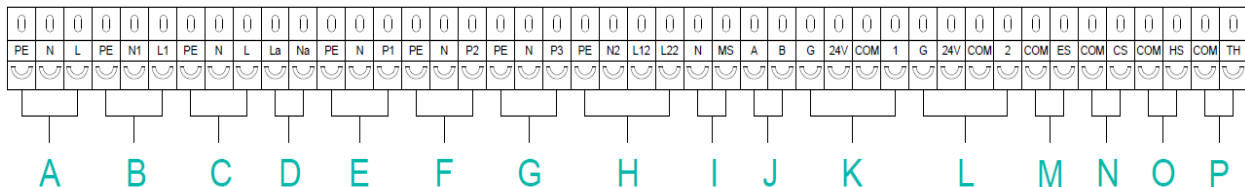

- A** HEAT PUMP POWER SUPPLY (FUUSE – 20 A 1P C)
- B** INTERNAL ELECTRICAL HEATERS POWER SUPPLY (FUUSE – 2x16 A 1P C)
- C** INDOOR TO OUTDOOR POWER CONNECTION (230 V) – 3x2,5 mm<sup>2</sup>
- D** CONSTANT 230 V RESERVE – MAX. LOAD 100 W
- E** CIRCULATING PUMP – HEATING/ COOLING CIRCUIT 1
- F** CIRCULATING PUMP – HEATING/ COOLING CIRCUIT 2
- G** CIRCULATING PUMP FOR DHW (230 V on P3 during DHW operation)
- H** POWER SUPPLY ELECTRICAL HEATER FOR DHW TANK (FUUSE – 1x 10A 1p C)
- I** MODE SWITCHING SIGNAL (see page 64)
- J** INDOOR TO OUTDOOR COMMUNICATION  
*Cable included in the package – 3x0,75 mm<sup>2</sup> Shielded*
- K** MIXING VALVE 1 (24 V DC Power supply, 0 – 10 V DC Signal)
- L** MIXING VALVE 2 (24 V DC Power supply, 0 – 10 V DC Signal)
- M** ELECTRICAL UTILITY LOCK (see page 64)
- N** EXTERNAL SWITCH INPUT FOR COOLING MODE (0/1) (see page 53)
- O** EXTERNAL SWITCH INPUT FOR HEATING MODE (0/1) (see page 53)
- P** EXTERNAL SWITCH INPUT FOR HIGH TEMPERATURE DEMAND (0/1) (see page 58,59)



### 3.1.2 INDOOR UNIT POWER AND ECO INVERTERS AS

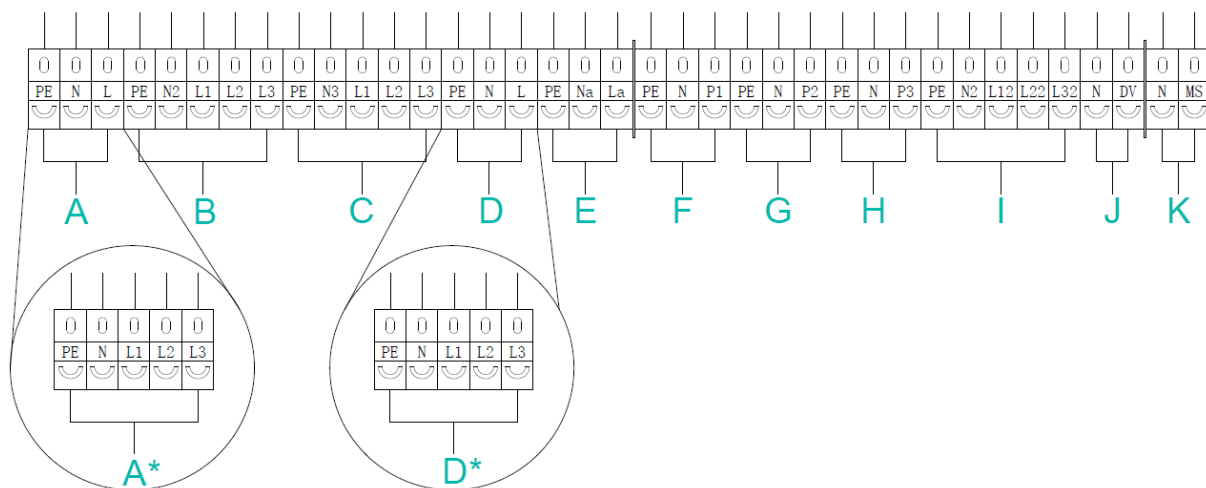

- A** HEAT PUMP POWER SUPPLY (FUUSE – 20 A 1P C)
- A\*** HEAT PUMP POWER SUPPLY (FUUSE – 16 A 3P C) (POWER EVI INVERTER 15 AS, 18 AS)
- B** INTERNAL ELECTRICAL HEATERS POWER SUPPLY (FUUSE – 3x10 A 1P C)
- C** POWER SUPPLY FOR ADDITIONAL ELECTRICAL HEATER FOR DHW TANK – DEPENDING ON THE TYPE
- D** INDOOR TO OUTDOOR POWER CONNECTION (230 V) – 3x2,5 mm<sup>2</sup>
- D\*** INDOOR TO OUTDOOR POWER CONNECTION (400 V) – 5x2,5 mm<sup>2</sup> (POWER EVI INVERTER 15 AS, 18 AS)
- E** CONSTANT 230 V RESERVE – MAX. LOAD 100 W
- F** CIRCULATING PUMP – HEATING/ COOLING CIRCUIT 1
- G** CIRCULATING PUMP – HEATING/ COOLING CIRCUIT 2
- H** CIRCULATING PUMP FOR DHW (230 V on P3 during DHW operation)
- I** ADDITIONAL ELECTRICAL HEATER FOR DHW TANK
- J** DIVERTING VALVE – DHW MODE WITH POWER
- K** MODE SWITCHING SIGNAL (see page 64)

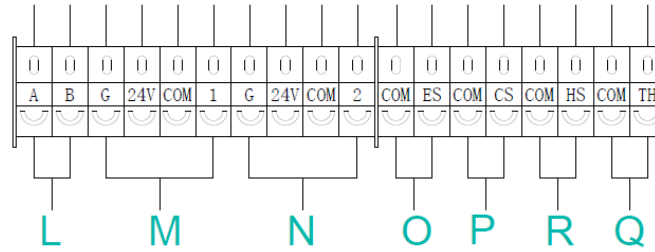

- L** INDOOR TO OUTDOOR COMMUNICATION  
Cable included in the package – 3x0,75  $mm^2$  Shielded
- M** MIXING VALVE 1 (24 V DC Power supply, 0 – 10 V DC Signal)
- N** MIXING VALVE 2 (24 V DC Power supply, 0 – 10 V DC Signal)
- O** ELECTRICAL UTILITY LOCK (see page 64)
- P** EXTERNAL SWITCH INPUT FOR COOLING MODE (0/1) (see page 53)
- R** EXTERNAL SWITCH INPUT FOR HEATING MODE (0/1) (see page 53)
- Q** EXTERNAL SWITCH INPUT FOR HIGH TEMPERATURE DEMAND (0/1) (see page 58,59)

### 3.1.3 TEMPERATURE SENSORS

Temperature sensors have quick connectors with marks.

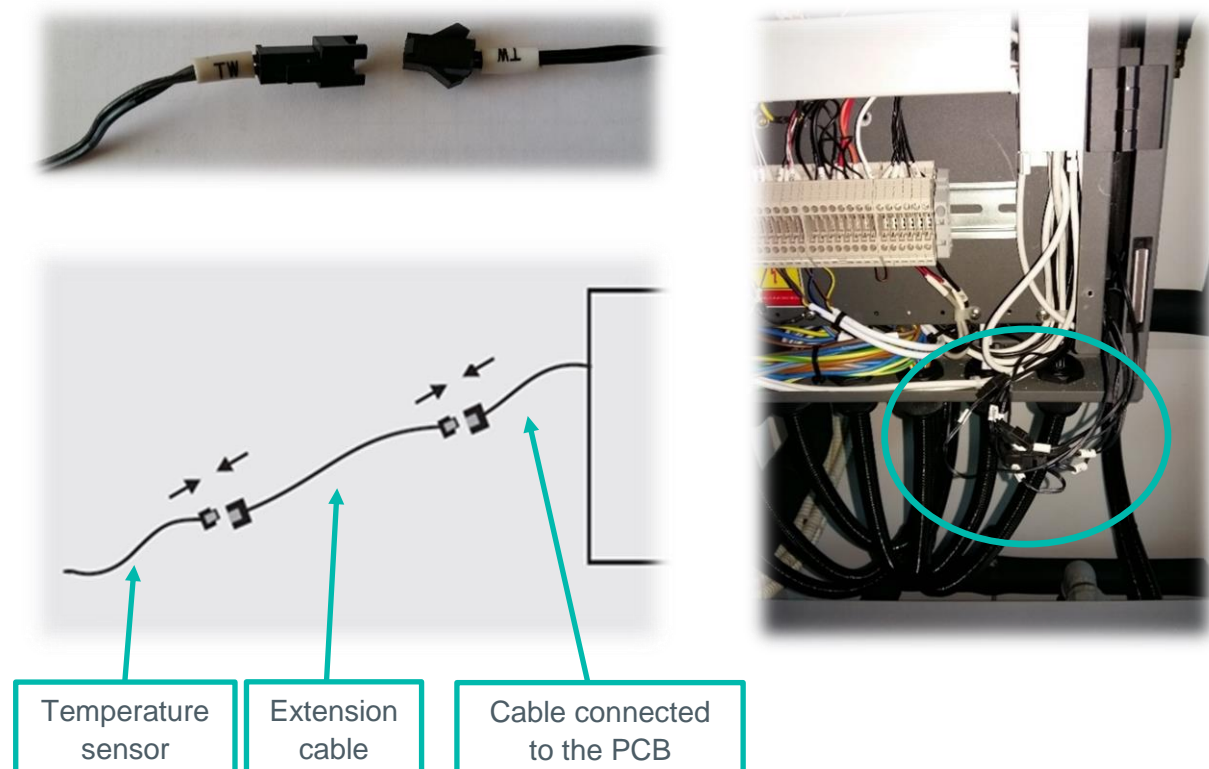

### 3.1.3.1 AMBIENT TEMPERATURE SENSOR

An Ambient Temperature Sensor is preinstalled on the outdoor unit. If the unit is mounted on the sunny side of the house, it is recommended to mount the Ambient Temperature Sensor to the shadow side of the house. For that reason, an additional ambient temperature sensor is added in the package. Disconnect the original mounted Ambient Temperature Sensor and connect the cable to the additional Ambient Temperature Sensor. The cable must not be bigger than  $2 \times 0,75 \text{mm}^2$  and shielded!



### 3.1.4 CONNECTION BETWEEN INDOOR AND OUTDOOR UNIT

Communication cables shield must be connected on one side, either indoor or outdoor unit.

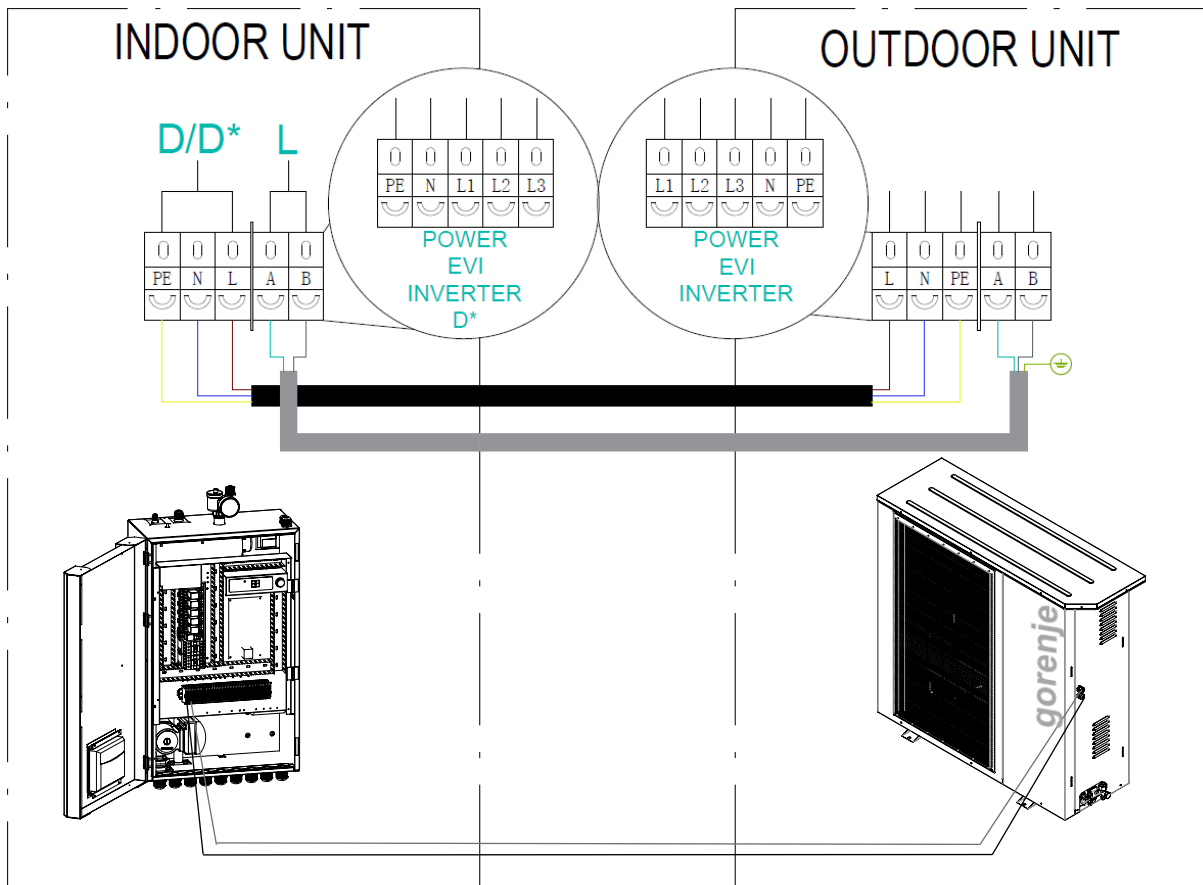

## 4 CONTROL UNIT

### 4.1 DESCRIPTION OF SYMBOLS ON THE CONTROL UNIT

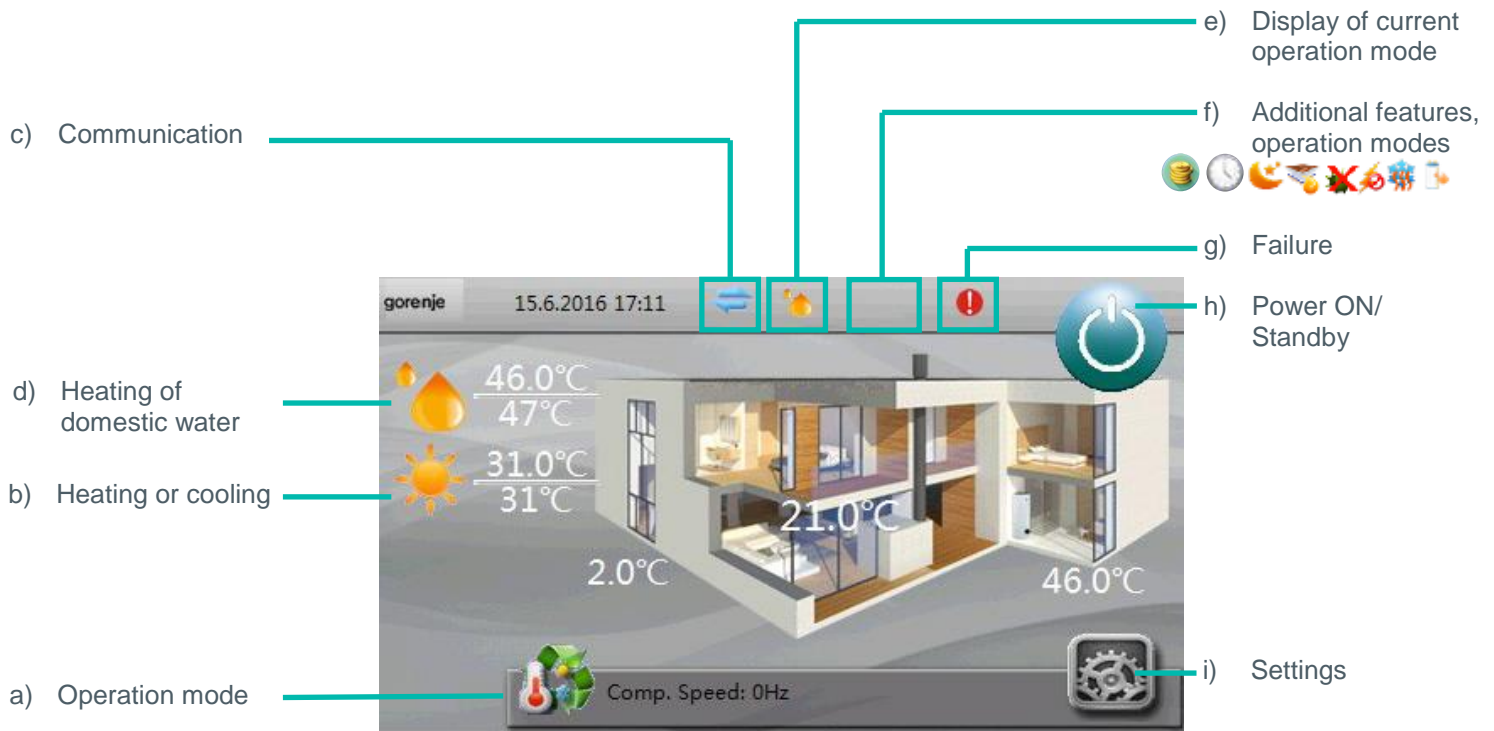

#### a) Operation mode

This symbol shows the operation mode of the heat pump. Two modes are possible: automatic or manual operation mode. With a short push on this symbol you can select the operation mode. The recommended setting is **automatic mode**.



#### Automatic operation mode

The heat pump automatically switches between heating or cooling the house and heating of domestic water!

#### Manual operation mode

In the manual Operation mode, the heat pump only prepares what you have selected and ignores timers and the ambient temperature!



Only heating of premises (without domestic water, cooling, timers...)



Only cooling of premises (without domestic water, heating, timers...)



Only domestic water (without heating, cooling, timers...)



QuickHeat DHW (Fast heating of the DHW to the set value with the help of additional heating sources. During QuickHeat, heating of premises is switched off. When the set value of DHW water is achieved, the unit continues in normal operation).

 If the “Pause” symbol is displayed, the heat pump is manually switched off!

**b) Heating or cooling indicator**  

The symbol indicates that heating or cooling by ambient temperature or thermostat is activated, or is activated due to manual operation mode!

Heating or cooling is activated or deactivated based on the ambient temperature!

Factory setting of enabled heating or cooling based on the ambient temperature:

 Heating – 18 °C

 Cooling – 25 °C

These values can be set as you wish.

**Example:**

Heating activation temperature is set to 18 °C. This means that when the average ambient temperature exceeds 18 °C, the heat pump will stop heating. The sun symbol will disappear from the display.

When the average ambient temperature drops below 18 °C, the sun symbol reappears on the display and the heat pump will reinitiate heating of the premises, unless an additional thermostat is used. In that case, the heat pump will require the deactivation of the thermostat.

**c) Activating the heating of domestic water** 

This symbol is visible on the display only when the heat pump is used for heating domestic water.

The symbol is always visible on the display, unless the domestic hot water timer is used.

If the domestic water timer is used, a different symbol appears in the domestic water heating regime.

**d) Communication** 

This symbol displays the communication status of the heat pump.

A light blue symbol indicates normal communication.

A grey symbol indicates loss of communication.

In this case, an error symbol is displayed as well. Please notify an authorized service person immediately!

**e) Display of the current Operation mode**

The heat pump displays the current Operation mode.









 Heating

 Cooling

 Heating of domestic water

 QuickHeat

**f) Additional features, modes of operation** 

-  This symbol appears when the reduced setpoint for heating is on (see chapter Reduced Setpoint for Heating on page 48).
-  This symbol appears when the “Floor Curing” feature is on (page 61).
-  This symbol appears when the heat pump is in the “Anti-Legionella” mode (page 49).
-  This symbol appears when “Electrical Utility Lock” is on (page 62).
-  This symbol appears when the heat pump is in the “Defrosting” mode (page 65).
-  This symbol appears when the timer for the preparation of domestic water is on (page 47).
-  This symbol appears when the timer for heating / cooling is active (page 51).
-  This symbol appears when Heating ECO operation is active (page 63).

**g) Warning or Error** 

An exclamation mark appears on the screen, cautioning about an error.

- Minor error; considered as a warning. Heat pump operates normally, but an authorized service person should be informed immediately!
- Major error; to ensure safety of the system and the heat pump, the pump is shut off. If the “Emergency Operation” feature is on, the heat pump will continue working, but only with backup heating sources!  
Please inform an authorized service person immediately!

**h) Power on/off** 

Heat pump power on/off.

**Heat pump on** means that the system is active for heating, cooling and preparation of hot domestic water! The symbol is blue! 

**Heat pump off** means that the system is switched off except for the Anti-freezing protection which is on! The symbol is grey! 

Anti-freezing protection protects the system from freezing. The heat pump automatically checks the water temperature. If it drops below a certain value, potentially causing system damage due to system water freezing, it turns on to increase the water temperature to a safe temperature level.

**i) Settings** 

This button can be used to access menus.

## 4.2 DESCRIPTION OF THE TEMPERATURES ON THE CONTROL UNIT

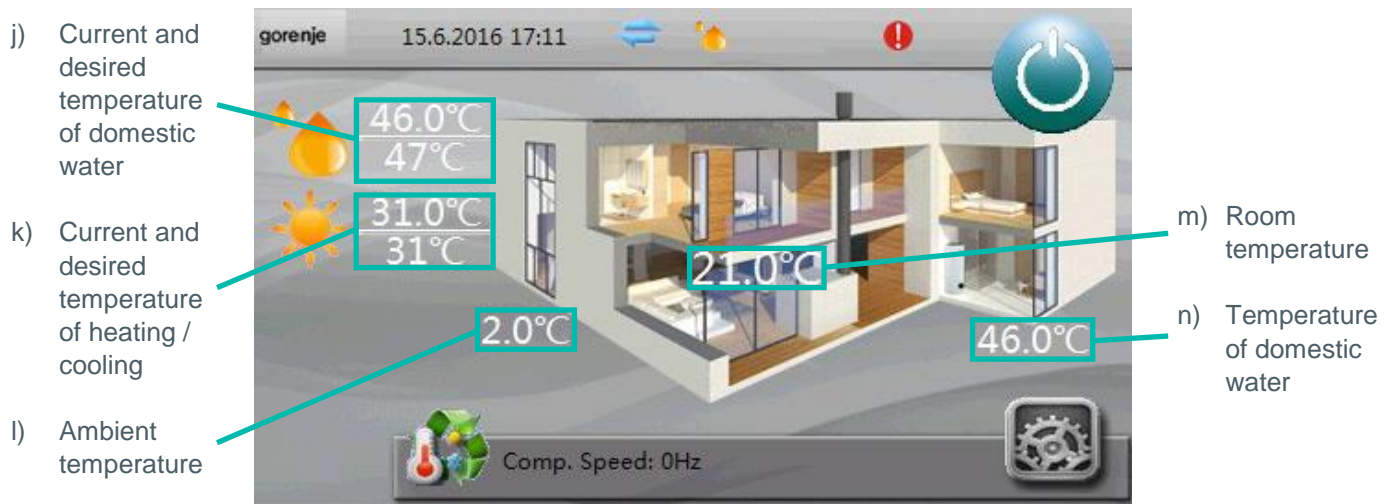

### j) Current and desired temperature of domestic water

Two temperatures are displayed:

**Above – Current temperature**

**Below – Desired temperature**

### k) Current and desired temperature of heating/cooling

Two temperatures are displayed:

**Above – Current temperature**

**Below – Desired temperature** (calculated from the heating curve or desired temperature).

### l) Ambient temperature

The current ambient temperature is displayed.

### m) Room temperature

The current room temperature is displayed.

The temperature sensor does not control the operation of the heat pump! It can be used for the “Room temp. Effect on the Heating Curve” feature, which automatically reduces or increases the heating curve by a few percent.

### n) Temperature of domestic water

The current temperature of domestic water is displayed.



## 5 QUICK SETTINGS

### 5.1 PARALLEL MOVE OF THE HEATING CURVE

What is a parallel move of the heating curve?

At start-up, the heating curve is adjusted according to the heating system (Floor heating system, Radiators, Fan coils) and desired room temperature.

The setting can be changed from the Main screen, but only the complete move of the heating curve and not each reference point separately. The heating curve can be raised or lowered for 3 °C (-3 to +3).

By raising the heating curve for 2-3 °C would mean an increase of the room temperature for approx. 1 °C.

The graph below shows a parallel move of the heating curve – lowering of the heating curve for 2°C

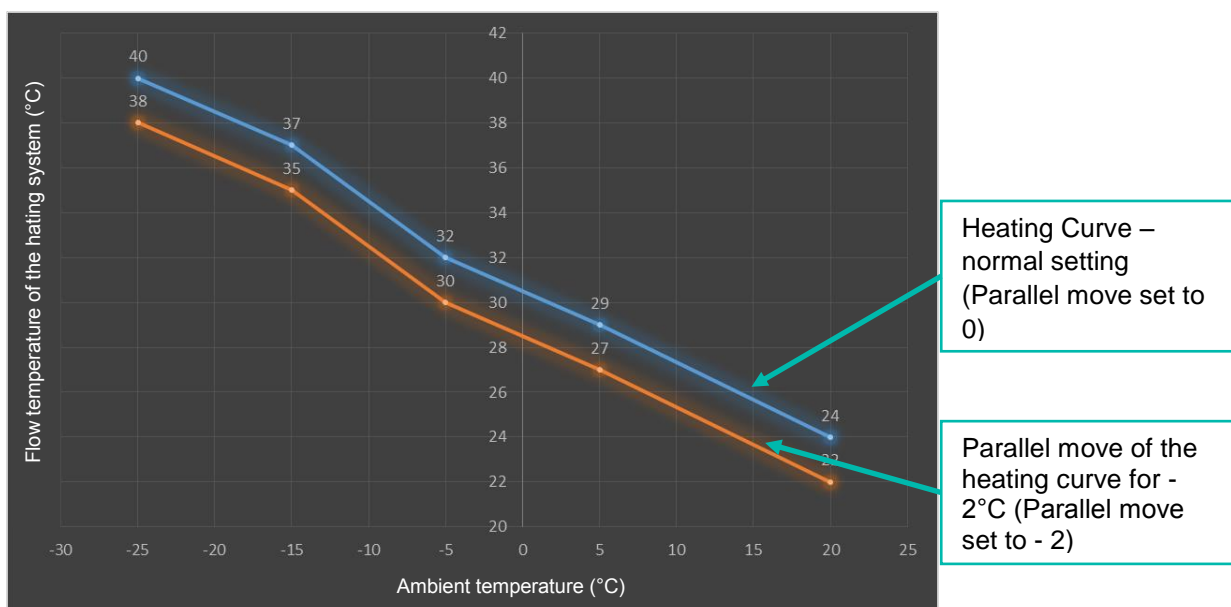

#### 5.1.1 SETTING THE PARALLEL MOVE OF THE HEATING CURVE – HEATING CIRCUIT

1

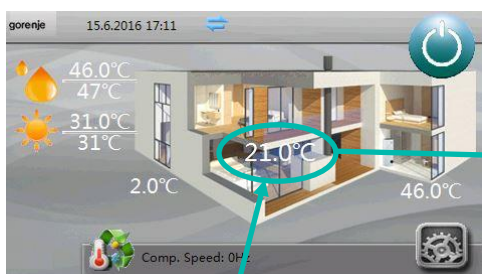

By pressing on the Room temperature display, an additional window appears.

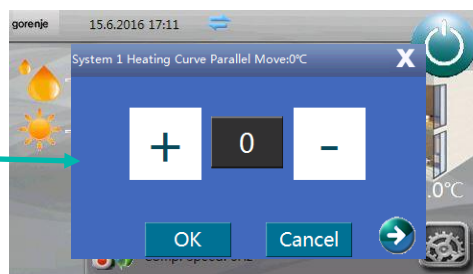

With buttons “+” or “-” the heating curve can be changed for the desired value. Confirm the setting with button “OK”.

## 5.1.2 SETTING THE PARALLEL MOVE OF THE HEATING CURVE – HEATING CURVE 2

PARALLEL MOVE OF THE HEATING CURVE 2 IS AVAILABLE ONLY WHEN USING TWO HEATING CIRCUITS!

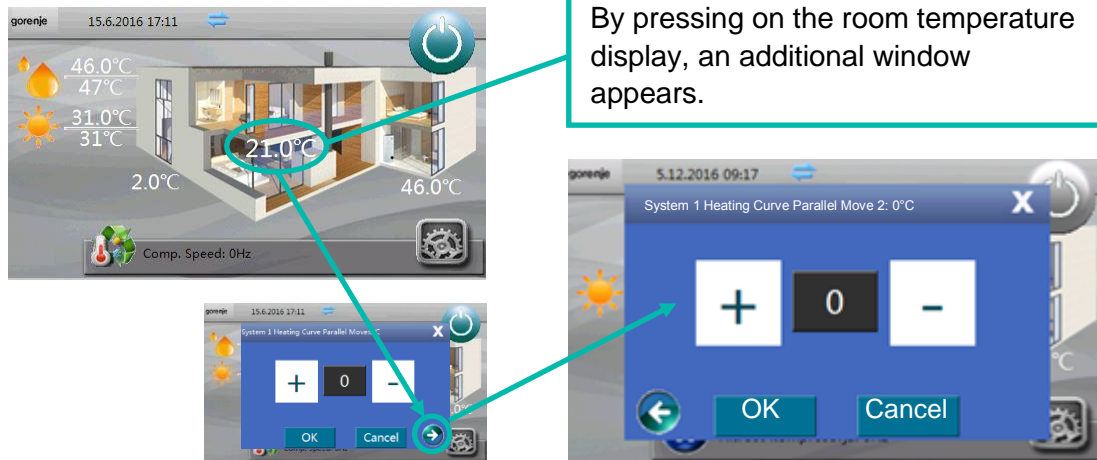

First the window for parallel move of the first heating circuit appears. To access the setting of the parallel move for the second heating circuit press . Second page appears with the setting for the second heating circuit. With buttons “+” or “-” the heating curve can be changed for the desired value. Confirm the setting with button “OK”.

## 5.1.3 SETTING THE DHW TEMPERATURE

By pressing on the DHW temperature, an additional window appears.

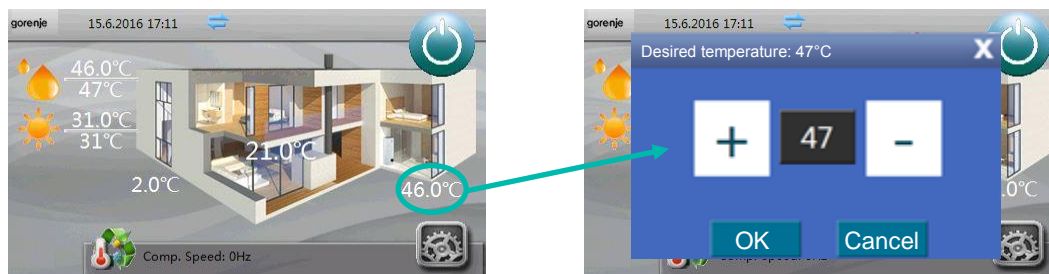

With buttons “+” or “-” the DHW set temperature can be changed for the desired value. Confirm the setting with button “OK”.

Domestic hot water settings depend on the user’s habits.

The recommended setting for domestic hot water is between 47 °C and 50 °C.

Traditional systems (boilers) use smaller domestic water storage tanks, so the temperature must be significantly higher than in a heat pump system, which causes higher costs of domestic hot water preparation!

In principle, a heat pump system is planned to store 50 litres of water per person. This means that a family of four needs a minimum of 200 litres of hot water per day.

### **Note:**

Mixing of cold and warm water in a mixing tap differs according to the systems of how domestic water is heated.

If the traditional domestic water heating system is used, less hot water is mixed with cold than in a heat pump system.

In a heat pump system, a larger quantity of hot water is mixed with cold water, as the volume is larger and the temperature is lower (contributing to lower costs) than in the traditional system, where the water volume is 2-3 times smaller.

## 5.2 SETTING THE FIXED TEMPERATURE OF HEATING CIRCUIT

This quick setting is available only when one or both heating circuits are used without heating curves.

### 5.2.1 SETTING THE FIXED TEMPERATURE FOR THE FIRST HEATING CIRCUIT

By pressing on the temperature below the line, beside the sun symbol, an additional window will appear.

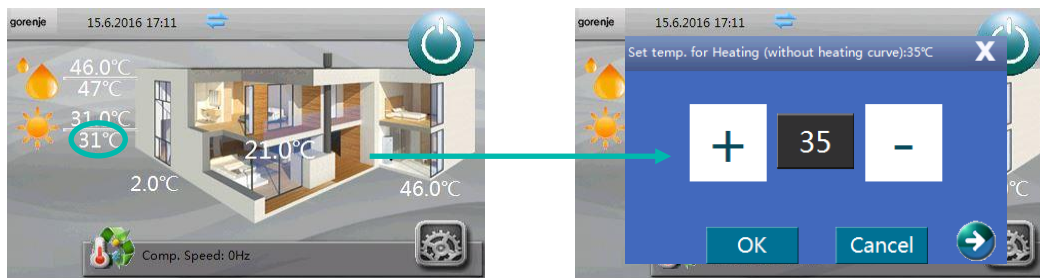

With buttons "+" or "-" the fixed temperature for the first heating circuit can be changed for the desired value. Confirm the setting with button "OK".

### 5.2.2 SETTING THE FIXED TEMPERATURE FOR THE SECOND HEATING CIRCUIT

By pressing on the temperature below the line, beside the sun symbol, an additional window will appear. Press the arrow in the down right corner to access the setting for the second heating circuit.

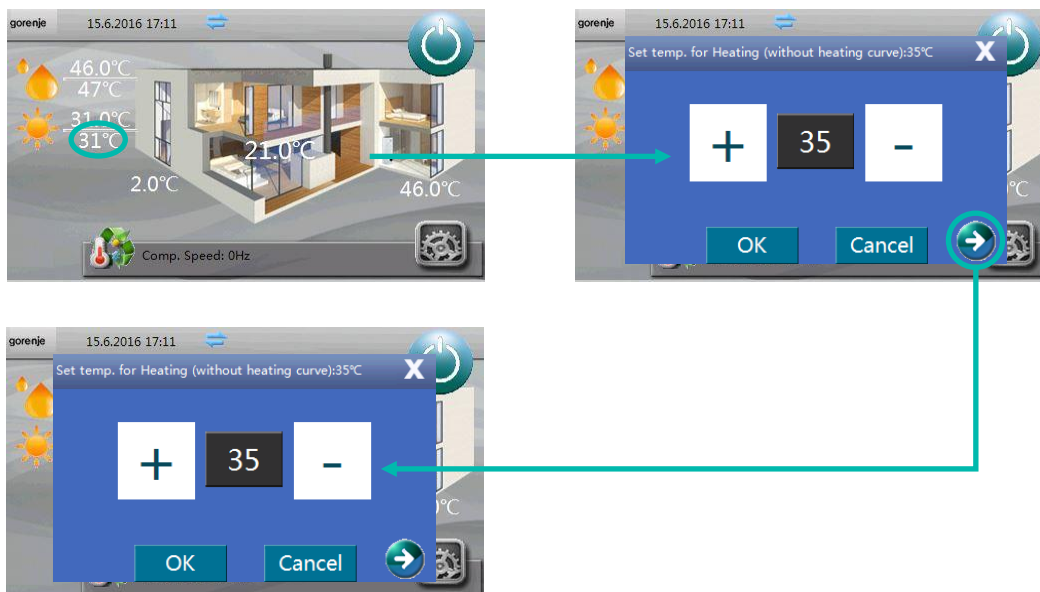

With buttons "+" or "-" the fixed temperature for the second heating circuit can be changed for the desired value. Confirm the setting with button "OK".

## 6 USER INTERFACE



### 6.1 ARRANGMENT OF MENUS

The control unit has two levels of menus. The first page of the menus is intended for the end user, and the second page is for the authorized service person or for install settings with some excluded exceptions.



### 6.2 MENU ACCESS

By pressing  you can access the menus with settings for the end user, as well as the service settings (see image below)!

Service settings are protected by a service code. The end user is not allowed access to these settings. The user can view the settings but is not allowed to change them!



## 6.3 SETTINGS

### Heating

The heat pump enables two heating circuits, meaning that it can control two different temperature modes. *Heating/cooling circuit 1 and Heating/cooling circuit 2*

When only one heating circuit is in use, the heating settings are defined in the menu "Heating/cooling circuit 1"!

#### 6.3.1 Heating/Cooling Circuit 1

The screenshots show the following settings across five pages:

- Page 1/5:**
  - Heating/Cooling Stops Based on Water  $\Delta T$ : 2°C
  - Heating/Cooling Restarts Based on Water  $\Delta T$ : 2°C
  - $\Delta T$  Compressor Speed-reduction: 2°C
  - Set temp. for Cooling: 24°C
  - Heating Curve:
- Page 2/5:**
  - Ambient Temp. 1: -25°C
  - Ambient Temp. 2: -15°C
  - Ambient Temp. 3: -5°C
  - Ambient Temp. 4: 5°C
  - Ambient Temp. 5: 20°C
- Page 3/5:**
  - Water Temp. A / Ambient Temp. 1: 40°C
  - Water Temp. B / Ambient Temp. 2: 37°C
  - Water Temp. C / Ambient Temp. 3: 33°C
  - Water Temp. D / Ambient Temp. 4: 29°C
  - Water Temp. E / Ambient Temp. 5: 25°C
- Page 4/5:**
  - Room temp. effect on Heating Curve:
  - Ideal Room temp. in Heating: 21°C
  - Ideal Room temp. in Cooling: 24°C
  - Set temp. for Heating (without heating curve): 35°C
  - Low Temperature Limit: 23°C
- Page 5/5:**
  - High Temperature Limit: 40°C
  - Mixing Valve:

##### 6.3.1.1 Heating/Cooling Stops Based on Water $\Delta T$

Temperature setting that allows overheating of the heating system for the set value.

The recommended setting is 2 °C! This enables efficient operation of the Inverter technology and brings the highest savings.

Please note, that we allow the Heat Pump to overheat the system, to maintain a low working speed and to avoid a frequent stopping and starting of the compressor.

### **6.3.1.2 Heating/Cooling Restarts Based on $\Delta T$**

The compressor restarts based on the set values of heating/cooling circuits. The recommended value is 2 °C. This enables efficient operation of the Inverter technology and brings the highest savings.

### **6.3.1.3 $\Delta T$ Compressor Speed Reduction**

This setting tells the system when will the compressor start lowering its working speed. The recommended value is 2 °C. This enables efficient operation of the Inverter technology and brings the highest savings.

#### **For example:**

If the set/calculated temperature is 30°C and the “ $\Delta T$  COMPRESSOR SPEED REDUCTION” is set to 2°C, the compressor will work at its max working speed (check chapter “Max Compressor Working Speed”) till it reaches 28°C. At a 28,1°C and above the compressor speed will start to decrease towards the lowest working speed of the compressor.

### **6.3.1.4 Set temp. For cooling**

Setting the desired cooling water temperature of the first cooling circuit is set (the second circuit is set in the menu “Heating/Cooling Circuit 2”).

### **6.3.1.5 Heating Curve**

The heating curve mode is based on the condition that the lower the ambient temperature is, the higher the water temperature for the heating of facility is. This heating curve mode can help the heat pump to achieve a higher COP (efficiency rate) and increase the feeling of comfort in the house.

As the level of home insulation and people’s feeling of cold can differ, the factory set curve may not be appropriate for everybody. The heating curve may be set according to customers needs.

The basic setting of the heating curve is made upon the first start-up of the heat pump. The start-up must be performed by an authorized service person!

The basic setting is always adjusted according to the system that is installed (underfloor heating, radiators, convectors (Fan Coil)). To determine the basic heating curve, we also need to take into account the insulation of the facility!

The heat pump enables two heating circuits with different heating curves.

**Tsh – Space heating temp.; T(Ta) – Ambient temp.**

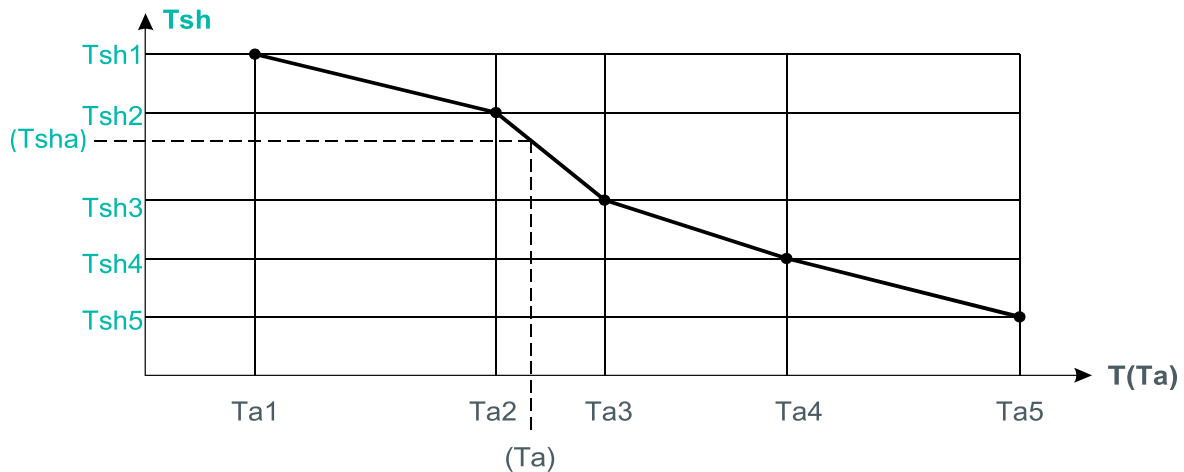

Page:2/5

Ta1	Ambient Temp. 1	-25°C
Ta2	Ambient Temp. 2	-15°C
Ta3	Ambient Temp. 3	-5°C
Ta4	Ambient Temp. 4	5°C
Ta5	Ambient Temp. 5	20°C

Page:3/5

Tsh1	Water Temp. A /Ambient Temp. 1	40°C
Tsh2	Water Temp. B/Ambient Temp. 2	37°C
Tsh3	Water Temp. C/Ambient Temp. 3	33°C
Tsh4	Water Temp. D/Ambient Temp. 4	29°C
Tsh5	Water Temp. E/Ambient Temp. 5	25°C

**NOTE:**

It is recommended to reset only the space heating water temperatures (figure above on the right). Resetting ambient temperatures for the heating curve affects both heating circuits.

**6.3.1.6 SETTING THE HEATING CURVE FOR THE FIRST HEATING CIRCUIT**



Heating curve is set on page 3 of the “Heating/Cooling Circuit 1” menu!

PAGE 3

Water Temp. A /Ambient Temp. 1	40°C
Water Temp. B/Ambient Temp. 2	37°C
Water Temp. C/Ambient Temp. 3	33°C
Water Temp. D/Ambient Temp. 4	29°C
Water Temp. E/Ambient Temp. 5	25°C

EXAMPLE

Water Temp. A /Ambient Temp. 1	38°C
Water Temp. B/Ambient Temp. 2	35°C
Water Temp. C/Ambient Temp. 3	31°C
Water Temp. D/Ambient Temp. 4	27°C
Water Temp. E/Ambient Temp. 5	24°C

**Example:**

The customer wants the room temperature to be 21 °C, but the heat pump heats the rooms to 22 °C. In this case the heating curve must be lowered. On page 3, all temperatures need to be lowered by 2-3 °C, which means that the room temperature will be lower by 1 °C. If the room temperature is lower than the desired temperature, the temperature values must be increased.

### **6.3.1.7 Room temp. effect on Heating Curve**

When the temperature sensor “TR” is mounted in the living area, this function can make small corrections of the heating curve, depending on the set “Ideal Room Temp. in Heating”.

#### **Note:**

This feature does not mean temperature control by room temperature, but only a correction of the heating curve!

If this feature is on and the temperature in the room (where the TR room temperature sensor is located) still exceeds the set ideal value, the heating curve settings should be reset!

### **6.3.1.8 Ideal Room temp. in Heating**

Relates to parameter (6.3.1.6).

The setting is active only when the feature “Room Temp. Effect on Heating Curve” is enabled.

### **6.3.1.9 Ideal Room temp. in Cooling**

Relates to parameter (6.3.1.6).

The setting is active only when the feature “Room Temp. Effect on Heating Curve” is on

### **6.3.1.10 Set Temperature for heating – without heating curve**

Set temperature for the heating water system – without heating curve.

When the heating curve is disabled, the heat pump operates with fixed system heating water temperature.

Weather-related control of the heating circuit is disabled, which can lead to higher heating costs!

#### **NOTE:**

The parameters in grey are protected by a service code!

### **6.3.1.11 Low Temperature Limit**

This is for setting the lowest possible temperature that the end customer can set, without accessing the service level. This setting applies for the heating mode and cooling mode.

### **6.3.1.12 High Temperature Limit**

This is for setting the highest possible temperature that the end customer can set, without accessing the service level. This setting applies for the heating mode only.

Default setting is 40°C, meaning if a system with higher desired temperatures is used (radiators, Fan-coils...) the Limitation must be increased.

### **6.3.1.13 Mixing Valve**

Enabling or Disabling the Mixing Valve for the first Heating/Cooling Circuit (Heating/Cooling Circuit 1).

A check in a box means that the Heating/Cooling Circuit 1 uses a Mixing Valve for the Circuit.

Please note that if the Mixing Valve is Enabled a temperature sensor (TV1) must be added after the Mixing Valve.



## 6.3.2 Heating/Cooling circuit 2

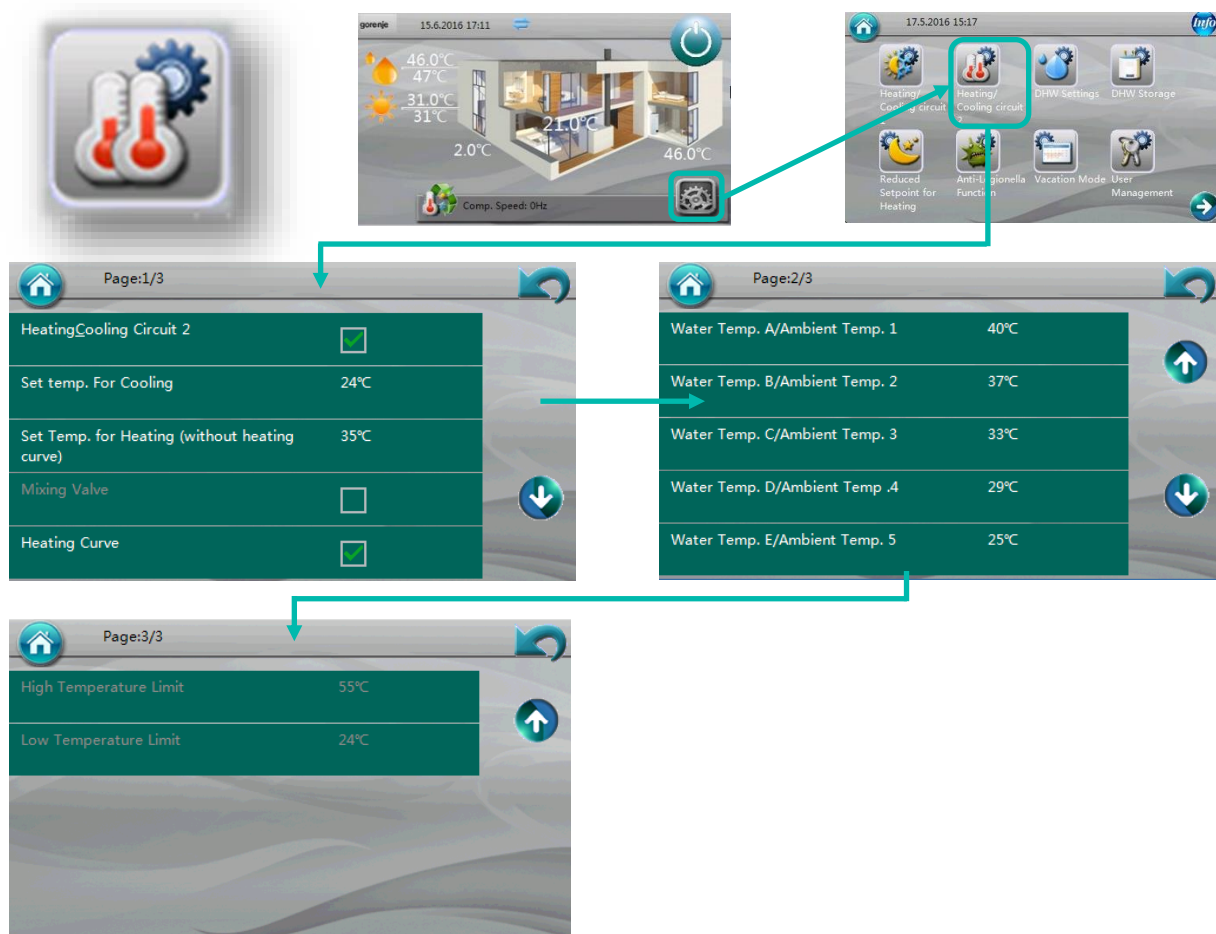

### 6.3.2.1 Heating/cooling Circuit 2

A check in a box means that the heating/cooling circuit 2 is on.

### 6.3.2.2 Set temp. for Cooling

Setting the desired space cooling water temperature in Cooling Circuit 2.  
The desired temperature of Cooling Circuit 2 is set.

### 6.3.2.3 Set Temp. For Heating – without heating curve

Set temperature of space heating water– without heating curve.  
When the heating curve is off, the heat pump operates with fixed space heating water temperature.  
Weather-related control of the heating circuit is off, which can lead to higher heating costs!

### 6.3.2.4 Mixing Valve

Enabling or Disabling the Mixing Valve for the second Heating/Cooling Circuit (Heating/Cooling Circuit 2).

A check in a box means that the Heating/Cooling Circuit 2 uses a Mixing Valve for the Circuit.

If the Mixing Valve is Enabled, a temperature sensor (TV2) must be added after the Mixing Valve.

**NOTE:**

If the second heating circuit is active and the room thermostat is not used, a wire must be placed between TH and COM. If a wire is not placed between TH and COM, the heat pump will heat the buffer tank according to the lower temperature demand.

**6.3.2.5 Heating Curve**

The heating curve mode is based on the condition that the lower the ambient temperature is, the higher the water temperature for the heating of facility is. This heating curve mode can help the heat pump to achieve a higher COP (efficiency rate) and increase the feeling of comfort in the house.

As the level of home insulation and people’s feeling of cold can differ, the factory set curve may not be appropriate for everybody. The heating curve may be set according to customers needs.

The basic setting of the heating curve is made upon the first start-up of the heat pump. The start-up must be performed by an authorized service person!

The basic setting is always adjusted according to the system that is installed (underfloor heating, radiators, convectors (Fan Coil)). To determine the basic heating curve, we also need to take into account the insulation of the facility!

The heat pump enables two heating circuits with different heating curves.

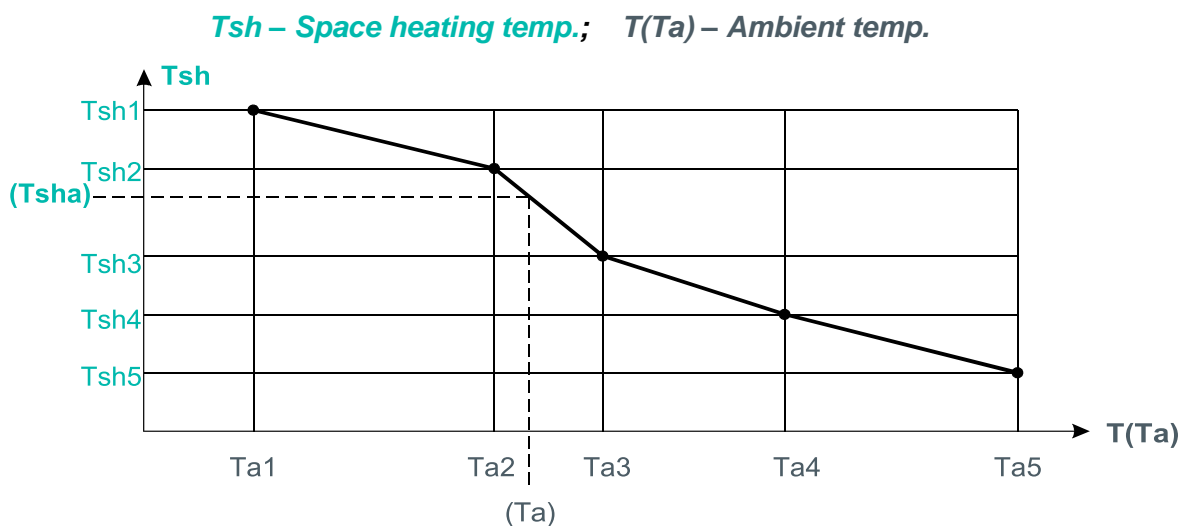

	Ambient Temp. 1	-25°C
Ta1	Ambient Temp. 2	-15°C
Ta2	Ambient Temp. 3	-5°C
Ta3	Ambient Temp. 4	5°C
Ta4	Ambient Temp. 5	20°C
Ta5		

	Water Temp. A / Ambient Temp. 1	40°C
Tsh1	Water Temp. B / Ambient Temp. 2	37°C
Tsh2	Water Temp. C / Ambient Temp. 3	33°C
Tsh3	Water Temp. D / Ambient Temp. 4	29°C
Tsh4	Water Temp. E / Ambient Temp. 5	25°C
Tsh5		

**NOTE:**

It is recommended to reset only the space heating water temperatures (figure above on the right). Resetting ambient temperatures for the heating curve affects both heating circuits.

### 6.3.2.6 SETTING THE HEATING CURVE FOR THE SECOND HEATING CIRCUIT

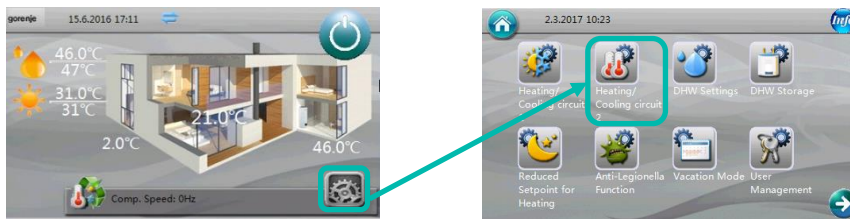

Heating curve is set on page 2 of the “Heating/Cooling Circuit 2” menu!

Water Temp. A/Ambient Temp. 1	55°C	EXAMPLE	Water Temp. A/Ambient Temp. 1	52°C
Water Temp. B/Ambient Temp. 2	50°C		Water Temp. B/Ambient Temp. 2	48°C
Water Temp. C/Ambient Temp. 3	45°C		Water Temp. C/Ambient Temp. 3	43°C
Water Temp. D/Ambient Temp. 4	40°C		Water Temp. D/Ambient Temp. 4	38°C
Water Temp. E/Ambient Temp. 5	35°C		Water Temp. E/Ambient Temp. 5	33°C

**Example:**

The customer wants the room temperature to be 21 °C, but the heat pump heats the rooms to 22 °C. In this case the heating curve must be lowered. On page 3, all temperatures need to be lowered by 2-3 °C, which means that the room temperature will be lower by 1 °C. If the room temperature is lower than the desired temperature, the temperature values must be increased.

### 6.4 DHW SETTINGS

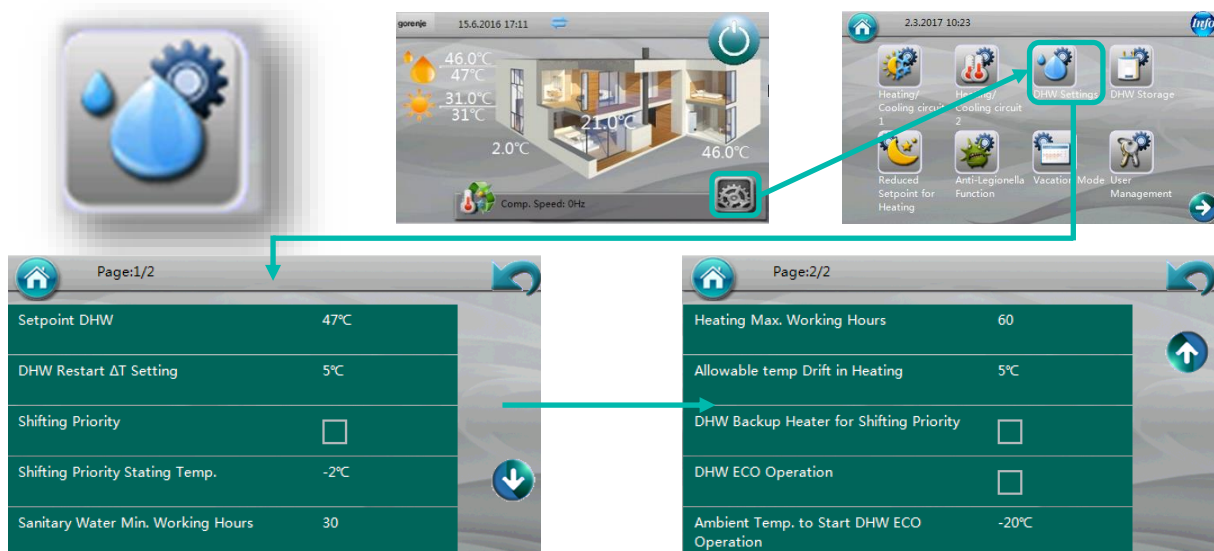

#### **6.4.1.1 Setpoint DHW**

Setting of the desired temperature for domestic water.

#### **6.4.1.2 DHW Restart $\Delta T$ Setting**

Domestic hot water restart setting.

##### **Example:**

Desired temperature of domestic water is 47 °C, and the domestic hot water restart  $\Delta T$  setting is 5 °C. (47–5=42)

This means that the heat pump will restart the heating of domestic water when the temperature drops below 42 °C!

Recommended domestic hot water restart  $\Delta T$  setting is 5 °C!

#### **6.4.1.3 Shifting Priority**

The heat pump has absolute priority for the preparation of domestic hot water. With this feature, the priority adjusts to the heat losses when the ambient temperature reaches a certain point.

This feature is used in new buildings that still lack insulation and that will be without insulation for at least one heating season.

##### **6.4.1.3.1 Enabling or Disabling the Shifting Priority function:**

**Disabled** (default setting) – the Heat Pump will switch to Heating mode only when the desired DHW temperature is reached.

**Enabled** – the Heat Pump will decide based on the temperatures of the heating system if it should switch to heating although the DHW set temperature is not reached yet.

##### **For example:**

Set temperature for DHW is 47°C and the Heat Pump is currently working in DHW mode. The actual DHW temperature is 44°C, meaning it still has to heat up the DHW for another 3°C, before it can switch to heating mode (heating the House). In that moment, the Unit sees that the temperature of the Heating water for the heating system is dropping for a certain value, meaning it is a high risk of undercooling the house. It switches to Heating mode to provide heat to the house. When the temperature is in safe level, or the max set time for heating is exceeded, the Heat Pump switches back to DHW mode to heat up the DHW to the desired value, before it switches back to Heating mode.

##### **6.4.1.3.2 Shifting Priority Starting Temperature**

Only valid if Shifting Priority enabled!

Setting the Ambient temperature to activate the Shifting Priority Function.

If the Shifting Priority Function is enabled, it will not be active before the Ambient temperature falls below a certain value (Shifting Priority Starting temperature).

##### **6.4.1.4 Sanitary Water Min. Working Hours**

Only valid if Shifting Priority enabled!

This setting is set in Minutes!

The Heat Pump will try to heat up the DHW for a minimum time before it switches to Heating, even if all other conditions for Shifting Priority are met.

##### **6.4.1.5 Heating Max. Working Hours**

Only valid if Shifting Priority enabled!

This setting is set in Minutes!

When the Heat Pump switches to Heating mode in Shifting priority mode, it will allow the unit to stay in Heating mode only for a certain time, before it switches back to heat up the DHW.

#### 6.4.1.6 Allowable temp. Drift in Heating

Only valid if Shifting Priority enabled!

Setting for the max. Temperature drift in heating system during DHW heating mode. Only when this value is exceeded, the Unit will switch to heating.

#### 6.4.1.7 DHW Backup Heater for Shifting Priority

Only valid if Shifting Priority enabled!

**Disabled** – Backup heater will work only according to the normal back-up stings.

**Enabled** – Backup Heater will help to faster heat up the DHW.

#### 6.4.1.8 DHW ECO Operation

Enable or Disable this function.

**Disabled** (default setting) – normal operation of DHW working mode

**Enabled** – the compressor speed never exceeds 50% of the compressor working speed, which is determent by the ambient temperature (see chapter “Compressor Speed”).

#### **NOTE:**

In normal operation (DHW ECO Operation – Disabled), the compressor speed is limited by the Ambient temperature, meaning that the compressor speed will decrease when ambient temperature is Increasing.

#### 6.4.1.9 Ambient Temp. to Start DHW ECO Operation

Setting the Ambient temperature when the DHW ECO Operation function will be active.

Please note, that DHW ECO Operation will be active if the Ambient temperature is higher than this setting!

## 6.5 DHW STORAGE



### 6.5.1 Sanitary Hot Water Storage Function

Feature on/off.

A check in the box means that the feature is on.

This feature enables water preparation at a certain time and day. It is set for each day of the week individually.

### 6.5.2 Sanitary Hot Water Storage Timer



Setting domestic water heater timer!

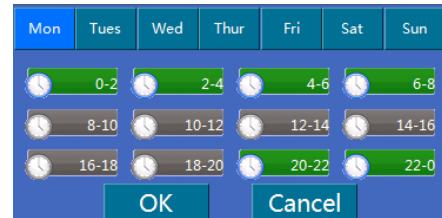
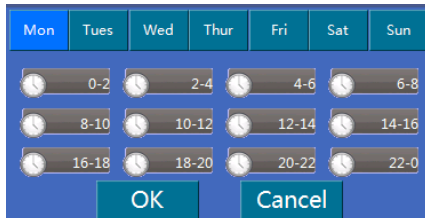

If the fields are green, domestic water heating is on.

If the fields are grey, it means the heat pump is not heating domestic water.

### 6.5.3 Reheating Function

Feature on/off.

A check in the box means that the feature is on.

The feature enables the setting of a second temperature mode for domestic water heating. This means that it enables two different temperatures of domestic water at various times in an individual day of the week.

Setting of a second temperature of domestic hot water corresponds to the parameter “Reheating Set Temp.”.

### 6.5.4 Reheating Function Timer

Setting the second timer for the heating of domestic hot water!

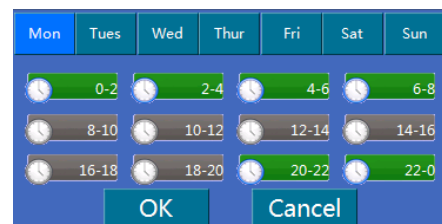
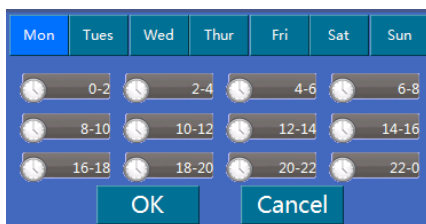

If the fields are green, domestic water heating is on.

If the fields are grey, it means the heat pump is not heating domestic water.

### 6.5.5 Reheating Set Temp.

Setting the desired temperature for the second mode of heating of domestic water.

This temperature will be the default temperature for domestic water heating in the “double mode”.

The temperature can be lower or higher than the primary setting of the desired domestic hot water temp.!

**Note:**

If timers overlap, the heat pump will take into account the higher level of desired domestic water temperature!

### 6.5.6 Reheating Restart $\Delta T$ Setting

For the second temperature mode for heating domestic water, this parameter is used to set the DHW restart. The recommended setting is 5 °C.

**Example:**

Desired domestic hot water temperature is 45 °C, and the DHW restart setting is 5 °C. (45–5=40).

Heat pump will start reheating domestic water once it drops below 40 °C.

## 6.6 REDUCED SETPOINT

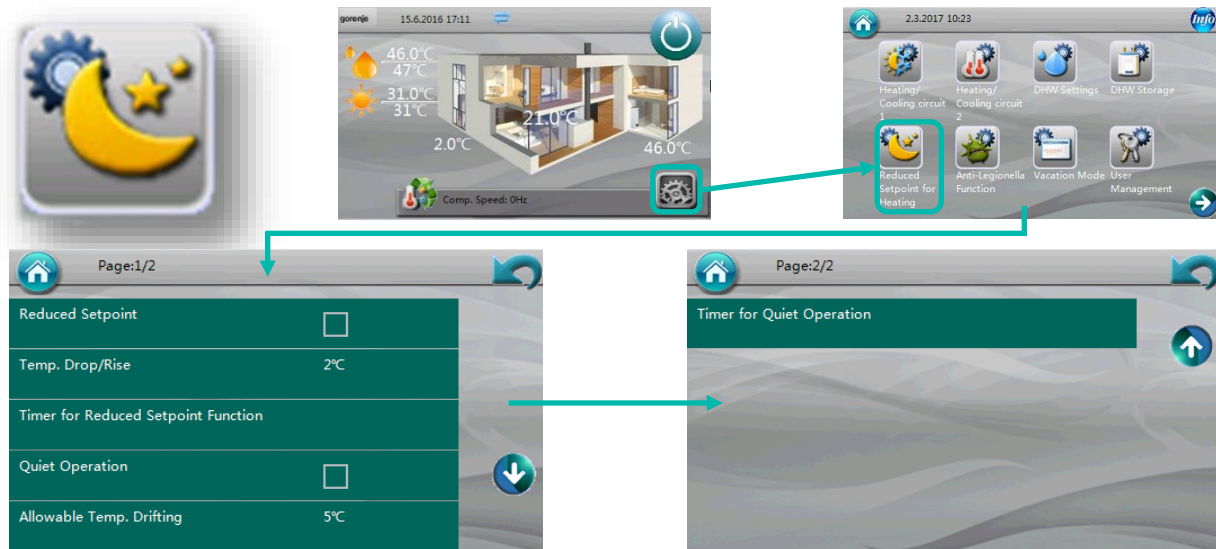

### 6.6.1 Reduced Setpoint

Feature on/off.

A check in the box means that the feature is on.

The feature lowers water temperature by the set value for both heating circuits in the set time. The main purpose is to lower room temperature at night.

### 6.6.2 Temp. Drop/Rise

The space heating water temperature drop/rise is set for both heating circuits.

### 6.6.3 Timer for Reduced Setpoint Function

Timer for feature activation is set!

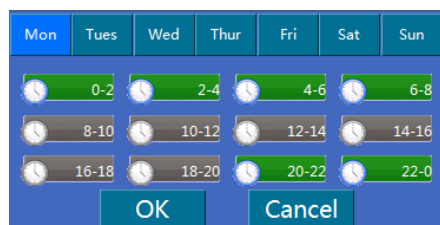

If the fields are green, domestic water heating is on.

If the fields are grey, it means the heat pump is not heating domestic water.

### 6.6.4 Quiet Operation

Feature on/off.

A check in the box means that the feature is on.

Quiet operation means that the heat pump tries to operate with the lowest possible rpm of compressor and fans, so that noise is reduced in the night time.

The maximum deviation from the desired space heating water temperature is set.

### 6.6.5 Allowable Temp. Drifting

The maximum allowable space heating water temperature drifting is set for both circuits when the “Quiet operation” feature is on.

### 6.6.6 Timer for Quiet Operation

Timer for the Quiet Operation Feature!

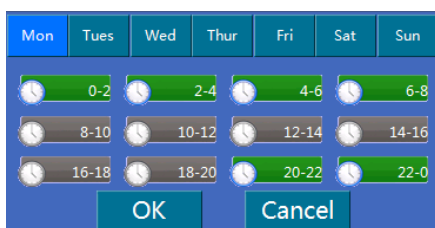

If the fields are green, the feature is on.

If the fields are grey, it means the feature is off – normal operation!

#### **Note:**

If the timers “Reduced Setpoint” and “Quiet Operation” overlap, the heat pump will operate in the quiet mode with an additional temperature drop, as set in the “Temp. Drop/Rise”.

## 6.7 ANTI-LEGIONELLA

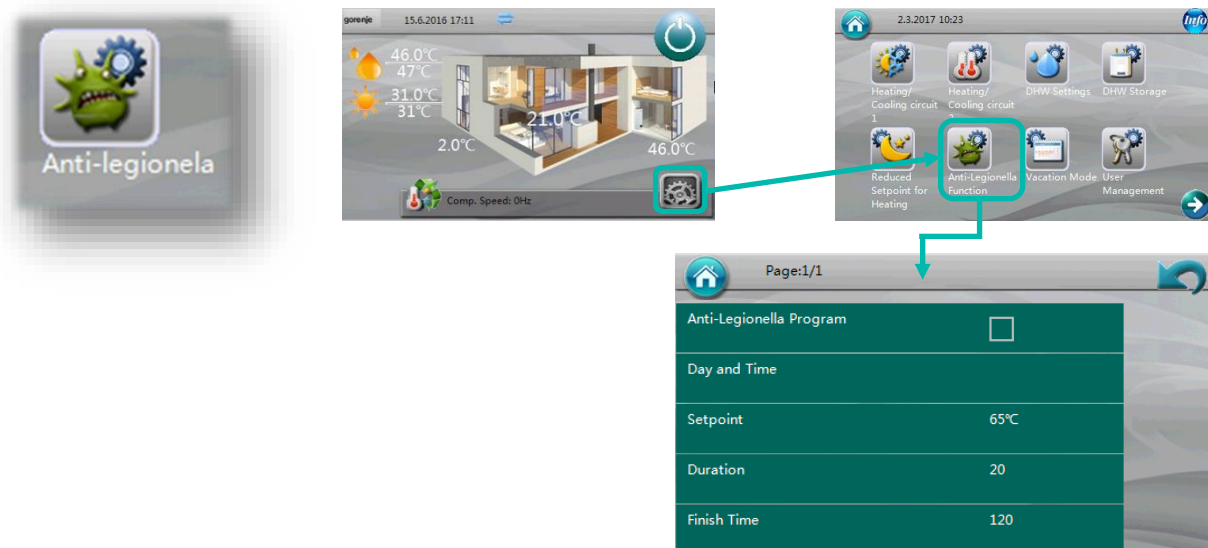



### 6.7.1 Anti – Legionella Program

Feature on/off.

A check in the box means that the feature is on.

For the Anti-legionella feature to operate, an electric heater must be installed in the DHW tank!

### 6.7.2 Day and Time

The day and time for the feature to be switched on is set here.

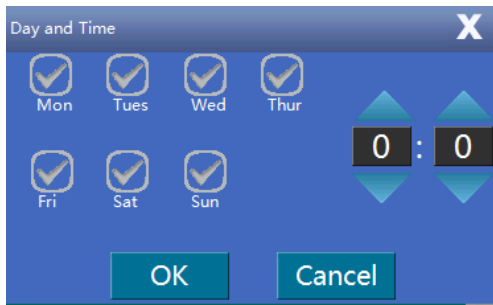

The recommended setting is Monday at 2:00 AM.

### 6.7.3 Setpoint

The desired temperature (setpoint) of the Anti-legionella feature is set here.

### 6.7.4 Duration

Here you can determine how long the heat pump should maintain the desired temperature in the Anti-legionella programme!

### 6.7.5 Finish Time

If the heat pump cannot heat the domestic water in the set time, the programme is terminated and an error message appears on the display.

## 6.8 VACATION MODE

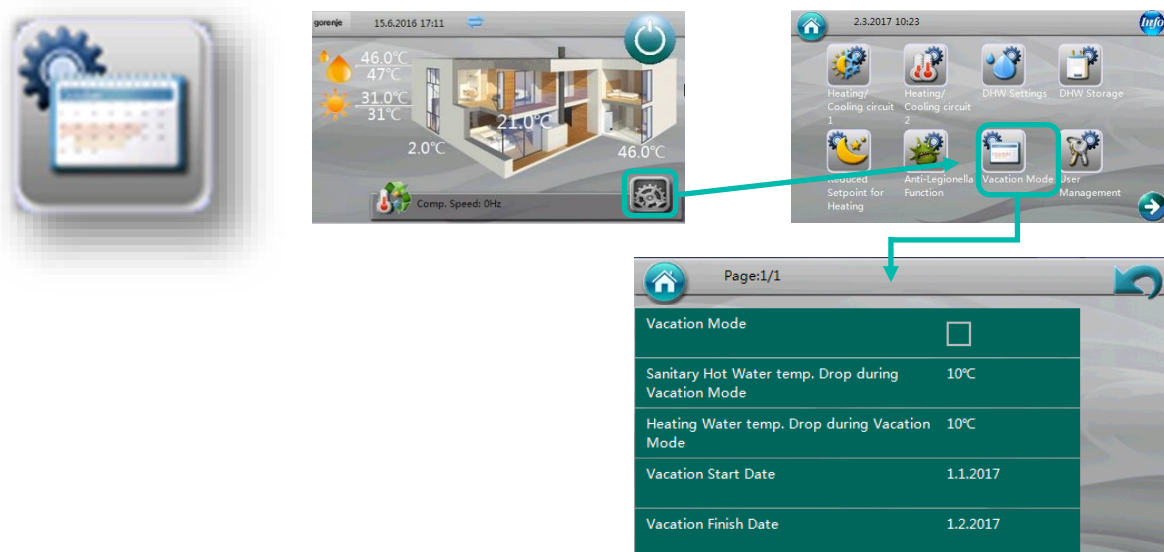

### 6.8.1 Vacation Mode

A check in the box means that the feature is on.

This feature can be used for the time when you are absent and there is no need for heating or hot water. The date of departure (start date) and date of arrival (finish date) is set and the desired heating and water temperature drop for the duration of your vacation.

### 6.8.2 Sanitary Hot Water Temp. Drop during Vacation Mode

Setting domestic hot water temperature drop during the vacation mode.

### 6.8.3 Heating Water Temp. Drop during Vacation Mode

Setting heating water temperature (heating) drop during the vacation mode

### 6.8.4 Vacation Start Date

Setting the start date of vacation.

### 6.8.5 Vacation Finish Date

Setting the finish date of vacation.

## 6.9 USER MANAGEMENT

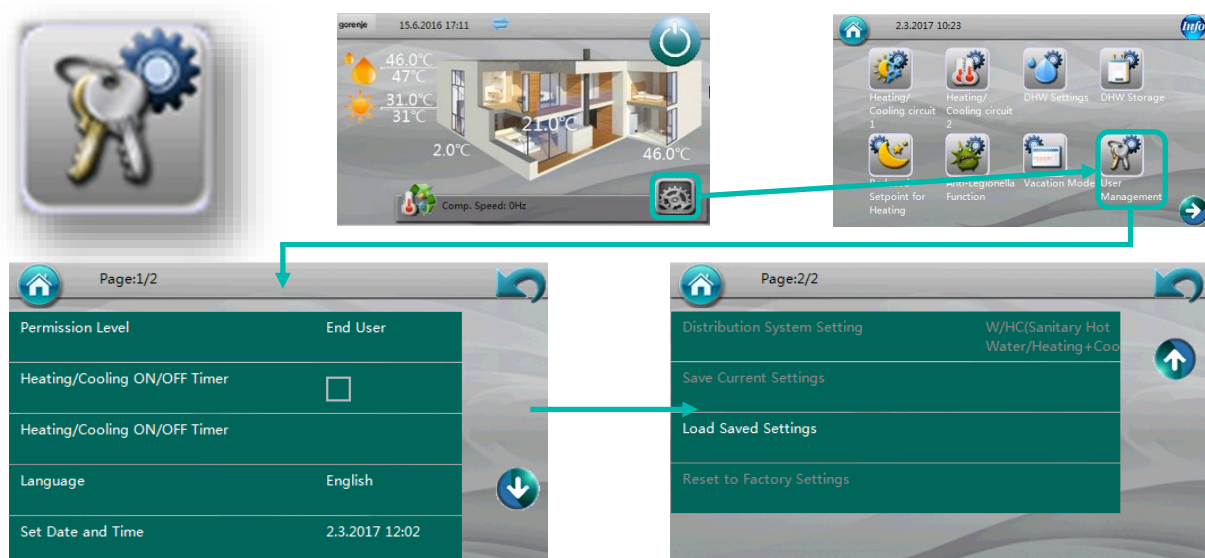

### 6.9.1 Permission Level

Enter the Service Password to enter the Service / Installer level.

Installer code: **87654321**

### 6.9.2 Heating/Cooling ON/OFF timer

**Disabled** (default setting) – Normal operation

**Enabled** – The Heat Pump Will Heat and Cool only according to the setting of a Timer. In the other time, it will be only in Antifreeze protection mode.

Please note, that this has no influence on the DHW mode.

## SETTING THE TIMER:

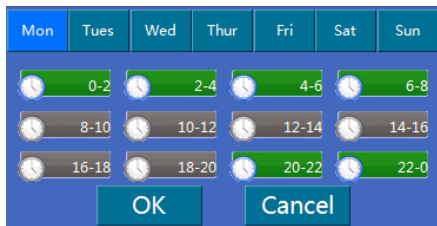

Green fields mean that heating/cooling depending on the ambient temperature is on.

Gray fields mean that heating/cooling depending on the ambient temperature is blocked.

### 6.9.3 Language

Setting the language of the interface.

### 6.9.4 Set Date and Time

Setting the time and date.

### 6.9.5 Distribution System Setting

This is to determine the working logic of the Diverting Valve, which way the water will flow in Heating mode, Cooling mode and DHW mode.

In this Parameter, two options are possible:

**W / HC (Sanitary Hot Water / Heating + Cooling)** – When in DHW mode the Diverting Valve will be in position 1, sending the system water in one direction. When in Heating or in Cooling mode the Diverting Valve will be in position 2, sending the system water in the other direction.

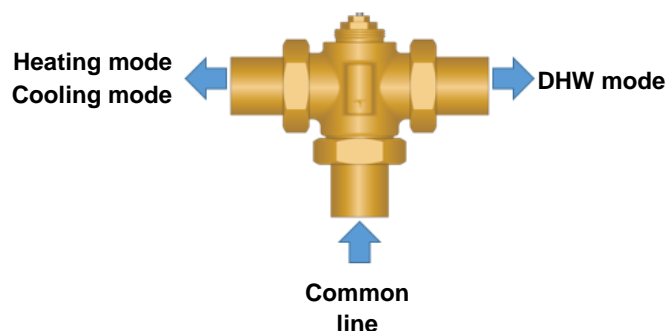

### **WH / C (Hot Water + Heating / Cooling)**

When in DHW mode or Heating mode the Diverting Valve will be in position 1, sending the system water in one direction. When in Heating mode the Diverting Valve will be in position 2, sending the system water in the other direction.

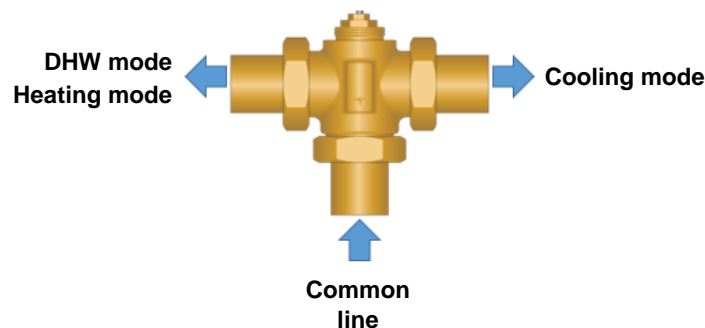

### 6.9.6 Save Current Settings

Saving all the settings at the end of a Start-Up. By saving this setting, the end customer can recall them by pressing "Load Saved Settings", meaning all settings will reset to the settings saved during Start-Up.

### 6.9.7 Load Saved Settings

Reset all settings to “Install Settings”.

All settings are reset to the settings stored during the last intervention by an authorized service person.

### 6.9.8 Switch to Factory Settings

Unit will reset to the factory settings.

## 6.10 MODE SETTINGS

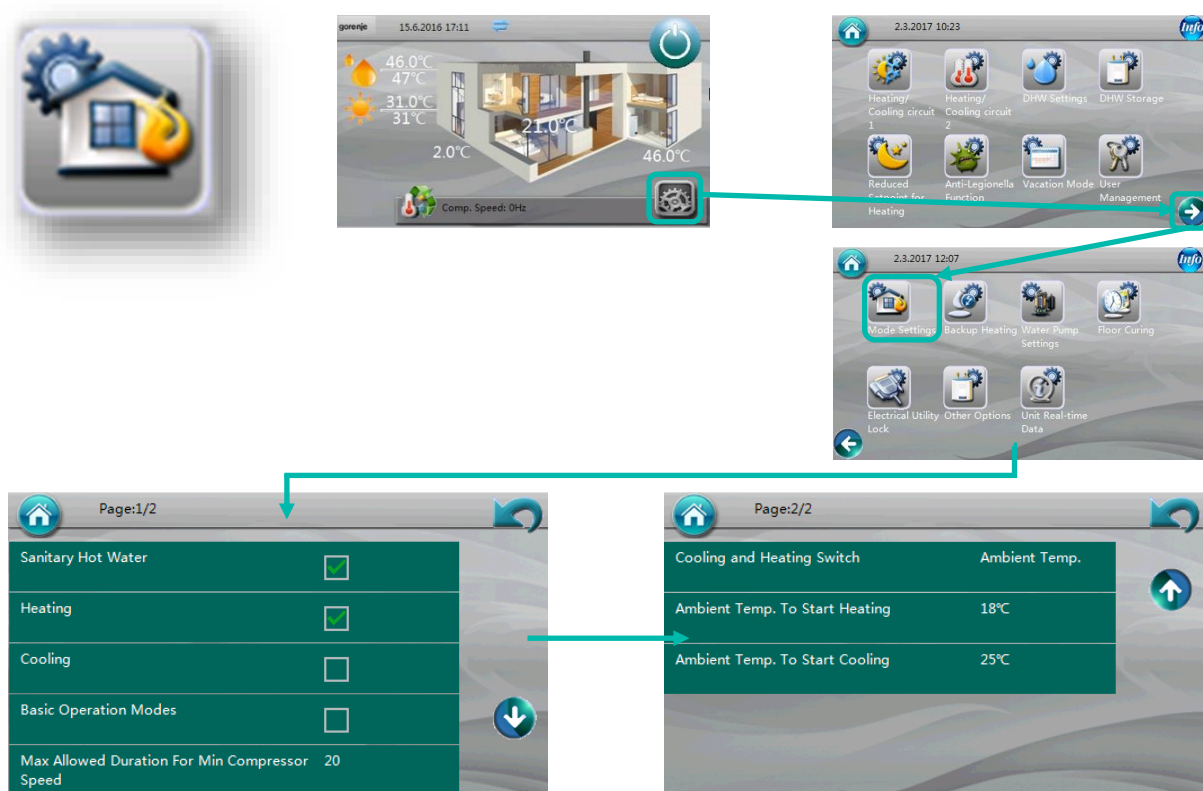

#### 6.10.1 Sanitary Hot Water

**Disabled** (Default setting) – Unit will not work for Sanitary Hot Water (DHW)

**Enabled** - Unit will work for Sanitary Hot Water (DHW)

#### 6.10.2 Heating

**Disabled** – Unit will not work for Heating mode

**Enabled** (Default setting) - Unit will work for Heating mode

#### 6.10.3 Cooling

**Disabled** (Default setting) – Unit will not work for Cooling

**Enabled** - Unit will work for Cooling

#### 6.10.4 Basic Operation Modes

This function is not ready yet!

**DO NOT ENABLE THIS FUNCTION!** It may cause damage to the system and the Unit itself if enabled!

### 6.10.5 Cooling and Heating Switch

Setting how will the Unit decide to start heating or cooling. Default setting is "Ambient temperature".

Please note, that this function does not influence the working of the DHW mode.

Possible settings are:

**OFF** – Unit will not automatically switch to heating or cooling. Only manual switching

**Ambient Temp.** (Default setting) – Unit switches automatically from Heating mode and Cooling mode according to the average ambient temperature. Please refer to parameters 6.9.6 and 6.9.7 for temperature setting.

**External Signal Control** – The Unit will not consider the ambient temperature setting for heating and cooling switch! It will judge based on a signal received to contacts HS - COM (heating signal) and CS – COM (cooling signal).

A potential free signal must be used! No voltage must be present!

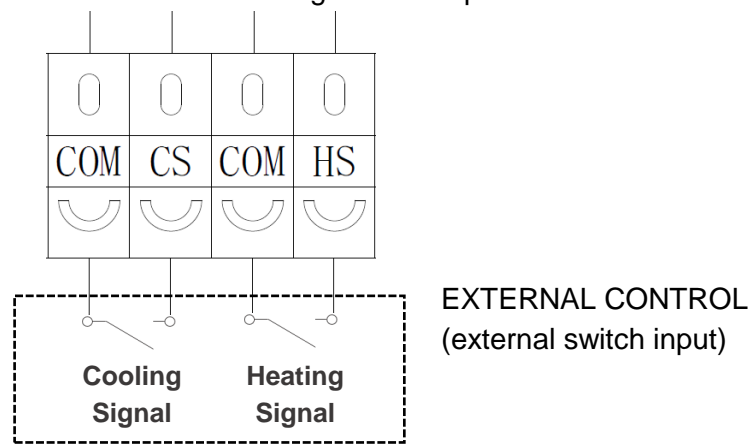

Please note if signal for heating in high ambient temperatures (when heating is not anymore needed) is present, the Heat Pump will run in Heating mode!

#### **External Signal Control + Ambient Temp.**

This setting means, that the Unit will work only for Heating and Cooling with signal (HS – COM or CS – COM), but will take into account the Ambient temperature.

### 6.10.6 Ambient Temp. To Start Heating

Setting the Ambient temperature to start Heating mode.  
Default setting is 18°C.

#### **Example:**

The set temperature to start heating is 18 °C.

The heat pump will heat the facility depending on the set values (heating curve or constant space heating water temperature, depending on the settings), if the ambient temperature drops below 18 °C.

When the ambient temperature rises above 18 °C, the heat pump will automatically stop heating the facility.

It will resume heating when the ambient temperature drops below 18 °C.

#### **Note:**

To prevent too frequent switches between operation and non-operation, the control unit monitors the current temperature and temperature within a certain period and decides based on this whether heating should be activated or blocked.

### 6.10.7 Ambient Temp. To Start Cooling

Setting the activation/start of cooling at a certain ambient temperature.  
The factory setting is 25 °C.

**Example:**

The set temperature to start cooling is 25 °C.

The heat pump will cool the facility depending on the set values if the ambient temperature rises above 25 °C.

When the ambient temperature drops below 25 °C, the heat pump will automatically stop cooling the facility.

It will resume cooling when the ambient temperature rises above 25 °C.

**Note:**

To prevent too frequent switches between operation and non-operation, the control unit monitors the current temperature and temperature within a certain period and decides based on this whether heating should be activated or blocked.

## 6.11 BACKUP HEATING

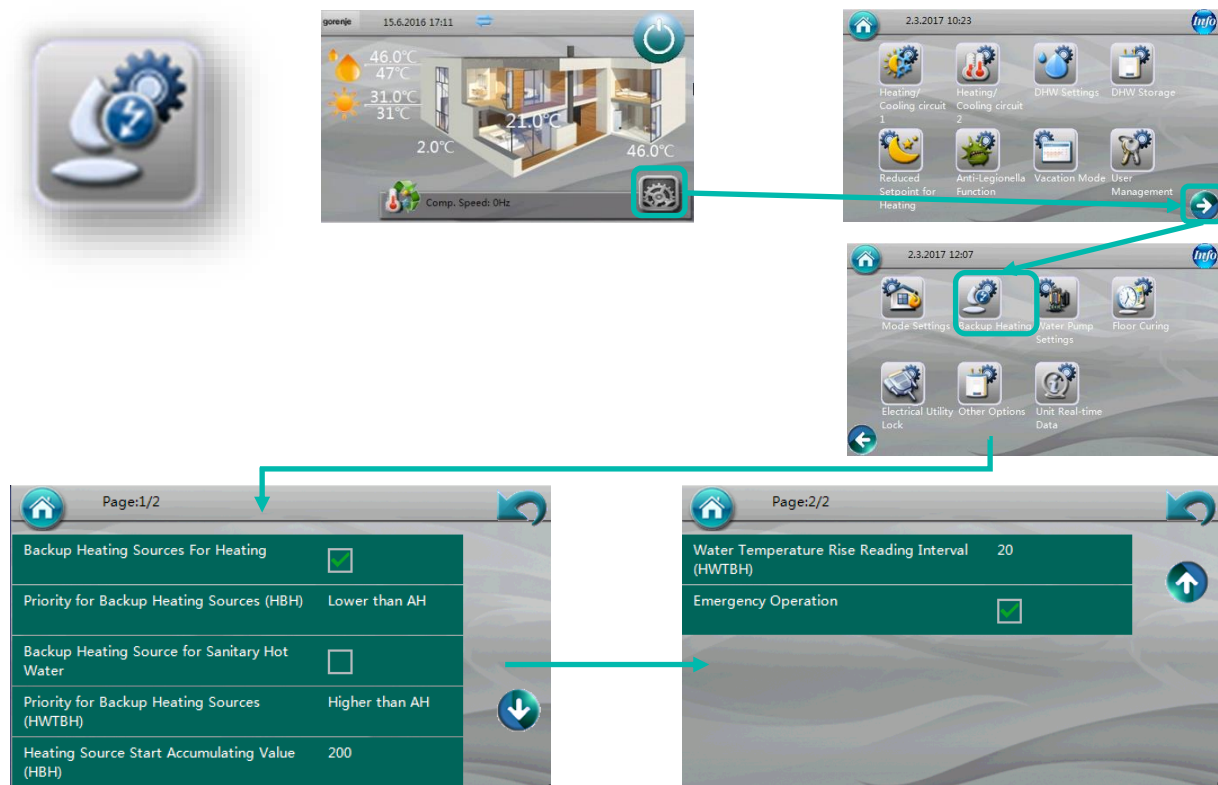

In the “Backup Heating” menu you can set the backup heating sources. By factory default, these heating sources are two-stage electric heaters that can be replaced with a different heating source (pellet burning furnace, oil burning furnace etc.). In this case, the heat pump regulates the switching on/off of the furnace.

## Meaning of abbreviations – HBH, HWTBH

- **HBH** (Heating Backup Heater) – second stage of electrical heater (default setting = 4Kw).  
Controlled by the Switch KM2.

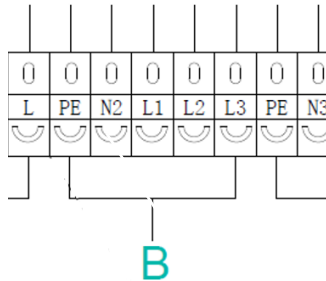

Second stage power supply is connected to L2 and L3 on port "B".  
**Note:** First stage (AH) power supply is connected to L1 on port "B".

- **HWTBH** (Hot water backup heater) – Electrical heater mounted directly in the DHW tank and controlled by the heat pump. It can be mono-phase or three-phase electrical heater  
Controlled by the Switch KM3.

### 6.11.1 Backup Heating Sources for Heating

Default setting = **Enabled**

**Enabled** – Heat Pump has 2 stage Backup heating (2kw + 4kW)

**Disabled** – Heat Pump has only one stage Backup heating (2kw)

### 6.11.2 Priority for Backup Heating Sources (HBH)

Setting which stage is the first and which will be the second stage in case of Backup heating needed for heating mode.

Lower than AH = First stage AH (KM1 - 2kW) and Second stage HBH (KM2 - 4kW) – default setting.

Higher than AH = First stage HBH (KM2 - 4kW) and Second stage AH (KM1 - 2kW).

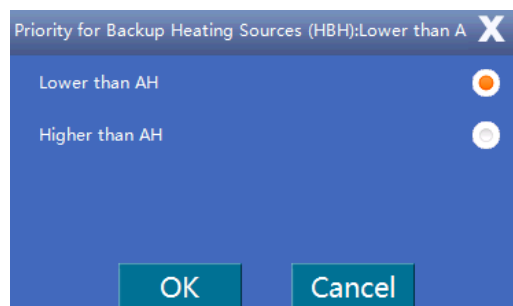

### 6.11.3 Backup Heating Source for Sanitary Hot Water

Default setting is Disabled.

**Enabled** – In case of Backup heating for DHW is needed, the Heat Pump will switch on the Electrical heater mounted directly on the DHW tank.

**Disabled** - In case of Backup heating for DHW is needed, the Heat Pump will use only the internal electrical heaters for Backup.

### 6.11.4 Priority for Backup Heating Sources (HWTBH)

Setting which stage is the first and which will be the second stage in case of Backup heating needed for DHW mode.

Lower than AH = First stage Internal electrical heater AH (KM1 - 2kW) and Second stage HWTBH (KM3 – Electrical heater mounted in the DHW tank)

Higher than AH = First stage HWTBH (KM3 - Electrical heater mounted in the DHW tank) and Second stage AH (KM1 - 2kW) – default setting

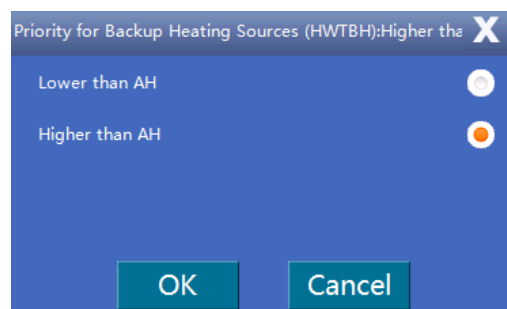

### 6.11.5 Heating Source Start Accumulating Value (HBH)

Default setting is 200.

Setting to tell the Heat pump when to start Backup heating source for Heating mode.

This is a spatially designed logic, which takes the  $\Delta T_{(T_{set} - T_{actual})}$  of the heating water and the temperature rising time for judging if Backup heating is needed.

Setting range is from 0 to 600.

If the number is low, the Backup heating will start sooner than if the number is set high

**Note:**

at Cold Start-up the Backup heaters will switch on fast, because of the high difference of the Set temperature and actual temperature ( $\Delta T_{(T_{set} - T_{actual})}$ ).

### 6.11.6 Water Temperature Rise Reading Interval (HWTBH)

Default setting is 20.

The units are minutes.

Setting how long will it take that the Backup starts in case that the temperature in the DHW tank doesn't rise for 1°C.

### 6.11.7 Emergency Operation

Default setting is Enabled

**Enabled** – if there is a fault on the Heat Pump, so that the compressor cannot start, the Heat pump will switch to emergency operation and start heating with Backup heating sources.

**Note:**

When Emergency operation is active, all set values will drop automatically by 7°C.



**Disabled** - if there is a fault on the Heat Pump, so that the compressor cannot start, the Heat pump **will not** switch to emergency operation, but it will just stop working until the fault is canceled. In this case, the house and the DHW may cool too much.

## 6.12 WATER PUMP SETTINGS

The screenshots illustrate the navigation path to the Water Pump Settings menu:

- Home Screen:** Shows a house icon and various temperature readings (46.0°C, 47°C, 31.0°C, 31°C, 2.0°C, 21.0°C, 46.0°C). A gear icon is highlighted.
- Menu Screen:** Shows a grid of settings icons. 'Water Pump Settings' is highlighted with a red box.
- Page 1/3:** Shows settings for Circulation Pump P0:
 

Circulation Pump P0 Type	DC Variable Speed Pump ( PWM )
Speed Setting of Circulation Pump P0	High Speed
Working Mode of Circulation Pump P0	Interval working mode
Pump Off Interval for P0	10
Pump On Time for P0	1
- Page 2/3:** Shows checkboxes for various operation modes:
 

Buffer Tank	<input type="checkbox"/>
P1 for Heating Operation	<input type="checkbox"/>
P1 for Cooling Operation	<input type="checkbox"/>
P1 with High Temp. Demand	<input type="checkbox"/>
P2 for Heating Operation	<input type="checkbox"/>
- Page 3/3:** Shows checkboxes for:
 

P2 for Cooling Operation	<input type="checkbox"/>
P2 with High Temp. Demand	<input type="checkbox"/>

### 6.12.1 Circulation Pump P0 Type

Setting the controlling type of the Circulating pump P0.

#### **P0 = Internal circulating pump**

The Internal circulating pump is controlled with PWM signal. In normal conditions, the signal is constant (according to parameter 6.11.2), only during Start-up when the system water temperature is low, the circulating pump runs with low speed to increase the condensing temperature – Condensing temperature control.

**Possible settings:**

**DC Variable Speed Pump (PWM Control)** - running according to parameter setting 6.11.2, Condensing temperature control.

**AC Pump** – No speed regulation, only high speed.

**6.12.2 Speed Setting of Circulation Pump P0**

Only value if parameter 6.11.1 is set to DC Variable Speed Pump (PWM Control).

Possible settings:

- High Speed (default setting)
- Middle Speed
- Low Speed

It is not recommended to change the Circulate pump speed, before consulting with Gorenje Engineers at HCS department.

**6.12.3 Working Mode of Circulation Pump P0**

Possible settings:

- Interval working mode – When the heat pump is not running (all the temperatures are achieved), circulation pump P0 is running according to parameters **Pump Off Interval for P0** and **Pump On Time for P0**. Default settings are OFF – 10min, On – 1min.
- ON constantly
- OFF with compressor – Circulation pump P0 works only when compressor is running.

**6.12.4 Pump Off Interval for P0**

Time for **Interval working mode** parameter where circulation pump P0 is deactivated.

Default setting is 10.

**6.12.5 Pump On Time for P0**

Time for **Interval working mode** parameter where circulation pump P0 is activated. Default setting is 1.

**6.12.6 Buffer Tank**

Check this box if a Buffer tank is installed in the system.

**6.12.7 P1 For Heating Operation**

Check this box if circulation pump P1 will be used for Heating.

**6.12.8 P1 For Cooling Operation**

Check this box if circulation pump P1 will be used for Cooling.

**6.12.9 P1 with High Temp. Demand (external switch input)**

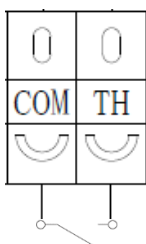

Check this box if you use a Room thermostat for Radiator heating for **heating circuit 1**. Circulation pump P1 only works when the signal from a Room thermostat is present. Room thermostat is connected to COM and TH connectors with a **non-voltage** contact.

**6.12.10 P2 for Heating Operation**

Check this box if circulation pump P2 will be used for Heating.

### 6.12.11 P2 for Cooling Operation

Check this box if circulation pump P2 will be used for Cooling.

### 6.12.12 P2 with High Temp. Demand

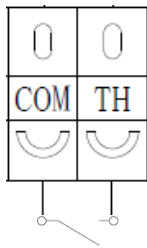

Check this box if you use a Room thermostat for Radiator heating for **heating circuit 2**. Circulation pump P2 only works when the signal from a Room thermostat is present. Room thermostat is connected to COM and TH connectors with a **non-voltage** contact.

#### **NOTE:**

Only one contact (COM and TH) is used for both High Temp. Demands. For this reason, use only one at a time.

## 6.13 FLOOR CURING

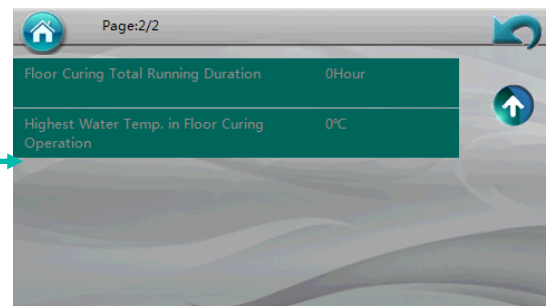
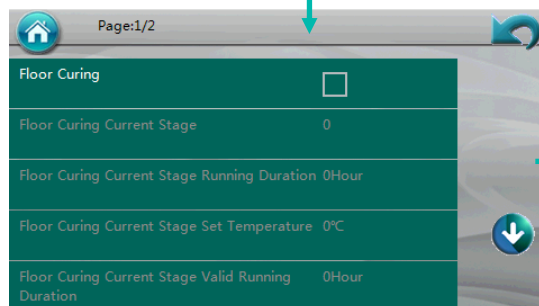

Floor Curing function is for thermal treatment of screeds.

### 6.13.1 Floor Curing

Default setting is disabled.

**Enabled** – Floor curing function is ON.

**Disabled** – Normal operation of the Heat pump.

It is a fully automatic function. During the duration of this function DHW mode will be automatically disabled.

The duration of the function depends on the ambient temperatures and moisture in the screed. Minimum duration is 30 days.

There are two main cycles of the function, which are divided in 24 steps – see graph below. After the function is finished, the Heat pump returns to normal operation.

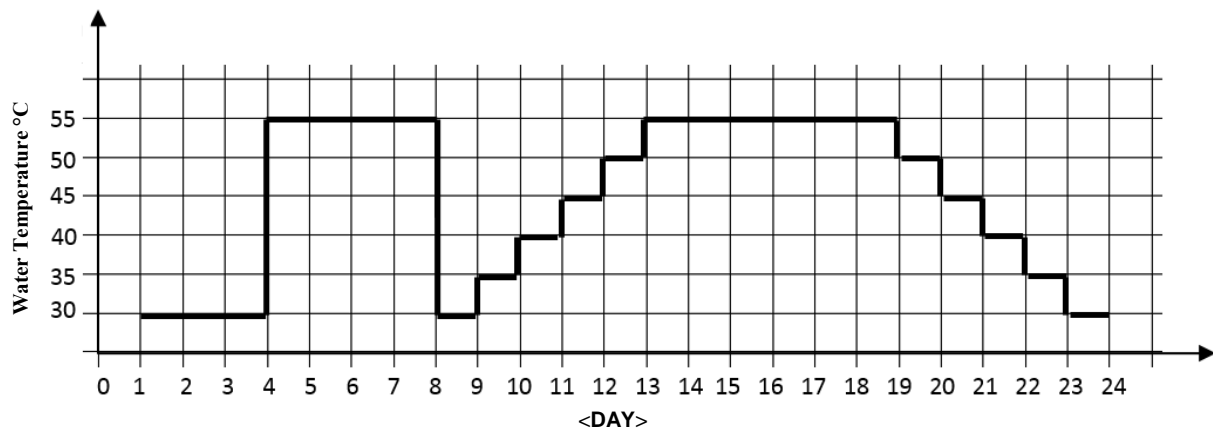

### 6.13.2 Floor Curing Current Stage

No setting, only display

Shows the correct working stage of the Floor curing function.

### 6.13.3 Floor Curing Current Stage Running Duration

No setting, only display

Shows the running duration of the correct working stage, meaning how long is the total running time of this stage.

### 6.13.4 Floor Curing Current Stage Set Temperature

No setting, only display.

Shows the set temperature of the correct working stage.

### 6.13.5 Floor Curing Current Stage Valid Running Duration

No setting, only display.

Shows the correct working stage running time in the desired water temperature.

### 6.13.6 Floor Current Total Running Duration

No setting, only display.

Total running time of the Function.

### 6.13.7 Highest Water Temp. in Floor Curing Operation

No setting, only display

Highest reached water temperature during Floor curing operation.

## 6.14 ELECTRICAL UTILITY LOCK

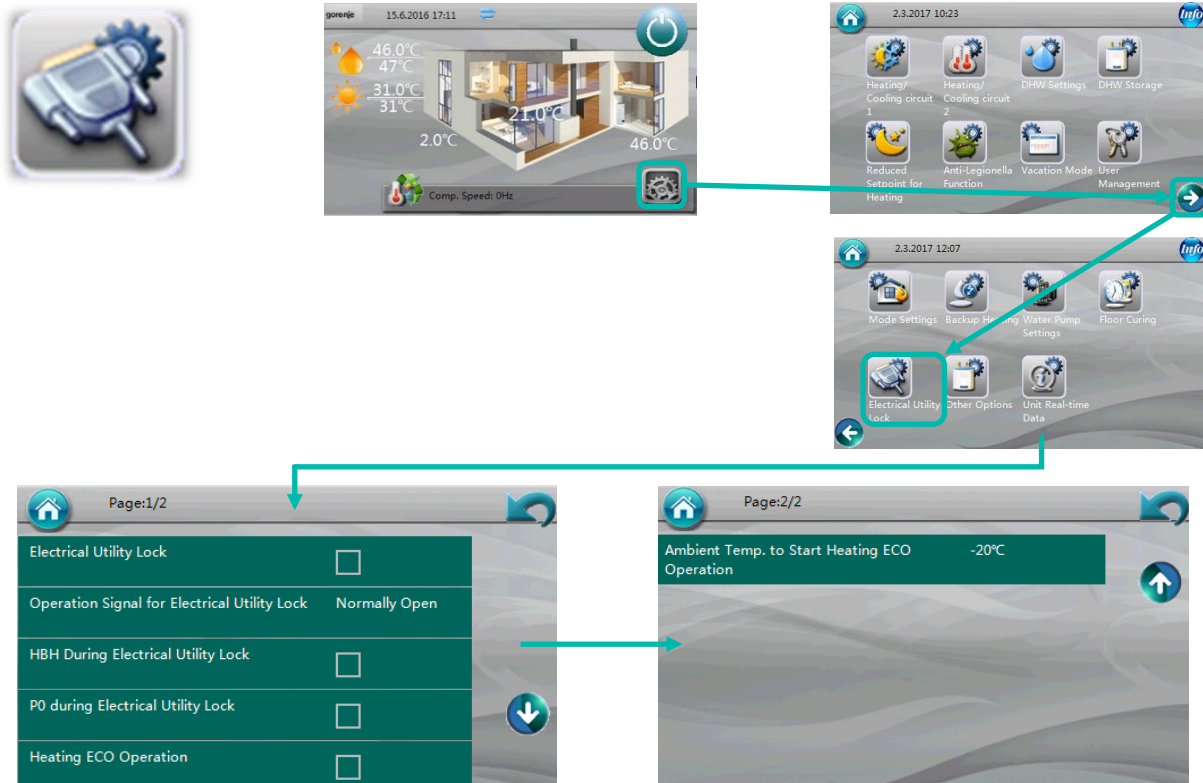

### 6.14.1 Electrical Utility Lock

Default setting is Disabled.

Electrical Utility Lock or EUL is used in some countries, where the Industry has a high demand on electrical power one or multiple times a day. The electricity distribution companies send a signal to Households that stops all high power electrical consumption systems. The heat pump belongs to this group, meaning it needs to stop during this time. If there is an additional heating source that is not in this EUL group, it can be automatically switched on during this period (see chapter 6.13.3).

A potential free contact is used and connected to the terminals ES and COM.

There are two possibilities of signal used for this function – Normally open (NO) and normally closed (NC).

If this function is enabled and a signal comes the compressor will stop for heating mode, DHW mode and Cooling mode.

For systems with active Electrical Utility Lock a buffer is recommended, so that the heat stored in the buffer can be used for heating the house.

### 6.14.2 Operation Signal for Electrical Utility Lock

Default setting is Normally Open.

Signal type can be selected according to the signal received from the distribution system.

**Normally Open** – function will be active when ES and COM are short-circuited.

**Normally Closed** - function will be active when ES and COM are open.

### 6.14.3 HBH During Electrical Utility Lock

Default setting is Disabled.

**Enabled** – During EUL active, the HBH (K2) will switch ON.

**Disabled** – No additional heating sources will switch ON.

By connecting an additional heating source to the second stage of Backup heating, it can be switched ON during the EUL is active.

Normally the HBH is the second sage of electrical heater, but the internal second stage electrical heater can be disconnected and on its place an additional heating source connected. HBH is switched ON by the contactor K2. By using its contacts an additional heating source can be switched ON like a gas boiler.

### 6.14.4 P0 during Electrical Utility Lock

Default setting is Disabled.

**Enabled** – P0 will work during EUL is active.

**Disabled** – P0 will STOP during EUL is active.

**Note:**

P0 is the internal circulating pump.

### 6.14.5 Heating Eco Operation

Default setting is Disabled.

Heating ECO Function (or Bivalent function) is for switching ON an additional heating source like a Gas boiler in could whether conditions. It this case, the compressor will STOP.

When active it will switch on contactor K2 (HBH – second stage internal electrical heater).

Meaning the second stage is connected to an additional heating source.

**For example:**

The Heating ECO Operation is enabled and the temperature to start the Heat ECO operation is set to -20°C. A Gas boiler is connected to the system as an additional heating source, controlled by the contactor K2 (HBH):

When the ambient temperature falls below -20°C, the compressor will stop and the heat pump will switch on the contactor K2 (HBH) to switch on the Gas boiler for heating the house. When the ambient temperature rises again over -20°C, the Heat pump will stop the Gas boiler and switch on the compressor for heating the house.

### 6.14.6 Ambient Temp. to Start Heating Eco Operation

Setting the ambient temperature for starting the Heat ECO Operation.

## 6.15 OTHER OPTIONS

These settings can be accessed only with service permission level.

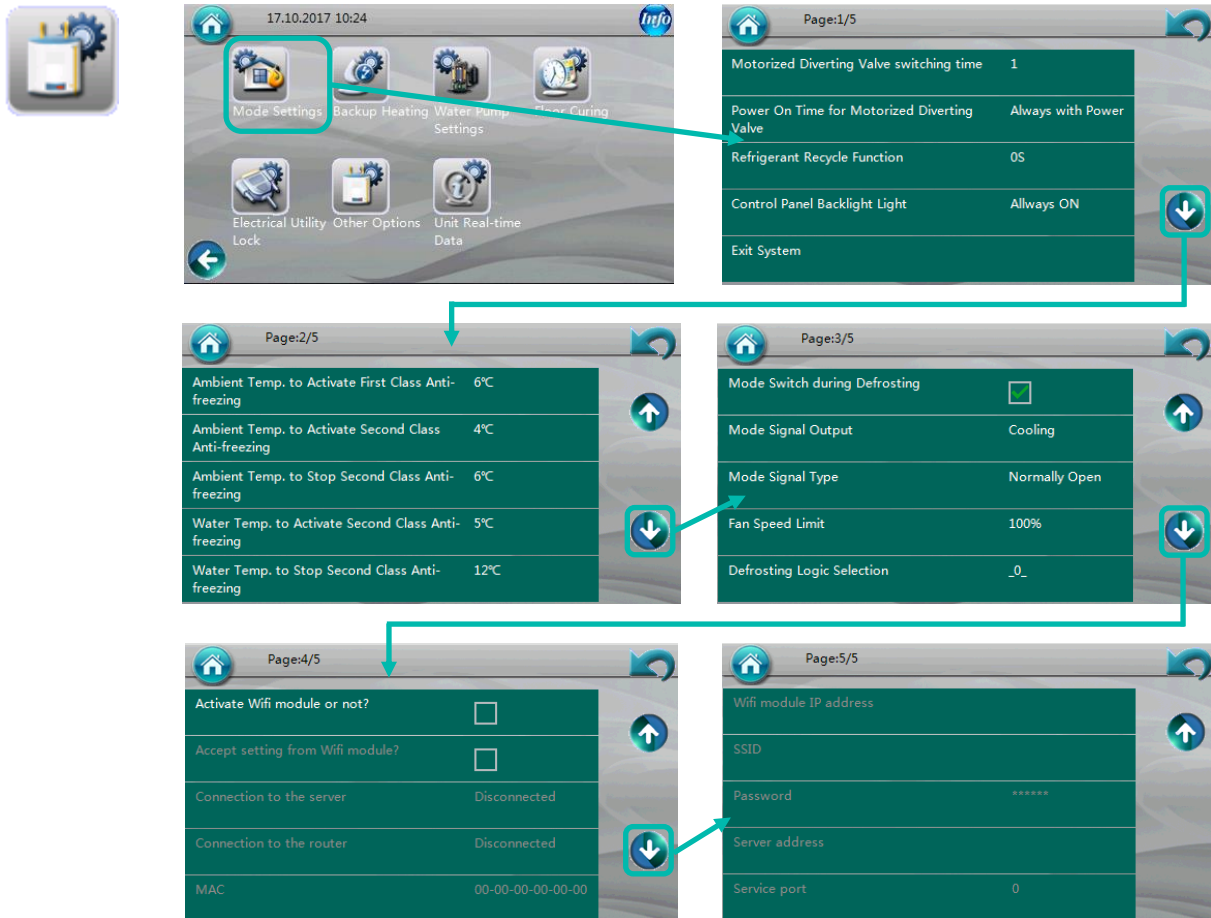

### 6.15.1 MOTORIZED DIVERTING VALVE SWITCHING TIME

Switching time of the diverting valve in minutes if the switching time of the diverting time is longer than the default setting (1min) change this value according to the diverting valve specification.

### 6.15.2 POWER ON TIME FOR MOTORIZED DIVERTING VALVE

Default setting: ALWAYS WITH POWER (set to 0). It determines how long will the diverting valve have power in switching to sanitary water.

### 6.15.3 REFRIGERANT RECYCLE FUNCTION

This is used for pumping the refrigerant back to outdoor unit. When turned on, it starts to count down the running time of this function (600s). When the **Refrigerant Recycle Function** is active, all safety features are disabled. You can stop this function by tapping on it again.

### 6.15.4 CONTROL PANEL BACKLIGHT LIGHT

Here you can adjust the time the display is turned on in these steps:

- Always on
- 3 min
- 5 min
- 10 min

### 6.15.5 EXIT SYSTEM

Pressing the Exit System button takes you to WinCE interface. This is used for updating indoor unit software. This can be accessed also on the main screen when the service permission level is active.

### 6.15.6 ANTI-FREEZING PROTECTION

the whole page 2 is for setting the anti-freezing protection.

- **Ambient Temp. to Activate First Class Anti-freezing**  
If Ambient temperature falls below this value, the circulating pumps will start to operate.
- **Ambient Temp. to Activate Second Class Anti-freezing**  
If Ambient temperature falls below this value, the compressor and all additional heating sources will start to operate.
- **Ambient Temp. To Stop Second Class Anti-freezing**  
If the Ambient temperature exceeds this value, First and Second class Anti-freeze protection will stop to operate.
- **Water Temp. to Activate Second Class Anti-freezing**  
If the Water temperature falls below this value, the compressor and all additional heating sources will start to operate.
- **Water Temp. to Stop Second Class Anti-freezing**  
If the Water temperature exceeds this value, First and Second class Anti-freeze protection will stop to operate.

### 6.15.7 MODE SWITCH DURING DEFROSTING

With this function off, the unit will start to defrost in the current working mode. If the water temperature is under 23°C, the unit will stop with error if there is not enough energy for safe defrost.

If this function is active, the unit will switch the working mode to the system that has water temperature higher than 23°C to make a safe defrost. After defrosting is done, the unit will switch back to required working mode.

### 6.15.8 MODE SIGNAL OUTPUT (MODE SWITCHING SIGNAL – MS)

With this function, you can determine when the MS contact will be active. You can select the activation during:

- **Cooling** (When the unit goes to cooling mode, MS gives signal according to selected **Mode Signal Type**).
- **Heating** (When the unit goes to heating mode, MS gives signal according to selected **Mode Signal Type**).

### 6.15.9 MODE SIGNAL TYPE (MODE SWITCHING SIGNAL – MS)

Here you can select if you want to have 230V on MS contact or not:

- **Normally open** (When the **Mode Signal Output** becomes active, 230 V will be on MS contact. When the **Mode Signal output** deactivates, 0 V will be on MS contact).
- **Normally closed** (When the **Mode Signal Output** becomes active, 0 V will be on MS contact. When the **Mode Signal output** deactivates, 230 V will be on MS contact).

### 6.15.10 FAN SPEED LIMIT

Here you can limit the maximum ventilator speed (90, 95, 100%).

We do not recommend changing this value because it can lower COP and heating capacity and it can cause improper operation of defrost.



#### **6.15.11 DEFROSTING LOGIC SELECTION**

Do not change this value except if Gorenje technical personnel ordered so. Changing this value without consulting Gorenje technical personnel voids warranty if the unit is damaged due to this cause. Defrost Logic Selection values are:

- **0**
- **1**
- **2**

#### **6.15.12 ACTIVATE WI-FI MODULE OR NOT?**

Check this box to activate Wi-Fi module.

#### **6.15.13 ACCEPT SETTING FROM WI-FI MODULE?**

Check this box to allow changing settings through Wi-Fi (especially useful for gorenje technical support).

#### **6.15.14 CONNECTION TO THE SERVER**

- **Connected** – WI-FI module is connected to the Gorenje Web Server.
- **Disconnected** – WI-FI module is not connected to the Gorenje Web server.

#### **6.15.15 CONNECTION TO THE ROUTER**

- **Connected** – WI-FI module is connected to the WI-FI router.
- **Disconnected** – WI-FI module is not connected to the WI-FI router.

#### **6.15.16 MAC**

Shows the MAC address of the Wi-Fi module. If the address is 00-00-00-00-00-00, please check the cable connection from the unit to the WI-FI module.

#### **6.15.17 WI-FI MODULE IP ADDRESS**

Shows the IP address of the WI-FI module from the WI-FI router.

#### **6.15.18 SSID**

Shows the name of the WI-FI router server to which is connected.

#### **6.15.19 PASSWORD**

Shows the WI-FI password. Password is shown only with the Service permission level enabled.

#### **6.15.20 SERVER ADDRESS**

Shows the automatically generated server address.

#### **6.15.21 SERVICE PORT**

Shows the automatically dedicated server port.

## 6.16 UNIT REAL-TIME DATA

Unit real-time data pages can be used for diagnostics of operation of the heat pump. On these pages, you can see everything that is happening in the heat pump in that moment. You can see different values for which include:

- Software Version
- Database Version
- Tuo, Tui, Tup, TW, TC temperature values
- Water Flow Rate
- Compressor Speed
- EEV operation
- Ambient Temperature (Actual, Average Temp. in 1 h, Average Temp. in 24 h)
- High pressure
- Low pressure
- Td, Ts, Tp temperature values
- ...

## 7 ERROR CODES

If some faults happen and some errors appear, it is not always because of the heat pump itself. The most errors happen due to the hydraulics system and especially in the first heating season (water pressure falls, air in the system, dirt in the piping...).

### 7.1 ERROR CODES SHOWN ON THE DISPLAY

The error codes will be shown on the Main display and in the Error Code Menu.

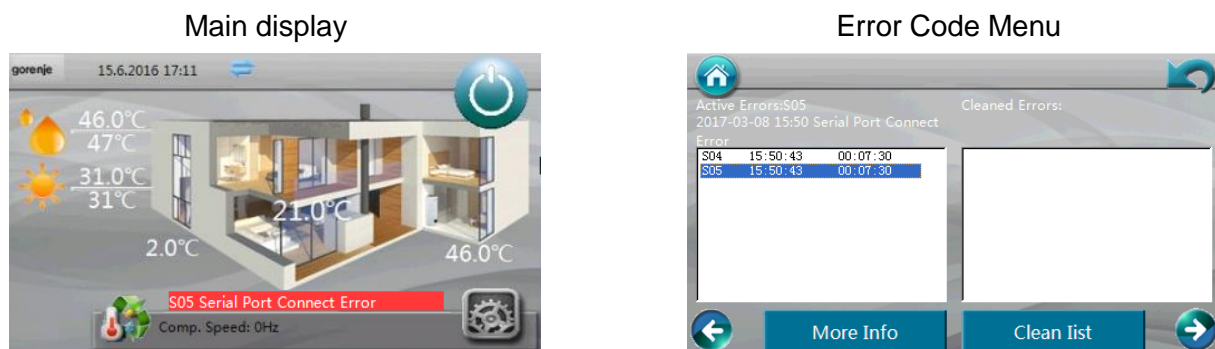

### 7.2 ERROR CODE MENU

#### 7.2.1 ACCESSING THE ERROR CODE MENU



## 7.2.2 INFORMATIONS IN THE ERROR CODE MENU

By pressing on the [Error code number](#), a more [detailed information](#) for this Error code will appear on the top.

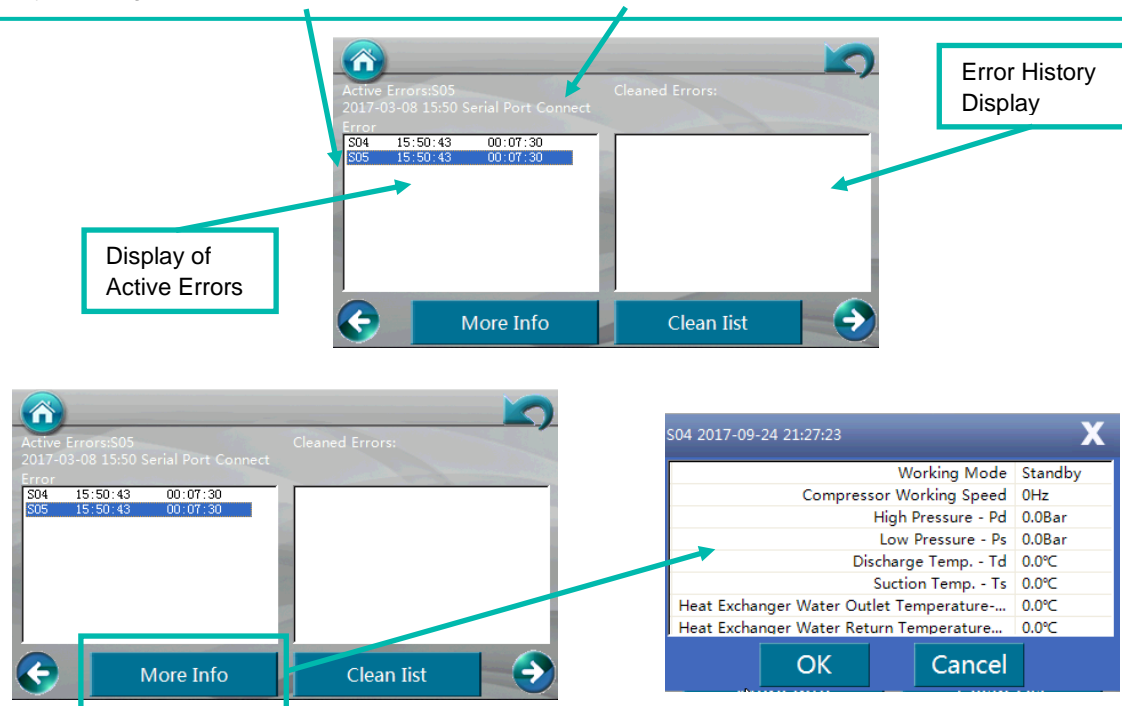

By selecting an Error code and pressing **More info** button, unit displays additional info regarding the status of the heat pump at the time when the error happened.

## 7.2.3 INFO PAGE

By pressing the and then takes you to the info page. First thing that is displayed is the hydraulic scheme with temperature readings from all the sensors. This screen is the same for all Aerogor Inverter heat pumps.

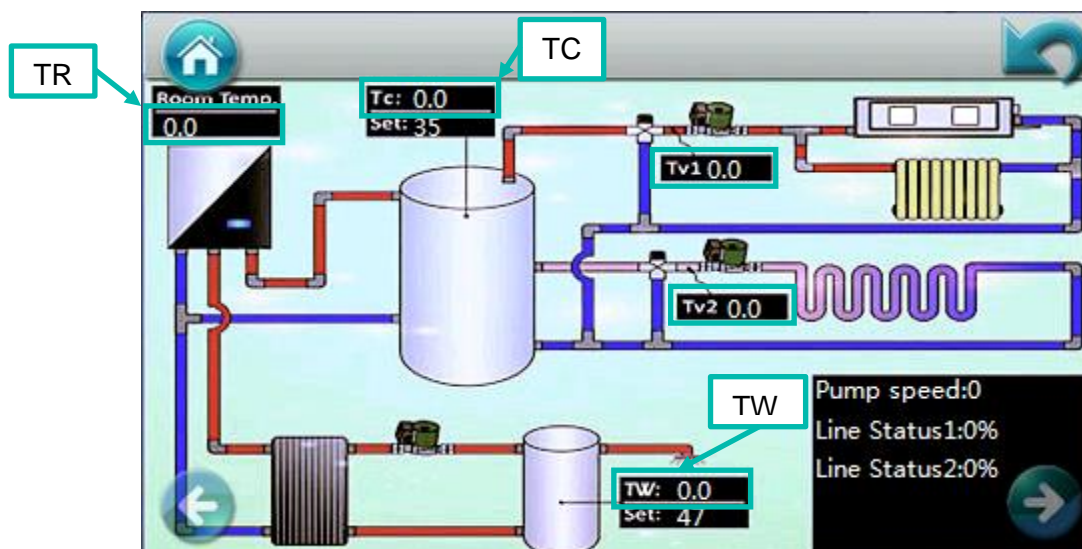

<b>TC</b>	Heating / Cooling (direct circuit or Buffer Tank)
<b>TW</b>	DHW Temperature
<b>TV1</b>	Mixing Circuit 1
<b>TV2</b>	Mixing Circuit 2
<b>TR</b>	Room Temperature
<b>Line status 1</b>	Communication – Touch Screen controller to the Indoor PCB 90 – 100 % = normal communication
<b>Line status 2</b>	Communication – Touch Screen controller to the Outdoor PCB 90 – 100 % = normal communication
<b>Pump speed</b>	100 = Pump P0 Activated 0 = Pump P0 Deactivated

By pressing the right arrow button  , the interface shows the heat pump system scheme. This scheme is different for ECO and POWER EVI inverters.

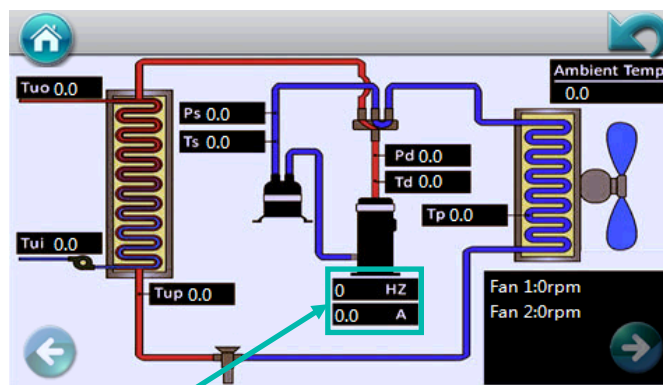

Aerogor ECO Inverter

Compressor speed (Hz)  
Compressor current (A)

Pe – Pressure EVI  
Te – Temperature EVI

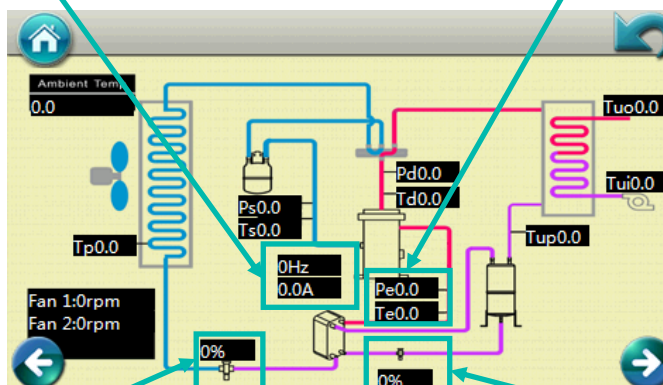

EEV  
Opening

Aerogor POWER EVI Inverter

EVI  
Opening

<b>Ta</b>	Ambient Temperature Sensor
<b>Tui</b>	Condenser Inlet Temperature Sensor
<b>Tuo</b>	Condenser Outlet Temperature Sensor
<b>Tup</b>	Liquid Refrigerant Temperature Sensor
<b>Ts</b>	Suction Temperature (Compressor) Sensor
<b>Td</b>	Discharge Temperature (Compressor) Sensor – Hot Gas Temperature
<b>Tp</b>	Evaporation Temperature Sensor
<b>Ps</b>	Low pressure – Suction pressure
<b>Pd</b>	High pressure – Discharge pressure
<b>Fan 1,2</b>	Fan speed for Fan 1 and Fan 2

## 7.3 ERROR CODE LIST

In this Code list are Notifications, Protections and Errors!

Category	Description	Symbol
<b>Notification</b>	Is only to inform the customer that some special function has turned on, which is still normal operation of the heat Pump.	*

Code	Name	What to do...	If nothing helps...
<b>P01</b>	Main line current protection	Compressor stops	<p>Input current is too high or too low or the system works in over-load condition. Unit recovers automatically after 5 minutes when it happened the first time. If same failure happens 3 times in a certain period of time, unit stops until repowered.</p> <p>Check unit input current. Check if the fan motor and circulation pump is working OK; Check if condenser is blocked; Check if the water temperature is too high and if the water temperature difference between inlet &amp; outlet is too big (should not be bigger than 8°C)</p>
<b>P02</b>	Compressor phase current protection	Compressor stops	<p>Compressor input current is too high or too low or the system works in over-load condition.</p> <p>Check compressor input current. Check if the fan motor and circulation pump are working OK; Check if the condenser is blocked; Check if the water temperature is too high and if the water temperature difference between inlet &amp; outlet is too big (should not be bigger than 8°C)</p>
<b>P03</b>	IPM module protection	Compressor stops	<p>Compressor drive failure. Check whether cable is broken or loosen. Check whether compressor driver PCB or compressor is broken.</p>

Code	Name	What to do...	If nothing helps...
P04	Compressor oil return protection	Compressor speed up	If unit has been continuously working in low speed for certain period of time, unit starts this protection to suck compressor oil back into compressor. This is a normal protection and doesn't need any treatment.
P05	Compressor shut down due to high/low pressure switch open caused by abnormal high/low pressure	Compressor stops	If system pressure is too high or too low, it activates this protection. Unit recovers automatically after 5 minutes when it happened the first time. If same failure happens 3 times in a certain period of time, unit stops until repowered. Check if the fan motor and circulation pump are working OK; Check if the condenser is blocked; Check if the water temperature is too high and if the water temperature difference between inlet & outlet is too big (should not be bigger than 8°C).
P06	Compressor speed down due to abnormal high pressure detected by condensing pressure sensor	Compressor speed down	This protection happens when system pressure is higher than the set compressor speed-down pressure point. If the pressure is still higher than the protection point after slowing down the compressor speed, compressor stops. Check if the water temperature set value is too high; Check if the system water flow rate is too small; Check if EEV works normally; Check if air circulates fluently in cooling mode; Check if temperature difference between water inlet & outlet is too big (should not be bigger than 8°C).
P07	Compressor preheating	Standard function, doesn't need any treatment.	This is a normal protection and doesn't need any treatment. When compressor did not work for long time and ambient temperature is low, compressor crankcase heater work for certain period of time before compressor start to warm up the compressor.
P08	Compressor discharge temp. too high protection	Compressor stops	Check if the water temperature set value is too high, especially when ambient temperature is low; Check if the water flow rate too small; Check if the system is lacking enough refrigerant.
P09	Outdoor evaporator coil temp. sensor protection	Compressor stops	Check if air circulates fluently in outdoor unit.
P10	AC over high/low voltage protection	Compressor stops	Unit input voltage too high or too low. Check the voltage of unit power supply.
P11	Compressor shut down due to too high/low ambient temperature	Compressor stops	Ambient temperature is too high or too low for unit to work.
P12	Compressor speed limited due to too high/low ambient temperature	Compressor speed down	Normal operation - no error
P14	Compressor speed limited due to low condensing pressure	Compressor speed down	Not enough refrigerant in the system, low inlet water temperature, Air flow on the evaporator restricted, EEV not working properly, broken cable to the EEV...
F01	Outdoor ambient temp. sensor failure - Ta	Compressor stops	Check if ambient temperature sensor is open, short-circuited or value drifts too much. Replace it if necessary.
F02	Outdoor evaporator coil temp. sensor failure - Tp	Compressor stops	Check if outdoor coil temperature sensor is open, short-circuited or value drifts too much. Replace it if necessary.

Code	Name	What to do...	If nothing helps...
F03	Compressor discharge temp. sensor failure - Td	Compressor stops	Check if compressor discharge temperature sensor is open, short-circuited or value drifts too much. Replace it if necessary.
F04	Outdoor Suction temp. sensor failure - Ts	Compressor stops	Check if outdoor suction temperature sensor is open, short-circuited or value drifts too much. Replace it if necessary.
F05	Evaporating pressure sensor failure - Ps	Compressor stops	Check if evaporating temperature sensor is open, short-circuited or broken. Replace it if necessary.
F06	Condensing pressure sensor failure - Pd	Compressor stops	Check if condensing temperature sensor is open, short-circuited or broken. Replace it if necessary.
F07	High/low pressure switch failure	Compressor stops	If pressure switch is in open position when unit is in standby state or 2 minutes after compressor stops, unit gives this failure. Check if high or low-pressure switch is broken or not well connected.
F09	DC fan failure (A)	Compressor speed down	Speed of DC fan (or one of the DC fans for dual fan system) can't reach the required value or no feedback signal. Please check whether the PCB or fan motor is broken.
F10	DC fan failure (B)	Compressor stops	Speed of both DC fans (for dual fan system) can't reach the required value or no feedback signal. Please check if the PCB or fan motor is broken.
F11	System evaporating pressure too low	Compressor stops	If system too low-pressure protection detected by evaporating pressure sensor happened 3 times in a certain period of time, it gives this failure code and unit can't be restarted until repowered. Check if the system has enough refrigerant or if there is a leakage inside (more likely it is not enough refrigerant that caused this abnormal evaporating pressure); Check if the fan motor and circulation pump are working OK; Check if condenser is blocked; Check if EEV works normally; Check if the water temperature is too low and if the water temperature difference between inlet & outlet is too big in cooling (should not be bigger than 8°C).
F12	System condensing pressure too high	Compressor stops	If system too high-pressure protection detected by condensing pressure sensor happened 3 times in a certain period of time, it gives this failure code and unit can't be restarted until repowered. Check if the water flow rate is not enough (more likely it is not enough water flow rate that caused system build up too high pressure); Check if the fan motor and circulation pump is working OK; Check if the condenser is blocked; Check if EEV works normally; Check if the water temperature is too high and if the water temperature difference is too big between inlet & outlet (should not be bigger than 8°C).

Code	Name	What to do...	If nothing helps...
E01	Communication between operation panel and indoor PCB or outdoor PCB failure	Compressor stops	Communication failure between operation panel and the indoor or outdoor PCB. Check the cable connection in between. Check if the last three switches on outdoor power PCB are set to 001; Check the last three switches on indoor PCB are set to 001. Unit recovers when communication recovers.
E02	Outdoor power PCB and driver PCB communication failure	Compressor stops	Check the communication cable between outdoor power PCB and driver PCB. Check if the outdoor power PCB and driver PCB is broken.
E03	Compressor phase current failure (open/short circuit)	Compressor stops	Check if the power cable to the compressor is broken or short-circuited.
E04	Compressor phase current overload (over current)	Compressor stops	Check if the power cable to compressor is broken or short-circuited.
E05	Compressor driver failure	Compressor stops	Check if the compressor drive PCB is broken, or the cable to compressor is connected wrong.
E06	Module VDC over high/low voltage failure	Compressor stops	Input voltage too high or too low.
E07	AC current failure	Compressor stops	Check the current to outdoor unit, and compare it with the unit current shown on the operation panel. If the difference is not big, check if the system has enough refrigerant (more likely it is not enough refrigerant that caused this abnormal low current). If the difference is big, outdoor power PCB is broken. Please replace it with a new one;
E08	EEPROM failure	Compressor stops	Cut the unit power and short-circuit JP404 port on outdoor power PCB, repower the unit, cut power again and cancel the short-circuit on JP404 port. If still not OK, replace the outdoor power PCB.
E10	Communication error	Unit stops	Check if the communication wires are loosen or off.
E11	Clock error	Unit stops	Change with new controller
E12	Ext. Memmory error	Unit stops	Change with new controller
E13	High pressure protection	Unit stops	1. Too much refrigerant. Reclaim and vacuum and inject the correct amount. 2. There is air inside the refrigerant system. Vacuum again and inject refrigerant again. 3. Too low water flow. Check the water system and circulating pumps, increase water flow. 4. Condenser is dirty and is blocked inside. Wash it. 5. EEV does not work. Check its wiring and if its coil is ok or not.
E14	Low pressure protection	Unit stops	1. Filter in the refrigerant system is blocked, change a new one to clean the inside refrigerant system. 2. EEV does not work. Check its wiring and if its coil is OK or not. 3. EEV inside is blocking. Change the EEV and clean the refrigerant system. 4. Refrigerant leakage. Check and find the leakage point an fix it. Vacuum and inject new refrigerant.
E15	Power plus offline	Unit stops	Communication between CPP controller and POWER+ driver is OFF. Check if the wiring is loosen or not.



Code	Name	What to do...	If nothing helps...
E16	Power plus generic AL	Unit stops	Check if the 3 phase power for outdoor unit is OK or not. If it is OK, the Power plus driver is defective, replace the Power plus driver.
E17	EVO sensor error	Unit stops	Sensor wires are off or defective. Check if the wires are loosen or if the sensor body resistance is OK or not. If the resistance is not OK, replace the sensor.
E18	Low superheat EVO	Unit stops	<ol style="list-style-type: none"> <li>1. Too much refrigerant. Reclaim and vacuum and inject the correct amount.</li> <li>2. Refrigerant system leakage, not enough refrigerant. Check and fix the leakage, vacuum and inject again.</li> <li>3. Bad ventilation condition for outdoor unit fans. Check if there is an obstacle at the fan system.</li> <li>4. Not enough evaporating area after the eavaporator is frosted. Check if the defrost coil sensor is positioned correctly and if it can measure the temperature correctly.</li> </ol>
E19	Lov evap. Temp. EVO	Unit stops	<ol style="list-style-type: none"> <li>1. Not enough evaporating area after the eavaporator is frosted. Check if the defrost coil sensor is positioned correctly and if it can measure the temperature correctly.</li> <li>2. Refrigerant system leakage, not enough refrigerant. Check and fix the leakage, vacuum and inject again.</li> <li>3. Filter of the refrigerant system is dirty and blocking, change a new one and clean the refrigerant system.</li> </ol>
E20	High evap. Temp. EVO	Unit stops	<ol style="list-style-type: none"> <li>1. Bad ventilation condition for outdoor unit fans. Check if there is an obstacle at the fan system.</li> <li>2. Not enough water flow leads to low heat exchange in condenser. Check the water system and Discharge inside air, make sure pumps 1 and 2 are powerful enough to run the water system.</li> <li>3. Sensor is defective or bad connection. If it is connected correctly, check its wiring, if the wiring is OK, replace the sensor.</li> <li>4. The suction temp. sensor is loosen. Plug it back to its position and make sure the heat preservation is good.</li> <li>5. Refrigerant leakage. Find and fix the leakage, vacuum and inject refrigerant again.</li> <li>6. Sensors of main EEV and EVI EEV mix each other. Check the both sensors according to wiring scheme.</li> </ol>
E21	Low suction temp. EVO	Unit stops	<ol style="list-style-type: none"> <li>1. Too much refrigerant. Reclaim and vacuum and inject the correct amount.</li> <li>2. Filter if the refrigerant system is dirty and blocking, change a new one and clean the refrigerant system.</li> <li>3. Bad ventilation condition for outdoor unit fans. Check if there is an obstacle at the fan system.</li> <li>4. Not enough evaporating area after the eavaporator is frosted. Check if the defrost coil sensor is positioned correctly and if it can measure the temperature correctly.</li> </ol>
E22	Comp. Start failure	Unit stops	Hardware failure, compressor or POWER+ driver has a problem. Change the compressor or change the POWER+ driver.
E23	Envelop error	Unit stops	
E24	Low press. Differential error	Unit stops	

Code	Name	What to do...	If nothing helps...
E25	High discharge temp.	Unit stops	<ol style="list-style-type: none"> <li>1. There is air inside the refrigerant system. Vacuum again and inject new refrigerant.</li> <li>2. Not enough water flow leads to low heat exchange in condenser. Check the water system and Discharge inside air, make sure pump 1 and 2 are powerful enough to run the water system.</li> <li>3. Plate heat exchanger condenser is dirty and blocking at water side. Wash it.</li> <li>4. Filter if the refrigerant system is dirty and blocking, change a new one and clean the refrigerant system.</li> <li>5. Refrigerant leakage. Find and fix the leakage, vacuum and inject refrigerant again.</li> </ol>
E26	Amb. temp. probe fault(B1)	Unit stops	Sensor wiring is loosen or sensor is defective. Check the wiring, if wiring is ok, check the sensors resistance. If resistance is not OK, replace the sensor.
E27	Outdoor unit alarm : Evap. coil temp.probe fault (B2)	Unit stops	Sensor wiring is loosen or sensor is defective. Check the wiring, if wiring is ok, check the sensors resistance. If resistance is not OK, replace the sensor.
E28	Outdoor unit alarm Suction temp. Probe fault	Unit stops	Sensor wiring is loosen or sensor is defective. Check the wiring, if wiring is ok, check the sensors resistance. If resistance is not OK, replace the sensor.
E29	Outdoor unit alarm Comp. discharge probe	Unit stops	Sensor wiring is loosen or sensor is defective. Check the wiring, if wiring is ok, check the sensors resistance. If resistance is not OK, replace the sensor.
E30	B5 temp. prob fault	Unit stops	Sensor wiring is loosen or sensor is defective. Check the wiring, if wiring is ok, check the sensors resistance. If resistance is not OK, replace the sensor.
E31	Outdoor unit alarm Suction pressure sensor	Unit stops	Sensor wiring is loosen or sensor is defective. Check the wiring, if wiring is ok, check the sensors resistance. If resistance is not OK, replace the sensor.
E32	Outdoor unit alarm : Discharge pressure sensor fault (B7)	Unit stops	Sensor wiring is loosen or sensor is defective. Check the wiring, if wiring is ok, check the sensors resistance. If resistance is not OK, replace the sensor.
E33	Outdoor unit alarm : Defrost time too long	Unit stops	Sensor wiring is loosen or sensor is defective. Check the wiring, if wiring is ok, check the sensors resistance. If resistance is not OK, replace the sensor.
E34	Outdoor unit alarm : Gas Pressure differ. too high at Comp. Start	Unit stops	Only displayed on outdoor software interface. This alarm normally would happen after the unit stops and before re-start.
E35	Outdoor unit alarm : EVI Sunction temp probe fault (B8)	Unit stops	Sensor wiring is loosen or sensor is defective. Check the wiring, if wiring is ok, check the sensors resistance. If resistance is not OK, replace the sensor.
E36	Outdoor unit alarm : EVI sunction pressure probe fault (B11)	Unit stops	Sensor wiring is loosen or sensor is defective. Check the wiring, if wiring is ok, check the sensors resistance. If resistance is not OK, replace the sensor.

Code	Name	What to do...	If nothing helps...
E37	High press. switch defect	Unit stops	<ol style="list-style-type: none"> <li>1. Too much refrigerant. Reclaim and vacuum and inject the correct amount.</li> <li>2. There is air inside the refrigerant system. Vacuum again and inject new refrigerant.</li> <li>3. Not enough water flow leads to low heat exchange in condenser. Check the water system and discharge inside air, make sure pumps 1 and 2 are powerful enough to run the water system.</li> <li>4. Plate heat exchanger condenser is dirty and blocking at waterside. Wash it.</li> <li>5. EEV does not work. Check its wiring or if its coil is OK or not.</li> <li>6. The check valves at the outdoor unit are not opened.</li> </ol>
E38	Low press. switch defect	Unit stops	<ol style="list-style-type: none"> <li>1. Too much refrigerant. Reclaim and vacuum and inject the correct amount.</li> <li>2. Filter if the refrigerant system is dirty and blocking, change a new one and clean the refrigerant system.</li> <li>3. Bad ventilation condition for outdoor unit fans. Check whether there is obstacle at the fan system.</li> <li>4. Not enough evaporating area after the evaporator is frosted. Check if the defrost coil sensor is positioned correctly and if it can measure the temperature correctly.</li> </ol>
E39	Outdoor unit alarm : EVI Low superheat	Unit stops	
E40	EVI low evap. Temp.	Unit stops	
E41	EVI high evap. Temp.	Unit stops	
E42	Outdoor unit alarm : Amb. Temp. out of HP working range	Unit stops	Too high/low outdoor ambient temperature. Check whether the ambient sensor is installed correctly or not.
E43	Outdoor unit alarm : Outlet water temp. Too low	Unit stops	Avoid too low water outlet temperature in cooling mode, protect the plate heat exchanger. This Alarm can be cleared only after power is cut off.
F13	Room temp. sensor failure	Unit stops	Check if room temperature sensor is open, short-circuited or value drifts too much. Replace it if necessary.
F14	Sanitary hot water temp. sensor failure	Unit stops	Check if sanitary hot water temperature sensor is open, short-circuited or value drifts too much. Replace it if necessary.
F15	Cooling/heating water temp. sensor failure	Unit keeps on working, use "unit water inlet temperature" as reference.	Check if cooling/heating water temperature sensor is open, short-circuited or value drifts too much. Replace it if necessary.
F16	Unit water outlet temp. sensor failure	Unit keeps on working, use "unit water inlet temperature" as reference.	Check if unit water outlet temperature sensor is open, short-circuited or value drifts too much. Replace it if necessary.
F17	Unit water inlet temp. sensor failure	Unit keeps on working, use "unit water outlet temperature" as reference.	Check if unit water inlet temperature sensor is open, short-circuited or value drifts too much. Replace it if necessary.
F18	Indoor coil temp. sensor failure	Unit keeps on working, except cooling mode.	Check if indoor temperature sensor is open, short-circuited or value drifts too much. Replace it if necessary.

Code	Name	What to do...	If nothing helps...
<b>F21</b>	Mixture valve 1 temperature sensor failure	Unit keep on working, mixture valve 1 output fixed to 0.	Check if TV1 temperature sensor is open, short-circuited or value drifts too much. Replace it if necessary.
<b>F22</b>	Mixture valve 2 temperature sensor failure	Unit keep on working, mixture valve 2 output fixed to 0.	Check if TV2 temperature sensor is open, short-circuited or value drifts too much. Replace it if necessary.
<b>F25</b>	Communication between operation panel and indoor PCB or outdoor PCB failure	Unit stops	Communication failure between operation panel and the indoor or outdoor PCB. Check the cable connection in between. Check if the last three switches on outdoor power PCB are set to 001; Check if the last three switches on indoor PCB are set to 001. Unit recovers when communication recovers.
<b>F27</b>	Indoor EEPROM failure	Unit keeps on working	Cut the unit power, connect CN213-5 and CN213-6 together, repower the unit and then cut the power and cancel the connection. If still not OK, replace the indoor PCB.
<b>F28</b>	Circulation pump PWM signal feedback failure	Unit keeps on working	Check the circulating pump cable connection; Check the power supply to the circulating pump; Check if the circulating pump is broken.
<b>F29</b>	Mixture valve 1 failure	Unit keep on working, mixture valve 1 output fixed to 0.	Check MV1 cable connection; Check the PCB output voltage signal; Check if the MV1 is broken.
<b>F30</b>	Mixture valve 2 failure	Unit keep on working, mixture valve 2 output fixed to 0.	Check MV2 cable connection; Check the PCB output voltage signal; Check if the MV2 is broken.
<b>S01</b>	Indoor anti-freezing protection in cooling	Compressor speed down or stop	Compressor speed down if coil temp. lower than 2°C; Compressor stops if coil Temp. lower than -1°C; Compressor restarts if coil Temp. higher than 6°C. Check if the set temperature for cooling is too low; Check if the system has too small water flow rate; Check the water system especially the filter. Check if the system has not enough refrigerant inside by measuring the evaporating pressure. Check if the ambient temperature is lower than 15°C.
<b>S02</b>	Too small water flow rate	Compressor stops	System water flow rate is less than minimum allowable flow rate. Check the water system, especially the filter; Check the working statue of water pump.
<b>S03</b>	Water flow switch failure	Warning but unit keeps on working	Water flow switch failed to work. Check if the flow switch is broken or not well connected.
<b>S04</b>	Communication failure	Unit stops	Communication data lost too much. Check if the communication cable is longer than 30M; Check if there is a source of disturbance nearby the unit. Unit recovers when communication recovers.











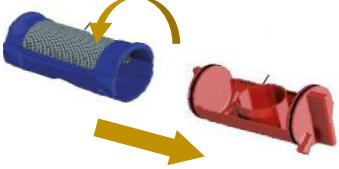

Code	Name	What to do...	If nothing helps...
<b>S05</b>	Serial port connect error	Unit stops	Communication failure between operation panel and the indoor or outdoor PCB. Check the cable connection in between. Check if the last three switches on outdoor power PCB are set to 001; Check if last three switches on indoor PCB are set to 001. Unit recovers when communication recovers.
<b>S06</b>	Water outlet Temp. too low protection in cooling	Compressor stops	Compressor stops if water outlet is lower than 5°C in cooling mode. Check if the temperature sensor Tc is OK and well connected; Check if the set water temperature too low Check if the system flow rate too small.
<b>S07</b>	Water outlet Temp. too high protection in heating/hot water	Compressor stops	Compressor stops if water outlet is higher than 57°C in heating or hot water mode. Check if the temperature sensors Tc and Tw is OK and well connected; Check if the set water temperature is too high; Check if the system flow rate is too small.
<b>S08</b>	Unit defrosting failure	Unit Stops and can only be restarted by repowering the unit	System water temperature is too low for defrosting. Please either set the temperature higher, have the back-up heating source connected or close some heating circuit to let the system enough high-water temperature for a safe defrosting.
<b>S09</b>	Water outlet Temp. too low protection in defrosting	Quit current defrosting operation	If water outlet temperature is lower than 15°C during defrosting, water may freeze up in the plate heat exchanger and cause damage, so unit will quit current defrosting mode. It will try again in next defrosting cycle but if it continuously failed to make the defrosting for 3 times, it shows S08 failure code and can only be restarted by repower the unit. Please either set the temperature higher, have the back-up heating source connected or close some heating circuit so to let the system has enough high-water temperature for a safe defrosting.
<b>S10</b>	Too small water flow rate failure	Compressor stops	If "too small water flow rate protection" happens over 3 times in certain period of time, it gives this failure code and unit stops until repower. This failure means the system water flow rate is less than minimum allowable flow rate. Check the water system, especially the filter; Check the working statue of water pump.
<b>S11</b>	Indoor anti-freezing failure in cooling	Compressor stops	If "indoor coil anti-freezing protection in cooling mode" happens over 3 times in certain period of time, it gives this failure code and unit stops until repower. Check whether set temperature for cooling is too low; whether system has too small water flow rate; check water system especially the filter. Check whether system has not enough refrigerant inside by measuring the evaporating pressure. Check whether ambient temperature is lower than 15°C.
<b>S12</b>	Floor curing function failed to finish	Unit switch back to standard working mode with failure information shown on the screen	If floor curing function can't be finished in the maximum allowable time, it shows this information. Unit will go back to normal working mode, with failure information shown on the display. Failure information can only be erased until repower or start the floor curing function again.

## 8 CLEANING THE MAGNETIC/DIRT FILTER CALEFFI

The Filter should be cleaned at the beginning and of the heating season.

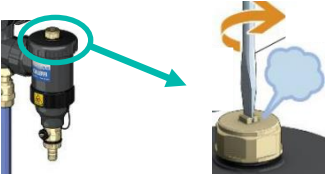
**Note:**

First heating season, it is recommended to clean the Filter first time after 1 month working of the heat pump and until the end of the first heating season every 2 months. If there is still much dirt collecting in the filter, repeat this procedure until the system is free of excessive dirt.

<p>1. Turn OFF the heat pump with the ON/OFF button and wait for min 5 minute before proceeding to the next step.</p> 	<p>2. Close the hand valves.</p> 	<p>3. Remove the Magnet and wait for 5 minutes before proceeding to the next step.</p> 
<p>4. Drain the dirty water.</p> 	<p>5. Remove the Dirt Filter.</p> 	<p>6. Remove the strainer from the holder.</p> 
<p>7. Clean the strainer with warm water under a tap.</p> 	<p>8. Reassemble the filter and close the draining valve.</p> 	<p>9. Open the hand valve on the low side.</p> 
<p>10. Purge the air from the Filter.</p> 	<p>11. Retrieve the Magnet.</p> 	<p>12. Open the upper hand valve.</p> 
<p>13. Start the Heat Pump with the ON/OFF button.</p> 		

## 9 WATER PRESSURE IN THE SYSTEM

Water pressure must always stay above 1 bar of pressure. If the pressure falls below 1 bar, the Heat Pump will go in to protection S02 or S10, which can stop the Unit from working. Recommended water pressure when the unit is working is 1,5 bar and when it stays still approx. 1,8 bar.

On the top of the Indoor Unit (Aerogor ECO Inverter 10 AS, 13 AS and Aerogor POWER EVI Inverter 15 AS, 18 AS) is a manometer, which shows the water pressure of the system water. See photo below:

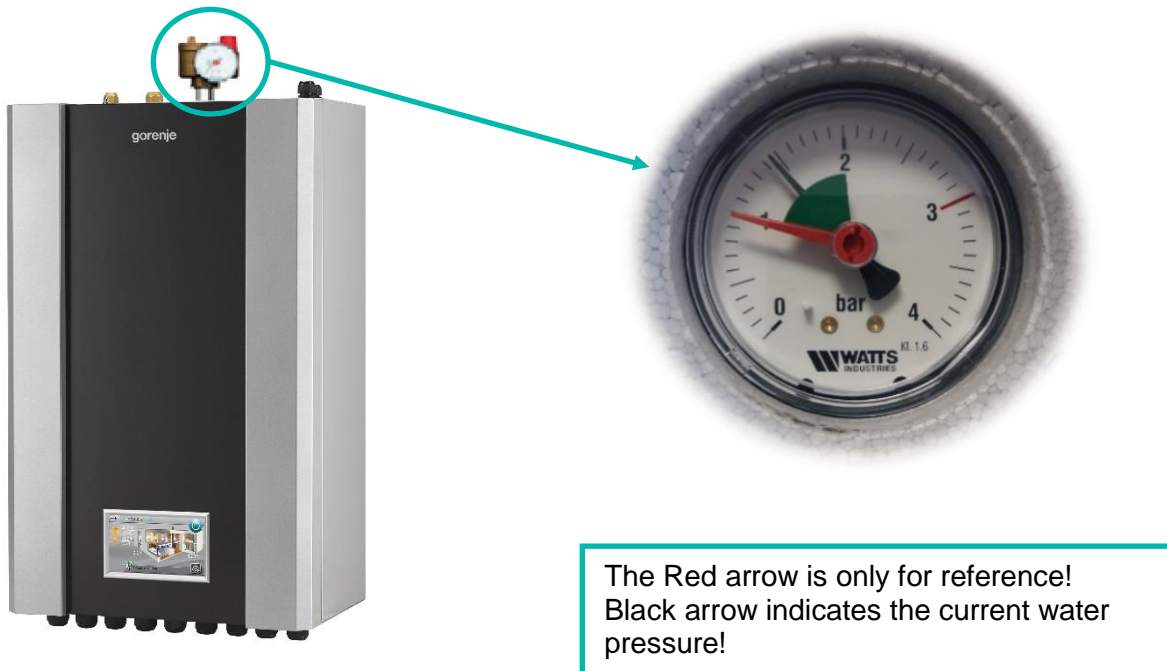

**Note:**

Make sure that the water pressure stays always at approx. 1,5 bar (when Heat Pump is working)!

## 10 EMERGENCY SWITCH

**Emergency Switch is for manual emergency operation of the unit.**

**If Emergency Switch is OFF** – unit works normal according to the settings on the Main Controller (7" LCD).



**If Emergency Switch is ON** – The circulating pumps P0, P1 and P2 start to work. Temperature control is according to settings of the additional thermostat by switching ON and OFF the both stages of Back-up heating system (default is 6kW of electrical heaters). Diverting valve must be manually switched to heating or DHW position.



**Note:**

This Emergency Switch is switched on only if there is a major controller malfunction.



## 10.1 LOCATION OF THE EMERGENCY SWITCH

### ALL-IN-ONE Inverter AS

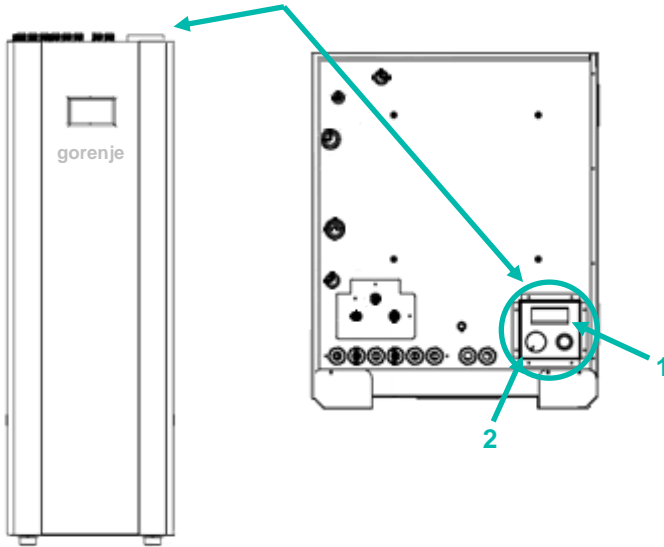

### AEROGOR Inverters AS

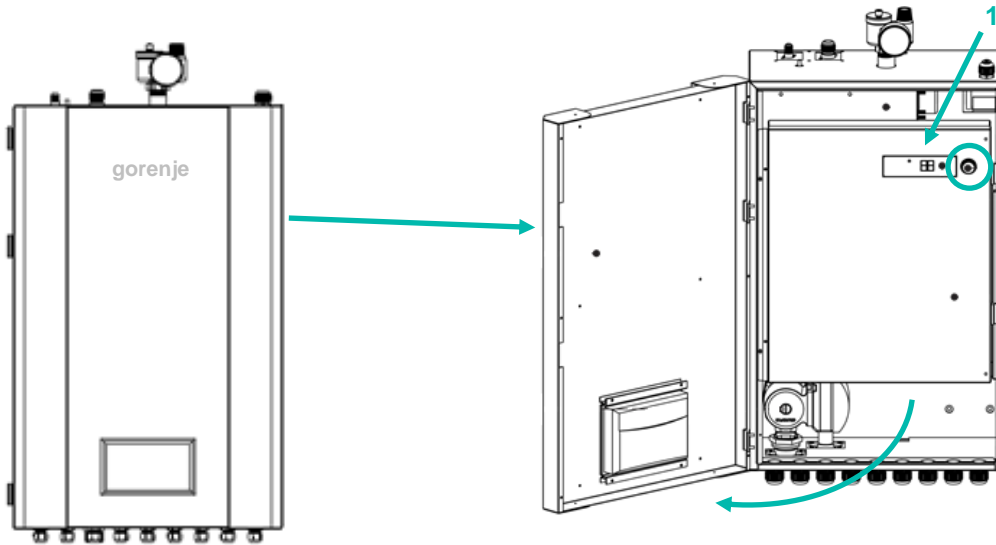

1. **Digital thermostat** controls the max flow temperature in case of Back-Up or Auto–Emergency operation. In the Back-Up and Auto–Emergency operation, the Main controller is still controlling the heating temperature.

**Auto – Emergency operation**

Example:

If the Unit turns ON the Back-Up heaters or Emergency operation and the setting on the Digital thermostat is set to 30°C, the heaters will work only until 30°C and then switch OFF regardless of the demand from the main controller. If, however the Digital thermostat is set to 60°C, the Main controller will switch OFF the heaters according to its needs.

**Manual operation** (manual emergency switch ON):

In manual operation all the circulating pumps are switched ON and the Electrical heaters work according to the setting on the Digital thermostat, regardless of the setting on the Main controller.

Example:

if the Manual emergency operation is ON and the temperature set on the Digital thermostat is set to 50, the heating water will be heated to 50°C. The Circulating pumps will run all the time.

2. **Analog thermostat** controls the max flow temperature in case of Back-Up or Auto – Emergency operation for DHW. In Back-Up and Auto–Emergency operation, the Main controller is still controlling the DHW temperature.

**Auto – Emergency operation**

Example:

If the Unit turns ON the Back-Up heaters or Emergency operation for DHW and the setting on the thermostat is set to 40°C, the heaters will work only until 40°C and then switch OFF regardless of the demand from the main controller. If however the thermostat is set to 60°C, the Main controller will switch OFF the heaters according to its needs (DHW set temperature).

# 11 WIRING

## 11.1 INDOOR UNIT – POWER AND ECO INVERTERS AS

### POWER EVI INVERTER 15,18 AS and ECO INVERTERS 10,13 AS

- AH: Auxiliary Electrical Heater
- HWTBH: Hot Water Tank Back-up Heater
- HBH: Heating Back-up Heater
- KM1: Contactor for AH
- KM2: Contactor for HBH
- KM3: Contactor for HWTBH
- Relay 1: Diverting Valve Relay
- Relay 2: Emergency AH and HWTBH relay
- Relay 3: Emergency HBH and P3 relay
- Relay 4: Emergency P1 and P2 relay
- Relay 5: Emergency PD (and PWM cutoff) relay
- PUMP0: Circulation pump inside Hydrobox
- PUMP1: Heating/Cooling Circuit 1 Circulation Pump
- PUMP2: Heating/Cooling Circuit 2 Circulation Pump
- PUMP3: Sanitary Hot Water System Circulation Pump
- MV1&MV2
- MV1: Mixing valve for Heating/cooling circuit 1, 24V DC power, 0-10V signal
- MV2: Mixing valve for Heating/cooling circuit 2, 24V DC power, 0-10V signal.

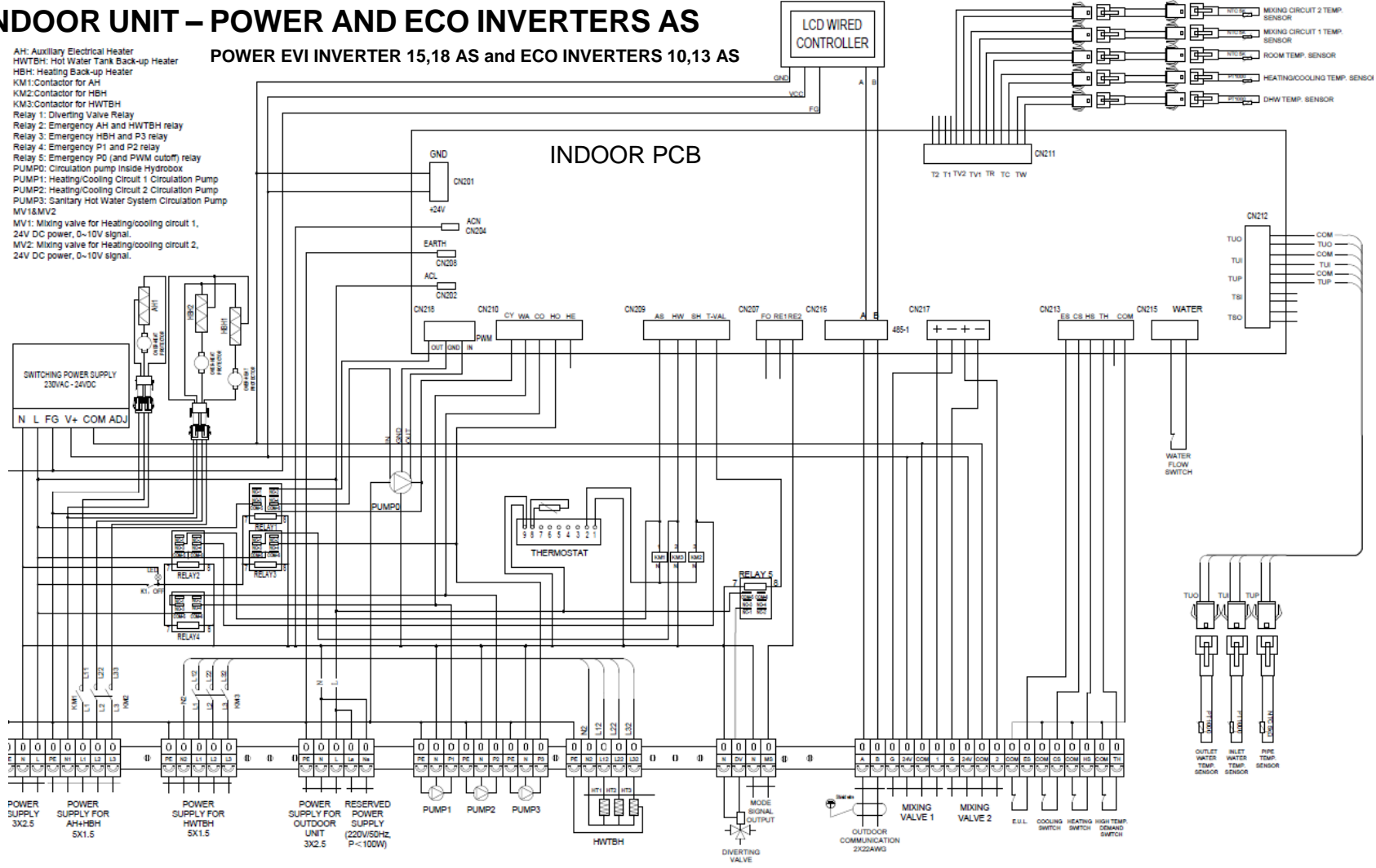

# 11.2 INDOOR UNIT – ALL-IN-ONE INVERTER AS

## WIRING DIAGRAM - Indoor unit ALL-IN-ONE

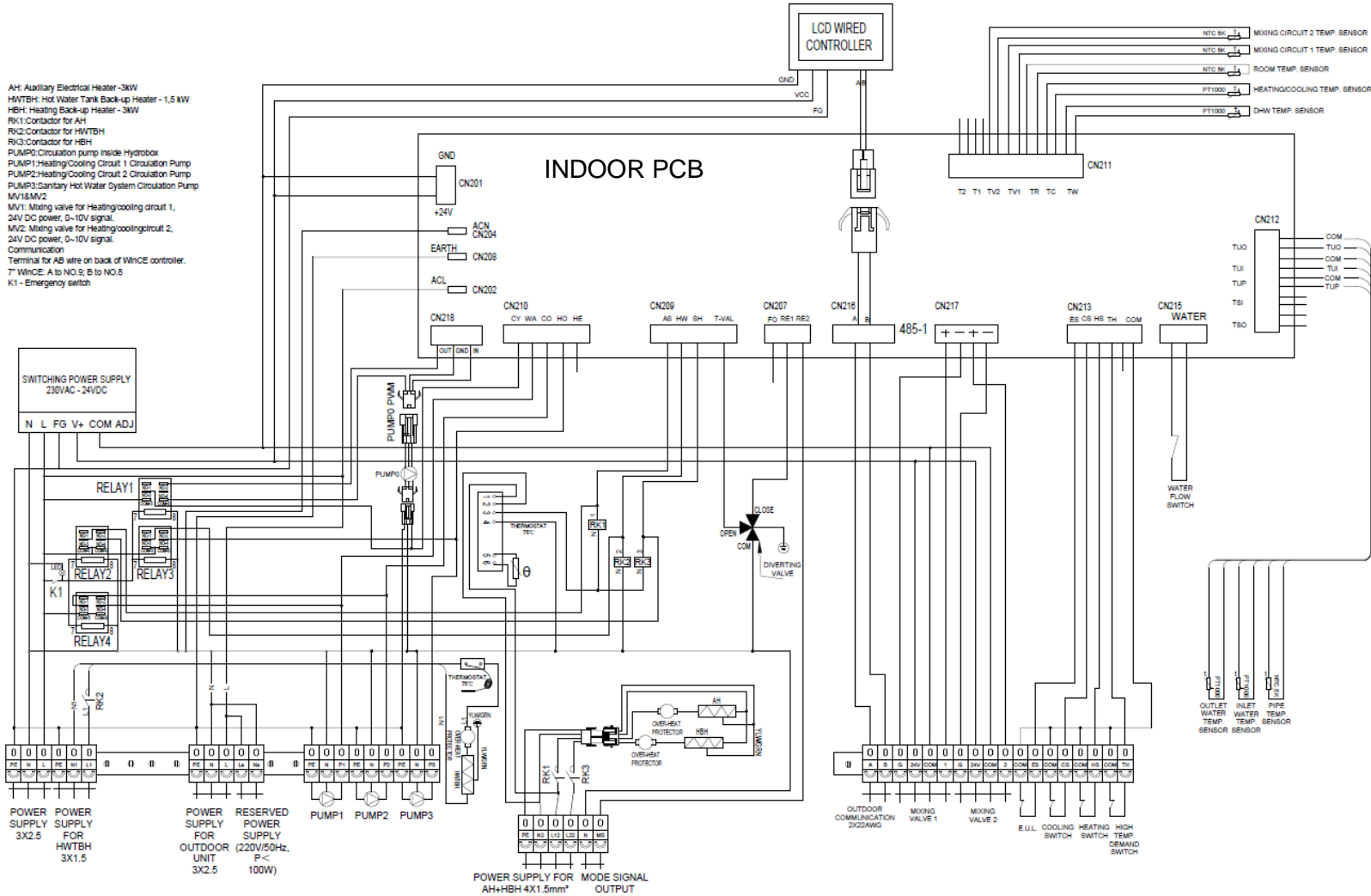

# INDOOR PCB - ALL INVERTERS

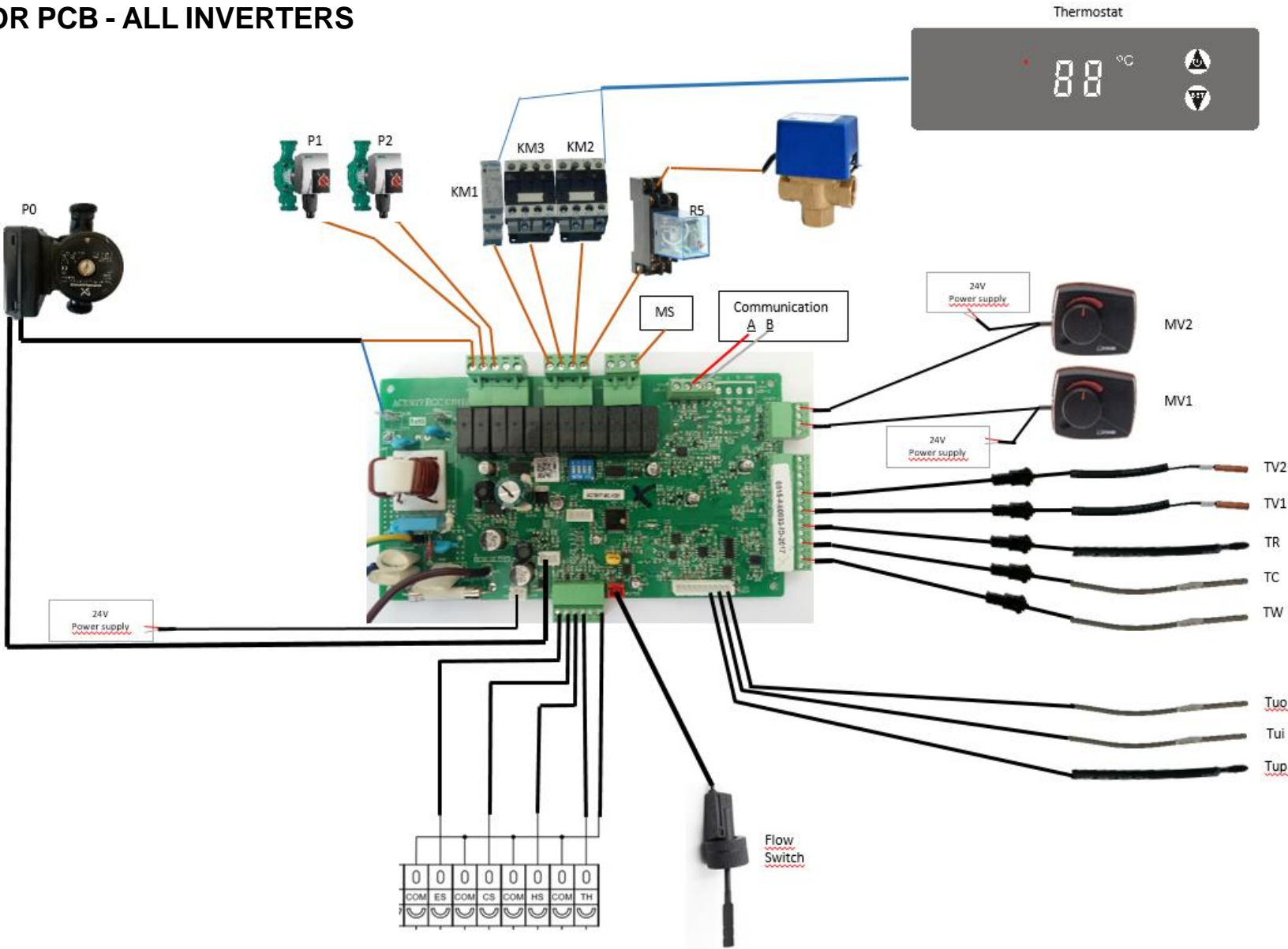

## 11.3 INDOOR UNIT TERMINALS – ECO 10 AS & 13 AS, POWER EVI 15 AS & 18 AS

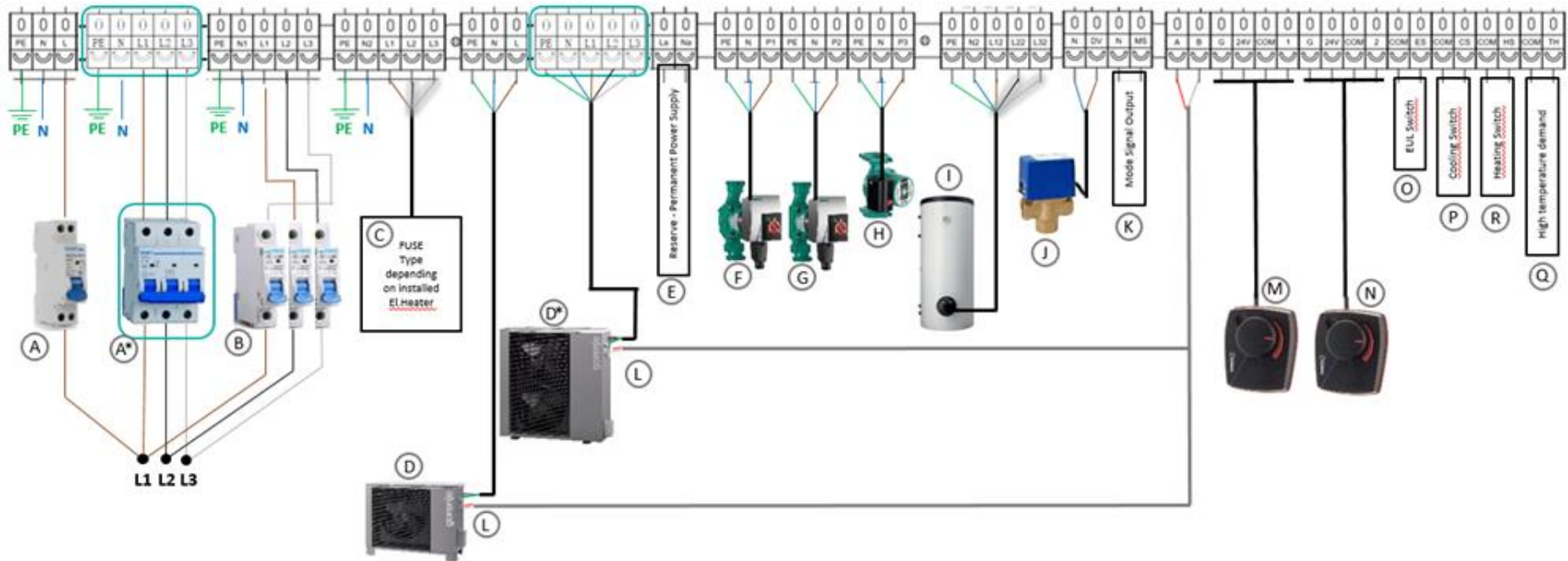

### Marked terminals are for POWER EVI INVERTERS

- |    |  |   |  |
|----|--|---|--|
| A  | HEAT PUMP POWER SUPPLY (FUSE – 20 A 1P C)  | I | ADDITIONAL ELECTRICAL HEATER FOR DHW TANK  |
| A* | HEAT PUMP POWER SUPPLY (FUSE – 16 A 3P C) (POWER EVI INVERTER 15A, 18A)                            | J | DIVERTING VALVE – DHW MODE WITH POWER  |
| B  | INTERNAL ELECTRICAL HEATERS POWER SUPPLY (FUSE – 3x10 A 1P C)                                      | K | MODE SWITCHING SIGNAL  |
| C  | POWER SUPPLY FOR ADDITIONAL ELECTRICAL HEATER FOR DHW TANK – DEPENDING ON THE TYPE                 | L | INDOOR TO OUTDOOR COMMUNICATION<br><i>Cable included in the package – 3x0,75 mm<sup>2</sup> Shielded</i> |
| D  | INDOOR TO OUTDOOR POWER CONNECTION (230 V) – 3x2,5 mm <sup>2</sup>                                 | M | MIXING VALVE 1 (24 V DC Power supply, 0 – 10 V DC Signal)  |
| D* | INDOOR TO OUTDOOR POWER CONNECTION (400 V) – 5x2,5 mm <sup>2</sup> (POWER EVI INVERTER 15 A, 18 A) | N | MIXING VALVE 2 (24 V DC Power supply, 0 – 10 V DC Signal)  |
| E  | CONSTANT 230 V RESERVE – MAX. LOAD 100 W   | O | ELECTRICAL UTILITY LOCK  |
| F  | CIRCULATING PUMP – HEATING CIRCUIT 1   | P | EXTERNAL SWITCH INPUT FOR COOLING MODE (0/1)   |
| G  | CIRCULATING PUMP – HEATING CIRCUIT 2   | R | EXTERNAL SWITCH INPUT FOR HEATING MODE (0/1) (see page 55)   |
| H  | CIRCULATING PUMP FOR DHW (230 V on P3 during DHW operation)  | Q | EXTERNAL SWITCH INPUT FOR HIGH TEMPERATURE DEMAND (0/1)  |

# 11.4 OUTDOOR PCB ECO INVERTER

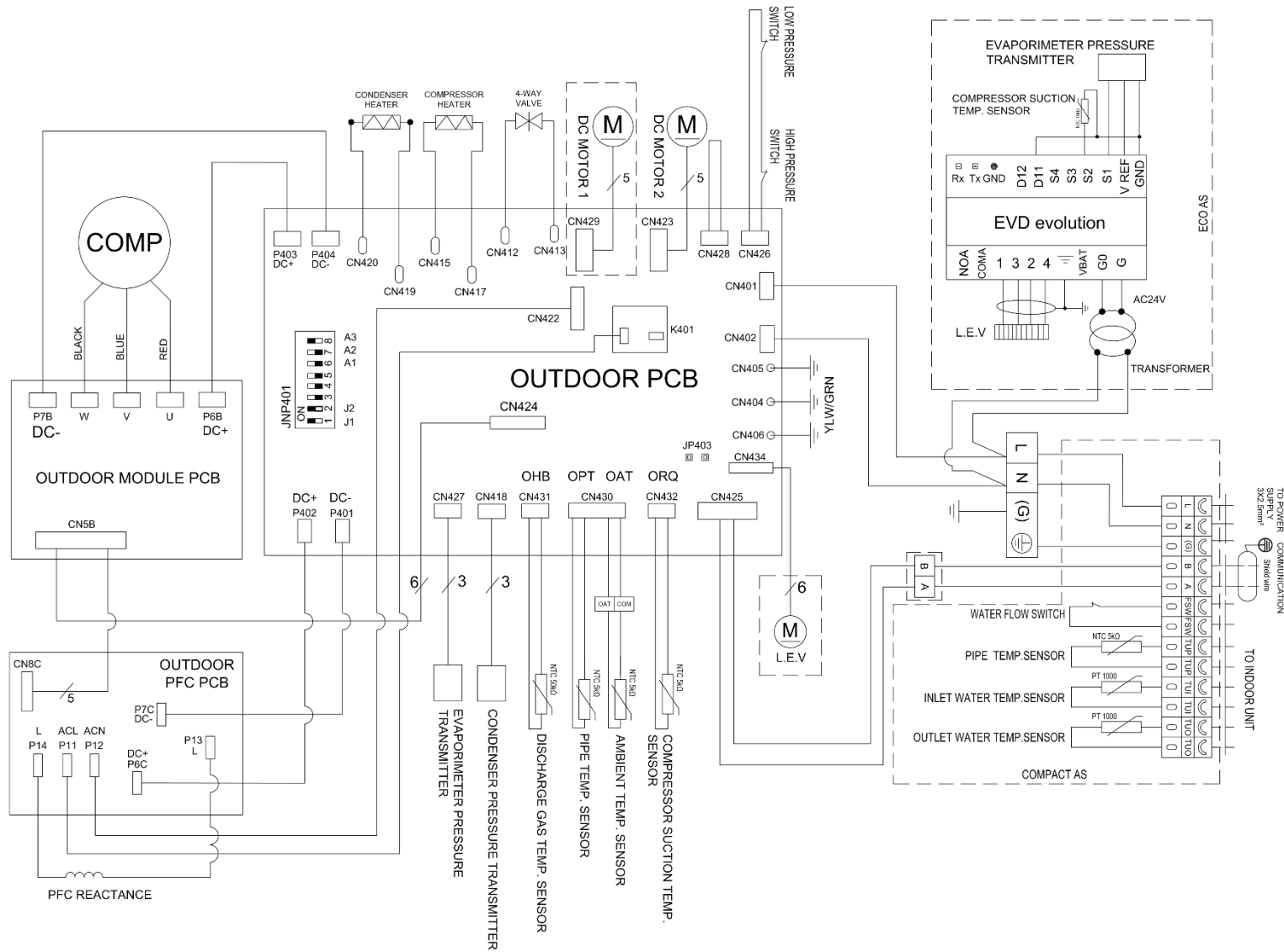

# OUTDOOR PCB ECO INVERTER

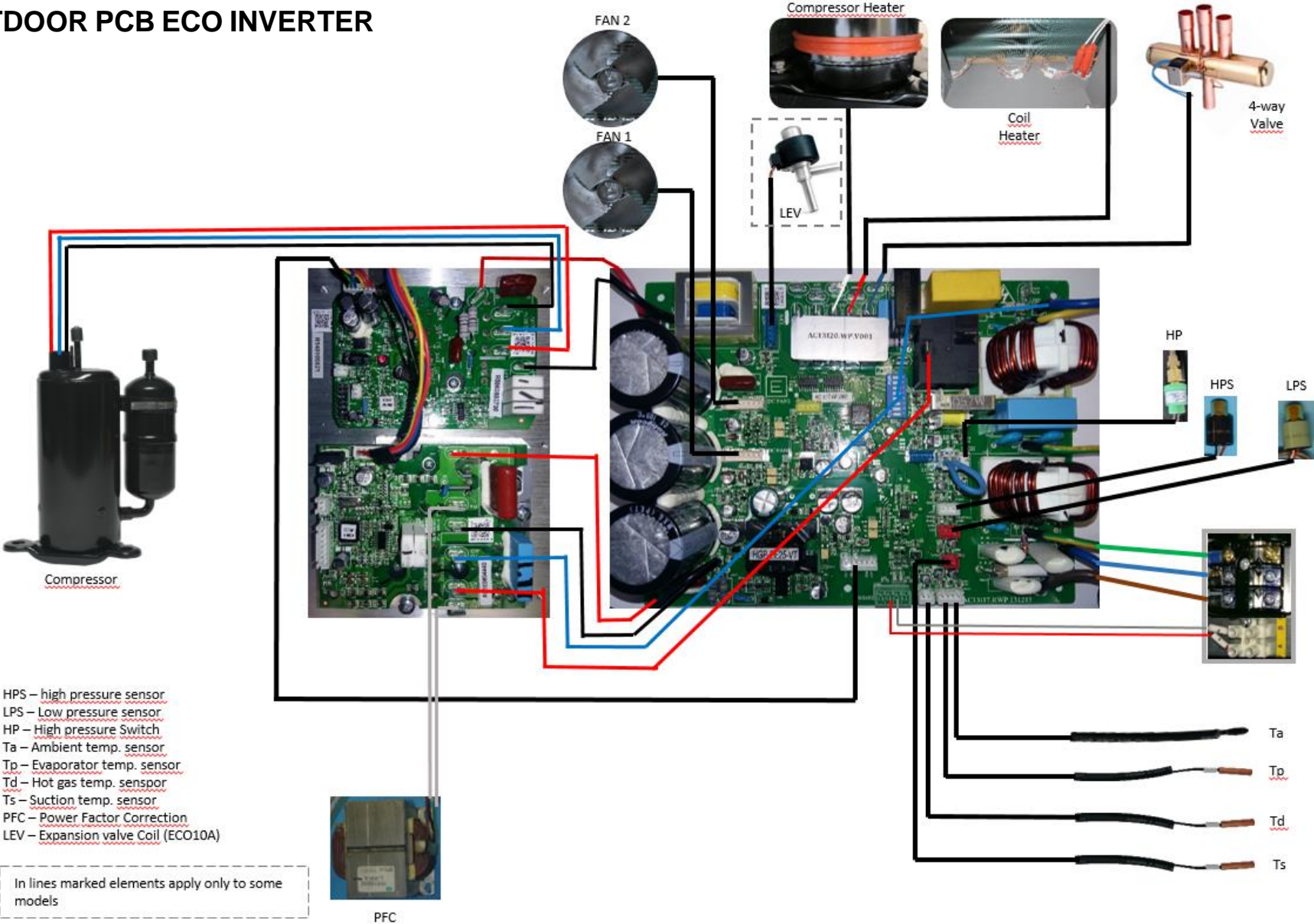



# 11.5DRIVE FOR EEV

## ECO INVERTER 13 AS

Transformer  
230VAC-24VAC

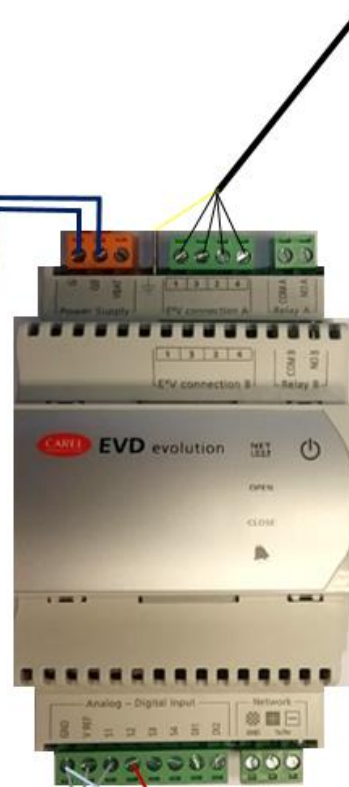

Electronic Expansion Valve



LP sensor



Temperature sensor

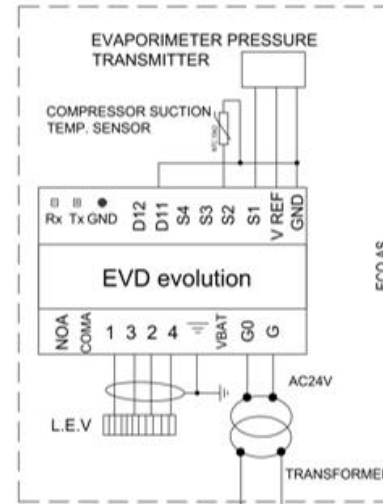

# 11.6 OUTDOOR UNIT – POWER EVI INVERTER 15 AS, 18 AS

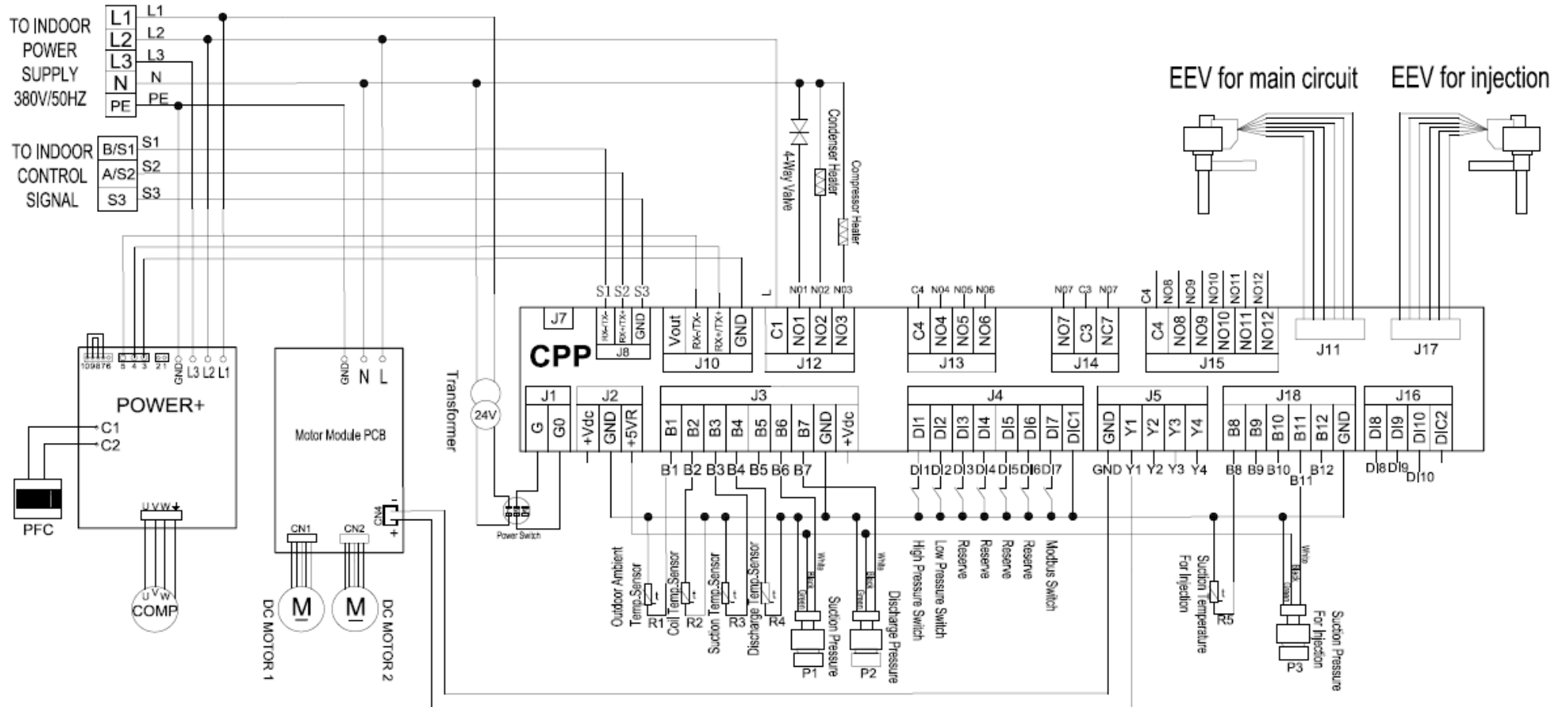

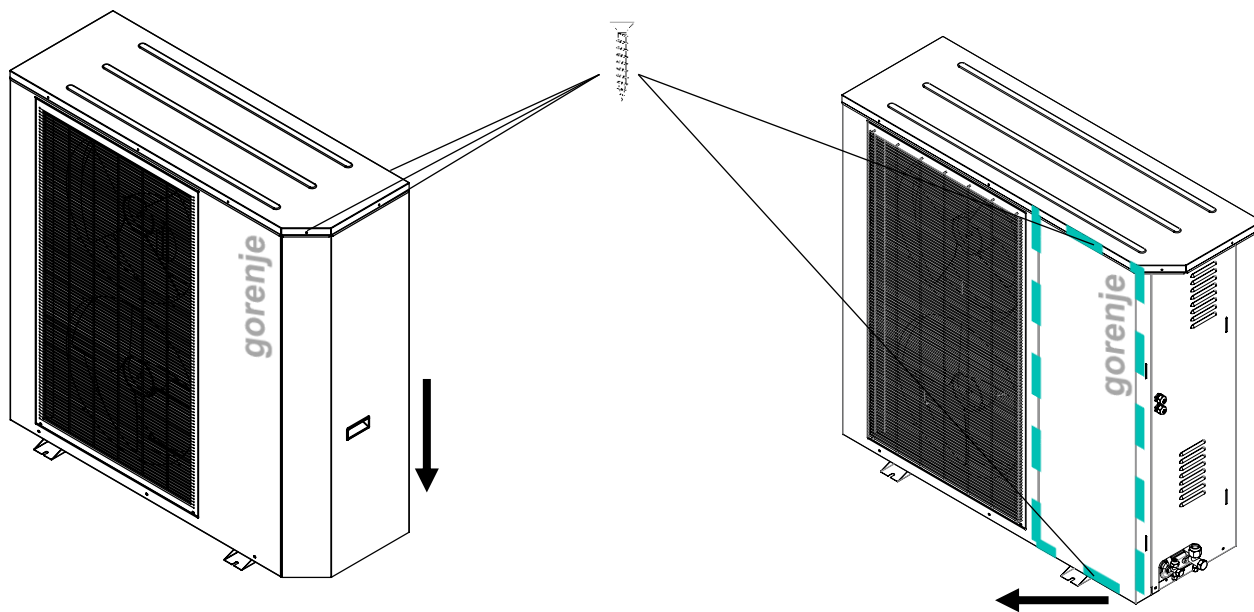

In order to get to the outdoor PCB on Aerogor Power EVI Inverter 15 AS and 18 AS, first unscrew 3 screws and pull down the hatch, which is shown on the left picture. Once the hatch is down, unscrew one screw on the top and bottom and carefully remove the marked hatch on the right picture.

# OUTDOOR UNIT – POWER EVI INVERTER 15 AS, 18 AS

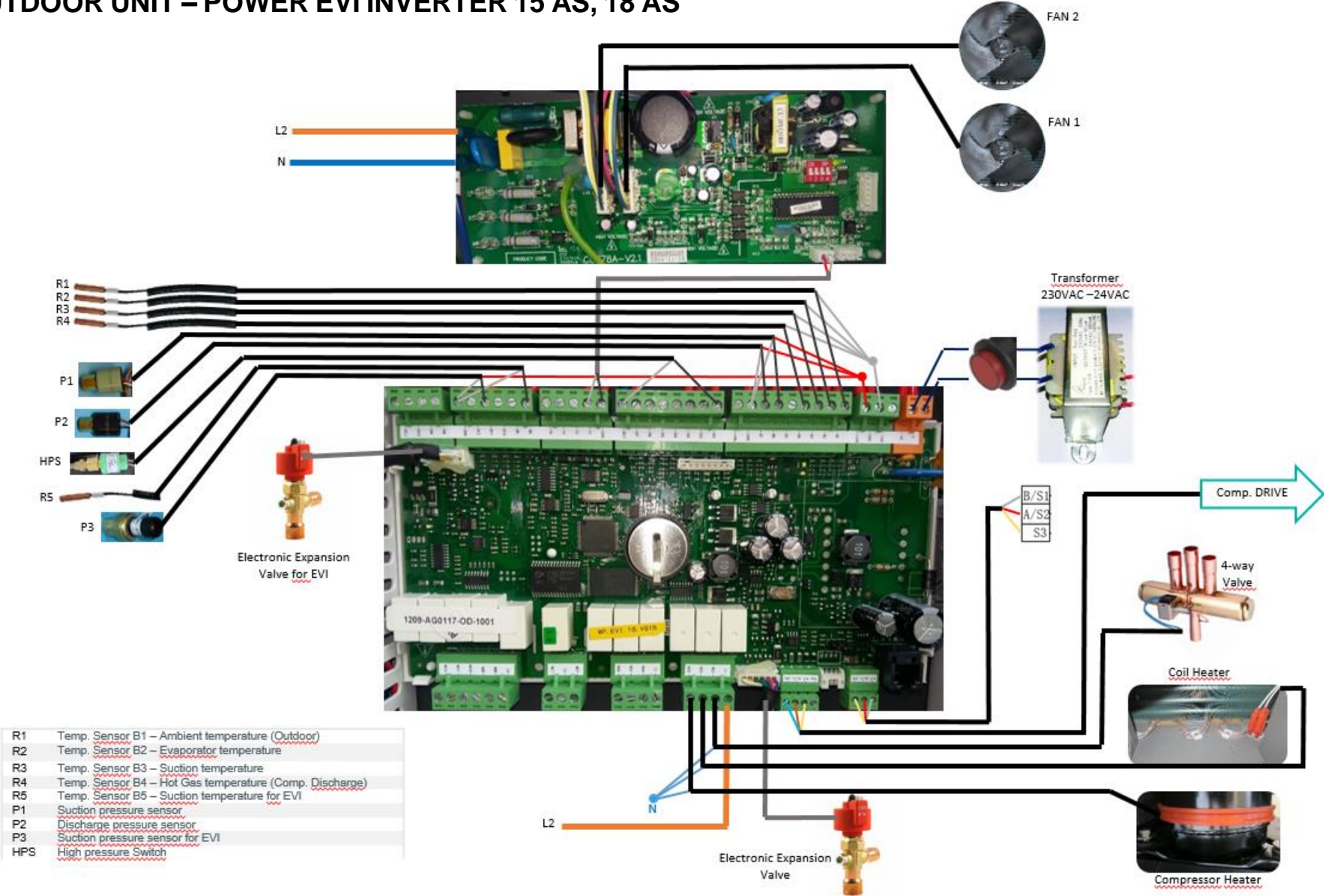

# 11.7 OUTDOOR UNIT DRIVE – AEROGOR POWER EVI 15 AS, 18 AS

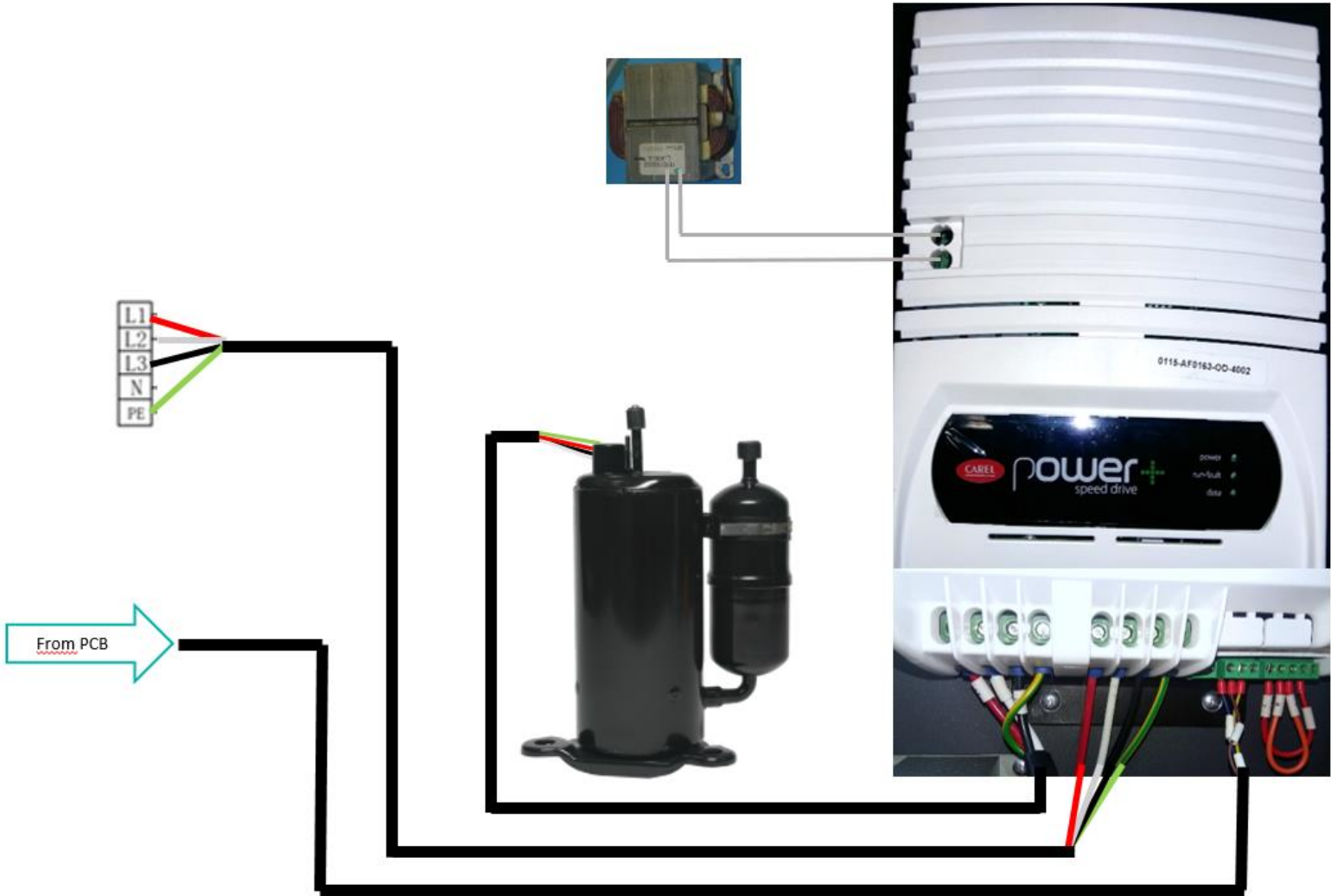

Dear Customer!  
We would like to thank you for reading this manual.  
For more information, feel free to contact us at:  
[hvac@gorenje.com](mailto:hvac@gorenje.com)

Gorenje d.d.  
HVAC  
Partizanska cesta 12 | SI-3503 Velenje  
<http://www.gorenje.com>

WE RESERVE THE RIGHT TO MAKE CHANGES  
THAT DO NOT IMPAIR THE FUNCTIONALITY OF THE DEVICE.