



NAVODILA ZA  
VGRADNJO, UPORABO IN  
VZDRŽEVANJE PEČI

SLO

INSTRUCTIONS FOR USE,  
MAINTENANCE AND  
INSTALLATION

ENG

AQUA ECOLOGIC 15C



# NAVODILA ZA VGRADNJO, UPORABO IN VZDRŽEVANJE PEČI

## NAVODILA ZA VGRADNJO, UPORABO IN VZDRŽEVANJE PEČI

**Kurilne naprave (v nadaljevanju navedene kot "peč na pelete" ali "peč") podjetja Gorenje d.d. (v nadaljevanju Gorenje) so izdelane in preizkušene v skladu z varnostnimi zahtevami veljavnih evropskih direktiv.**

**Ta navodila so namenjena končnim uporabnikom, inštalaterjem in pooblaščenim serviserjem peči na pelete Gorenje, ki je prikazana na naslovni strani tega priročnika za uporabo.**

**V kolikor imate kakršen koli dvom glede navodil za uporabo ali potrebujete kakršno koli pojasnilo vas prosimo, da stopite v stik direktno s proizvajalcem ali pooblaščen osebo podjetja Gorenje d.d. Pri tem vedno navedite številko poglavja, kjer so se pojavile nejasnosti.**

*Tiskanje, prevod ali reprodukcija, četudi le delna, navodil za uporabo je možna le z odobritvijo podjetja Gorenje d.d. Posredovanje tehničnih podatkov, vrednosti in specifikacij iz teh navodil za uporabo tretjim osebam ni dovoljeno.*

### **OPOZORILO:**

**POMEMBNO:** Napravo lahko v električno omrežje priklopi samo ustrezno usposobljena in pooblaščen oseba. Priklop mora biti izveden v skladu z veljavnimi predpisi.

**Ta naprava ni primerna z ljudi (vključno z otroki) z zmanjšanimi telesnimi, motoričnimi ali umskimi sposobnostmi ali osebam z omejenim znanjem in izkušnjami, kadar niso pod nadzorom oseb, ki so odgovorne za njihovo varnost ali nego.**

**Naprava ni igrača. Otrok v bližini naprave ne puščajte brez nadzora.**

### **SISTEM DVOJNEGA ZGOREVANJA**

Plamen, ki nastane pri pravilnem izgorevanju lesne biomase znotraj peči, odda enako količino ogljikovega dioksida (CO<sub>2</sub>), kot bi bilo izpuščenega pri naravni dekompoziciji lesa.

Količina CO<sub>2</sub>, proizvedena pri izgorevanju ali dekompoziciji lesa, odgovarja količini CO<sub>2</sub>, ki ga drevo pridobi iz okolja v njegovem življenjskem obdobju ter ga nato spremeni v kisik in ogljik.

V nasprotju z izkoriščanjem lesa, pa se pri uporabi neobnovljivih virov energije (ogljje, kurilno olje, plin) v zrak sproščajo ogromne količine CO<sub>2</sub>, ki se nabira skozi milijone let in povečuje toplogredne pline. Uporaba lesa kot goriva je popolnoma uravnotežena z okoljem, saj je les kot obnovljiv vir v ekološkem sožitju z naravo.

Načelo čistega izgorevanja v popolnosti zadošča vsem okoljevarstvenim zahtevam, podjetje Gorenje d.d. pa je osnovalo ves lasten razvoj na tej osnovi.

Kaj razumemo kot pravilno izgorevanje in kako deluje?

Nadziranje in prilagajanje primarnega zraka ter dovajanje sekundarnega zraka povzroči sekundarno zgorevanje. To poskrbi za sekundarni plamen, ki je po naravi svetlejši in močnejši kot primarni plamen. Dovajanje novega kisika (preko dodajanja zraka) omogoča nadaljnje zgorevanje plinov, ki niso popolnoma zgoreli. Na ta način pride do občutnega povečanja toplotne učinkovitosti in zmanjšanja škodljivih izpustov ogljikovega monoksida (CO), saj se zmanjša tudi delež nepravilnega izgorevanja. To so osnovne značilnosti, ki odlikujejo kotle na pelete in druge izdelke podjetja Gorenje.

## KAZALO

1	OPOZORILA .....	1
1	TEHNIČNI PODATKI.....	4
1.1	DIMENZIJE PEČI.....	5
2	NAMEN NAVODIL ZA UPORABO.....	6
2.1	POSODOBITVE .....	6
3	ODGOVORNOST PROIZVAJALCA.....	6
3.1	SPLOŠNI POGOJI ZA UPORABO.....	6
3.2	OSNOVNI PREVENTIVNO ZAHTEVANI STANDARDI .....	7
3.3	PREVOZ IN PREMIKANJE PEČI NA PELETE.....	7
3.4	ODGOVORNOST INŠTALATERJA.....	7
4	VGRADNJA PEČI .....	9
4.1	POSTAVITEV.....	9
4.2	ODVOD DIMNIH PLINOV .....	12
4.3	IZOLACIJA IN PREMER LUKENJ NA STREHI .....	14
4.4	DOVODNI ZRAK.....	14
4.5	ELEKTRIČNA VEZAVA.....	15
5	PRVI ZAGON KOTLA.....	16
6	VARNOSTNA OPOZORILA .....	17
6.1	VARNOSTNA OPOZORILA ZA SERVISERJE.....	17
6.2	VARNOSTNA OPOZORILA ZA UPORABNIKA.....	17
7	NAVODILA ZA VAREN VŽIG KOTLA TER VARNO ČIŠČENJE.....	18
7.1	REDNO VZDRŽEVANJE IN ČIŠČENJE KOTLA .....	18
7.2	KONTROLA IN DELI, POTREBNI VZDRŽEVANJA.....	20
7.3	DODATNO VZDRŽEVANJE.....	20
8	POMEMBNI VARNOSTNI PODATKI.....	21
9	KVALITETA PELET JE ZELO POMEMBNA.....	21
9.1	SKLADIŠČENJE PELET .....	21
10	OPIS IN DELOVANJE KRMILNE NAPRAVE .....	22
10.1	OPIS TIPKOVNICE S PRIKAZOVALNIKOM.....	22
10.2	KOTEL MED DELOVANJEM .....	24
10.3	ZAUSTAVITEV KOTLA .....	25
10.4	VKLOP KOTLA .....	25
10.5	NASTAVITEV ČASOVNEGA PROGRAMA.....	26
10.6	NAPISI IN SPOROČILA NA PRIKAZOVALNIKU.....	27
11	MENIJI.....	29
12	ALARMNA STANJA.....	30

13	INFORMACIJE ZA UNIČENJE IN ODSTRANITEV KOTLA .....	37
14	TRAJANJE GARANCIJSKE DOBE.....	38
14.1	GARANCIJSKI POGOJI .....	38
15	NAVODILA ZA PRVI ZAGON .....	40

# 1 OPOZORILA

---

## POZOR

Odvod dimnih plinov **NE SME BITI PRIKLOPLJEN NA:**

- izpušno cev, ki jo uporabljajo druge kurilne naprave (kotli, peči, kamini itn.);
  - odzračevalne sisteme (kape, odzračevalni ventilatorji, itn.).
- 

## POZOR

Prepovedano je vgraditi zaporne ventile vleka!

Dimniški priključek Ø 80 mm iz kotla na pelete do dimnika naj bo:

- dolg največ 5 m (v primeru daljšega priključka naj se poveča dimenzija priključne cevi na Ø 130 mm) ;
  - vsako koleno pod kotom 90° zahteva 1 m krajši dimniški priključek;
  - vsako koleno mora biti opremljeno s čistilnimi vratci;
  - spoji med priključnimi cevmi morajo biti zatesnjeni.
- 

## POZOR

Če v izpušnem sistemu prihaja do prevelikega upora (številna kolena, neustrezni končniki, ozka grla, itn.), odvod dimnih plinov ni zagotovljen, zato je potrebno povečati priključne cevi in kolena na večjo dimenzijo in sicer na Ø130 mm. Enako v primeru, kjer dimnik ne omogoča pravilnega odvoda dimnih plinov, lahko prihaja do nepravilnega delovanja in posledično do alarmiranja kotla. Priporočljivo je, da se dimnik pregleda s strani strokovne osebe pred montažo kotla.

---

## POZOR

Nikoli ne izklaplajte kotla tako, da izvlečete električni kabel iz vtičnice, dokler v kotlu še gori ogenj. To lahko poškoduje kotel in resno ogrozi njegovo pravilno delovanje.

---

## POZOR

Izpust dimnih plinov mora imeti ozemljitev v skladu z veljavnimi predpisi. (Ozemljitvena vezava je zakonsko določena). Ozemljitev mora biti neodvisna od kurilne enote.

---

---

**! POZOR**

Po končani vgradnji kotla obvezno opravite meritve izpusta dimnih plinov.

---

**! POZOR**

Kotel na pelete deluje tako, da v izgorevalni komori ustvari podtlak, zato se prepričajte, da je izpust dimnih plinov termično zatesnjen. Pri prvem zagonu (minimalno 1 uro delovanja kotla) se iz barve izločijo hlapi, ki so neprijetnega vonja, zato prostor prezračite.

---

**! POZOR**

**MED DELOVANJEM KOTLA NA PELETE OTROCI NE SMEJO V NJEGOVO BLIŽINO IN SE Z NJIM IGRATI!**

---

**! POZOR**

Pazite na tesnilno vrstico pod robom kurilne posode, da ni poškodovana. V primeru, da je tesnilna vrstica poškodovana, se obrnite na pooblaščen servis.

---

**! POZOR**

Pred čiščenjem se prepričajte, da sta kotel na pelete in pepel v njem hladna! Odklopite električno napajanje!

---

**! POZOR**

V primeru, da pride do pojava ognja v dimniku je nujno, da ljudje in živali zapustijo prostor. Takoj zatem je potrebno prekiniti električno napeljavo preko glavnega stikala ali vtičnice (seveda če to lahko storite brez kakršnega koli tveganja) in poklicati gasilce.

---

**! POZOR**

Zaradi samega delovanja in varnosti kotla na pelete ne smete uporabljati drobno nasekanih drv.

---

**! POZOR**

Ne uporabljajte kotla na pelete kot sežigalca.

---

**! POZOR**

Osebe z okvaro hrbtenice in nosečnice naj se dvigovanja vreč s peleti izogibajo.

---



---

**! POZOR**

Proizvajalec ni v nobenem primeru odgovoren za škodo pri uporabi pelet slabe kvalitete, kot tudi ne za slabo delovanje kotla zaradi slabe kvalitete uporabljenih pelet.

---

**! POZOR**

Peleti naj bodo skladni z DIN 51731, DIN plus, Ö-Norm M-7135 ali drugimi primerljivimi evropskimi standardi.

---

**! POZOR**

PELETI NE SMEJO BITI SHRANJENI V BLIŽINI KOTLA NA PELETE. Hranite jih vsaj 1/2 metra stran.

---

**! POZOR**

ZAVRZITE VES PAKIRNI MATERIAL DALEČ OD DOSEGA OTROK. OBSTAJA NEVARNOST ZADUŠITVE Z VREČO, FOLIJO, POLISTIRENOM, ITN.

---

# 1 TEHNIČNI PODATKI

	Minimalna	Nazivna
Termična moč	4,97 kW	17,13 kW
Izkoristek	90,6 %	93,83 %
Poraba pelet na uro	1,13 kg/h	3,77 kg/h
Čas gorenja z 1 polnjenjem zalogovnika (cca)	39,8 h	12 h
Emisije CO (pri 10% O <sub>2</sub> )	136 mg/Nm <sup>3</sup>	56 mg/Nm <sup>3</sup>
Povprečna temperatura dimnih plinov	58 °C	117,1 °C
Masni pretok dimnih plinov	3,9 g/s	8,4 g/s
Gorivo	Peleti A1	
Razred kotla po EN 303-5:2012	5	
Dimniški priključek	Ø 80 mm	
Količina vode v kotlu	42 l	
Temperatura kotlovske vode	65 °C – 80 °C	
Najvišja temperatura kotlovske vode	90 °C	
Minimalna temperatura povratne vode	50 °C	
Največji dovoljeni delovni pritisk	2,5 bar	
Odpornost kotla ΔT=20°C	32 mbar	
Volumen kurišča	30,6 l	
Teža	220 kg	
Zalogovnik za pelete	~ 55 Kg	
Vlek dimnika	0,10 (± 0,05) mbar	
Napajanje	220 V	
Tok pri največji porabi el. energije pri delovanju kotla	1,80 A	
Frekvenca	50 Hz	
Največja poraba el. energije pri delovanju kotla	98,91 W	
Največja poraba el. energije pri vžigu kotla	293 W	
Stopnja varnosti	IP20	
Kotel deluje z dvema ventilatorjema		

Kotel deluje po načinu podtlačnega izgorevanja

Kotel deluje brez pogojev kondenzacije

Hrup ne presega 60 dB

Emisije CO pri 13% O<sub>2</sub> 56 mg/N<sub>m</sub><sup>3</sup>

Emisije OGC pri 13% O<sub>2</sub> 2,6 mg/N<sub>m</sub><sup>3</sup>

Pepel pri 13% O<sub>2</sub> 17,3 mg/N<sub>m</sub><sup>3</sup>

## 1.1 DIMENZIJE PEČI

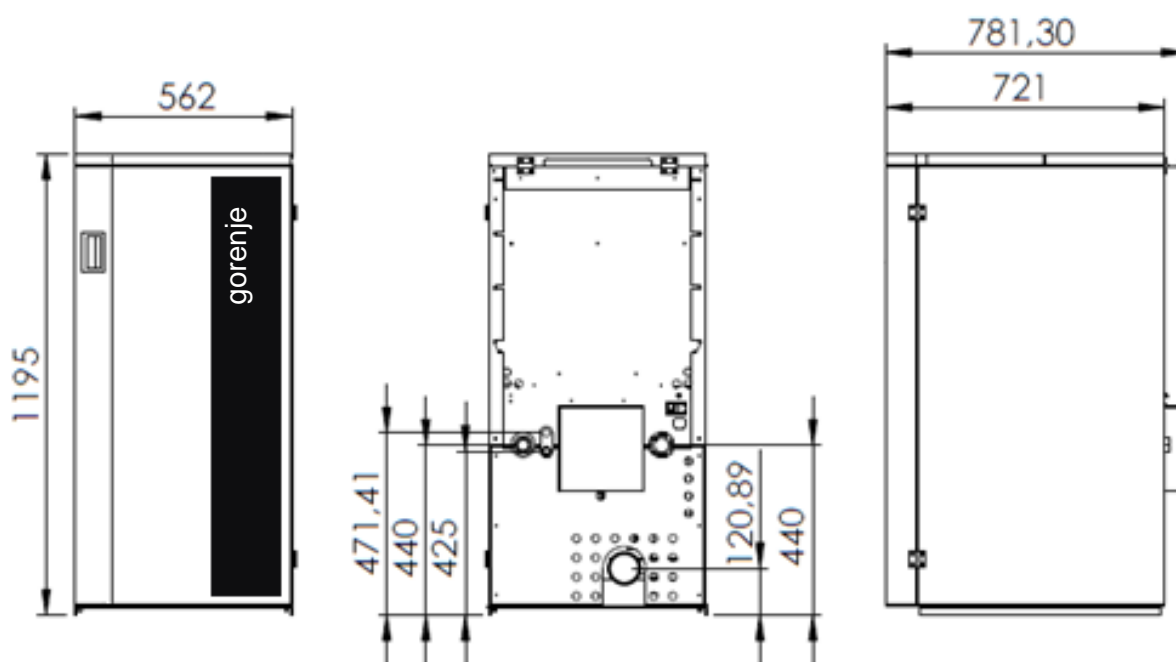

## 2 NAMEN NAVODIL ZA UPORABO

---

Namen navodil za uporabo je, da uporabnik podvzame vse potrebne ukrepe in da pripravi vso potrebno opremo, da bi zagotovil varno in pravilno uporabo kurilne naprave.

### 2.1 POSODOBITVE

Ta navodila odražajo stanje tehnike izdelka v trenutku, ko je bila peč izdelana. Navodila niso merodajna za izdelke, ki so že na trgu z odgovarjajočo tehnično dokumentacijo in jih ni mogoče smatrati kot pomanjkljiva ali nezadostna, po vsaki spremembi, adaptaciji ali aplikaciji novih tehnologij na novejših izdelkih.

Vsebino te knjižice morate pazljivo prebrati in upoštevati. Vse informacije, ki jih ta knjižica vsebuje, so potrebne za pravilno vgradnjo, uporabo in vzdrževanje vaše peči.

Navodila naj bodo pazljivo in varno shranjena, če jih boste morda še potrebovali v primeru dvomov ali težav.

*V primeru, da postane lastnik peči druga oseba, mu je potrebno izročiti skupaj s pečjo tudi ta navodila za uporabo.*

Če se navodila izgubijo, lahko prosite za novo kopijo navodil proizvajalca, pooblaščenega prodajalca ali serviserja.

## 3 ODGOVORNOST PROIZVAJALCA

---

Z dobavo teh navodil Gorenje zavrača vsakršno civilno ali kazensko povezavo, tako direktno kot indirektno zaradi:

- nezgode, nastale zaradi neizpolnjevanja standardov in specifikacij iz teh navodil;
- nezgode, nastale zaradi nedovoljene in nepravilne uporabe s strani uporabnika;
- nezgode, nastale zaradi sprememb in popravil, ki jih ni odobril proizvajalec Gorenje d.d.;
- slabega vzdrževanja;
- nepredvidenih situacij;
- nezgod, nastalih zaradi uporabe neoriginalnih ali neustreznih rezervnih delov.

Za vgradnjo je v celoti odgovoren inštalater.

### 3.1 SPLOŠNI POGOJI ZA UPORABO

Peč na pelete lahko uporabljajo le odrasle (polnoletne) in odgovorne osebe, ki posedujejo potrebno tehnično znanje za predpisano redno vzdrževanje električnih in mehanskih delov peči.

**OTROK NE PUŠČAJTE BREZ NADZORA V BLIŽINI DELUJOČE PEČI. PEČ NI IGRAČA.**

## 3.2 OSNOVNI PREVENTIVNO ZAHTEVANI STANDARDI

Izdelek Gorenje Aqua Ecologic 15C je izdelan skladno s sledečimi standardi:

- DIREKTIVA ES O STROJIH (2006/42/CE);
- DIREKTIVA ES O NIZKONAPETOSTNI OPREMI (2014/35/ES);
- DIREKTIVA ES O ELEKTROMAGNETNI ZDRUŽLJIVOSTI (2014/30/ES);

Harmonizirani standardi:

- EN 303-5:2012
- EN 60335-1:2012+A11:2014
- EN 6100-6-3:2007+A1:2011
- EN ISO 12100:2010
- EN 60335-2-102:2006+A1:2010
- EN 60204-1:2006+A1:2009
- EN 60529:1992+A2:2013

## 3.3 PREVOZ IN PREMIKANJE PEČI NA PELETE

Med premikanjem in uporabo peči bodite previdni in pazite, da se peč ne nagne naprej, saj ima težišče na sprednjem delu.

Pred prevozom in premikanjem peči, ki mora potekati v popolni varnosti, se najprej prepričajte, da je nosilnost transportne opreme primerna. Izogibajte se sunkovitim in/ali nenadnim premikom peči.

ZAVRZITE VES PAKIRNI MATERIAL DALEČ OD DOSEGA OTROK. OBSTAJA NEVARNOST ZADUŠITVE S PLASTIČNO VREČKO, FOLIJO, POLISTIRENOM, ITD.

## 3.4 ODGOVORNOST INŠTALATERJA

**Odgovornost inštalaterja** je, da preveri primernost instalacije in cevovoda, zagotovi dovod zraka za potrebe gorenja in vseh ostalih, potrebnih rešitev, ki jih zahteva vgradnja peči na pelete.

**Odgovornost inštalaterja** je, da zagotovi skladnost z veljavno lokalno zakonodajo tam, kjer je peč na pelete vgrajena.

**Uporaba kotla na pelete** mora ustrezati navodilom, navedenim v Navodilih za uporabo, vzdrževanje in vgradnjo, in vsem varnostnim standardom specificiranih v lokalni zakonodaji, kjer je kotel na pelete vgrajen.

Standard UNI 10683 določa dolžnosti inštalaterja. Inštalater mora preveriti:

- vrsto naprave, ki jo bo vgradil;
- ustreznost prostora za vgradnjo enote, ki se odraža z minimalno zahtevano velikostjo prostora, kjer bo peč na pelete vgrajena;
- toplotni generator;
- notranji premer dimnika, iz kakšnega materiala je narejen, ali je raven oz. enakomeren,

- da dimnik ne vsebuje obstrukcij;
- višino in po potrebi vertikalno podaljšanje dimnika;
- višino na mestu vgradnje peči;
- obstoj in primernost odpornosti dimniškega pokrova;
- možnost dovoda zunanjega zraka in velikost potrebnih odprtin;
- možnost simultane uporabe peči z ostalo opremo, ki je že nameščena.

Če so rezultati vseh zgoraj naštetih preverjanj pozitivni, se lahko prične z vgradnjo. Pazljivo upoštevajte navodila, ki vam jih je zagotovil proizvajalec, kot tudi veljavne varnostne in protipožarne standarde.

Ko je opravljen prvi zažog peči, je potrebno izvesti najmanj 30 minutni preizkus delovanja, da bi preverili, ali peč pravilno deluje.

Ko je vgradnja končana, mora inštalater zagotoviti kupcu sledeče:

- navodila za uporabo, vzdrževanje in vgradnjo od proizvajalca (če niso že del enote);
- zahtevano dokumentacijo v skladu z veljavnimi standardi. ;
- opraviti izobraževanje stranke za upravljanje in redno vzdrževanje in čiščenje naprave.

## 4 VGRADNJA PEČI

---

### **Odgovornost za vgradna dela, ki so izvedena v prostoru, je izključno kupčeva.**

Preden prične z vgradnjo, mora inštalater preveriti vse potrebne zakonske varnostne standarde, še posebej:

- preveriti, da norme glede vgradnje kotlov na pelete zadostujejo lokalnim, nacionalnim in evropskim normam;
- upoštevati zahteve iz tega dokumenta;
- preveriti, da so cevi in dovod zraka v skladu s tipom vgradnje;
- ne izvesti začasnih električnih povezav in pri tem uporabiti neprimernih kablov;
- preveriti ozemljitev električnega sistema;
- vedno uporabiti individualno varnostno opremo in vse zakonsko zahtevane zaščite;
- vedno pustiti dovolj prostora za vzdrževalna dela;
- za priključitev kotla na dimnik, je potrebno pridobiti dimnikarsko soglasje;
- po končani vgradnji opraviti meritev izpusta dimnih plinov.

### **4.1 POSTAVITEV**

Priporočljivo je, da embalažo kotla na pelete odstranite takrat, ko se le-ta nahaja na mestu vgradnje, kjer bo tudi vgrajen.

Če so sosednje stene in/ali tla iz materiala, ki ni odporen na toploto, je potrebno zagotoviti primerno zaščito ter uporabiti izolacijo iz negorljivega materiala.

Za zaščito tal, ki so iz gorljivega materiala, vam svetujemo, da pod kotel namestite kovinsko ploščo debeline 3 do 4 mm, ki na sprednji strani za vsaj 30 cm presega globino kotla.

Kotel na pelete naj bo vgrajen skladno s skico, ki opredeljuje odmike od zidov (**Slika 1**).

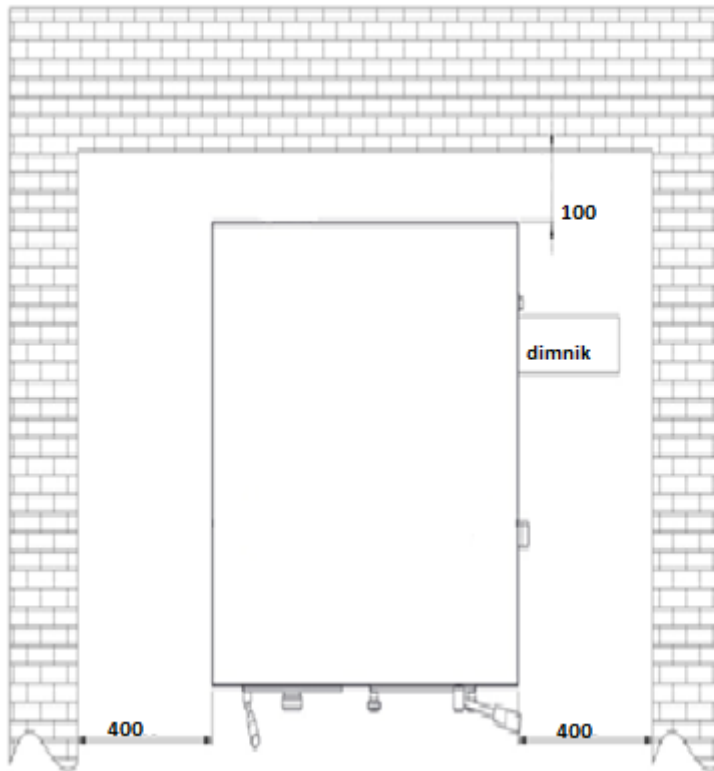

PRIMER 1

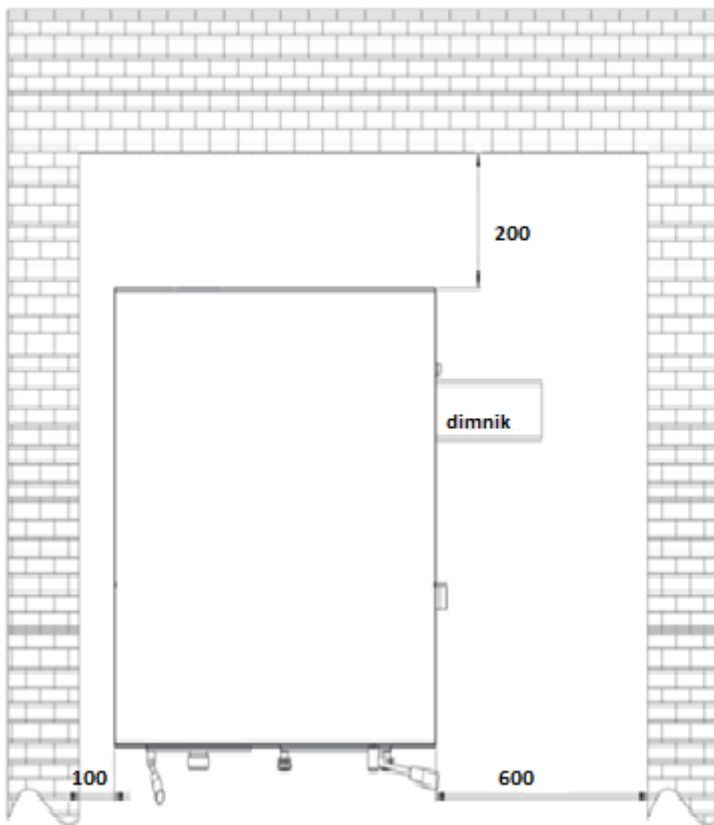

PRIMER 2



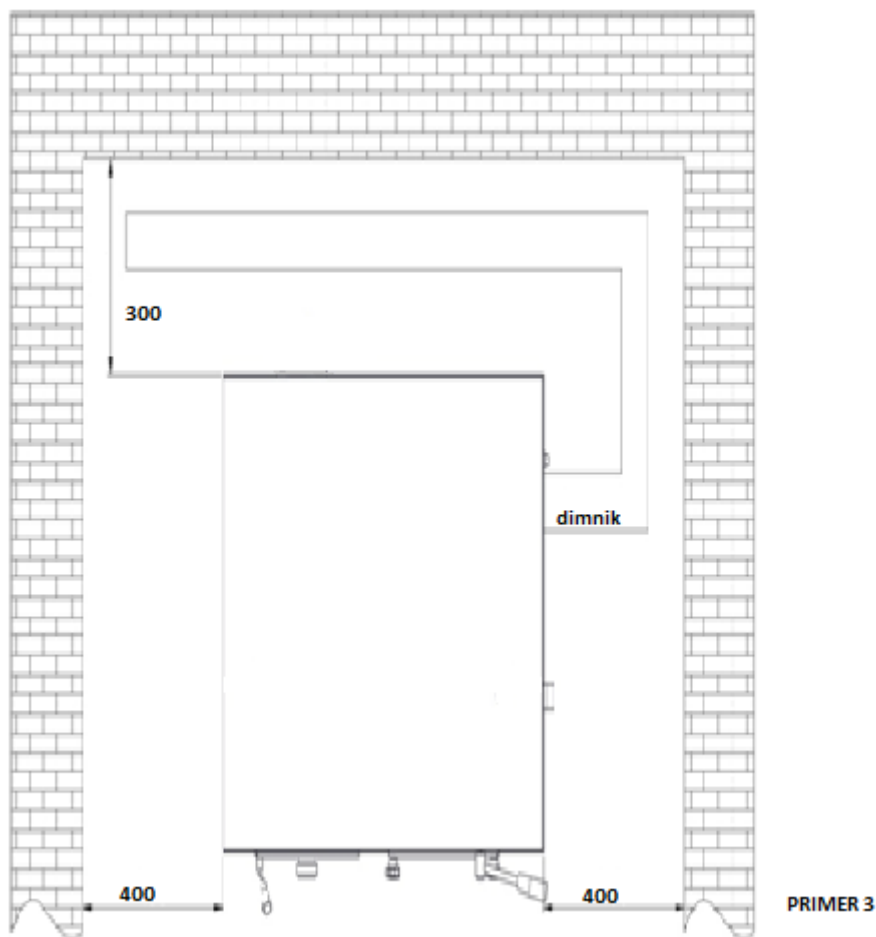

**Slika 1: Minimalni odmiki kotla od sten kotlovnice**

Če je kotel na pelete vgrajen v kurilnici, kjer se že nahajajo naprave, ki odsesavajo zrak (drugi kotli, razni sesalni ventilatorji, itn.) se prepričajte, da je volumen dovodnega zraka dovolj velik za varno delovanje kurilne naprave. Če gre dimni kanal skozi strop, mora biti le-ta primerno izoliran z diafragma iz negorljivega izolacijskega materiala.

Ko je kotel na pelete postavljen, ga je potrebno uravnesiti s podpornimi tačkami (postaviti v vodoraven položaj).

Sistem odvoda dimnih plinov iz kotla na pelete deluje na osnovi podtlaka v kotlu in komaj zaznavnega tlaka v dimni priključni cevi Ø80 mm. Zelo pomembno je, da je odvod dimnih plinov zatesnjen. Potrebno je analizirati razporeditev in strukturo prostora, kjer se nahaja dimnik. V primeru, da gre le-ta skozi zid in/ali streho, mora biti pravilno vgrajen v skladu s standardi požarne varnosti. Zagotovite, da je v prostoru, kjer je kotel na pelete vgrajen, dovolj zraka, potrebnega za pravilno izgorevanje. V kolikor se zgodi, da kotlu primanjkuje kisika-zraka, se bo na kotlu pojavil alarm. Za zunanji odvzem oz. dovod zunanjega zraka potrebujete cev premera vsaj 110 mm in maksimalne dolžine 10 m. Za vsako koleno pod kotom 90° je potrebno odbiti 1 m linije. V kolikor je zajem zraka daljši, je potrebno povečati presek cevi za dovod zraka. V primeru rešetke na fasadi, mora biti odprtina vleka 100 cm<sup>2</sup> oziroma večja.

Naprava deluje na 220 V-50 Hz. Prepričajte se, da se električni kabli ne nahajajo pod kotlom, da so daleč stran od vročih površin in da se ne dotikajo ostrih delov, ki jih lahko poškodujejo. Če je kotel na pelete pod preveliko napetostjo, je življenjska doba električnih komponent veliko krajša.

## 4.2 ODVOD DIMNIH PLINOV

Odvod dimnih plinov mora biti v skladu z veljavnimi predpisi. Cevi dimnih plinov naj ne bodo povezane skupaj z drugimi odvodnimi cevmi katere koli druge kurilne naprave (**Slika 2**). Ni dovoljeno, da se izpust dimnih plinov spelje v zaprte in/ali polzaprte prostore, kot npr. garaža, ozki prehodi ali hodniki, podhodi ali kateri koli drugi podobni prostori. Če dimniški priključek ni ustrezen, ga je potrebno izvesti skladno s predhodno opisanimi zahtevami (točka 3.1).

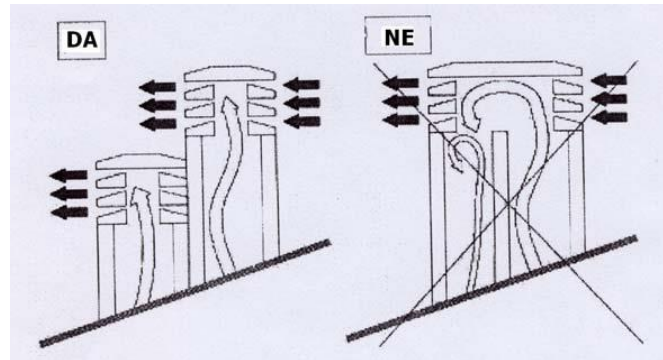

**Slika 2**

Kar se tiče dimenzij ter materiala, iz katerega je izdelan, mora biti dimnik v skladu s standardi UNI 9615-9731, UNI 10683 - EN1856-1.

Dimniki, ki so v slabem stanju in/ali so izdelani iz neprimerne materiala (azbest, pocinkana pločevina itn., s hrapavo ali porozno površino) so v neskladju z zakonom in ogrožajo delovanje kotla.

Dim se lahko odvaja preko tradicionalnega dimnika (glej sliko spodaj) pod pogojem, da so upoštevana naslednja pravila:

- preveriti stanje vzdrževanja dimnika. Za pravilno vzdrževanje in/ali obnovo se obrnite na dimnikarsko službo;
- odvod dimnih plinov je lahko direktno speljan v dimnik samo v primeru, da je le-ta maksimalnih dimenzij 20 x 20 cm ali premera 20 cm in je opremljen z odprtino za pregled;
- v primeru, da je dimnik večjih dimenzij, je potrebno vanj vstaviti nerjavno cev (s potrebnim premerom), ki je pravilno izolirana;
- prepričajte se, da je povezava z dimnikom pravilno zatesnjena;
- izogibajte se kontaktu z gorljivim materialom (kot npr. lesni ogorki), v vsakem primeru pa jih izolirajte z ognjeodpornim materialom.

Ko uporabljate priključke med kotlom na pelete in dimnikom, je obvezno uporabljati kolena s čistilnimi vratci (**Slika 3**). Uporaba kolen s čistilnimi vratci omogoča redno čiščenje, ne da bi bilo pri tem potrebno cevi razstavljati. Izpušni plini v dimniškem priključku so pod rahlim pritiskom, zato je potrebno obvezno preveriti, da je pokrov za čiščenje pepela popolnoma hermetično zaprt in da tako tudi ostane po vsakem čiščenju. Prepričajte se, da je vse skupaj ponovno pravilno sestavljeno in preverite stanje tesnila.



**Slika 3: Čistilni kos**

Povezava med cevmi naj bo vedno z moškim priključkom, obrnjenim navzgor (**Slika 4**).

Priporočljivo je, da se izogibate daljšim vodoravnim povezavam cevi na dimnik. V kolikor to ni možno, naj ne bodo cevi postavljene pod kotom navzdol, temveč pod kotom navzgor za vsaj 5% (**Slika 5**). Vodoravna postavitev cevi naj ne presega 2 m dolžine.

Ni priporočljivo speljati cevi s kotla na pelete neposredno na dimnik z vodoravno cevjo, daljšo od 1 m.

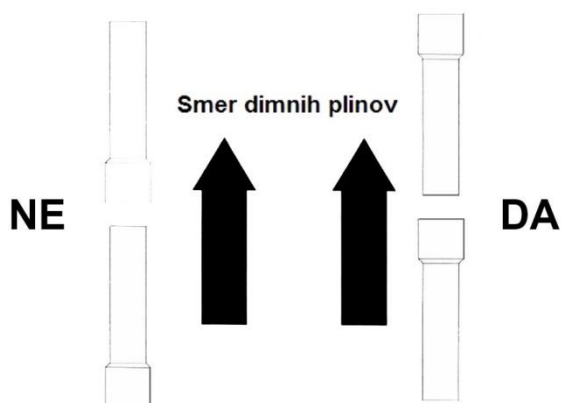

**Slika 4**



**Slika 5**

### 4.3 IZOLACIJA IN PREMER LUKENJ NA STREHI

Ko je znan položaj za vgradnjo kotla, je potrebno narediti luknjo za prehod dimnih cevi. Ta se spreminja glede na vrsto vgradnje, premer dimnih cevi in tip zidu ali strehe, skozi katero mora biti speljana. Izolacija mora biti mineralnega izvora (kamena volna), z nominalno gostoto večjo od 80 kg/m<sup>3</sup>.

Popolni vlek je odvisen predvsem od dimnika, ki mora biti brez preprek, kot so npr. ozka grla in/ali razni kotni priključki. Kolena naj bodo pod kotom 30°, 45° in 90°. Kolena pod kotom 90° naj bodo tridelna (**Slika 6**).

V vsakem primeru je obvezno zagotoviti začetno navpično ravno cev dolžine 1.5 metra (minimalno), le tako lahko zagotovimo pravilen odvod dimnih plinov.

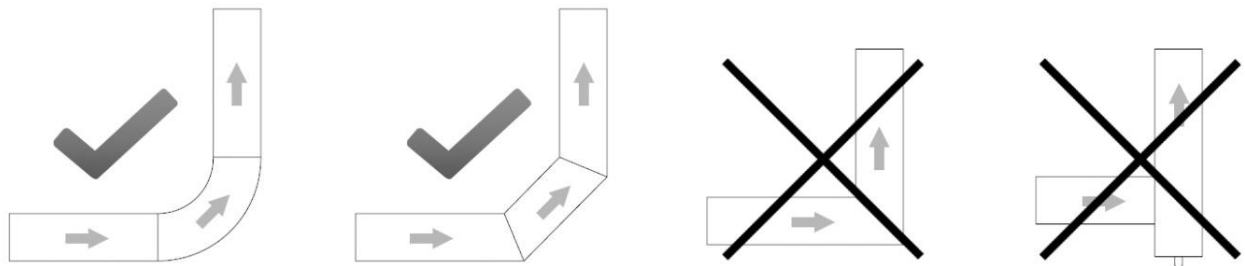

Slika 6

### 4.4 DOVODNI ZRAK

Zrak iz prostora, potreben za pravilno izgorevanje, mora biti obnovljen z novim zrakom, bodisi preko odprtine na steni, reže na vratih kotlovnice ali mreže na oknu. To vam bo zagotovilo pravilno izgorevanje in pravilno delovanje kotla.

Odprtina za dovod svežega zraka mora biti opremljena z zaščitno režo proti dežju, vetru ter insektom.

Luknja mora biti narejena na zunanjo steno prostora, kjer se nahaja kotel na pelete.

Standard UNI 10683 prepoveduje odjem dovodnega zraka iz skladišča gorljivih materialov ali prostorov, kjer obstaja možnost nastanka ognja.

V primeru, ko se v prostoru nahajajo še druge kurilne naprave, je potrebno zagotoviti zadostno količino zraka, potrebnega za pravilno izgorevanje vseh kurilnih naprav in upoštevati vse tehnične lastnosti že vgrajenih prezračevalnih sistemov v kurilnici.

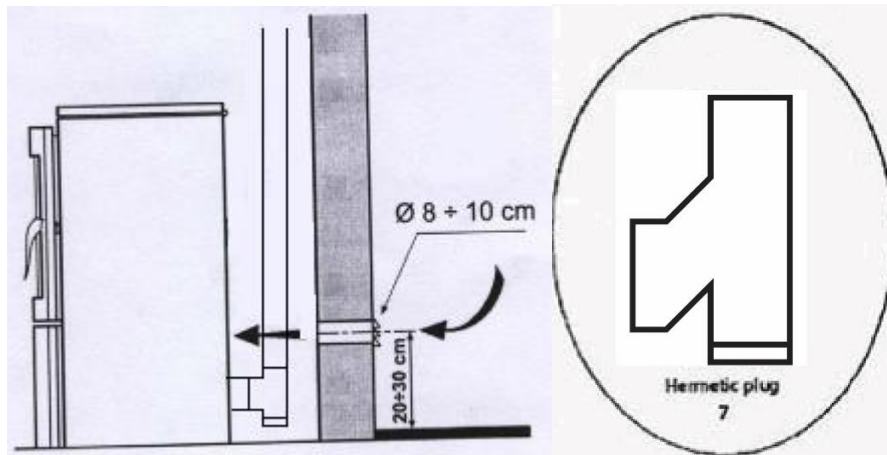

**Slika 7**

## 4.5 ELEKTRIČNA VEZAVA

Kurilna naprava zahteva povezavo na električno omrežje. Naši kotli na pelete so opremljeni z napajalnim kablom za srednje temperature. Če je električni napajalni kabel poškodovan in ga je potrebno zamenjati, pokličite našo servisno službo.

Preden pričnete z električno vezavo se prepričajte, da:

- so karakteristike električne napeljave v skladu s podatki na kurilni napravi;
- **so odvod dimnih plinov ozemljeni v skladu z veljavnimi predpisi in lokalnimi zahtevami. (Ozemljitev je zakonsko določena);**
- **električni napajalni kabel ne sme v nobenem primeru doseči temperature, ki je 80°C nad temperaturo ambienta.** Če želite kotel vezati neposredno na električno omrežje, je potrebno vstaviti bipolarno stikalo z minimalno razdaljo 3 mm med kontakti, primerno za zahtevano električno napetost in v skladu z veljavnimi predpisi. Rumeno/zeleni kabel za ozemljitev mora biti prekinjen s stikalom. Bipolarno stikalo mora biti vedno dosegljivo, tudi po tem, ko je kotel že vgrajen.

### **Električna vezava**

Kotel na pelete mora biti priklopljen na električno omrežje. Električni napajalni kabel kotla je dolg 3 m, bele barve in označen z napisom »220 V«. Drugi priključni kabel je namenjen priklopu črpalke, je črne barve in označen z napisom »Črpalka«. Naše peči na pelete so opremljene z napajalnim kablom za srednje temperature. Če je električni napajalni kabel poškodovan in ga je potrebno zamenjati, pokličite našo servisno službo. V primeru okvare ali nepravilnega delovanja peči, peč takoj izklopite, premaknite stikalo v položaj OFF (0) in kontaktirajte pooblaščen servisni center.

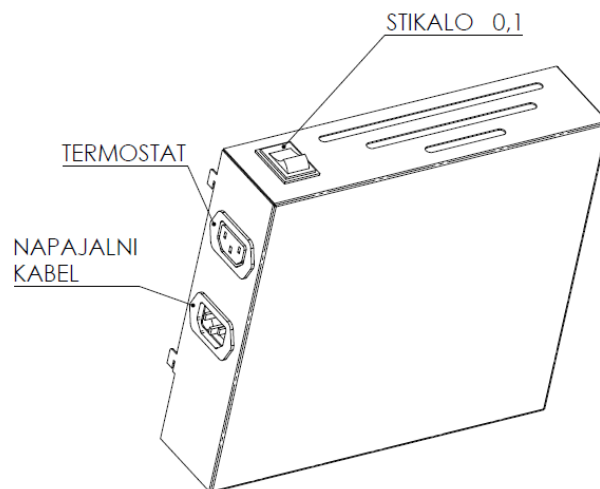

**Slika 8**

Preden pričnete z električno vezavo se prepričajte, da:

- so karakteristike električne napeljave v skladu s podatki a kurilni napravi;
- so odvodi dimnih plinov ozemljeni v skladu z veljavnimi predpisi in lokalnimi zahtevami. **Ozemljitev je zakonsko predpisana;**
- električni napajalni kabel ne sme v nobenem primeru doseči temperature, ki je 80°C nad temperaturo ambienta. Če želite peč vezati neposredno na električno omrežje, je potrebno vstaviti bipolarno stikalo, ki mora biti vedno dosegljivo, tudi po tem, ko je peč že vgrajena;
- če peči dalj časa ne boste uporabljali, izvlecite napajalni kabel ali peč izključite (premaknite stikalo v položaj OFF (0)).

## 5 PRVI ZAGON KOTLA

---

**Prvi zagon kotla lahko izvede samo s strani proizvajalca pooblaščen serviser, v nasprotnem primeru garancija ni veljavna.**

### NAVODILA ZA VARNOST OSEB, ŽIVALI IN OSEBNE LASTNINE

Inštalaterja želimo obvestiti o nekaterih splošnih smernicah, ki se jih je potrebno držati, da bo kotel na pelete pravilno vgrajen. To so zahtevani standardi, vendar pa niso dovolj; za več in bolj natančne informacije je potrebno, da si preberete preostali del *Navodil za uporabo, vzdrževanje in vgradnjo*.

- Povežite kotel na pelete v električno omrežje.
- Ne dovolite, da se kotlu na pelete približajo otroci in živali.
- Uporabljajte samo dobro kvaliteto pelet in ne drugih vrst goriv.
- Obvestite vse uporabnike o morebitnih tveganjih in nevarnostih, ter jih podučite o ravnanju s kotlom na pelete.
- Če je kotel na pelete postavljen na lesena tla, je potrebno tla zaščititi skladno z predpisi.

# 6 VARNOSTNA OPOZORILA

---

## 6.1 VARNOSTNA OPOZORILA ZA SERVISERJE

Poleg splošnih varnostnih predpisov mora vzdrževalec:

- vedno uporabiti varnostne naprave in individualne varnostne pripomočke po direktivi 89/391/EEC;
- izklopiti električno napajanje preden prične s kakršnim koli delom;
- vedno uporabljati primerna orodja;
- preden začne s kakršnim koli delom na kotlu, se mora prepričati, da sta tako kotel kot tudi pepel v njem hladna, še posebej preden se ga dotakne;
- **KOTLA NA PELETE NE SMATRAJTE ZA UPORABNEGA, ČE JE LE ENA SAMA OD VARNOSTNIH NAPRAV V OKVARI, NEPRAVILNO POPRAVLJENA ALI NEDELUJOČA;**
- ne delajte kakršnih koli sprememb, kakršnega koli tipa, za kakršen koli razlog razen tistih, ki so dovoljeni in/ali odobreni s strani proizvajalca ali pooblaščenih oseb;
- vedno uporabljajte originalne rezervne dele. Ne čakajte, da del kotla dotraja, preden ga zamenjate. Zamenjava obrabljenega dela kotla, preden le-ta odpove, pomaga preprečiti poškodbe, povzročene zaradi nenadne odpovedi komponente, ki lahko resno ogrozi varnost oseb in/ali njihovega premoženja;
- pri čiščenju pepela očistite tudi izgorevalno posodo in prostor pod njo.

## 6.2 VARNOSTNA OPOZORILA ZA UPORABNIKA

Prostor, v katerem se bo kotel na pelete nahajal, ali vgradni prostor, mora biti v skladu z lokalnimi, nacionalnimi in evropskimi direktivami.

Kotel na pelete je kurilna naprava, določene zunanje površine kotla imajo lahko med delovanjem višje temperature.

Kotel na pelete je izdelan izključno za kurjenje lesnih pelet (peleti premera 6 mm in dolžine do 30 mm z najvišjo vsebnostjo vlage do 10%) oz. za gorivo A1 (lesni peleti) skladno s standardom EN 14961-2.

Pri uporabi kurilne naprave je priporočljivo skrbno upoštevati:

- med delovanjem kotla NE hodite blizu in se ne dotikajte vrat izgorevalne komore, ker obstaja NEVARNOST OPEKLIN;
- med delovanjem kotla NE hodite blizu in se NE DOTIKAJTE DIMNIŠKEGA PRIKLJUČKA, ker obstaja NEVARNOST OPEKLIN;
- med delovanjem kotla NE izvajajte kakršnega koli čiščenja na kurilni napravi;
- med delovanjem kotla ne odpirajte vrat kurišča, ker le-ta deluje pravilno samo pod pogojem, da so vrata kurišča hermetično zaprta (v primeru odpiranja med delovanjem se bo pojavil Alarm);
- med delovanjem kotla NE odstranjujte pepela;
- otrokom in živalim NE dovolite pristopa h kotlu na pelete;
- UPOŠTEVAJTE ZAHTEVE IZ TEGA DOKUMENTA!

Za pravilno uporabo kotla upoštevajte tudi naslednje napotke:

- uporabljajte samo in izključno gorivo, ki ga predpisuje proizvajalec kotla;
- upoštevajte navodila za vzdrževanje;
- očistite kurišče kotla na vsak porabljen zalogovnik peletov (3-14 dni, ko sta kotel na pelete in pepel v njem hladna);
- NE uporabljajte kotla na pelete v primeru nepravilnega delovanja ali drugih nepravilnosti, čudnih zvokov in/ali sumljivih okvar in TAKOJ pokličite pooblaščen servisno službo;
- NE polivajte vode po kotlu, kakor tudi ne gasite ognja v izgorevalni komori z vodo;
- NE naslanjajte se na kotel, ker je morda nestabilen in se lahko prevrne;
- NE uporabljajte kotla na pelete kot podporo ali kot predmet za pričvrščevanje. Ne puščajte odprtega pokrova zalogovnika;
- NE dotikajte se barvanih delov kotla med njegovim delovanjem;
- NE uporabljate lesa ali oglja v kotlu za pelete, temveč samo pelete z naslednjimi karakteristikami:
  - dimenzija: premer 6 mm,
  - maksimalna dolžina: 30 mm,
  - vsebnost vlage: do 10%,
  - kurilna vrednost: minimalno 16,9 MJ/kg oz. 4,7 kWh/kg,
  - vsebnost pepela: pod 0,7%;
- NE uporabljajte kotla kot sežigalnik;
- vedno poskrbite za popolno varnost.

## 7 NAVODILA ZA VAREN VŽIG KOTLA TER VARNO ČIŠČENJE

---

Nikoli NE uporabite kurilnega olja, olja za svetilke ali katerega koli drugega olja oziroma katere koli druge vnetljive tekočine za prižiganje kotla na pelete. Hranite vse take in podobne vrste tekočin daleč stran od kotla na pelete, medtem ko le-ta deluje.

Prepričajte se, da je kotel na pelete pravilno postavljen, ter da se ne premika.

Prepričajte se, da ste kurišče pravilno zaprli, ter da je zaprto medtem ko kotel na pelete deluje.

Pepel sesajte le takrat, ko je kotel na pelete hladen.

Ne uporabljajte abrazivnih sredstev za čiščenje kotla na pelete.

### 7.1 REDNO VZDRŽEVANJE IN ČIŠČENJE KOTLA

Uporaba sesalnika s separatorjem vam bo olajšala delo pri čiščenju pepela iz kotla.

Preden začnete s kakršnim koli vzdrževanjem, tudi s čiščenjem, upoštevajte sledeče varnostne ukrepe:

- izklopite kotel na pelete preden pričnete s kakršnim koli delom;
- preden pričnete s kakršnim koli delom na kotlu se prepričajte, da je pepel v kotlu hladen.



Posesajte pepel iz izgorovalne komore vsaj enkrat na deset dni oz. ob vsakem porabljenem zalogovniku peletov (samo ko je kotel hladen) (**Slika 10**).

Posesajte ter pazljivo očistite kurilno posodo vsaj enkrat na deset dni oz. ob vsakem porabljenem zalogovniku peletov (samo ko je kotel hladen) (**Slika 10**).

Enkrat mesečno odstranite prednja vrata na dnu izmenjevalca na desni strani kotla in posesajte znotraj (**Slika 10**).

Vedno se prepričajte, da sta kotel na pelete in pepel v njem hladna.

To je kurilna posoda, kjer gorijo peleti (**Slika 9**). Priporočamo vam, da ob vsakem čiščenju pregledate in očistite pepel z dna izgorovalne komore. Ko postavite kurilno posodo nazaj na svoje mesto se prepričajte da je pravilno postavljena: potisnjena mora biti proti zadnji steni do konca. Le tako ste lahko prepričani, da bo kotel pravilno deloval.

2. Odprtina za vstavljanje  
grelnega elementa za  
sežiganje goriva.

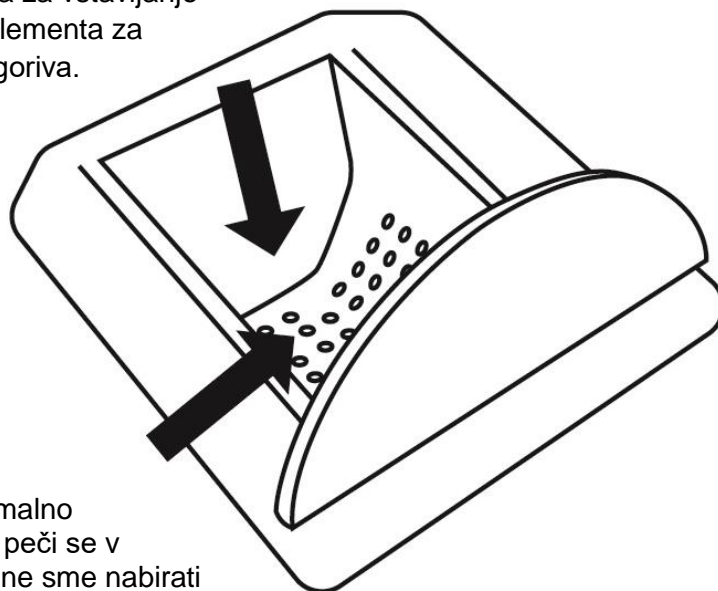

1. Za optimalno  
delovanje peči se v  
odprtinah ne sme nabirati  
pepel.

**Slika: 9**

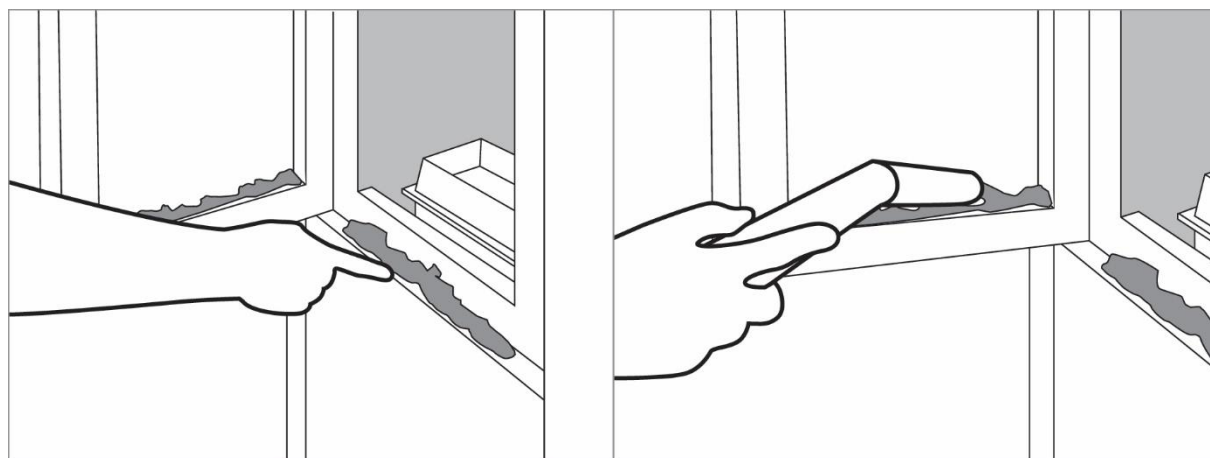

**Slika: 10**

Za kakršno koli potrebno pojasnilo ne odlašajte ter pokličite svojega inštalaterja. Ker proizvajalec nima nadzora nad opravljenim delom inštalaterja, ne more zagotavljati izvedbe njegovih del ter vzdrževanja.

**Proizvajalec v nobenem primeru ni odgovoren za škodo, nastalo zaradi tretje osebe.**

Izgorevalna komora mora biti očiščena na vsak porabljen zalogovnik peletov, posesana in/ali izpraznjena vseh nečistoč, ki so ostale v njej po tem, ko so peleti zgoreli.

Nikoli ne dajajte pelet, ki niso zgoreli, nazaj v zalogovnik za pelete ali v posodo za pepel.

## **7.2 KONTROLA IN DELI, POTREBNI VZDRŽEVANJA**

PREVERITE NASLEDNJE TOČKE IN SE NA TA NAČIN PREPRIČAJTE, DA KOTEL NA PELETE DELUJE PRAVILNO. S TEM BO NJEGOV IZKORISTEK VEČJI IN TUDI ODDANA TOPLOTA V SISTEM BO VEČJA:

- Za popolno čiščenje je potrebno vsak teden, ali na vsakih porabljenih 45 kg pelet (kar nastopi prej,) posesati pepel izpod kurilne posode ter iz izgorevalne komore. Za čiščenje sten kurišča lahko uporabite metlico ali čopič.
- Čiščenje ventilatorja za odvod dimnih plinov se izvede tako, da odstranite zaščito ventilatorja in očistite krilca ventilatorja z metlico ali s čopičem.

SPLOŠNO POSEZONSKO ali PREDSEZONSKO ČIŠČENJE KOTLA:

- Po končani kurilni sezoni izklopite kotel iz električnega omrežja. Zelo pomembno je, da očistite in pregledate kotel na način, ki je opisan v navodilih.
- Tesnilo na vratih, ki je pritrjeno z visokotemperaturno odpornim pričvrščevalcem, lahko po daljšem časovnem obdobju odstopi. Da bi ga ponovno pričvrstili, je potrebno na zadnjo stran tesnila nanesti visokotemperaturni pričvrščevalec. S tem zagotovite hermetično tesnjenje vrat kurišča.

DIMNIŠKI PRIKLJUČEK - DIMNIK (na koncu vsake kurilne sezone ga je potrebno očistiti):

- Dimniški kanal, dimnik in dimniško kapo je potrebno pregledati in očistiti vsako leto. Za profesionalno opravljeno delo kontaktirajte vašega dimnikarja.

## **7.3 DODATNO VZDRŽEVANJE**

Vaš kotel na pelete je generator toplote, v katerem se uporabljajo peleti. Enkrat letno zahteva posebno vrsto vzdrževanja s strani pooblaščenega osebja podjetja Gorenje d.d..

Z rednim letnim servisom boste ohranjali dobro delovanje kurilne naprave, zagotavljali njeno večjo učinkovitost, obdržali veljavnost garancije in podaljšali življenjsko dobo same naprave.

Vrsto del, ki so opisana v prejšnjem poglavju, je priporočljivo opraviti po končani kurilni sezoni. Njihov namen je preveriti in zagotoviti brezhibno delovanje vseh komponent.

## 8 POMEMBNI VARNOSTNI PODATKI

---

Kupili ste izdelek najvišje kakovosti.

Dobavitelj vam je na razpolago pri posredovanju podatkov, ki jih potrebujete. Pravilna vgradnja kurilne naprave v skladu z navodili je pomembna zato, da preprečite kakršno koli slabo delovanje, tveganje ali možnost požara.

Kotel na pelete deluje na osnovi podtlaka v izgorevalni komori, zato se vedno prepričajte, da dimniški priključek termično tesni.

## 9 KVALITETA PELET JE ZELO POMEMBNA

---

Kotel na pelete je narejen za uporabo pelet. Ker se na trgu pojavljajo razne vrste in dimenzije pelet, je zelo pomembno, da si zagotovite pelete, ki ne vsebujejo nečistoč. Prepričajte se, da uporabljate le pelete, ki so kompaktni in brez prahu. Vprašajte vašega dobavitelja po primernih peletih, katerih premer mora biti 6 mm ter dolžina do 30 mm. Pravilno delovanje kotla na pelete je odvisno od vrste in kvalitete pelet.

Pelete polnimo v zalogovnik z zgornje strani skozi odprtino na pregibnem pokrovu zalogovnika (**Slika 11**). Pozorni bodite, da med polnjenjem v zalogovnik ne zaidejo trdi predmeti, folija ali drugi predmeti, ki bi lahko ovirali delovanje dozirnega polža.

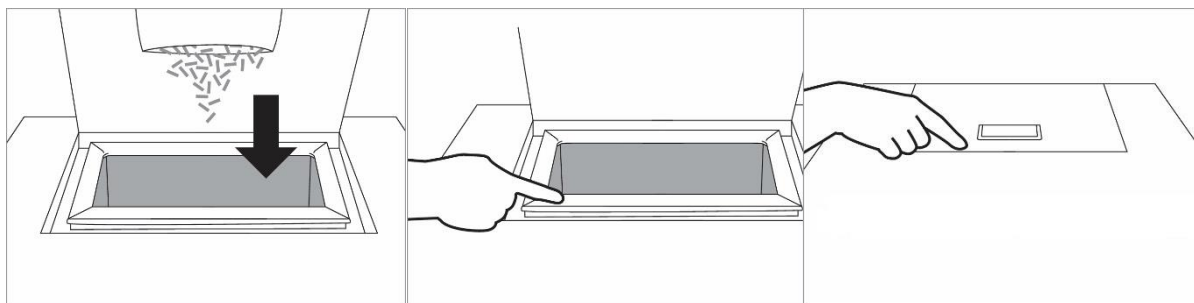

**Slika 11**

### 9.1 SKLADIŠČENJE PELET

Peleti naj se hranijo na suhem in ne preveč hladnem prostoru.

Hladni in/ali vlažni peleti (temperature okrog 5°C) zmanjšajo termično moč in zahtevajo pogostejše čiščenje kotla.

Pri rokovanju s peleti bodite previdni, da jih ne raztresete.

Če nasujete v zalogovnik žagovino, lahko le-ta blokira dozirni sistem pelet.

# 10 OPIS IN DELOVANJE KRMILNE NAPRAVE

## 10.1 OPIS TIPKOVNICE S PRIKAZOVALNIKOM

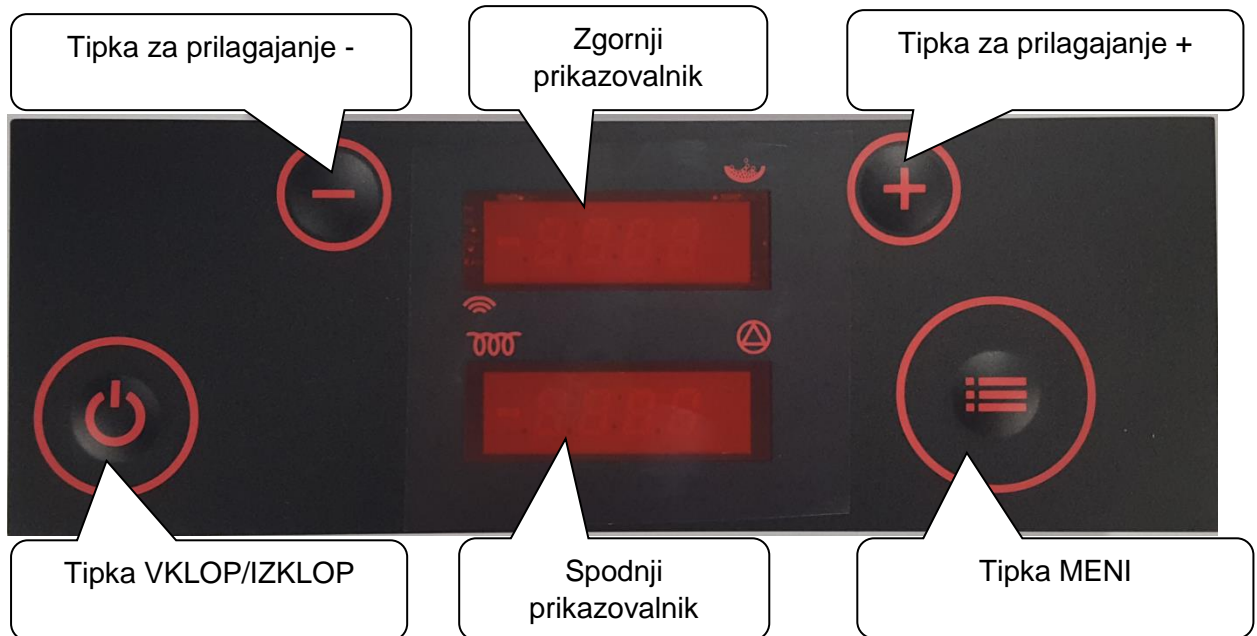

### Prikazovalniki

### Funkcija



**zgornji prikazovalnik** prikazuje status kotla, izbrani meni ter podaja indikacijo delovanja doziranja in delovanje v časovnem programu



**spodnji prikazovalnik** prikazuje trenutni čas, vrednost nastavitev in parametrov ter imena opozoril



indikator delovanja vžigalne svečke



indikator delovanja črpalke



indikator delovanja doziranja

## Prikazovanje med delovanjem kotla v fazi gorenja

Zgornji prikazovalnik: zgornji prikazovalnik izmenično prikazuje:  
**BURN** ter nato **P5D5**, pri čemer **Px** pomeni dejansko trenutno moč delovanja in **DX** nastavljeno moč delovanja

---

Spodnji prikazovalnik: Spodnji prikazovalnik izmenično prikazuje:  
Temperaturo dimnih plinov: **155**  
Temperaturo vode v kotlu : **B72**  
Temperaturo povratne vode: **r45**

---

## Prikazovanje med mirovanjem kotla:

Zgornji prikazovalnik: **OFF**

---

Spodnji prikazovalnik: Ura: **18:35**

---

Tipka	Funkcija
	<b>Tipka VKLOP/IZKLOP</b> Daljši pritisk vključi/izključi kotel. Kratek pritisk povrne osnovni prikaz.
	<b>Tipka GOR</b> Pritisk med delovanjem poveča nastavljeno moč. Ob predhodnem kliku na tipko MENI, s to tipko povečujemo željeno temperature vode v kotlu. V menijskem način s pritiskanjem izbiramo želeni podmeni.
	<b>Tipka DOL</b> Pritisk med delovanjem zmanjša nastavljeno moč. Ob predhodnem kliku tipke MENU, s to tipko zmanjšujemo željeno temperature vode v kotlu. V menijskem način s pritiskanjem izbiramo želeni podmeni.



### Tipka MENI

S kratkim pritiskom v osnovnem prikazu se prikaže nastavljena vrednost temperature vode v kotlu in jo nato lahko spreminjamo s tipkama + in -.

S pritiskom, daljšim od 2 sekund, aktiviramo menijski način.

S pritiskom, daljšim od 4 sekund, vstopimo v napredne menijske nastavitve. Z držanjem pritisnjene tipke izbiramo posamezne podmenuje.

Za izbor parametra v podmenijih uporabljamo tipke GOR in DOL. S kratkim pritiskom na tipko MENI prične utripati nastavljena vrednost parametra, ki jo lahko spremenimo s tipkama GOR in DOL.

S kratkim pritiskom na tipko VKLOP/IZKLOP ali držanjem tipke MENI do preleta vseh menijskih izbir, se vrnemo v osnovni prikaz.

## 10.2 KOTEL MED DELOVANJEM

Prikazovalnik prikazuje trenutno delovno fazo (npr. TestFire, HeatUp itn.). Zgornji prikazovalnik prikaže nastavljeno in dejansko moč kotla izmenično vsakih 5 sekund.

S pritiskom na **tipko GOR** se nastavljena vrednost moči poveča, s pritiskom na **tipko DOL** pa zmanjša.

S pritiskom na **tipko MENI** se prikaže nastavljena temperatura vode v kotlu. S **tipkama GOR in DOL** se jo lahko spremeni. Za hiter dostop do spreminjanja željene temperature kotla je potrebno pritisniti tipki gor ali dol.

Kotel deluje na nastavljeni moči dokler temperatura vode v kotlu ne doseže praga modulacije ali dokler dimni plini ne dosežejo limite. V prvem primeru se prikaže Regu H2O, v drugem pa Regu Gas.

V primeru izpada omrežne napetosti v trajanju manj kot 2 minuti, bo kotel nadaljeval z normalnim obratovanjem, ko se omrežna napetost povrne. Če je izpad daljši od 2 minut, bo kotel samodejno opravil varnostno zaustavitev in ohladitev ter nato ponoven zagon.

### 10.3 ZAUSTAVITEV KOTLA

Ob pritisku na **tipko VKLOP/IZKLOP**, daljšem od pol sekunde (kotel med delovanjem), prikazovalnik prikaže **ON**, kotel pa prične sekvenco zaustavitve, ko tipko spustimo. Izklopi se dozirni polž, prikazovalnik pa prikaže napis **STOP FIRE**. Ventilatorji delujejo z omejeno hitrostjo, da preprečijo prevelik dvig temperature vode v kotlu. Ko se kotel ohladi pod določeno temperaturo, pa ventilatorji preklopijo na maksimalno hitrost in izpihajo še zadnje delce iz kurišča. Prikaže se napis **OFF**.

### 10.4 VKLOP KOTLA

Ob pritisku na **tipko VKLOP/IZKLOP**, daljšem od pol sekunde (kotel v mirovanju), prikazovalnik prikaže **OFF**, kotel pa prične vklopno sekvenco, ko tipko spustimo. Prikaže se napis **TESTFIRE**. Ventilatorji delujejo z visoko hitrostjo, da očistijo kurišče. Dozirni polž miruje, vžigalna svečka greje.

V primeru, da je temperatura kurišča nizka, se nato zažene sekvenca **HEAT UP**, v kateri se hitro dozirajo peleti in ventilatorji mirujejo. Nato se zaženejo sekvence **Fuel IGNI** in **TEST IGNI**, dokler kotel ne doseže pogojev za prehod v fazo gorenja (**BURN**).

S pritiskom na **tipko MENI** v trajanju 2 sekund (tipko spustimo, ko se prikaže tH2O) se prikaže trenutna temperatura vode v kotlu. S pritiskom na **tipko GOR** oziroma **tipko DOL** izberemo prikaz še ostalih temperatur in statusa ventilatorjev.

## 10.5 NASTAVITEV ČASOVNEGA PROGRAMA

Z daljšim pritiskom na **tipko MENI** (dokler se ne prikaže napis **TEN**) pridete v meni časovnega programa. Po meniju se pomikate s tipkama **GOR/DOL**. S pritiskom na tipko **MENI** izberete funkcijo, s tipkama **GOR/DOL** nastavite vrednost in jo s tipko **MENI** potrdite. Z nastavitvijo **ON** oziroma **OFF** je časovni program aktiven oziroma neaktiven. Potrebno je nastaviti točen čas in trenutni dan v tednu (1 je ponedeljek ipd.) ter nato sprogramirati 6 programskih period in temperatur.

Vsaka od 6 časovnih period je določena z začetnim (**P1a** – program 1 čas vklopa) in končnim časom (**P1d** – program 1 čas izklopa). Znotraj tega obdobja je kotel aktiven in deluje tako, da vzdržuje nastavljeno temperaturo vode v kotlu (**P1t**).

Nato za vsak dan v tednu izberemo do 3 časovne periode.

Primer (torek): zgornji prikazovalnik prikazuje **DAY2**, spodnji pa **P1**, **P3** in **P6** kar pomeni, da bo v torek kotel aktiven v periodah sprogramiranih s programi **P1**, **P3** in **P6**. Periode nastavite tako, da pritisnete tipko **MENI** na določenem dnevu (primer: zgornji prikazovalnik **DAY2** – **torek**), kjer je na spodnjem prikazovalniku **t1P1** in začne **P1** utripati. S pritiskom na tipki **GOR/DOL** izberete številko periode, ki ste jo predhodno nastavili. S pritiskom na tipko **MENI**, potrdite izbrano periodo za **t1** in izberete za **t2** in **t3**. Ko izberete periodo za **t3**, potrdite z tipko **MENI** (**Px** pri **t3** preneha utripati in se na spodnjem prikazovalniku prikaže **t1**) in s tem ste nastavili 3 periode za **DAY2**. Enak postopek je potem za katerikoli dan v tednu.

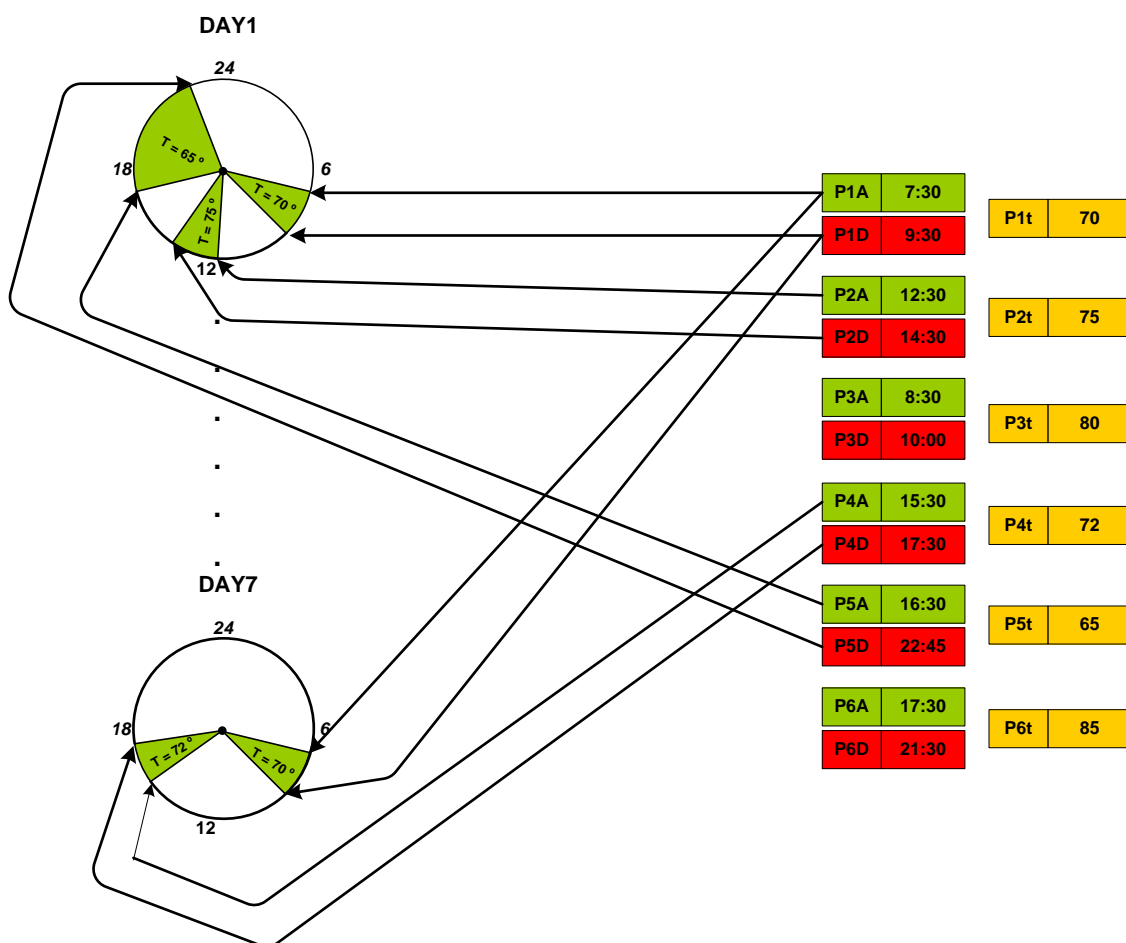

Slika 12: Diagram timerskih nastavitev



## 10.6 NAPISI IN SPOROČILA NA PRIKAZOVALNIKU

### Napisi na Prikazovalnikih

### Pomen sporočila in status kotla

OFF	Kotel je v mirovanju.
12:53	
°OFF	Kotel je v mirovanju, vendar je aktiven časovni program in se bo samodejno zagnal, kot nastavljeno s časovnim programom.
12:53	
TEST	Kotel preverja, če je v kurišču plamen in ustrezno izgorevanje. Ta sekvenca se sproži po izpadu omrežne napetosti.
FIRE	
HEAT	V fazi vžiga, ko je dozirni polž napolnil kurišče, vžigalna svečka segreva pelete do vžiga.
UP	
FUEL	Po fazi Heat up kotel vžiga pelete. V tej fazi ni doziranja.
IGNI	
TST	Na koncu vžigne faze kotel izključi vžigalno svečko ter testira ali je vžig uspel in ali je izgorevanje pravilno ter temperature pravilno naraščajo.
IGNI	
BURN	Faza gorenja (ki je običajna delovna faza). Spodnji prikazovalnik prikazuje temperaturo dimnih plinov na izhodu iz kotla.
123	
BURN	Faza gorenja. Spodnji prikazovalnik prikazuje temperaturo vode v kotlu.
B78°	
BURN	Faza gorenja. Spodnji prikazovalnik prikazuje temperaturo povratne vode.
R48°	
P5D5	Faza gorenja. Zgornji prikazovalnik prikazuje trenutno moč kotla (Px) in nastavljeno moč kotla (Dx).
R48	
CLN	Faza čiščenja. Ventilatorji izpihujejo pepel in druge ostanke iz kurišča. Ta faza se občasno samodejno zažene med fazo gorenje.
FIRE	

FIRE	Kotel je v sekvenci ustavljanja in se ohlaja.
STOP	
COOL	Ko tudi pri minimalni moči temperatura vode v kotlu doseže določeno temperaturo, gre kotel v fazo COOL FLUID in se ohladi. Kotel se bo samodejno zagnal, ko se voda v kotlu ohladi pod določeno vrednost.
FLUID	
ALAR	V fazi gorenja je zmanjkalo peletov.
PELL	
ALAR	Neuspešen vžig. Preverite stanje kotla, očistite kurišče in poskusite ponovno vžgati kotel.
FIRE	
ALAR	Termično varovalo je aktivirano. Preverite stanje kotla in, v kolikor ne opazite nobene anomalije, ročno reaktivirajte varovalo in ponovno zaženite kotel, sicer pokličite servisno službo.
STB	
ALAR	Varnostni presostat je aktiviran. Preverite stanje kotla in, v kolikor ne opazite nobene anomalije, ponovno zaženite kotel, sicer pokličite servisno službo.
PRES	
ALAR	Ni signala tipala dimnih plinov. Pokličite servisno službo.
TC1	
ALAR	Ni signala temperature kurišča. Pokličite servisno službo.
TCH	
ALAR	Potrebno očistiti kotel in/ali dimnik.
DRTY	
ALAR	Ni signala temperature vode. Pokličite servisno službo.
NTC	
ALAR	Temperatura dimnih plinov je previsoka.
GASS	

# 11 MENIJI

Ob zadržanju tipke MENI se vrstijo meniji. Za izbor posameznega menija je potrebno ob prikazu zelenega menija tipko izpustiti. Opisi posameznih menijev so opisani spodaj:

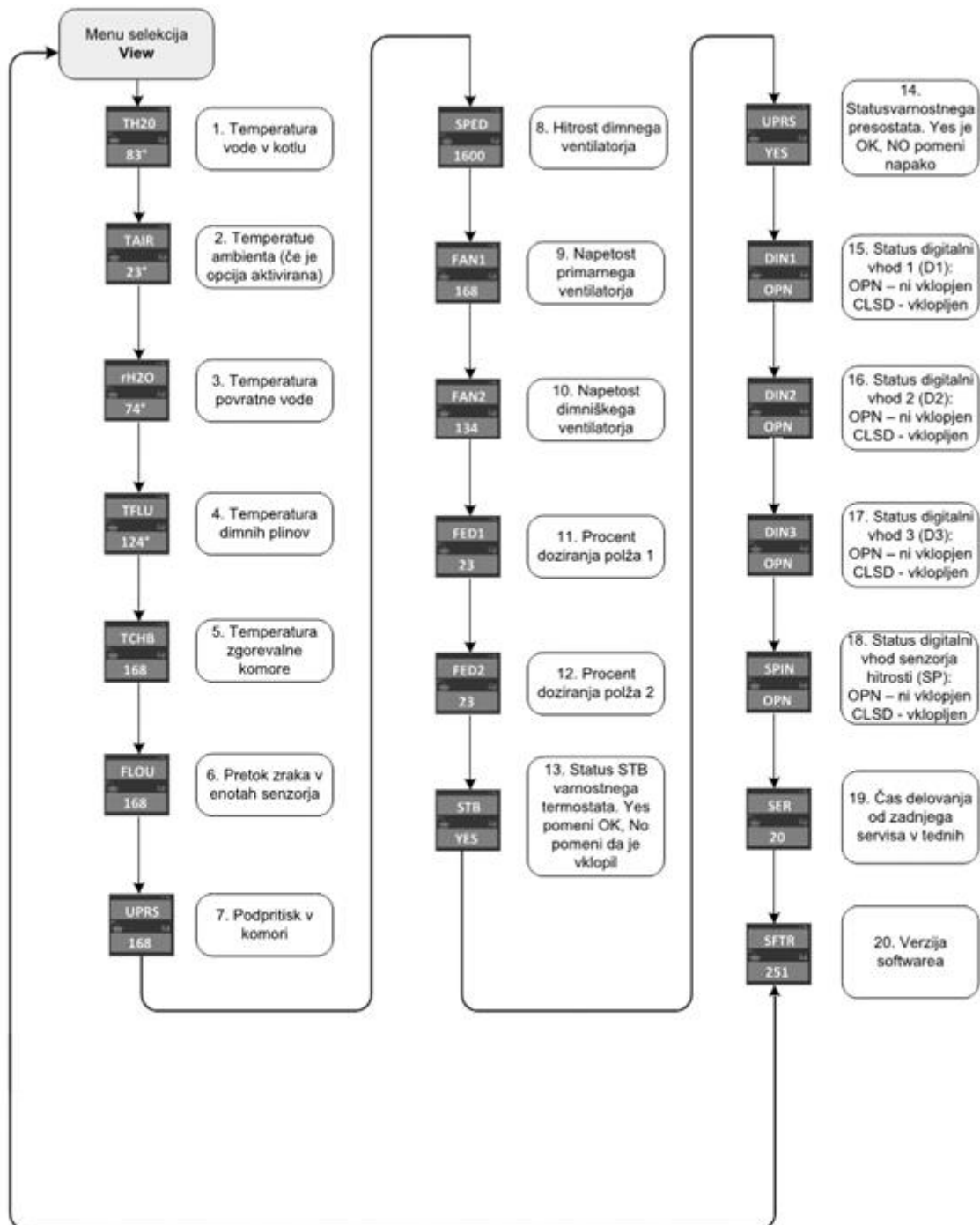

Slika 13: Opis menijev

## 12 ALARMNA STANJA

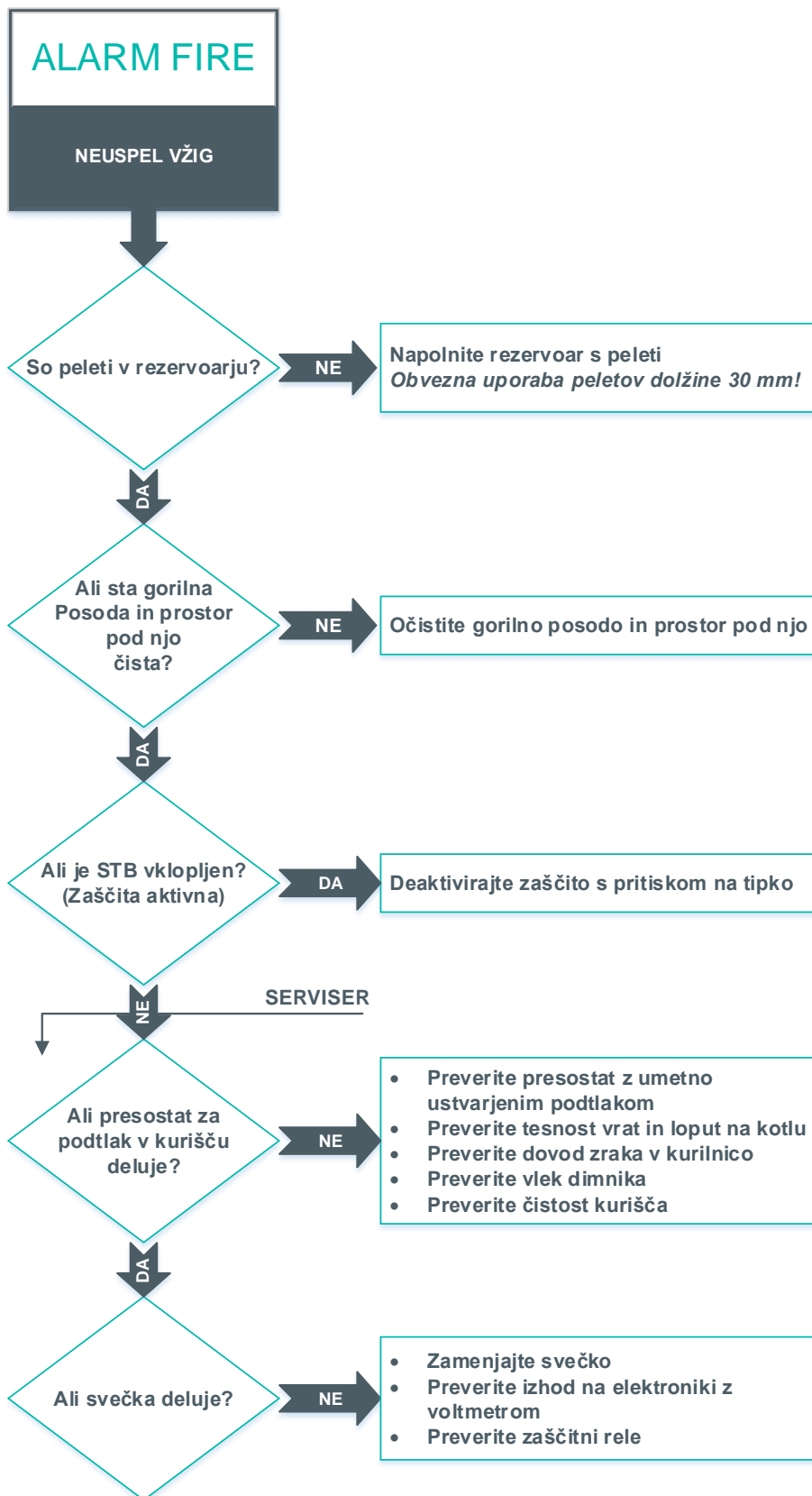

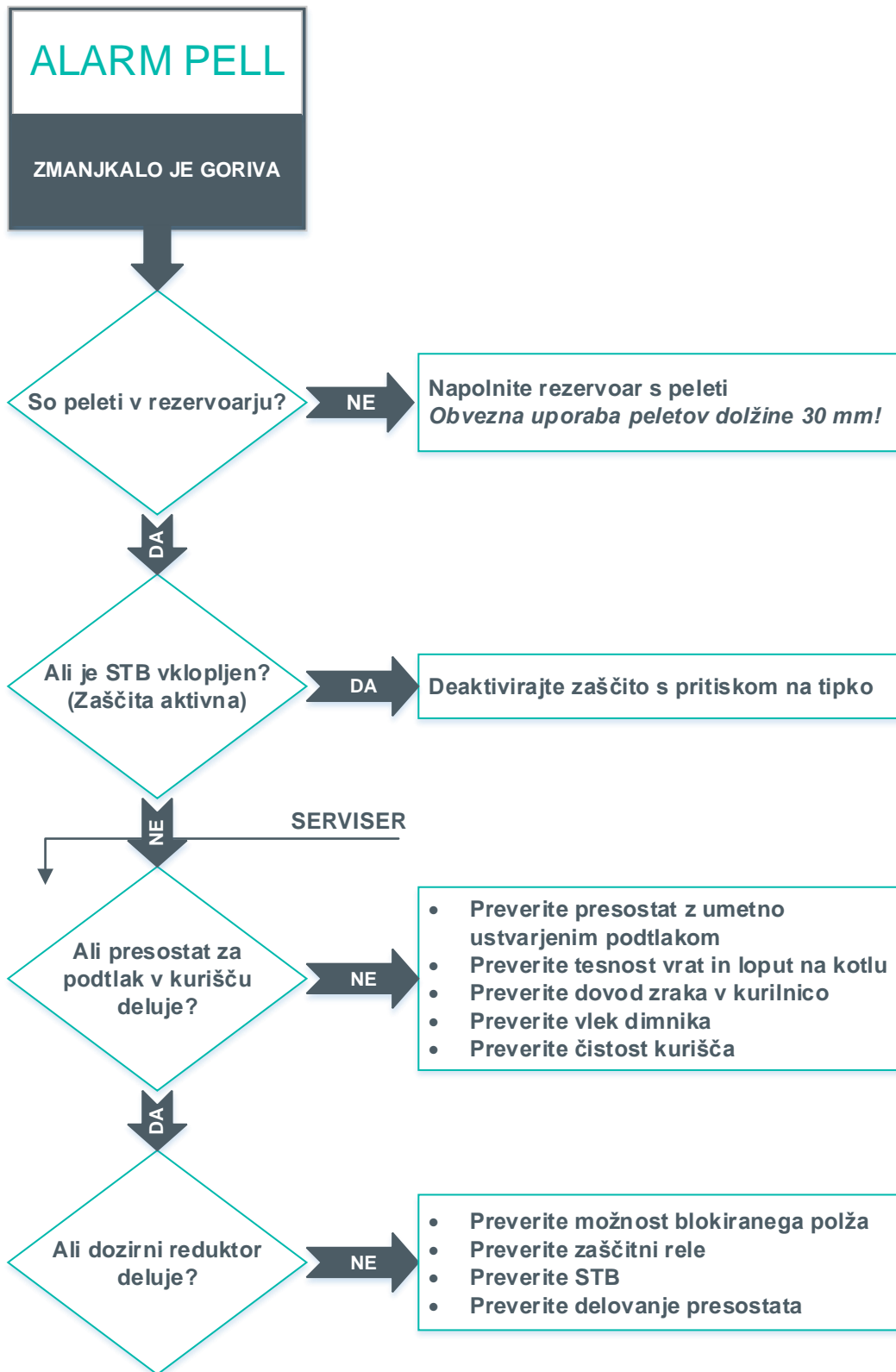

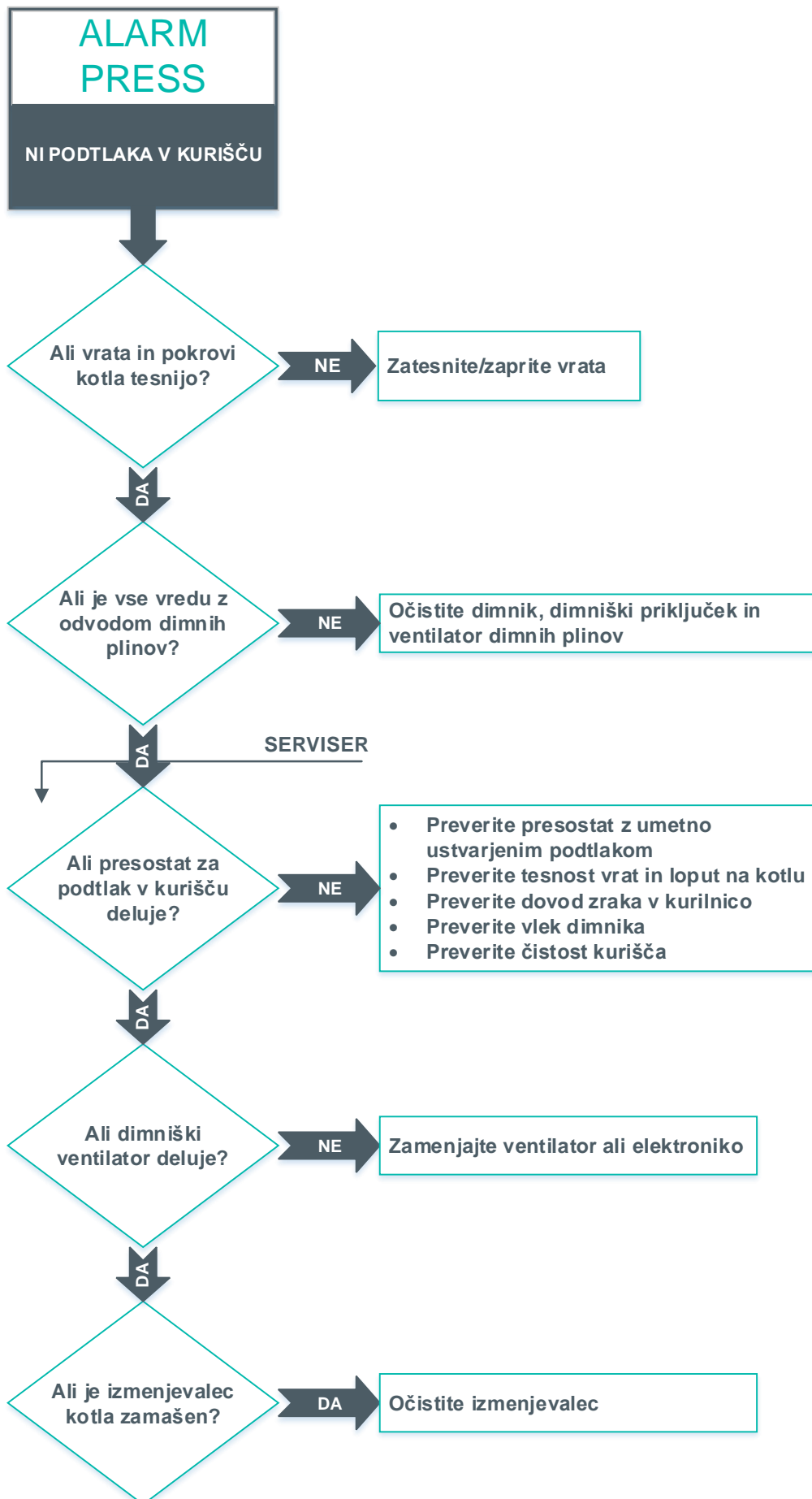

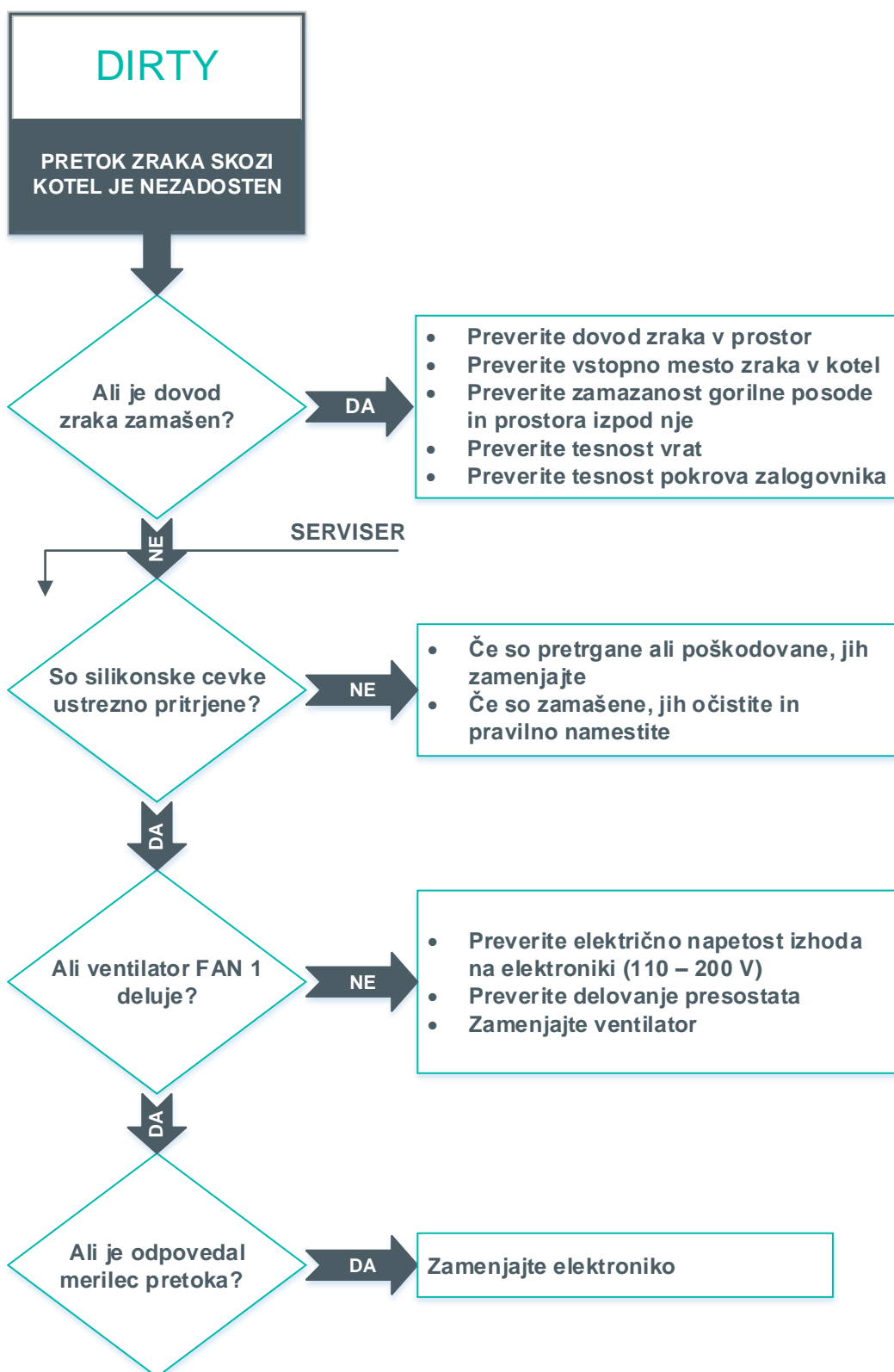

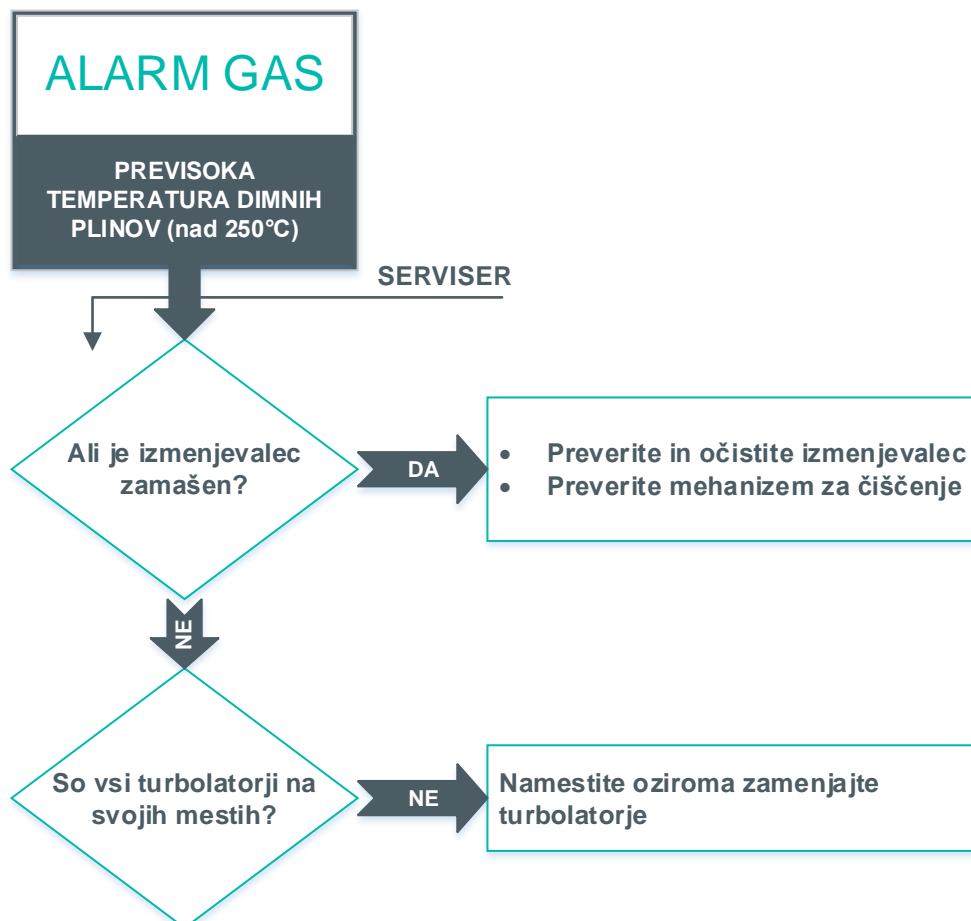
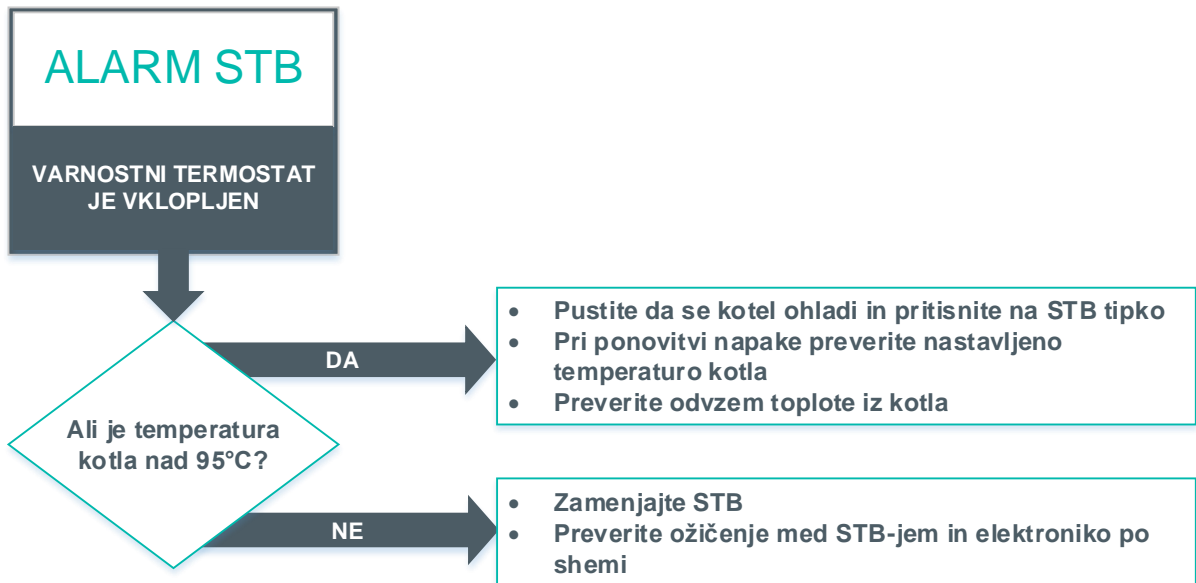



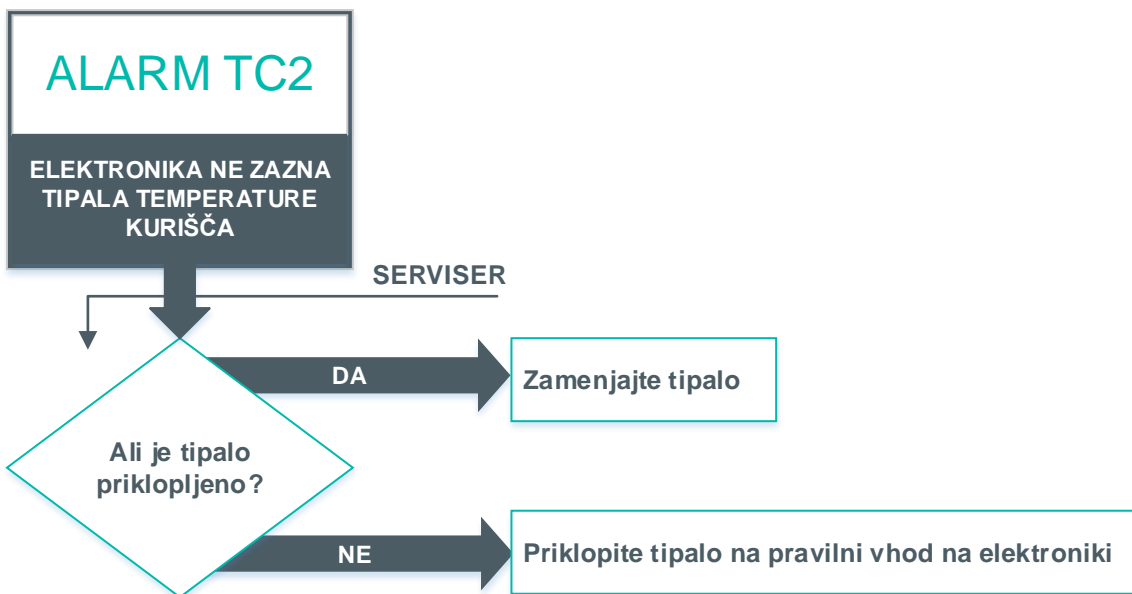
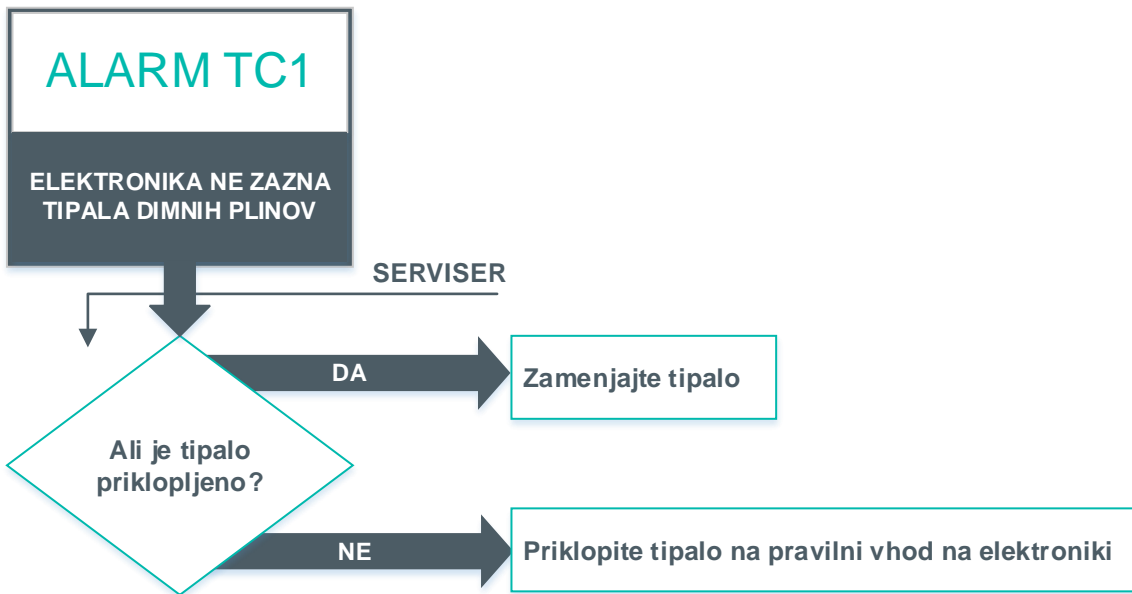

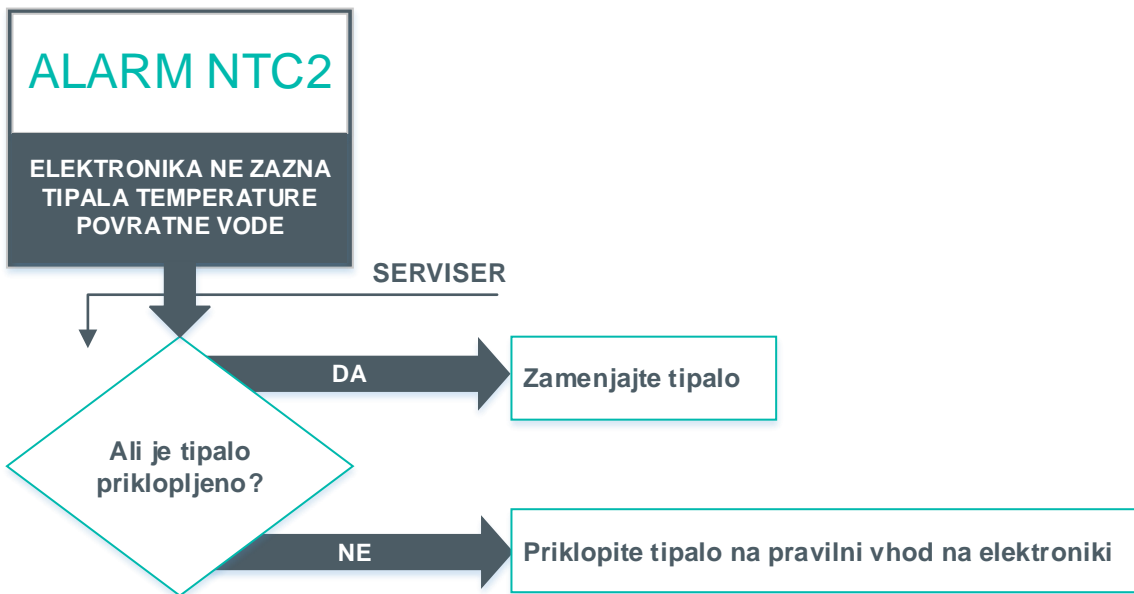
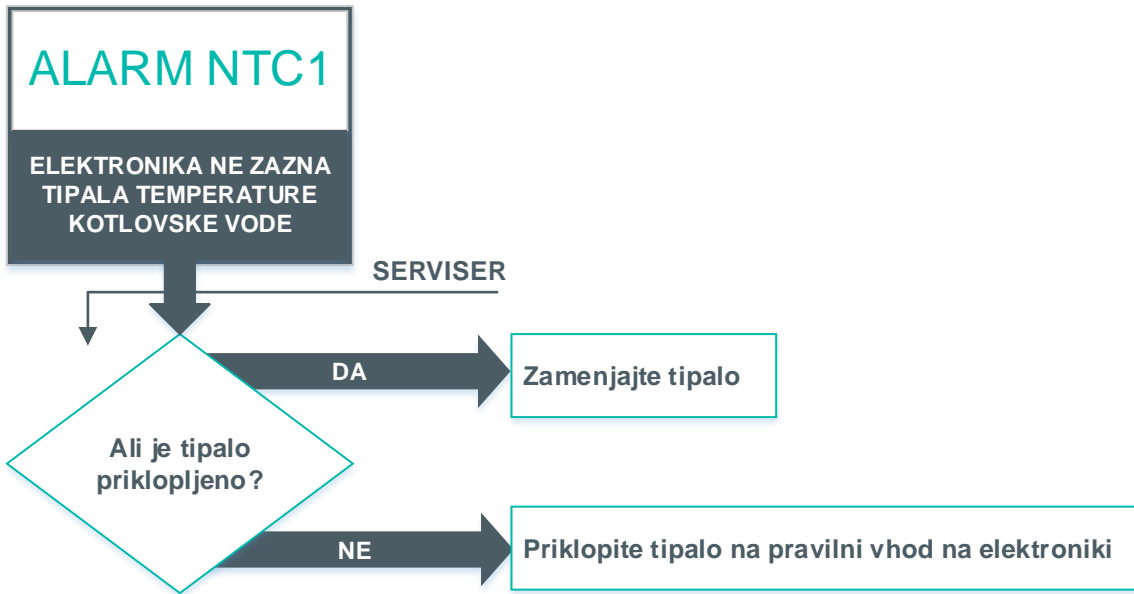

## 13 INFORMACIJE ZA UNIČENJE IN ODSTRANITEV KOTLA

---

Uničenje in odstranitev kotla na pelete je izključno odgovornost lastnika samega, ki mora ravnati v skladu z veljavnimi zakoni v njegovi državi glede varnosti, spoštovanja in zaščite okolja.

Uničenje in odstranitev kotla na pelete se lahko zaupa tretji osebi, ki ima licenco ali pooblastilo za odstranitev in uničenje omenjenih materialov.

**INDIKACIJA:** V vsakem primeru morate upoštevati in spoštovati zakone, ki so v veljavi v državi, v kateri je kotel na pelete vgrajen.



Vsi razstavljeni deli za uničenje morajo biti pravilno odstranjeni:

- odstranite vse električne dele;
- odvojite baterijo od krmilne naprave;
- odvržite baterijo krmilne naprave v skladu z normativi v za to primerne odpadne posode;
- jedro kotla odvržete oziroma prodate kot staro železo.



Zavržen kotel na pelete v dostopnih krajih lahko predstavlja resno nevarnost tako za ljudi kot za živali. Lastnik kotla je vedno odgovoren za nastalo škodo.

*Ko je kotel uničen, je potrebno z njim uničiti tudi CE oznako, Navodila za uporabo, vzdrževanje in vgradnjo, ter ostale dokumente, vezane na kotel.*

# 14 TRAJANJE GARANCIJSKE DOBE

---

S tem je mišljeno časovno obdobje, v katerem zagotavljamo servisiranje, dodatne dele in nadomestne dele. Garancijska doba začne teči od dneva nakupa naprave.

Garancijska doba je v skladu z zakonskimi predpisi.

V primeru prenove modela ali dizajna naprave, lahko uporabnik v zakonsko predpisanem roku naroči starejšo različico delov.

Po tem obdobju bodo spremenjeni deli na voljo le v prenovljeni različici.

## 14.1 GARANCIJSKI POGOJI

**Garancija je veljavna znotraj zakonsko določene garancijske dobe.**

**Garancija ne pokriva stekla ali škode povzročene po nakupu.**

**PROIZVAJALEC SI PRIDRŽUJE PRAVICO DO SPREMEMB.**

### PREGLED:

Da je garancija povsem veljavna, kot je zapisano v direktivi EEC 1999/44/E (42/2002), mora uporabnik pazljivo upoštevati navodila iz tega dokumenta, še posebej:

- uporabljati kotel na pelete po njegovih zmožnostih, v skladu s pogoji iz navodil za uporabo;
- vzdrževati kotel na pelete na marljiv in konstanten način;
- upoštevati vse varnostne ukrepe po veljavnih zakonih;
- izogibati se vsakršnemu nestrokovnemu poseganju v kotel;
- uporabljati samo originalne rezervne dele.

### ČASOVNI POGOJI GARANCIJE:

Garancija za vse izdelke Gorenje velja 24 mesecev od datuma prvega zagona, pod pogojem, da je opravljen redni servisni pregled najkasneje 12 mesecev od datuma zagona.

### SPLOŠNI GARANCIJSKI POGOJI:

1. Izjavljamo:

- da bo izdelek v garancijskem roku deloval brezhibno, če bo uporabljen v skladu z namenom uporabe, ter če bodo upoštevana priložena *Navodila za uporabo in vzdrževanje*;
- da bo v času trajanja garancije podjetje Gorenje preko pooblaščenih servisnih podjetij odpravilo vse okvare-napake, zaradi katerih naprava ne deluje v skladu z namenom, najkasneje v 45 dneh od pisne/ustne prijave okvare oz. napake;
- da bo izdelek, ki ne bo popravljen v omenjenem roku na zahtevo imetnika garancije zamenjan z novim in za čas popravila se bo podaljšal garancijski rok;
- za garancijske pogoje jamči pooblaščen servisno podjetje s podpisom in žigom na izdani garanciji.

2. Uveljavljanje garancije:

Garancija je veljavna pod pogojem, da:

- ima kupec veljaven dokument (račun), ki ga izda prodajalec;
- je kurilno napravo vgradila kvalificirana in/ali izurjena oseba, ki presodi ali naprava ustreza vsem tehničnim karakteristikam sistema, kjer bo naprava vgrajena, in ki mora biti nujno skladna z zahtevami, navedenimi v navodilih;
- se kotel na pelete uporablja v skladu z navodili za uporabo.

Garancijo uveljavite pri prodajalcu, kjer ste napravo kupili.

Pri prijavi okvare navedite točen opis okvare - napake.

### 3. Čas zagotavljanja servisiranja in nadomestnih delov:

- garancijska doba, v kateri zagotavljamo servis in rezervne dele za nemoteno uporabo izdelka je 7 let od dneva prvega zagona;

### 4. Garancija ne velja oz. ne krije škode, nastale zaradi:

- vremenskih, kemičnih ali elektro-kemičnih vplivov; udara strele, elementarnih neizgodb in/ali naravnih katastrof, nepravilne uporabe proizvoda, pomanjkljivega vzdrževanja, sprememb na proizvodu ali brkljanja po proizvodu, neustreznost ali neučinkovitost dimnika in drugi vzroki, ki niso povezani s proizvodom, kot so nepravilna ali neustrezna vgradnja;
- kurjenja materialov, ki ne ustrezajo vrsti materiala, navedenega v teh navodilih;
- vsakršne koli škode, povzročene z/med transportom, zato je potrebno pazljivo preveriti prejeta blago ob dostavi. V primeru da je le-to poškodovano, je potrebno nemudoma obvestiti prodajalca, poškodbo pa zabeležiti na sprejemni dokument ali dobavnico;
- če je zagon izvedlo podjetje, ki ni pridobilo ustreznega pooblastila za Gorenje izdelke;
- če je v izdelek posegala ali popravljala nepooblaščen oseb;
- če uporabnik ne upošteva navodil za uporabo in vzdrževanje;
- če se pojavijo napake ali okvare na ogrevalni napravi Gorenje zaradi napak na opremi drugih proizvajalcev.

Odgovornost podjetja Gorenje d.d. je omejena na dobavo naprave. Enota mora biti pravilno vgrajena v skladu z navodili proizvajalca, kot tudi z veljavnimi zakoni. Vgradnjo mora izvesti kvalificiran kader, ki ga določi proizvajalec oziroma zastopnik/trgovec<sup>1</sup> (in/ali pod njegovim nadzorom in odgovornostjo), ki prevzame vso odgovornost za končno vgradnjo in naknadno pravilno delovanje vgrajenega proizvoda. V primeru neizpolnjevanja pogojev, podjetje Gorenje d.d. ni v nobenem primeru odgovorno.

<sup>1</sup> Kot zastopnik/trgovec se smatra vsaka fizična ali pravna oseba, ki je pooblaščen za prodajo artiklov končnim uporabnikom te garancije.

**OPOMBA:** Gorenje d.d. ne odgovarja za kakršno koli nastalo škodo ter posledice, tudi v primeru ko so le-te posledica zamenjave nepravilno delujočega dela na kotlu. Gorenje d.d. zagotavlja, da so vsi njeni proizvodi izdelani iz materialov najvišje kvalitete in po delovnih procesih, ki zagotavljajo popolno učinkovitost. Če se v primeru normalne uporabe pojavi kakršen koli pokvarjen ali slabo delujoč del, ga je potrebno zamenjati.

### DELI, PODVRŽENI NORMALNI OBRABI, KI JIH GARANCIJA NE KRIJE, SO:

- tesnila in litoželezni deli, ki ne kažejo nobenega znaka napake, ki bi jo lahko pripisali proizvodni napaki;
- spremembe barve, razpoke in majhne dimenzijske spremembe niso utemeljene in ne predstavljajo razloga za vračilo, ker so posledica naravne karakteristike materialov.

### ODGOVORNOST:

Gorenje d.d. ne priznava nobene povrnitve stroškov za direktno ali indirektno nastalo škodo zaradi proizvoda ali v odvisnosti od proizvoda.

### SERVIS MED GARANCIJSKIM ROKOM:

**Gorenje d.d. odgovarja na probleme, vezane na garancijo, samo preko svojih pooblaščenih oseb.**

Za čas nedelovanja kotla na pelete podjetje Gorenje d.d. ne priznava nikakršnega povračila stroškov. *Gorenje d.d. ni odgovorno za napake v navodilih. Pridržujemo si pravico do sprememb brez kakršnega koli predhodnega obvestila.*

## 15 NAVODILA ZA PRVI ZAGON

AQUA ECOLOGIC 15C je kurilna naprava za ogrevanje s peleti. Prednost kurilne naprave AQUA ECOLOGIC 15C je v najnaprednejši tehnologiji, ki omogoča izjemno natančno doziranje izgorevalnega zraka, samodejno prepoznavanje dimniškega vleka in prepoznavanje kurilne vrednosti pelet in na tej osnovi vzdrževanje optimalnega izgorevanja v vseh pogojih delovanja. V primerih, ko kaj od omenjenih dejavnikov ne ustreza, bo kurilna naprava na zaslonu izpisala alarm za neustreznost oziroma napako za pomanjkljivost (primer: če je zamašen dimnik oziroma, če ne zagotavlja odvoda dimnih plinov, bo naprava izpisala na zaslonu »ALARM PRESS«).

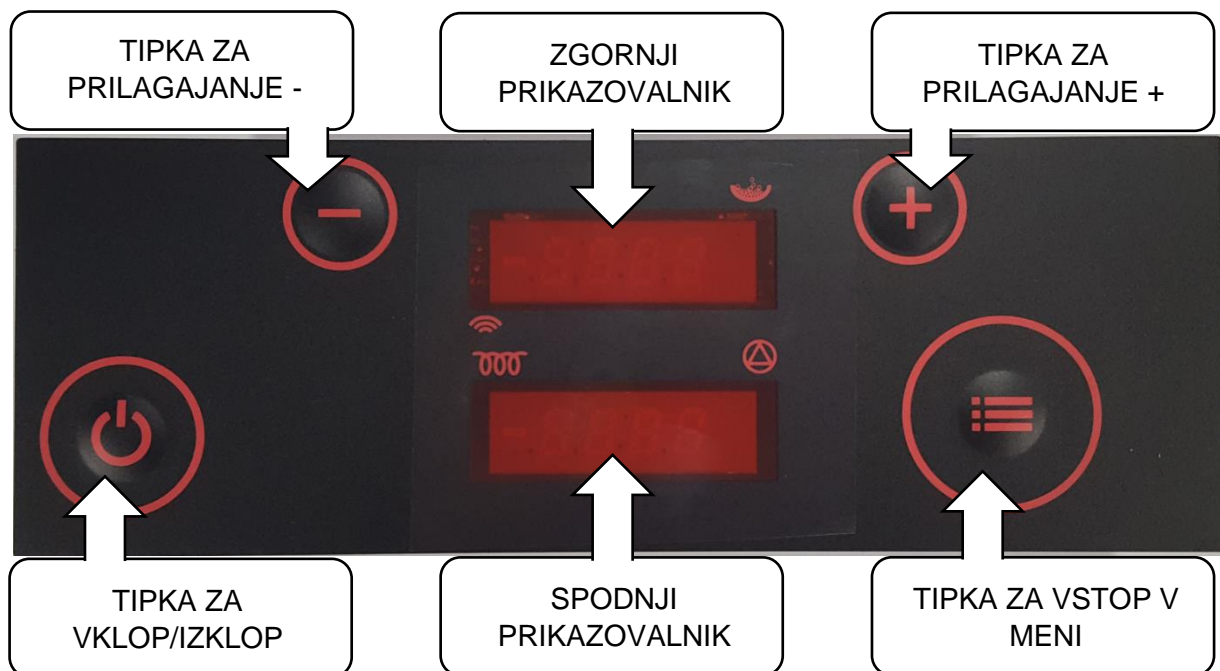

Slika 14: pregled tipk na tipkovnici

Tipka	Funkcija
	<b>Tipka VKLOP/IZKLOP</b> Daljši pritisk vključi/izključi kotel. Kratek pritisk povrne osnovni prikaz.
	<b>Tipka GOR</b> Pritisk med delovanjem poveča nastavljeno moč. Ob predhodnem kliku na tipko MENI, s to tipko povečujemo željeno temperature vode v kotlu. V menijskem način s pritiskanjem izbiramo želeni podmeni.
	<b>Tipka DOL</b> Pritisk med delovanjem zmanjša nastavljeno moč.

---

Ob predhodnem kliku tipke MENU, s to tipko zmanjšujemo želeno temperature vode v kotlu. V menijskem način s pritiskanjem izbiramo želeni podmeni.

---

### Tipka **MENI**

S kratkim pritiskom v osnovnem prikazu se prikaže nastavljena vrednost temperature vode v kotlu in jo nato lahko spreminjamo s tipkama + in -.

S pritiskom, daljšim od 2 sekund, aktiviramo menijski način.

S pritiskom, daljšim od 4 sekund, vstopimo v napredne menijske nastavitve. Z držanjem pritisnjene tipke izbiramo posamezne podmenije.

Za izbor parametra v podmenijih uporabljamo tipke GOR in DOL. S kratkim pritiskom na tipko MENI prične utripati nastavljena vrednost parametra, ki jo lahko spremenimo s tipkama GOR in DOL.

S kratkim pritiskom na tipko VKLOP/IZKLOP ali držanjem tipke MENI do preleta vseh menijskih izbir, se vrnemo v osnovni prikaz.



Ko inštalater izvede priključitev na sistem centralnega ogrevanja, na dimnik z dimniškim priključkom in na električno omrežje skladno z navodili za inštalaterja, je kotel pripravljen za zagon. Po preverjenih detajlih iz navodil za inštalaterja, lahko kurilno napravo s pritiskom na tipko **VKLOP/IZKLOP** spusti v delovanje inštalater, ki je napravo inštaliral.

Pri prvem zagonu mora biti pozoren na redosled dogodkov (izpisov na zaslonu):

- pritisk tipke VKLOP/IZKLOP za 3 sekunde, na zaslonu se izpiše ON, takoj za tem
- »**Test fire**« ki traja 10 sekund, nato preide v:
- »**Heat up**« - hitro polnjenje gorilne posode s peleti, izmenično se prikazuje *P0 d5* (na zgornjem zaslonu) in spreminjajoče se temperature; b- temperatura ogrevne vode v kotlu, samo številka - temperatura dimnih plinov in r- temperatura povratnega voda (na spodnjem zaslonu) nato preide v:
- »**Fuel igni**« - prižiganje kurilne naprave (pri prvem zagonu lahko faza vžiganja traja dlje časa tudi do 10 min), ki traja približno 5 minut, tudi tu se izmenično prikazuje na zgornjem zaslonu *P0 d5* in spodaj temperature, nato preide v:
- »**Igni test**« - preverjanje vžiga, tudi tu se menjuje zapis na zaslonu *igni test* in *P0 d5* in na spodnjem zaslonu temperature, ko zaključi preverjanje vžiga preide v:
- »**Burn**« - delovanje kotla, na zgornjem zaslonu izpiše Burn, na spodnjem se pa spreminjajo b-temperature ogrevne vode v kotlu, dimnih plinov in r-temperatura vode v kotlu:
- Led dioda v zgornjem zaslonu zgoraj desno signalizira kdaj deluje reduktor za doziranje peletov (ko dioda zasveti takrat reduktor dozira pelete v gorilnik in obratno: če lučka ne gori, reduktor ne deluje).
- Led dioda na spodnjem zaslonu spodaj desno signalizira, kdaj kotel pošilja napetost črpalke - kdaj črpalka deluje (ko led dioda sveti, takrat je tudi napetost na izhodu za

črpalko. Posledično mora tudi črpalka delovati in obratno: če led dioda ne sveti, črpalka ne deluje),

- ko se temperatura ogrevne vode približuje nastavljeni temperaturi, kurilna naprava prične z modulacijo oziroma z regulacijo/zmanjševanjem moči. V tem stanju se na zaslonu izpisuje »**regu H2O**«, izmenično se na zgornjem zaslonu prikazuje moč (P je stopnja na kateri kotel deluje, d je stopnja na katero je kotel nastavljen), na spodnjem zaslonu pa temperature.
- »**Cool flui**« je stanje ugašanja, ki se izpiše na zaslonu v trenutku, ko je kurilna naprava dosegla nastavljeno temperaturo ogrevne vode v kotlu z dodatkom za regulacijo (če je temperatura ogrevne vode nastavljena na 70 °C, bo kotel prešel v stanje »cool flui« pri 75 °C). Ko kotel zaključi s stanjem »Cool flui« pomeni, da se je ogrevna voda v kotlu ohladila in preide v stanje:
- »**Test fire**« in postopek vžiganja se ponovi.

Za kontrolo informacij o delovanju kurilne naprave je potrebno z menijem vstopiti v program informacij (prikazani podatki so zgolj informacijskega značaja). V meni se vstopi z dolgim pritiskom na tipko MENI, ko se na zaslonu izpiše »tH2O« se tipko izpusti. S tipkama + in - izbiramo željeno informacijo.

Prikazane informacije so:

- **tH2O** temperatura ogrevne vode v kotlu
- **rH2O** temperatura ogrevne vode na povratku,
- **tFLU** temperatura dimnih plinov ((H<sub>2</sub>O) + 30-90 °C),
- **tChb** temperatura ognja v izgorevalni komori (615 °C +- 40 °C),
- **floU** vnos zraka-kisika v kurilno napravo (480 °C +- 40 °C),
- **Fanl** napetost na ventilatorju 1 (130 V +- 15 V),
- **Fedl** odstotek doziranja peletov v gorilnik (70 % +-20 %)

Ko se zaključi pregled informacij je pred izhodom iz informacij potrebno poiskati s tipkama gor in dol informacijo »tH2O« in ko jo najdemo, lahko s kratkim pritiskom na tipko VKLOP/IZKLOP izstopimo v prvotno stanje.



PRIDRŽUJEMO SI PRAVICO DO SPREMEMB, KI NE VPLIVAJO NA FUNKCIONALNOST  
APARATA.

Navodila za uporabo so na voljo tudi na naših spletnih straneh  
<http://www.gorenje.com>.

# INSTRUCTIONS FOR USE, MAINTENANCE AND INSTALLATION

## **INSTRUCTIONS FOR CONNECTING, OPERATION, AND MAINTENANCE OF THE BOILER**

*Heating devices (in this manual they are called "boilers") by Gorenje d.d. (in this manual titled Gorenje) are assembled and tested in accordance with the safety and applicable measures, and regulations of the European Community.*

*This manual is intended for users of the boilers, contractors who install the boilers, operators and workers for boiler maintenance that is shown on the front page of the manual.*

*If you do not understand something in this manual, please contact our professional services or an authorized service center. In doing so, always specify the number of the chapter where there is some ambiguity.*

*Printing, translation and reproduction, even in part, of this manual is subject to licensing by Gorenje, which means that Gorenje must approve these actions. Technical information, figures, and specifications in this manual must not be given to a third party.*

### **WARNING:**

**IMPORTANT: Connecting the appliance to the electrical installation must be carried out by qualified and authorized persons in accordance with applicable regulations. This appliance is not intended for use by persons (including children) with reduced physical, motor, and mental capabilities, or to persons with a limited knowledge and experience in the absence of the person responsible for their safety or care.**

### **DOUBLE COMBUSTION SYSTEM**

The flame obtained by proper combustion of the pellet in the boiler emits the same amount of carbon dioxide (CO<sub>2</sub>), which would be freed as a result of the natural decay of wood.

The amount of carbon dioxide (CO<sub>2</sub>) obtained through combustion or decomposition of plant mass corresponds to the amount of carbon dioxide (CO<sub>2</sub>) which the plant mass is able to obtain from the environment and to transform it into air and carbon of the plants during its entire lifetime.

The use of non-renewable fossil fuels (coal, oil, gas), contrary to what happens with the wood, releases into the atmosphere huge amounts of carbon dioxide (CO<sub>2</sub>), that have been gathering up for millions of years, creating a greenhouse effect. The use of wood as fuel is therefore perfectly balanced with the environment, because the wood as a renewable fuel is in ecological harmony with nature.

Using the principle of clean combustion, we fully achieve these objectives, and so Gorenje has directed its development and all activities towards fulfilling this goal.

What do we consider clean combustion and how does it work?

Controlling and adjusting the primary air and injecting the secondary air causes secondary combustion, or the so-called post-combustion, which provides a secondary flame that is by its nature lighter and stronger than the primary flame. The addition of a new oxygen (inserted through the air) allows further combustion of gases that are not completely burned. This significantly increases the thermal efficiency and reduces harmful emissions of carbon monoxide (CO), because the incomplete combustion is minimized. These are the basic characteristics of these boilers and other products of Gorenje.

## TABLE OF CONTENTS

1	WARNINGS	1
2	TECHNICAL CHARACTERISTICS	4
2.1	DIMENSIONS OF BOILER	5
3	PURPOSE OF INSTRUCTIONS FOR USE	6
3.1	POSODOBITVE	6
4	ODGOVORNOST PROIZVAJALCA	6
4.1	SPLOŠNI POGOJI ZA UPORABO	6
4.2	BASIC PREVENTIVELY REQUIRED STANDARDS	7
4.3	TRANSPORTATION AND HANDLING OF PELLET BOILER	7
4.4	RESPONSIBILITY OF INSTALLER	7
5	INSTALLATION	8
5.1	PLACEMENT	8
5.2	EXTRACTION OF SMOKE GASES	11
5.3	INSULATION AND DIAMETER OF HOLES IN THE ROOF	13
5.4	AIR INLET	13
5.5	ELECTRICAL CONNECTION	14
6	FIRST START UP	15
7	SAFETY WARNINGS	16
7.1	SAFETY WARNINGS FOR MAINTENANCE STAFF	16
7.2	SAFETY WARNINGS FOR USER	16
8	INSTRUCTIONS FOR SAFE IGNITION AND CLEANING OF BOILER	17
8.1	REGULAR MAINTENANCE AND CLEANING OF BOILER	17
8.2	CONTROL AND PARTS REQUIRED MAINTENANCE	19
8.3	ADDITIONAL MAINTENANCE	19
9	IMPORTANT SAFETY INFORMATION	20
10	PELLET QUALITY IS VERY IMPORTANT	20
10.1	STORING PELLETS	20
11	DESCRIPTION AND OPERATION OF CONTROL DEVICE	21
11.1	DESCRIPTION OF KEYBOARD WITH DISPLAY	21
11.2	BOILER DURING OPERATION	23
11.3	BOILER SHUTDOWN	24
11.4	BOILER ACTIVATION	24
11.5	TIME PROGRAMME SETTING	25
11.6	INDICATIONS AND MESSAGES ON DISPLAY	26
12	MENU	28
13	ALARM STATUSES	29

14	INFORMATION REGARDING DESTRUCTION AND DISPOSAL OF BOILER	36
15	TRAJANJE GARANCIJSKE DOBE	37
15.1	WARRANTY CONDITIONS	37
16	INSTRUCTIONS FOR FIRST START-UP	39

# 1 WARNINGS

---



## ATTENTION

DISCARD ALL PACKAGING OUT OF REACH OF CHILDREN. DANGER OF SUFFOCATION WITH BAG, FOIL, POLYSTYRENE ETC.

---



## ATTENTION

Smoke gas discharge **MUST NOT BE CONNECTED TO:**

- Flue pipe, used by other combustion devices (boilers, stoves, fireplaces etc.);
  - Air extraction systems (hoods, air extraction fans etc.).
- 



## ATTENTION

Installation of draught closing valves is prohibited!

Flue connection Ø 80 mm from pellet boiler to flue pipe should be:

- no more than 5 m long (in case of longer connection, dimension of connection pipe must increase to Ø 130 mm);
  - each 90° joint requires a 1 m shorter flue connection;
  - each joint must be fitted with doors for cleaning;
  - connections between pipes must be sealed.
- 



## ATTENTION

If there is too much resistance in extraction system (many joints, improper end fitting, bottlenecks etc.), extraction of smoke gases is not provided for.

Therefore, connection pipes and joints must be increased to a greater dimension – Ø 130 mm. If the flue does not ensure appropriate extraction of smoke gases, it can also come do improper operation and, consequently, to alarm from boiler. It is advisable that the flue is inspected by an expert before installing boiler.

---



## ATTENTION

Never turn off the boiler by pulling the electrical cable from the socket, while fire is still burning in the boiler. This could damage the boiler and seriously jeopardize its functioning.

---



## ATTENTION

Extraction of smoke gases must be earthed in accordance with regulations in force. (Earthing connection is required by law). Earthing must be independent of combustion unit

---

**ATTENTION**

When the boiler installation is finished, it is mandatory to perform measurements of smoke gases discharge.

---

**ATTENTION**

The pellet boiler operates by creating negative pressure in the combustion chamber. Therefore, ensure that the extraction of smoke gases is thermally sealed. Upon first start-up (minimum operation of boiler – 1 hour), paint evaporates fumes, which have unpleasant odour. Therefore, ventilate the room afterwards.

---

**ATTENTION**

Pazite na tesnilno vrvico pod robom kurilne posode, da ni poškodovana. V primeru, da je tesnilna vrvica poškodovana, se obrnite na pooblaščen servis.

---

**ATTENTION**

**DURING PELLET BOILER OPERATION, CHILDREN ARE PROHIBITED TO COME NEAR OR PLAY WITH IT!**

---

**ATTENTION**

Be careful that the sealant rope under the edge of combustion chamber is not damaged. If the sealant rope is damaged, contact an authorized service centre.

---

**ATTENTION**

Ensure that the pellet boiler and ashes in it are cool before cleaning.

---

**ATTENTION**

In the event of fire in the flue pipe, all persons and animals must leave the area, then immediately disconnect power supply from the main switch or socket (if it is possible without risk) and call the fire department.

---

**ATTENTION**

Do not use fine cut wood to ensure operation and safety of the boiler.

---

**ATTENTION**

Do not use the pellet boiler as an incinerator.

---

**ATTENTION**

Persons with back injuries and pregnant women should avoid lifting pellet bags.

---



**ATTENTION**

The manufacture shall in no way be held liable for damages arising from the use of poor quality pellets, as well as for poor functioning of the boiler due to poor quality of used pellets.

---



**ATTENTION**

Pellets should be in accordance with DIN 51731, DIN plus, Ö-Norm M-7135 or other comparable European standards.

---



**ATTENTION**

**PELLETS SHOULD NOT BE STORED NEAR THE PELLET BOILER.** Keep them at least 50 cm away.

---



## 2 TECHNICAL CHARACTERISTICS

---

	Minimal	Nominal
Thermal power	4,97 kW	17,13 kW
Efficiency	90,6 %	93,83 %
Pellet consumption per hour	1,13 kg/h	3,77 kg/h
Burning time with 1 filling of container (approx.)	39,8 h	12 h
CO emissions (at 13 % O <sub>2</sub> )	136 mg/Nm <sup>3</sup>	56 mg/Nm <sup>3</sup>
Average temperature of smoke gases	58 °C	117,1 °C
Mass flow of smoke gases	3,9 g/s	8,4 g/s
Fuel	Peleti A1	
Boiler class according to EN 303-5:2012	5	
Flue connection	Ø 80 mm	
Water volume in boiler	42 l	
Boiler water temperature	65 °C – 80 °C	
Highest boiler water temperature	90 °C	
Minimum return water temperature	50 °C	
Maximum permitted work pressure	2,5 bar	
Boiler resistance $\Delta T = 20$ °C	32 mbar	
Firebox volume	30,6 l	
Weight	220 kg	
Pellet container	~ 55 Kg	
Flue draught	0,10 ( $\pm$ 0,05) mbar	
Napajanje	220 V	
Current at maximum electrical consumption during boiler operation	1,80 A	
Frequency	50 Hz	
Maximum consumption of power during boiler operation	98,91 W	
Maximum consumption of power during boiler ignition	293 W	
Safety level	IP20	

Boiler operates with two fans

Boiler operates only in manner of negative pressure combustion

Boiler operates without condensation conditions

Noise does not exceed 60 dB

CO emissions at 13% O<sub>2</sub> 56 *mg/N<sub>m</sub>3*

OGC emissions at 13% O<sub>2</sub> 2,6 *mg/N<sub>m</sub>3*

Ash at 13% O<sub>2</sub> 17,3 *mg/N<sub>m</sub>3*

## 2.1 DIMENSIONS OF BOILER

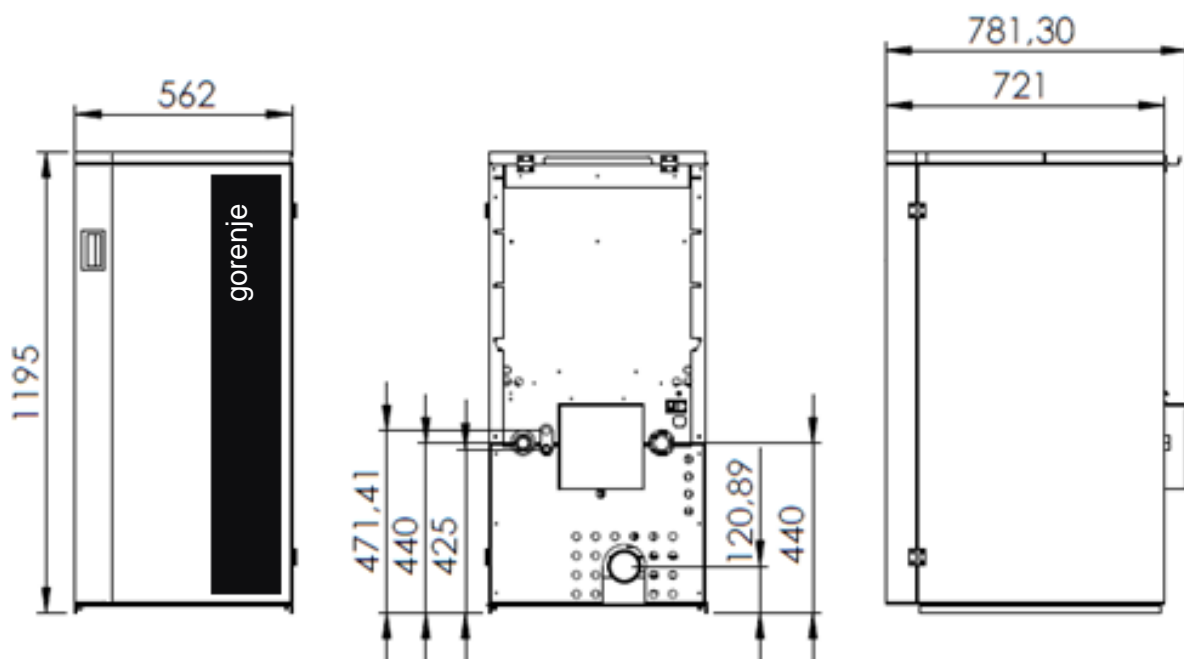

## 3 PURPOSE OF INSTRUCTIONS FOR USE

---

The purpose of instructions for use is that the user takes all necessary measures and prepares all required equipment to ensure safe and proper use of combustion device.

### 3.1 POSODOBITVE

These instructions reflect the state of the product at the moment the boiler is produced. Instructions are not applicable for products, which are already present on the market with corresponding technical documentation and cannot be considered as insufficient or inadequate after any modification, adaptation or application of new technologies on newer products.

The content of this booklet must be carefully read and heeded to. All of the information, contained in this booklet, is necessary for correct installation, use and maintenance of you boiler.

The instructions must be stored carefully and safely. Instructions for use, maintenance and installation are a component part of pellet boiler.

If the pellet boiler changes ownership to another person, this person must also receive these instructions for use, together with the boiler.

If the instructions get lost, request for a new copy of instructions from the manufacturer, authorized reseller or repairman.

## 4 ODGOVORNOST PROIZVAJALCA

---

In providing these instructions, Gorenje d.d. rejects any civil or penal liability, direct or indirect, due to:

- accidents caused by non-compliance with standards and specifications from these instructions;
- accidents caused by prohibited or incorrect use by the user;
- accidents caused by modifications and repairs not authorized by manufacturer Gorenje d.d.;
- poor maintenance;
- unforeseeable events;
- accidents caused by use of non-original or improper spare parts.

The installer is fully responsible for installation.

### 4.1 SPLOŠNI POGOJI ZA UPORABO

The pellet boiler can only be used by adults and responsible persons who have the necessary technical skills for regular maintenance of electrical and mechanical parts of the boiler.

DO NOT LET THE CHILDREN PLAY NEAR AN OPERATING BOILER WITHOUT CONTROL. THE BOILER IS NOT A TOY.

## 4.2 BASIC PREVENTIVELY REQUIRED STANDARDS

Product Gorenje Aqua Ecologic 15C is manufactured in accordance with the following standards:

- DIREKTIVA ES O STROJIH (2006/42/CE);
- DIREKTIVA ES O NIZKONAPETOSTNI OPREMI (2014/35/ES);
- DIREKTIVA ES O ELEKTROMAGNETNI ZDRUŽLJIVOSTI (2014/30/ES);

Harmonised standards\_

- EN 303-5:2012
- EN 60335-1:2012+A11:2014
- EN 6100-6-3:2007+A1:2011
- EN ISO 12100:2010
- EN 60335-2-102:2006+A1:2010
- EN 60204-1:2006+A1:2009
- EN 60529:1992+A2:2013

## 4.3 TRANSPORTATION AND HANDLING OF PELLET BOILER

When moving the boiler, pay attention to your safety.

Before transport and handling of the boiler, which must be performed in complete safety, make sure that the lifting capacity of transport equipment suffices. Avoid sudden and/or abrupt movement of boiler.

## 4.4 RESPONSIBILITY OF INSTALLER

It is the responsibility of the installer to check adequacy of installation and pipeline, ensure air intake for combustion, ensures regulated distances and all other solutions, required for installation of the pellet boiler.

It is the responsibility of the installer to ensure compliance with local legislation in force in the place of pellet boiler installation.

Use of the pellet boiler must conform with instructions, provided in Instructions for use, maintenance and installation, and all safety standards, specified by local legislation in the place of pellet boiler installation.

Standard UNI 10683 defines duties of installer. The installer must check:

- type of device to be installed;
- adequacy of space for installation of unit, reflected by minimum required size of the space, in which the pellet boiler will be installed;
- instructions of the manufacturer about heating device, regarding requirements of smoke gases outlet;
- flue pipe internal diameter, the material it is made of, is it straight or even and that there are no obstructions;
- height and, if required, vertical extension of flue pipe;
- existence and suitability of flue pipe cover resistance;
- possibility of outside air intake;
- possibility of simultaneous use of generator for connection with other equipment.

If the results of all above provided checks are positive, installation may proceed. Carefully heed to instructions provided by the manufacturer, as well as safety and fire prevention standards in force.

After the first start-up of the boiler, perform a minimum 30-minute test of operation to check all required demands.

When the installation is complete, the installer must provide the customer with the following:

- instructions for use, maintenance and installation from the manufacturer (if not included in the unit);
- required documentation in accordance with standards in force;
- perform training of customer for operation and regular maintenance and cleaning of the device.

## 5 INSTALLATION

---

Responsibility for installation work in the space is entirely upon the customer.

Before proceeding with installation, the installer must comply with all required legal safety standards, especially:

- Check that norms regarding pellet boiler installation meet local, national and European norms
- Heed to requirements set forth in this document
- Check that pipes and air intake are compliant with the type of installation
- Do not make temporary electrical connections by using unsuitable cables
- Check earthing of electrical system
- Always use individual safety equipment and all legally required protection
- Always allow sufficient space for maintenance work
- Acquire consent of chimney sweep for connection of boiler to flue
- Perform measurement of smoke gases outlet after finished installation.

### 5.1 PLACEMENT

It is advisable to remove pellet boiler packaging only when it is in the place of installation.

If the adjacent walls and/or flooring are made of material that is not heat resistant, suitable protection must be provided using insulating, non-combustible material.

For protection of flooring, made of flammable material, we advise installing a metal plate with thickness 3 to 4 mm under the boiler, which protrudes at least 30 cm out from the front of the pellet boiler.

Pellet boiler must be installed in accordance with drawing that defines distances from walls (**figure 1**).

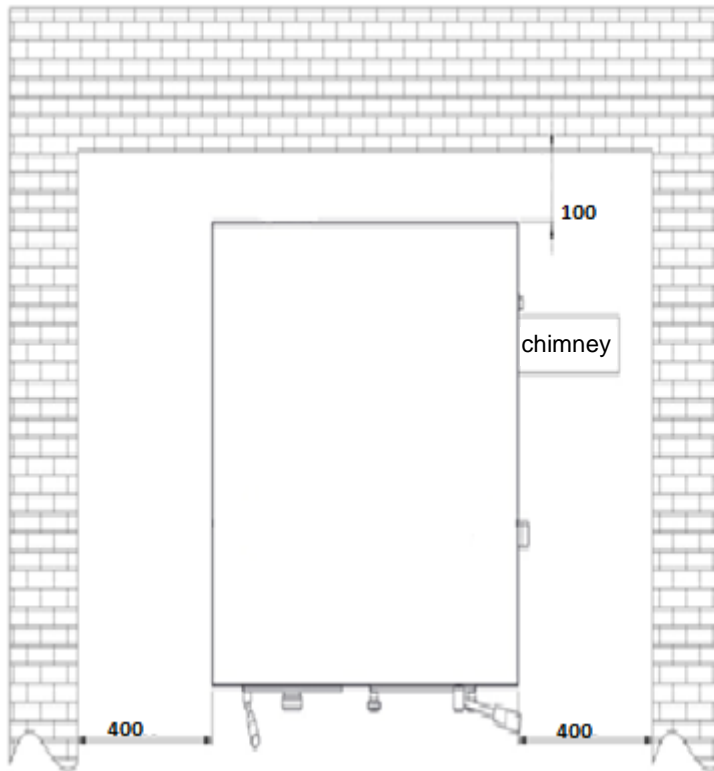

EXAMPLE 1

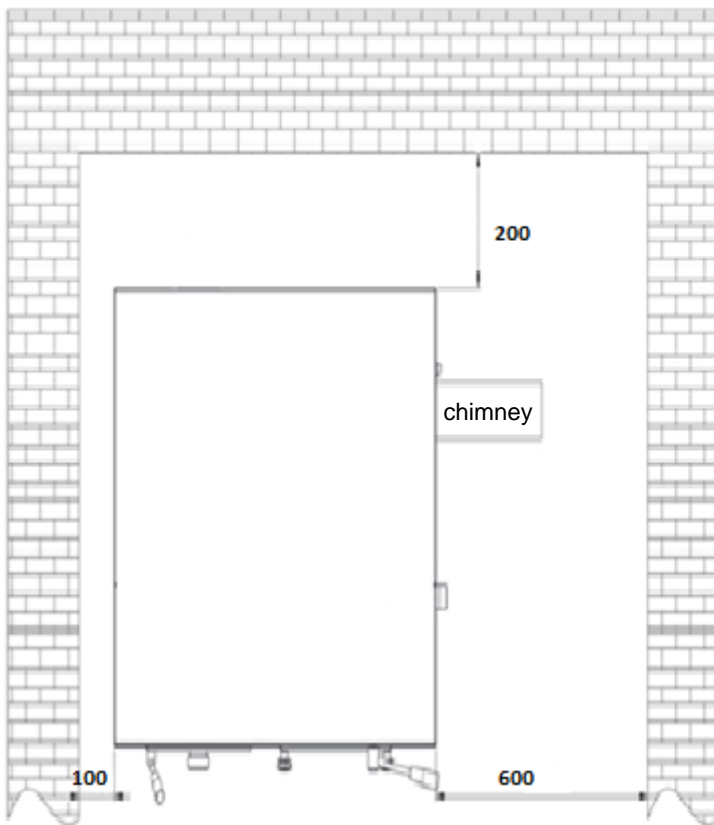

EXAMPLE 2

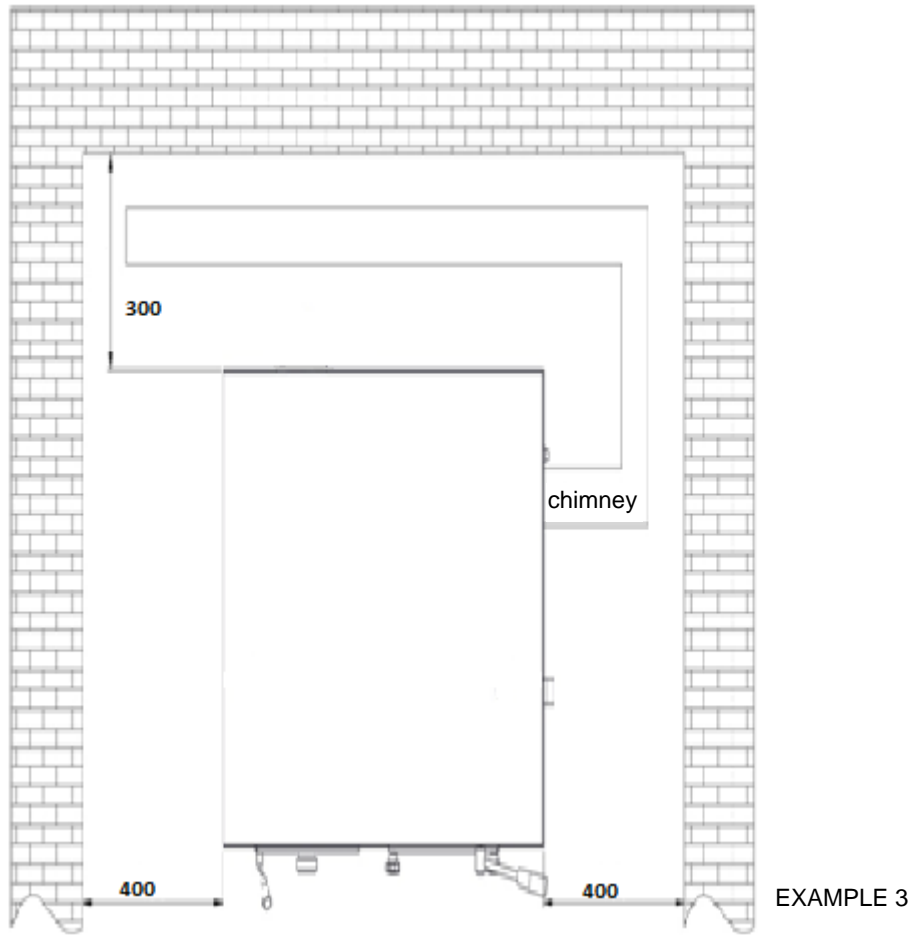

**Figure 1: Minimum distance of boiler from boiler room walls**

If the pellet boiler is installed in a boiler room, where there are other devices, which drain air (other boiler, various suction fans etc.), make sure that the volume of air intake is sufficient for safe operation of combustion device. If the smoke duct passes through a ceiling, it must be properly insulated using diaphragm of non-combustible insulation material.

When the pellet boiler is placed, it must be levelled with support feet (horizontal positioning). Smoke gases extraction system from pellet boiler functions on the basis of negative pressure in the boiler and barely perceivable pressure in flue connection pipe  $\varnothing$  80 mm. It is very important that the smoke gases extraction is sealed.

Layout and structure of the space, where the flue is installed, needs to be analyzed. If it passes through walls and/or roof, it must be properly installed in accordance with fire prevention safety standards.

Ensure that there is enough air for proper combustion in the space, where the pellet boiler is installed. If boiler lacks oxygen/air, the boiler displays an alarm. External supply or intake of external air requires a pipe with a diameter of at least 110 mm with maximum length of 10 m. Each 90° joint requires a deduction of 1 m in line length. If the air supply is longer, diameter of air intake pipe must be increased.

In case of a grid on the facade, draught opening must be 100 cm<sup>2</sup> or larger.

The device operates at 220 V – 50 Hz. Make sure that the electrical cables are not laid under the boiler, that they are far away from hot surfaces and that they do not touch sharp parts, which could damage them. If the pellet boiler is under electrical overload, life expectancy of electrical component greatly reduces.

## 5.2 EXTRACTION OF SMOKE GASES

Extraction of smoke gases must be in accordance with regulations in force. Pipes for smoke gases must not be connected to other discharge pipes of any other combustion device (**figure 2**). It is prohibited to set up extraction of smoke gases into closed and/or semi-closed spaces, e.g. garage, narrow passages or hallways, underpasses or any other similar spaces. If the flue connection is not suitable, it must be implemented in accordance with previously provided requirements (point 3.1).

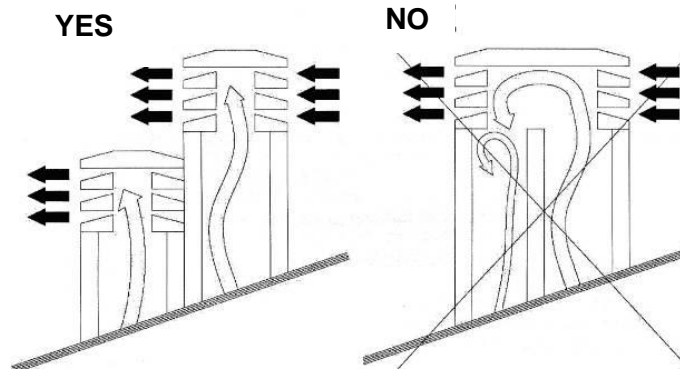

**Figure 2**

Regarding dimensions and material, from which it is made, the flue pipe must conform to standards UNI 9615-9731, UNI 10683 - EN1856-1.

Flue pipes in poor condition and/or made of unsuitable materials (asbestos, zinc sheet metal etc., with rough or porous surfaces) are prohibited by law and compromise proper boiler operation.

Smoke can be extracted through a traditional flue pipe (see figure below) provided that the following rules are met:

- Check condition of flue pipe maintenance. For proper maintenance and/or restoration contact chimney sweep service.
- Extraction of smoke gases can be connected directly to flue pipe only if it has a maximum dimension of 20 x 20 cm or diameter of 20 cm and is fitted with inspection hole.
- If the flue pipe is of greater dimensions, a stainless pipe (with required diameter) with proper insulation must be installed into it.
- Make sure that the connection with the flue pipe is properly sealed.
- Avoid contact with flammable material (such as wood ashes), and, in any case, insulate them with fire-resistant material.

When using connections between the pellet boiler and flue pipe, it is mandatory to use joints with cleaning doors (**figure 3**). Use of joints with cleaning doors enables regular cleaning without the need to disassemble pipes. Exhaust fumes in flue connection are under slight pressure. Therefore, it is compulsory to check that the cover for cleaning ash is completely hermetically closed and that it remains in this state after each cleaning. Ensure proper reassembly and check condition of the seal.



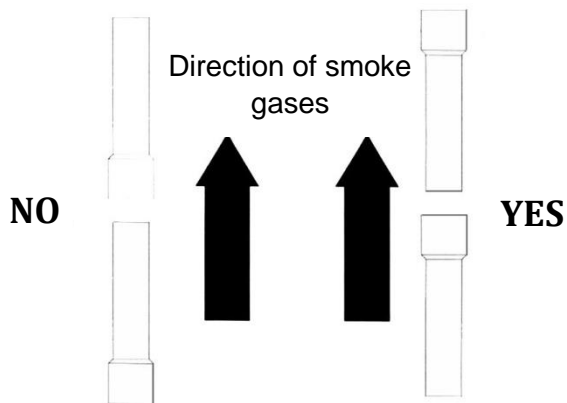

**Figure 3: Cleaning unit**

Connection between pipes must be always made with male fitting turned upwards (**figure 4**).

It is advisable to avoid using horizontal connections of pipes to flue. If this is not possible, the pipes must not be installed in a downwards angle, but at an upwards angle of at least 5 % (**figure 5**). Horizontal installation of pipes must not exceed 2 m in length.

It is not advisable to connect the pipe from the pellet boiler directly to flue with horizontal pipe, longer than 1 m.



**Figure 4**

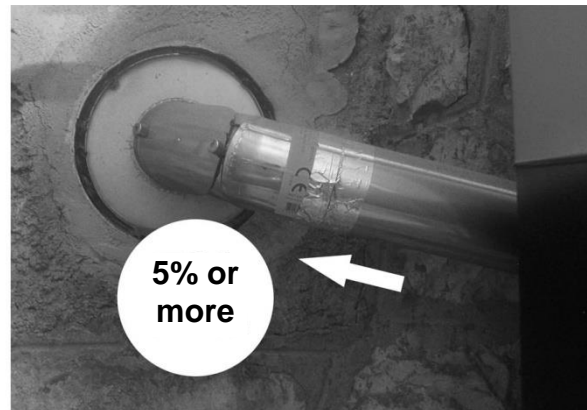

**Figure 5**

### 5.3 INSULATION AND DIAMETER OF HOLES IN THE ROOF

Once the position of boiler installation is determined, a hole for passage of smoke pipes must be made. This changes in regard to the type of installation, diameter of smoke pipes and type of wall or roof, through which it must be guided. Insulation must be of mineral origin (rock wool) with nominal density greater than 80 kg/m<sup>3</sup>.

Perfect draught depends mostly on flue pipe, which must be free of obstructions, such as bottlenecks and/or various joint connections. Joint must be at an angle of 30°, 45° and 90°. Joints at an angle of 90° must be made of three parts (**figure 6**).

In any case, it is mandatory to provide an initial vertical straight pipe of 1,5 metres in length (minimum) to ensure correct extraction of smoke gases.

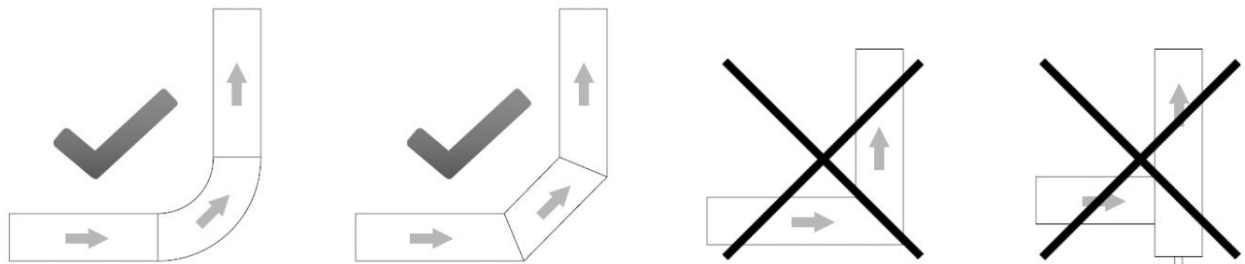

**Figure 6**

### 5.4 AIR INLET

Air from the environment, required for correct combustion, must be refreshed with new air, through opening in the wall, slot in boiler room doors or grid on the window. This will ensure proper combustion and proper boiler operation.

Opening for intake of fresh air must also be fitted with protective slot against rain, wind and insects.

Hole must be made on the external wall of the space, where the pellet boiler is installed.

Standard UNI 10683 prohibits intake of inlet air from storage of flammable materials or spaces with the risk of fire.

If there are other combustion devices in the room, a sufficient amount of air must be ensured, which is required for proper combustion of all combustion devices, and regard all technical properties of already installed ventilation systems in the boiler room.

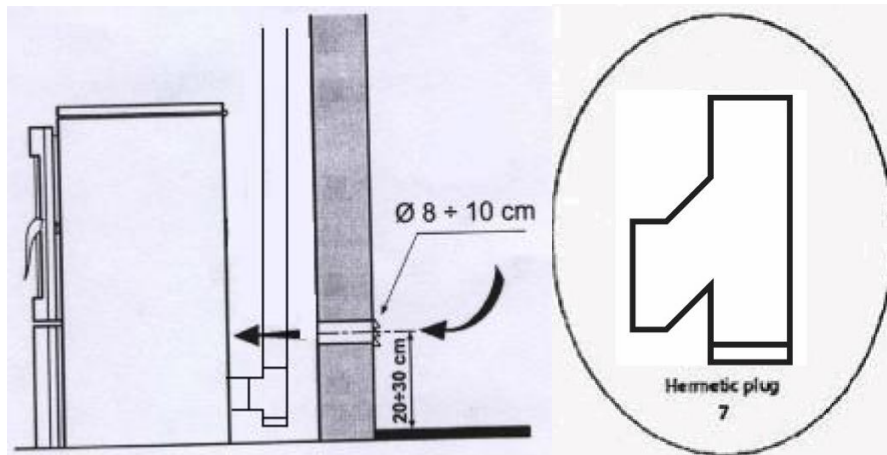

**Figure 7**

## 5.5 ELECTRICAL CONNECTION

Combustion device requires connection to electrical network. Our pellet boilers are fitted with power supply cable for medium temperatures. If the power supply cable is damaged and must be replaced, contact our service staff.

Before making electrical connections, make sure that:

- The characteristics of electrical wiring meet the data, given on the combustion device.
- **Extraction of smoke gases is earthed in accordance with regulations and local requirements in force. (Earthing is required by law).**
- **Power supply cable must never reach 80 °C above ambient temperature.** If you want to connect the boiler directly to electrical network, you must install a bipolar switch with minimum distance of 3 mm between contacts, suitable for required electrical voltage and in accordance with regulations in force. Bipolar switch must always be accessible, even after the boiler is installed.

### ELECTRICAL CONNECTION

The pellet boiler must be connected to electrical network. Power supply cable is 1,5 m long, black with plug. In case of malfunction or improper operation of the boiler, immediately turn off the boiler, switch the switch to position OFF (0) and contact the authorised service center.

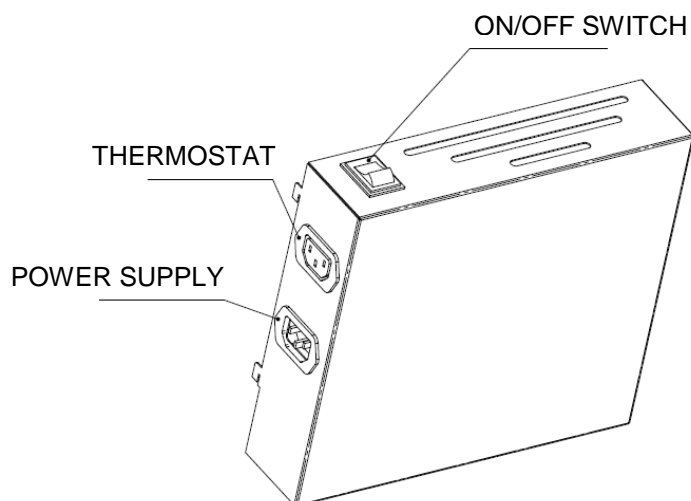

**Figure 8**

If the boiler wont be used for a long period of time, please disconnect the power cord from the power supply or switch the switch to position OFF (0).

## **6 FIRST START UP**

---

**The first start up can only be done by the manufacturers authorised service otherwise the warranty is not valid.**

INSTRUCTIONS FOR THE SAFETY OF PERSONS, ANIMALS AND PERSONAL PROPERTY  
We wish to inform the installer of some of the general guidelines that need to be followed for proper installation of the boiler. These are the required standards, but they are not enough; For more precise information, you need to read the rest of the manual.

- Connect the power supply to the boiler.
- Do not let animals or children close to the boiler.
- Use only good quality of pellets and not any other type of fuel.
- Inform all users of potential risks and hazards and teach them how to operate the boiler.
- If the boiler is placed on a wooden floor, the floor must be protected according to regulations.

# 7 SAFETY WARNINGS

---

## 7.1 SAFETY WARNINGS FOR MAINTENANCE STAFF

Along with adhering to general safety regulations, maintenance staff must also:

- Always use safety devices and individual safety equipment according to Directive 89/391/EEC;
- Disconnect power supply before commencing any work;
- Always use suitable tools;
- Before commencing any work on the boiler, ensure that the boiler, as well as the ashes in it, are cold, especially before touching it;
- **PELLET BOILER IS NOT TO BE CONSIDERED USABLE, IF EVEN ONE SAFETY DEVICE IS MALFUNCTIONING, INCORRECTLY REPAIRED OR NOT FUNCTIONING!**
- Do not perform any modifications of any type for whatever reason other than those allowed and/or approved by the manufacturer or authorized person.
- Always use original spare parts. Do not wait for boiler components to wear out before replacing them. Replacing a worn-out part, before it malfunctions, helps prevent injuries, caused by sudden failure of a component, which can seriously jeopardize persons and/or their property.

When cleaning ash, also clean the combustion container and space beneath it.

## 7.2 SAFETY WARNINGS FOR USER

Space, where the pellet boiler will be placed, or installation area, must be in accordance with local, national and European directives.

The pellet boiler is a combustion device and external surfaces of the boiler can reach higher temperatures during operation.

The pellet boiler is a C1 class boiler, produced exclusively for burning wood pellets (pellets of 6 mm in diameter and 30 mm in length with maximum moisture content up to 10 %) or for fuel C1 (wood pellets) in accordance with standard EN 14961-2.

When using a combustion device, it is advisable to take special care of the following:

- during boiler operation DO NOT approach it and do not touch the doors of combustion chamber, because of DANGER OF BURNS;
- during boiler operation DO NOT approach it and do not touch the flue connection, because of DANGER OF BURNS;
- during boiler operation DO NOT perform any kind of cleaning on the combustion device;
- during boiler operation do not open the doors of the firebox, because it operates properly only when its doors are hermetically sealed (if you open the doors during operation, an alarm will sound);
- during boiler operation DO NOT remove ashes;
- DO NOT allow children and animals to come near the pellet boiler;
- ADHERE TO REQUIREMENTS SET FORTH IN THIS DOCUMENT.

For correct use of the boiler, also heed to the following instructions:

- Use only and exclusively fuel recommended by boiler manufacturer;

- Follow instructions for maintenance;
- Clean the boiler firebox for each pellet container used (3-14 days, when the pellet boiler and ashes in it are cool);
- DO NOT use the pellet boiler in case of operation malfunction or other irregularities, abnormal noises and/or suspicious faults and IMMEDIATELY contact authorized service personnel;
- DO NOT spill water on the boiler, as well as put out fire in the combustion chamber with water;
- DO NOT lean on the boiler, as it may be unstable and could tip over;
- DO NOT use the pellet boiler as support or a fastening item. Do not leave the container cover open;
- DO NOT touch the painted surfaces of the boiler during operation;
- DO NOT use wood or charcoal in the pellet boiler, use only pellets with the following properties:  
 dimension: diameter 6 mm,  
 maximum length: 30 mm,  
 moisture content: up to 10 %,  
 combustion value: minimum 16,9 MJ/kg or 4,7 kWh/kg,  
 ash content: below 0,7 %
- DO NOT use the boiler as an incinerator;
- Always ensure maximum safety.

## 8 INSTRUCTIONS FOR SAFE IGNITION AND CLEANING OF BOILER

---

NEVER use fuel oil, lamp oil or any other oil or any other flammable liquid to ignite the pellet boiler. Store all such liquids far away from the pellet boiler during operation.

Ensure that the pellet boiler is positioned properly and that it does not move.

Ensure that you have closed the firebox properly, and that it is closed during operation of the pellet boiler.

Vacuum ashes only when the pellet boiler is cool.

Do not use abrasive products to clean the pellet boiler.

### 8.1 REGULAR MAINTENANCE AND CLEANING OF BOILER

Use of vacuum cleaner with separator will make cleaning ashes from the boiler easier.

Before starting any kind of maintenance, also cleaning, heed to the following safety precautions:

- Shut off the pellet boiler before performing any kind of work
- Before performing any kind of work on the boiler, make sure that the ashes in the boiler are cool

Vacuum ashes from the combustion at least once every ten days or at each used pellet container (only when the boiler is cool) (*figure 10*).

Vacuum and carefully clean the combustion container at least once every ten days or at each used pellet container (only when the boiler is cool) (**figure 10**).

Once a month, remove the front door at the bottom of the exchanger on the right side of the boiler and vacuum the inside (**figure 10**).

Always make sure that the pellet boiler and ashes in it are cool.

This is the combustion container for burning pellets (**figure 9**). We recommend inspecting and cleaning ashes from the bottom of combustion chamber upon each cleaning. When you place the combustion container back in its place, make sure that it is set correctly: it must be pushed towards the back wall all the way. Only then you can be sure that the boiler will function properly.

2. The opening for the heating element.

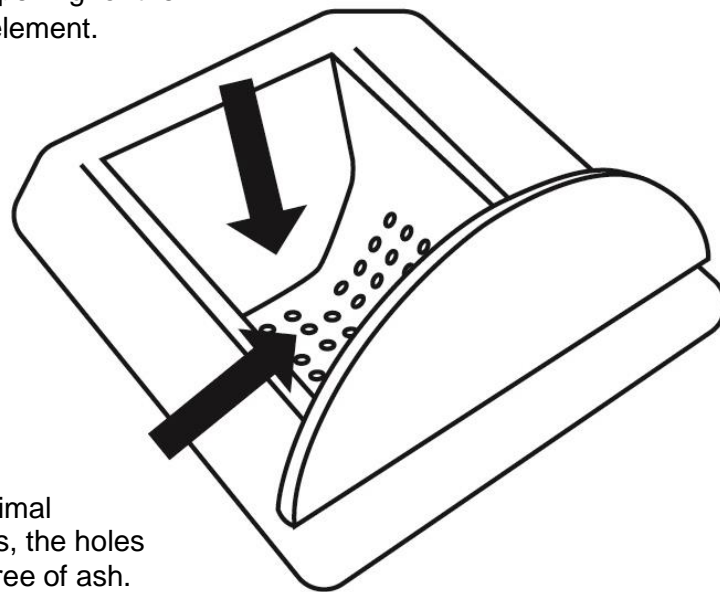

1. For optimal operations, the holes must be free of ash.

**Figure 9**

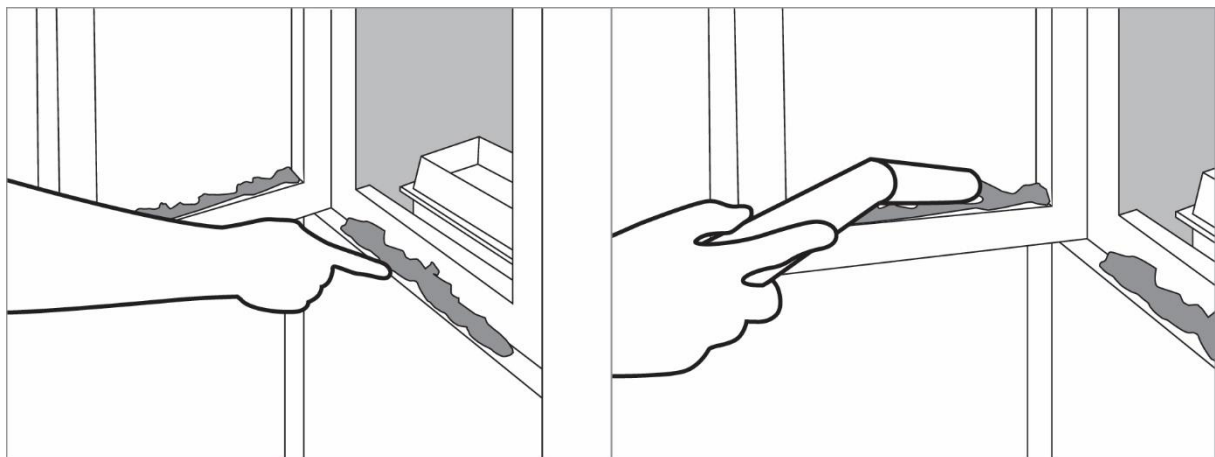

**Figure 10**

If you require any explanation do not hesitate and contact your installer. Because the manufacturer has no control of the installer's work, he cannot guarantee performance of his work and maintenance.

**The manufacturer shall in no way be held responsible for damages caused by third parties.**

The combustion chamber must be cleaned after each used pellet container, vacuumed and/or emptied of all impurities remaining after the pellets have burned.

Never put pellets which have not burned back in the pellet container or ash box.

## **8.2 CONTROL AND PARTS REQUIRED MAINTENANCE**

CHECK THE FOLLOWING ITEM AND MAKE SURE THAT THE PELLETT BOILER IS OPERATING PROPERLY. THIS WILL INCREASE ITS EFFICIENCY AND THE EMITTED HEAT INTO THE SYSTEM WILL ALSO INCREASE:

- For perfect cleaning, vacuum ashes from beneath the combustion container and from combustion chamber every week. Use a broom or a brush to clean firebox walls.
- Clean the fan for extraction of smoke gases by removing fan protection and cleaning fan blades with a broom or a brush.

GENERAL BOILER CLEANING AFTER THE END OF SEASON OR BEFORE THE START OF SEASON:

- At the end of heating season, disconnect the boiler from electrical network. It is very important to clean and inspect the boiler, as described in the instructions.
- Door seal, fitted with high-temperature resistant fitting material, can detach after prolonged use. To reattach it, apply high-temperature fitting material on the back of the seal. This ensures hermetic sealing of firebox doors.

FLUE CONNECTION – CHIMNEY (must be cleaned at the end of each season).

## **8.3 ADDITIONAL MAINTENANCE**

Your pellet boiler is a heat generator which uses pellets. Therefore, it requires a special type of maintenance by authorized personnel of company Gorenje d.d. each year. Regular annual maintenance keeps the combustion device in good condition, ensures greater efficiency, retains warranty and extends life expectancy of the device. Type of work, described in the previous chapter, is advisable to perform after the end of heating season. Their purpose is to check and ensure flawless operation of all components.



## 9 IMPORTANT SAFETY INFORMATION

---

You have purchased a product of the highest quality.

The supplier is at your disposal in transferring required information. Correct installation of combustion device in accordance with instructions is important to prevent any poor functioning, hazard or risk of fire.

Pellet boiler operates on the basis of negative pressure in the combustion chamber. Therefore, always ensure that the flue connection is thermally sealed.

## 10 PELLET QUALITY IS VERY IMPORTANT

---

The pellet boiler is designed for use with pellets. Because the market offer many types and dimensions of pellets, it is very important to obtain pellets free from impurities. Make sure that you use only pellets that are compact and dust-free. Ask your supplier for suitable pellets with 5 mm diameter 30 mm length. Proper operation of the pellet boiler depends on the type and quality of pellets.

Pellets are filled in the pellet container from above through the opening in foldable cover of the container (**figure 11**). Make sure that, during filling, no hard objects foil or other objects that could interfere with the operation of dosing screw, do not enter the pellet container.

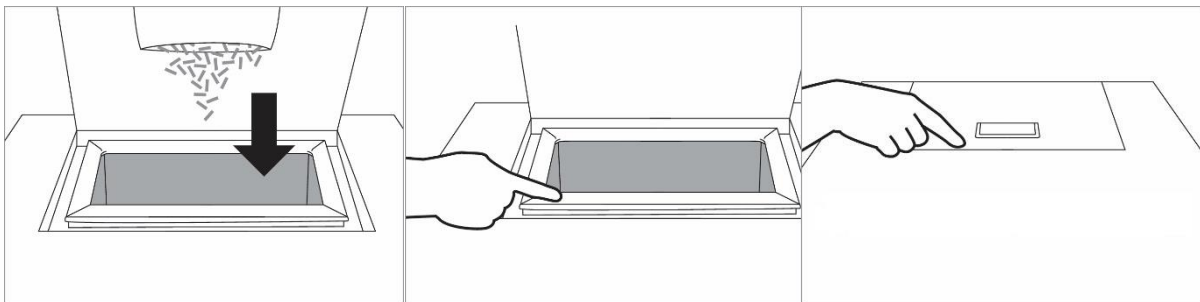

**Figure 11**

### 10.1 STORING PELLETS

Pellets must be stored in a dry and not too cold place.

Cold and damp pellets (temperature about 5 °C) reduce thermal power and require more frequent boiler cleaning.

When handling pellets, be careful not to scatter them.

If you fill the pellet container with sawdust, it can block the pellet dosing system.

# 11 DESCRIPTION AND OPERATION OF CONTROL DEVICE

## 11.1 DESCRIPTION OF KEYBOARD WITH DISPLAY

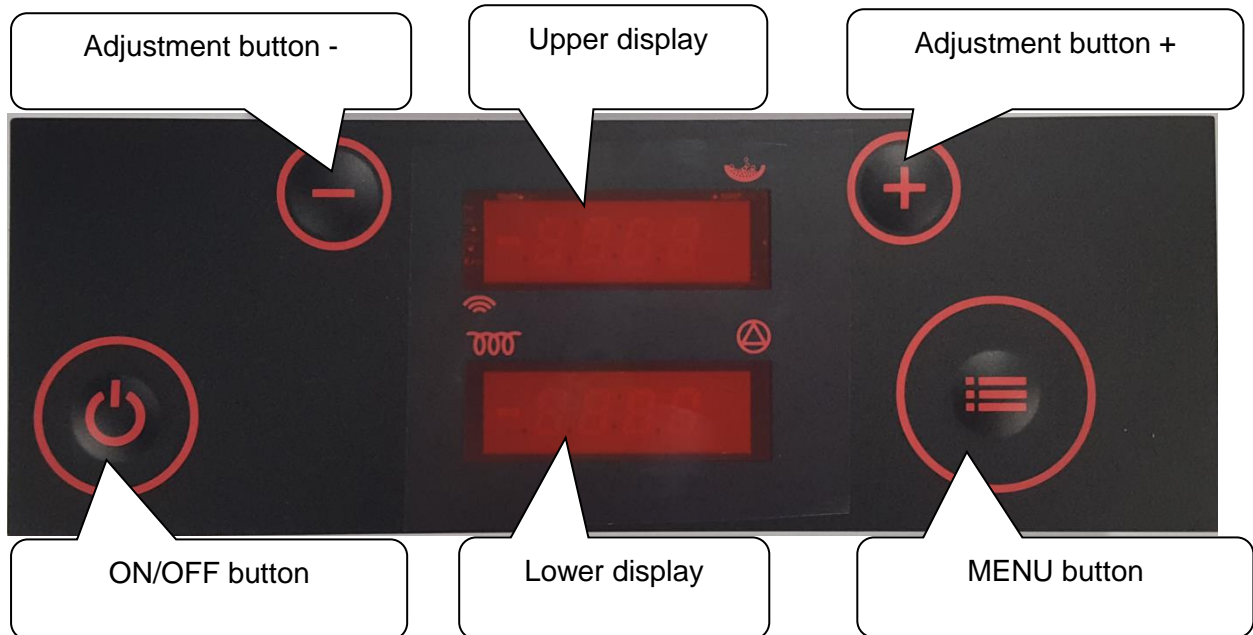

### Display

### Function



**upper display** shows boiler status, chosen menu and indicates dosing operation and operation in time programme



**lower display** shows current time, value of settings and parameters and warning names



spark plug operation indicator



pump operation indicator



dosing operation indicator

## Display during boiler operation in burning phase

Upper display: upper display alternately shows:  
**BURN** and then **P5D5**, where **Px** means actual current operation power and **DX** set operation power

---

Lower display: lower display alternately shows:  
Temperature of smoke gases: **155**  
Temperature of water in the boiler: **B72**  
Temperature of return water: **r45**

---

## Display during boiler stand-by:

Upper display: **OFF**

---

Lower display: Time: **18:35**

---

### Button

### Function



#### ON/OFF button

Press and hold to turn the boiler on/off.  
Short press to return to basic display.

---



#### Button UP

Press during operation to increase set power.  
When pressing MENU button beforehand, this button increases desired water temperature in the boiler. In menu mode, we select desired submenu by pressing.

---



#### Button DOWN

Press during operation to decrease set power.  
When pressing MENU button beforehand, this button decreases desired water temperature in the boiler. In menu mode, we select desired submenu by pressing.

---



### **MENU button**

Short press in basic display shows set value of water temperature in the boiler, which can then be modified with buttons + and -.

Press and hold for at least 2 seconds to activate menu mode.

Press and hold for at least 4 seconds to enter advanced menu settings. Subsequent pressing of the button display menu choices.

---

## **11.2 BOILER DURING OPERATION**

The display shows current operation phase (e.g. TestFire, HeatUp etc.). Upper display shows set and actual boiler power alternately every 5 seconds.

Press **button +** to increase set power value, and press **button -** to decrease it.

Press **MENU button** to display set water temperature in the boiler. You can modify it with **buttons + and -**.

The boiler operates at set power, until water temperature in the boiler reaches modulation threshold or until smoke gases reach limits. In first case, Regu H2O is displayed, and in second Regu Gas.

In case of power outage for less than 2 minutes, the boiler resumes normal operation when power supply restores. If the outage lasts more than 2 minutes, the boiler automatically performs safety shutdown and cooling and then restarts.

## 11.3 BOILER SHUTDOWN

When pressing and holding the **ON/OFF button** for more than half a second (during boiler operation), the display shows **ON**, and the boiler starts shutdown sequence once the button is released. Dosing screw turns off and the display indicates **STOP FIRE**. Fans operate at high speed to prevent excessive increase of water temperature in the boiler. When the boiler cools down under set temperature, fans switch to maximum speed and blow out the last parts from the firebox. Display indicates **OFF**.

## 11.4 BOILER ACTIVATION

When pressing and holding the **ON/OFF button** for more than half a second (boiler at standstill), the display shows **OFF**, and the boiler begins activation sequence once the button is released. Display indicates **TESTFIRE**. Fans operate at high speed to clean the firebox. Dosing screw is at standstill, spark plug is heating.

If the firebox temperature is low, sequence **HEAT UP** begins, where pellets are dosed quickly and fans stand still. Then sequences **Fuel IGNI** and **TEST IGNI** start, until the boiler reaches conditions for transition to burning phase (**BURN**).

With the press on the **MENU** button for 2 seconds (releasing the button when the display displays **tH2O**) we can see the temperature of water in the boiler. With the press on the **UP/DOWN** button we can see the rest of the temperatures and statuses.

## 11.5 TIME PROGRAMME SETTING

Press and hold (until **TEN** displays) **MENU** button to access time programme menu. You can select a setting with a press of the **MENU** button. Adjust the selected setting with the **UP/DOWN** arrows and confirm it with the **MENU** button.

By setting the timer **ON** or **OFF**, the timer activates or deactivates.

Before activation of the timer menu, accurate time and day of the week (1 is Monday etc.) must be set. Then you can programme 6 periods and temperatures.

Each of 6 time period is determined by start (**P1a** – programme 1 start time) and end time (**P1d** – programme 1 end time). In this period, the boiler is active and operates by maintaining water temperature in the boiler (**P1t**).

Then select up to 3 time periods for each day of the week.

Example (Tuesday): upper display shows **DAY2**, and lower **t1P1**, **t2P3** and **t3P6**, which means that the boiler will be active on Tuesday in periods, programmed with programmes **P1**, **P3** and **P6**.

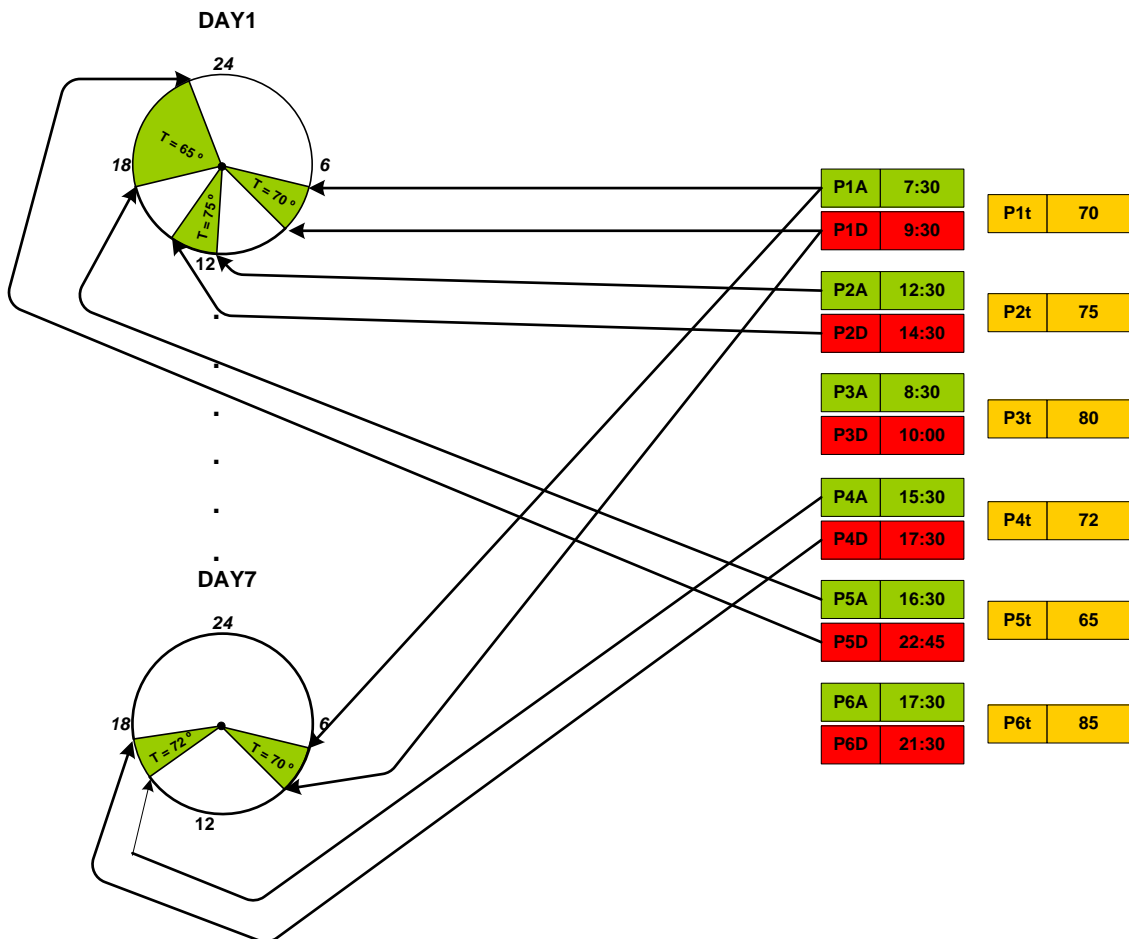

Figure 12

## 11.6 INDICATIONS AND MESSAGES ON DISPLAY

Indication on display	Explanation of message and status of the boiler
OFF	The boiler is in stand-by mode.
12:53	
°OFF	The boiler is in stand-by mode, but the time programme is active and will start automatically, as set with time programme.
12:53	
TEST	The boiler checks if there is a flame in the firebox and for proper combustion this sequence starts after power supply outage.
FIRE	
HEAT	V fazi vžiga, ko je dozirni polž napolnil kurišče, vžigalna svečka segreva pelete do vžiga.
UP	
FUEL	After Heat up phase, the boiler ignites pellets. No dosing in this phase.
IGNI	
TST	At the end of ignition phase, the boiler shuts off the spark plug and tests, if the ignition was successful and if combustion is correct and temperatures rise correctly.
IGNI	
BURN	Burning phase (normal work phase). Lower display shows temperature of smoke gases at exit from the boiler.
123	
BURN	Burning phase. Lower display shows water temperature in the boiler.
B78°	
BURN	Burning phase. Lower display shows temperature of return water.
R48°	
P5D5	Burning phase. Upper display shows current power of the boiler (Px) and set power of the boiler (Dx).
R48	
CLN	Cleaning phase. Fans blow out ash and other residues from the firebox. This phase starts automatically from time to time during burning phase.
FIRE	

FIRE	The boiler is in stopping sequence and is cooling down.
STOP	
COOL	When water temperature in the boiler, even with minimum power, reaches set temperature, the boiler enters phase COOL FLUID and cools down. The boiler restarts automatically when the water in the boiler cools down under set value.
FLUID	
ALAR	Lack of pellets in burning phase.
PELL	
ALAR	Unsuccessful ignition. Check boiler status, clean firebox and try to reignite the boiler.
FIRE	
ALAR	Thermal safety activated. Check boiler status and, if no anomalies are determined, manually reactivate safety and restart the boiler, or contact the service centre.
STB	
ALAR	Safety pressure control activated. Check boiler status and, if no anomalies are determined, restart the boiler, or contact the service centre.
PRES	
ALAR	No signal of smoke gases sensor. Contact the service centre.
TC1	
ALAR	No signal of firebox temperature. Contact the service centre.
TCH	
ALAR	Clean the boiler and/or flue.
DRTY	
ALAR	No signal of water temperature. Contact the service centre.
NTC	
ALAR	Temperature of smoke gases is too high.
GASS	



# 12 MENU

When holding MENU button, menus scroll. To select a certain menu, release the button when it is displayed. Descriptions of individual menus are provided below:

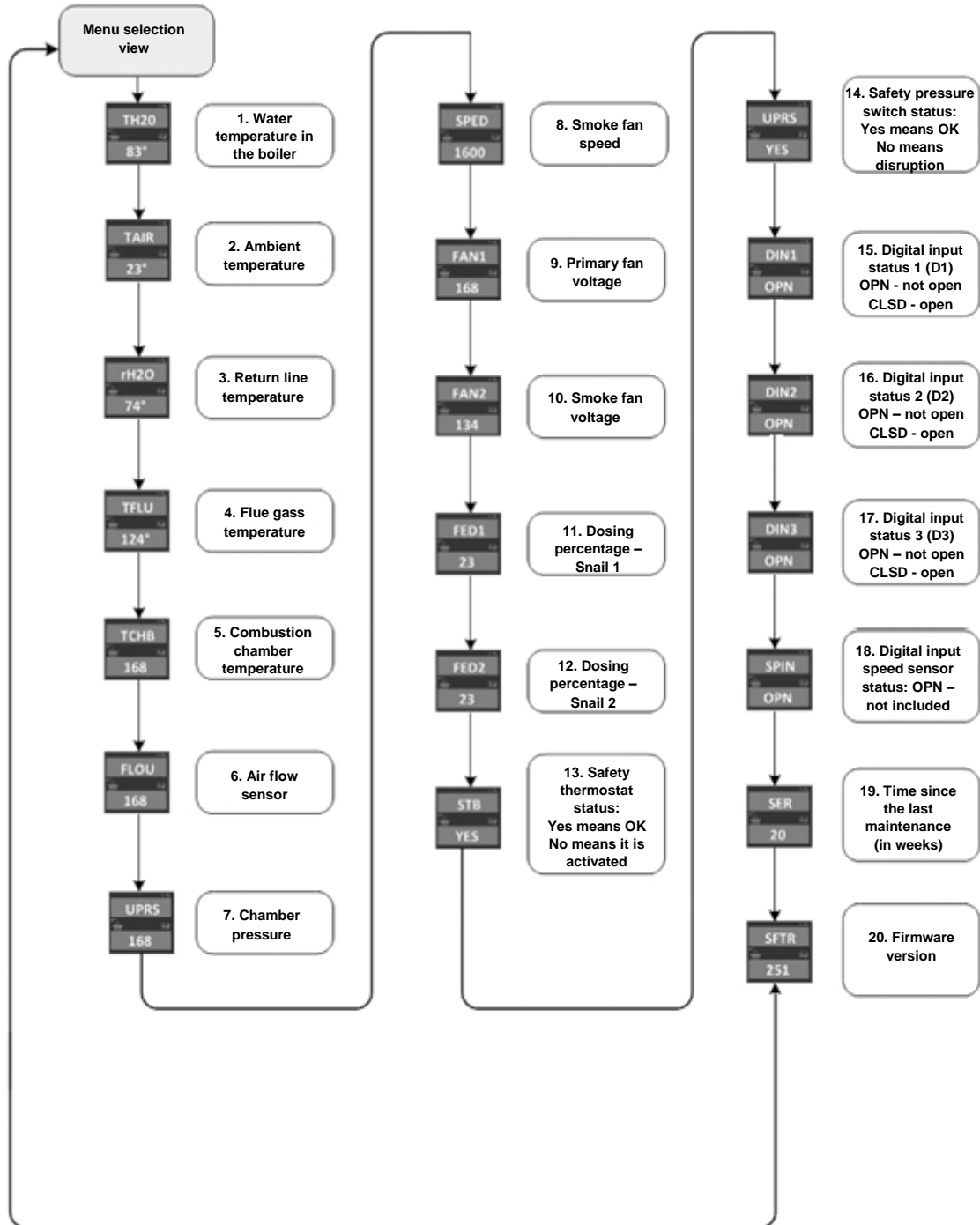
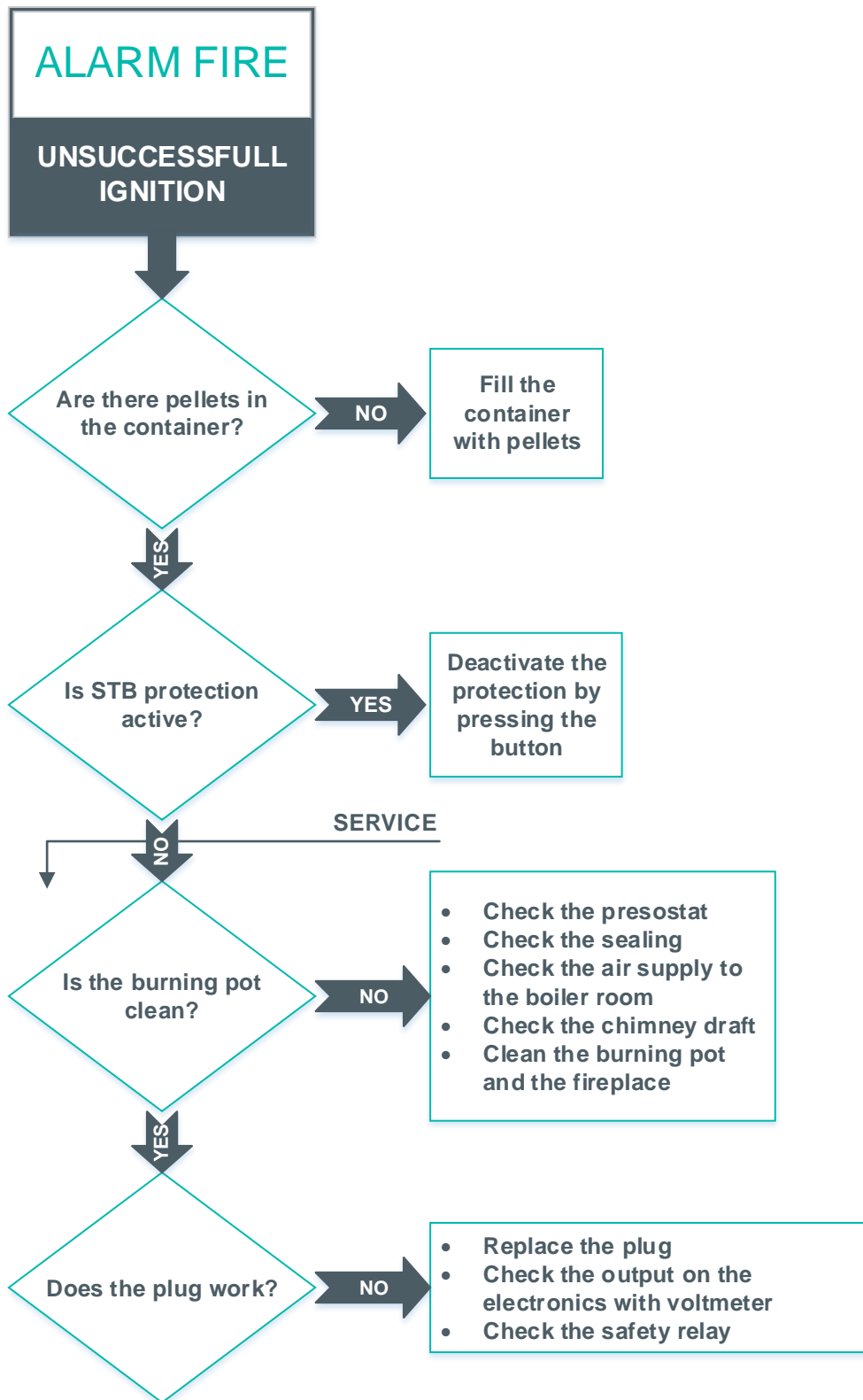
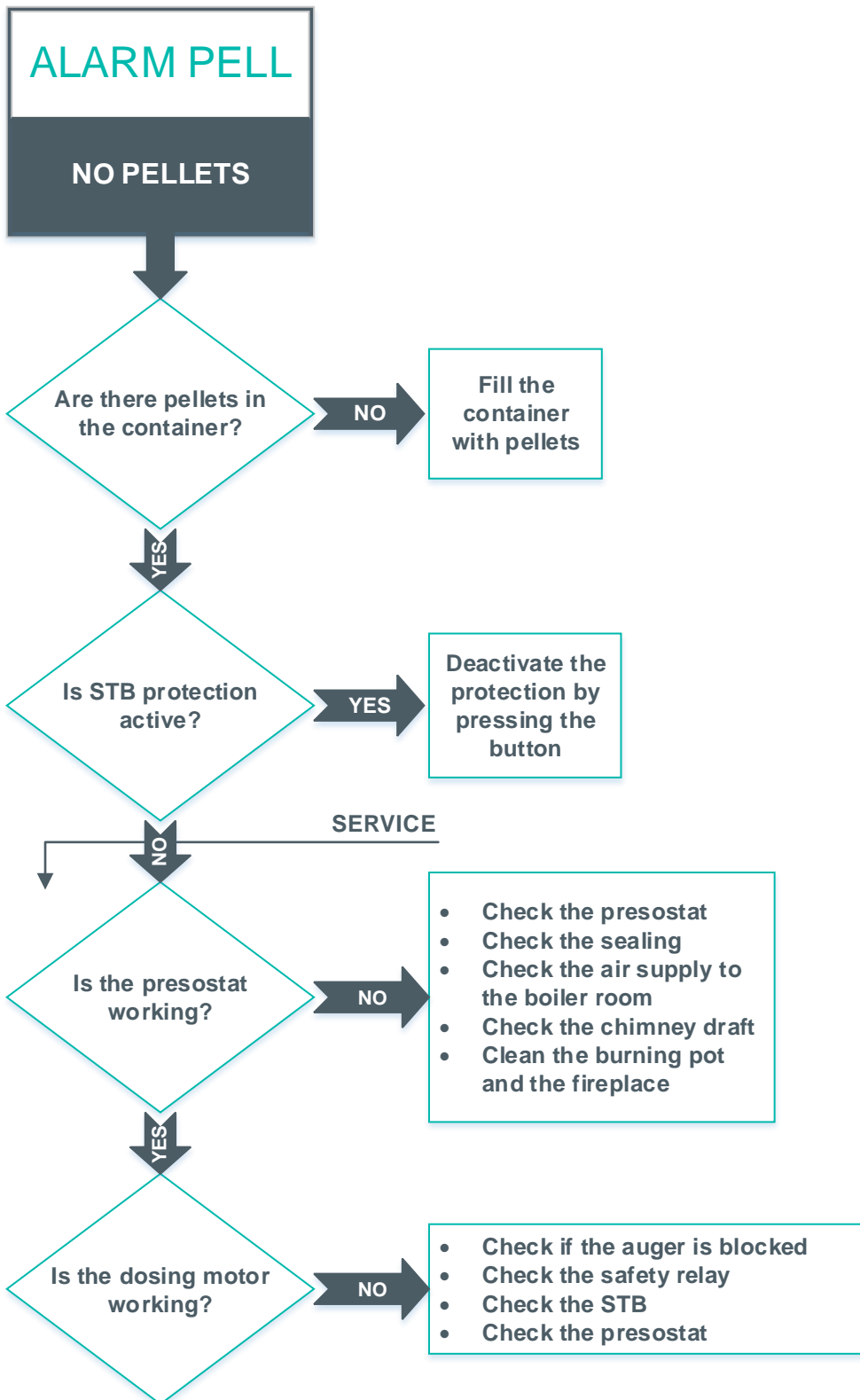
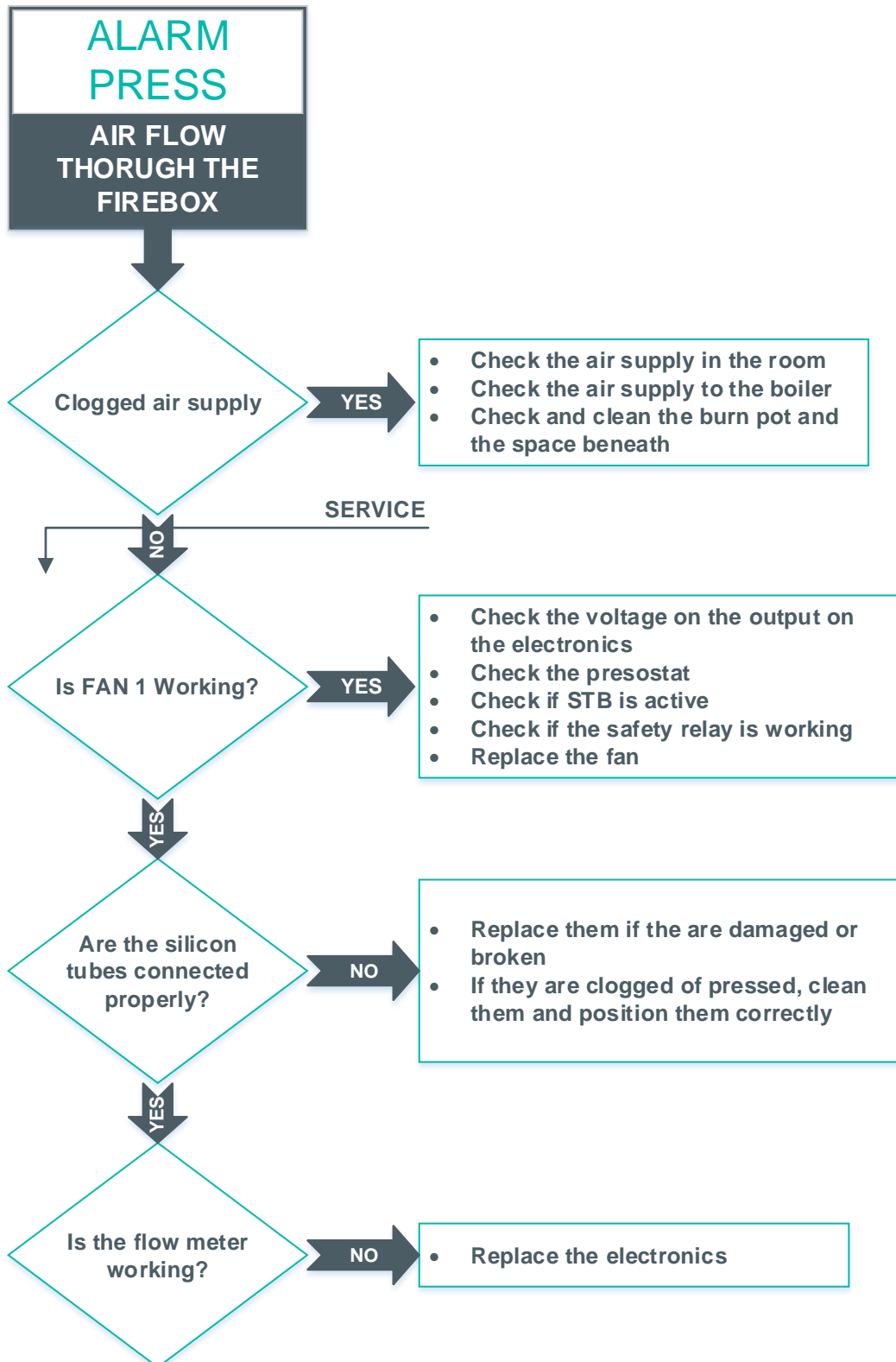

Figure 13: Menu description

# 13 ALARM STATUSES







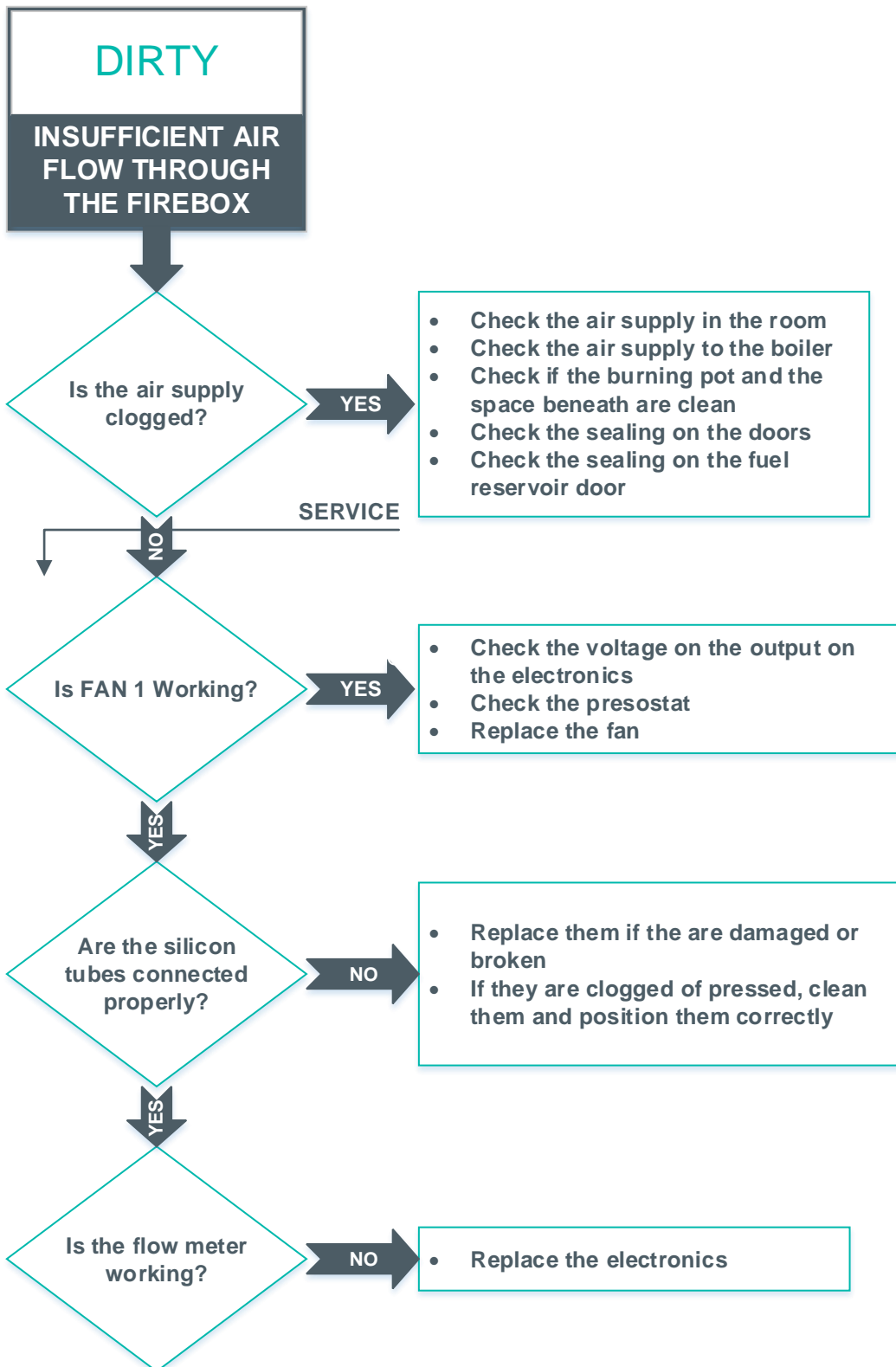

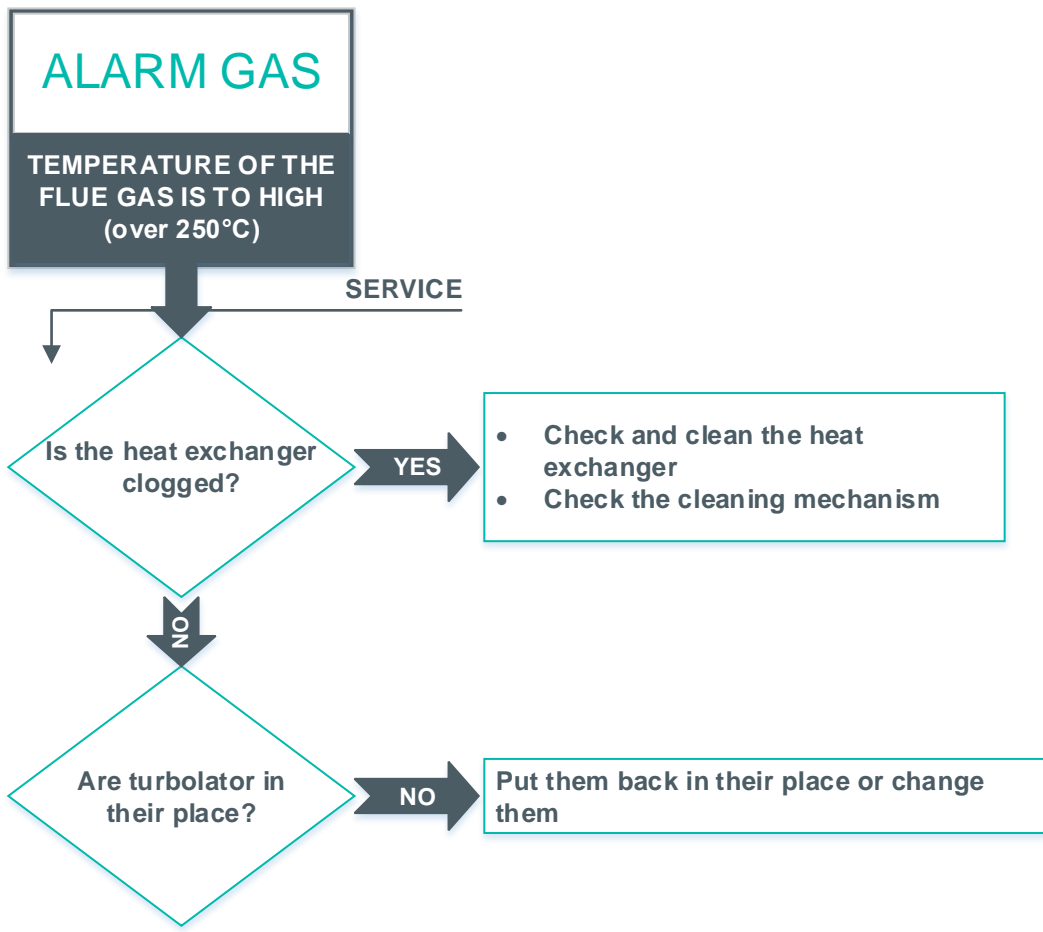
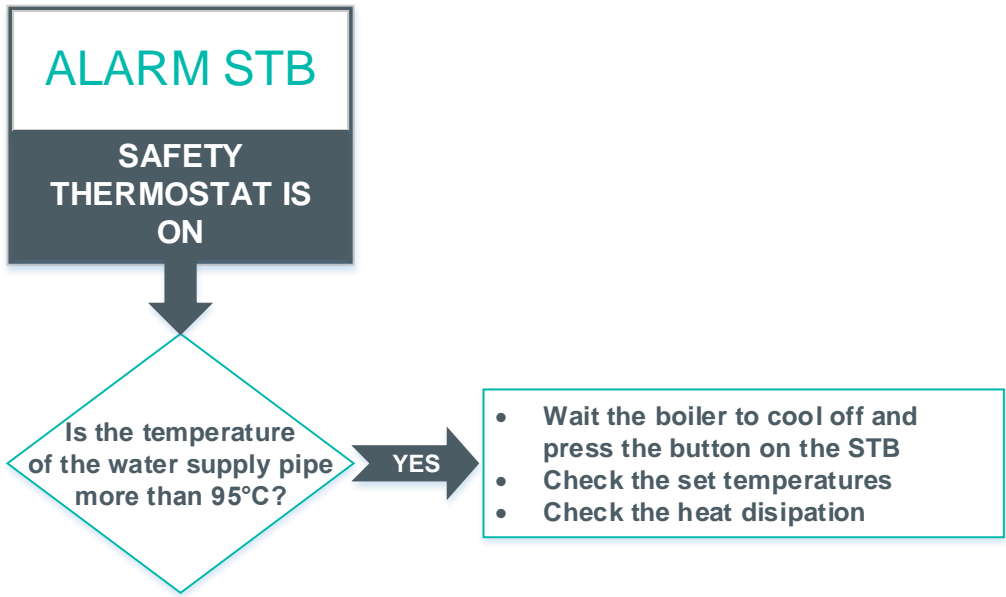

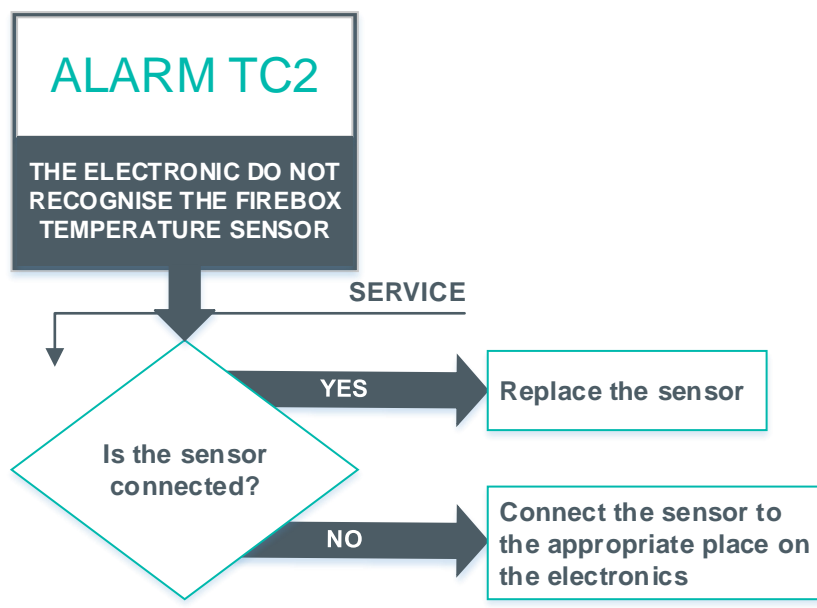
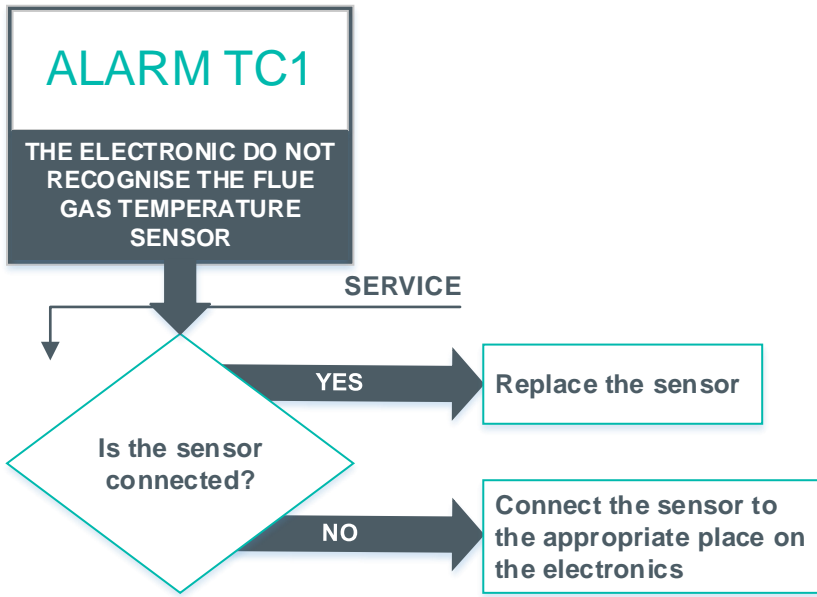

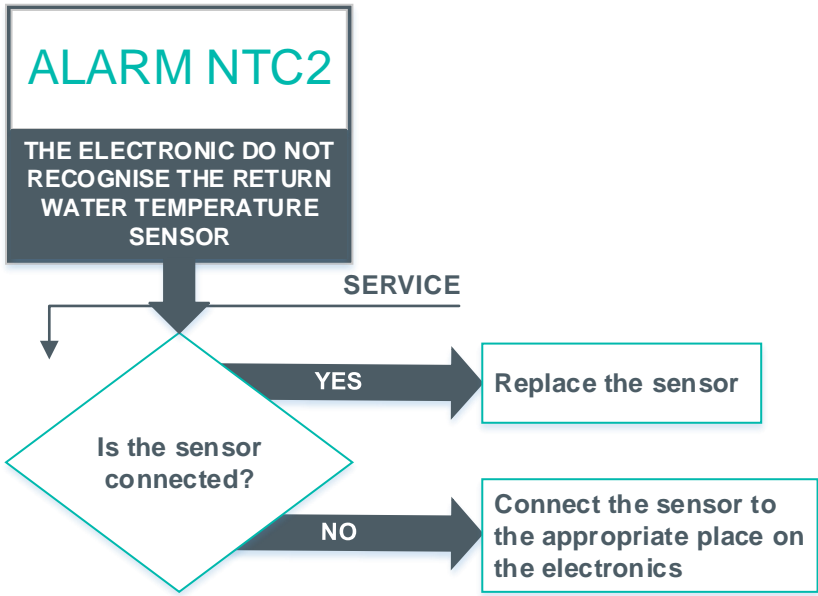
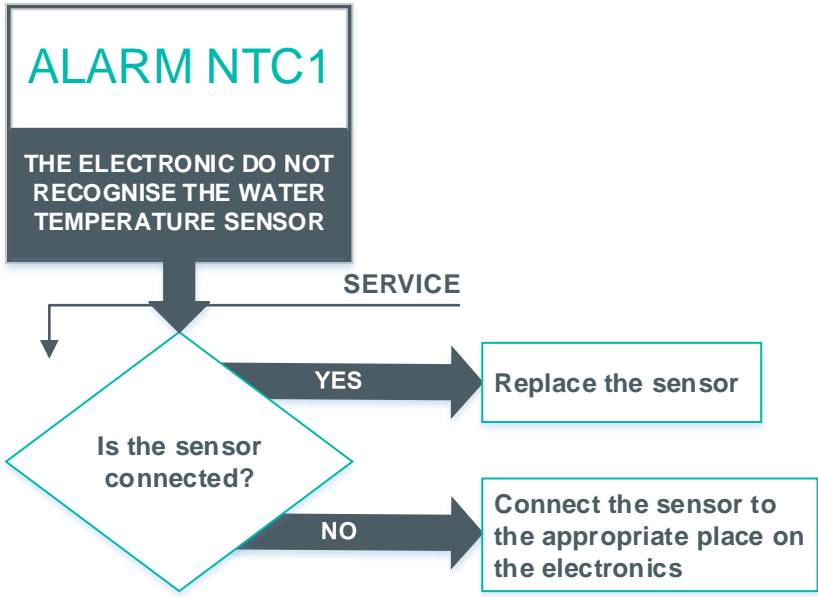



## 14 INFORMATION REGARDING DESTRUCTION AND DISPOSAL OF BOILER

---

Destruction and disposal of pellet boiler is sole responsibility of the owner, who must act in accordance with laws in force in his country regarding safety, respect and protection of environment.

Destruction and disposal of pellet boiler can be entrusted to a third person with licence or authorization for disposal and destruction of aforementioned materials.

**INDICATION:** in any case, you must adhere to and respect laws in force in the county in which the pellet boiler is installed.

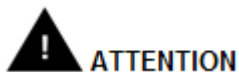

All disassembled parts must be properly disposed of:

- remove all electrical parts;
- disconnect the battery from control device;
- dispose of the battery of control device in accordance with norms in appropriate containers;
- dispose of the boiler core or sell it as scrap metal.

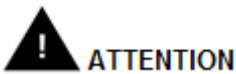

Disposed pellet boiler in accessible areas can present a serious danger for people and animals. Owner of the boiler is always responsible for damage caused.

---

*Once the boiler is destructed, CE mark, Instructions for use, maintenance and installation and other documents regarding the boiler must also be destroyed.*

# 15 TRAJANJE GARANCIJSKE DOBE

---

By this we mean the time period in which we provide service, accessories and spare parts. The warranty period starts from the date of first start-up. The warranty period is in accordance with legal regulations. In case of renewal of the design of the device, the user may order an older version of the part within the statutory deadline. After this period, the modified parts will only be available in the revised version.

## 15.1 WARRANTY CONDITIONS

### OVERVIEW:

For the warranty to be completely valid, as set forth in Directive EEC 1999/44/E (42/2002), the user must carefully heed to instructions in this document, namely:

- Use the pellet boiler in its limits, in accordance with the conditions set forth in the instructions for use;
- Maintain the pellet boiler in a diligent and constant manner;
- Regard all safety precautions in accordance with laws in force;
- Avoid any unprofessional tampering with the boiler;
- Use only original spare parts.

### WARRANTY TIME CONDITIONS:

Warranty for all Gorenje products is valid for 24 months from the date of first start-up, given that a regular maintenance inspection is performed no later than 24 months from the date of start-up.

### GENERAL WARRANTY CONDITIONS:

#### 1. We declare:

- that the product will function flawlessly in the warranty period, if used in accordance with the purpose of use, and if enclosed Instructions for use and maintenance will be adhered to;
- that, in the warranty period, company Gorenje will, through authorized service companies, resolve all faults/defects, due to which the device is not working in accordance with purpose, no later than 45 days from written report of fault or defect;
- that a product, not repaired in the aforementioned deadline, will be, at the request of warranty holder, replaced with a new one, and the warranty period will extend for the time of the repair;
- that authorized service company guarantees warranty conditions with signature and stamp on published warranty.

#### 2. Calling on the warranty:

Warranty is valid under the condition that:

- The customer possesses a valid document (receipt), issued by salesman.
- The combustion device was installed by a qualified and/or trained person, who determines if the device meets all technical characteristics of the system where the device will be installed to, and must be necessarily in accordance with requirements set forth in the instructions.
- The pellet boiler is used in accordance with the instructions for use.

Warranty is called on at the salesman, where you have purchased the device.

Upon claiming fault, provide an accurate description of fault – defect.

#### 3. Period of guaranteeing service and spare parts:

- warranty period, in which we guarantee service and spare parts for undisturbed use of the product, is 7 years from the day of first start-up;
- in case of replacing production models, we guarantee spare parts for your product for 3 years;
- after 7 years, spare parts will be available, but they may be available in different colour than your product.

4. Warranty is void or does not cover damages, caused by:

- Weather, chemical or electrochemical influences, lightning strikes, elementary accidents and/or natural disasters, incorrect use of the product, insufficient maintenance, modifications to the product or tampering with the product, unsuitable or inefficient flue and other reasons not connected to the product, such as incorrect or unsuitable installation;
- Burning of materials, which do not correspond with the type of material given in these instructions;
- Any kind of damage caused by/during transport. Therefore, carefully inspect delivered goods upon reception. If it is damaged, immediately inform the salesman, and record the damage on admission document or supply order;
- If the start-up was performed by a company without appropriate authorization for Gorenje products;
- If the product has been tampered with or repaired by an unauthorized person;
- If the user does not comply with the instructions for use and maintenance;
- If defects or faults arise on the heating device due to defects on equipment of other manufacturers.

Liability of company Gorenje d.d. is limited to unit supply. Unit must be installed properly in accordance with manufacturer instructions, as well as with laws in force. Installation must be performed by qualified personnel, defined by the manufacturer or representative/salesman<sup>1</sup> (and/or under his supervision and liability), who assumes full responsibility for final installation and subsequent correct operation of installed product. In case of non-fulfilment of conditions, company Gorenje d.d. is not liable in any case.

<sup>1</sup> As representative/salesman is considered any natural person or legal entity authorized for sales of products to end users of this warranty.

**NOTE:** Gorenje d.d. shall not be held liable for any damage and consequences, even if these are a consequence of replacement of malfunctioning part of the boiler.

Gorenje d.d. guarantees that all of its products are made of materials of highest quality and with manufacturing processes, which ensure perfect efficiency. If during normal use, there should be any defective or malfunctioning parts, they must be replaced.

**PARTS, SUBJECT TO NORMAL WEAR, NOT COVERED BY WARRANTY:**

- Seals and cast iron parts, which do not show any signs of faults, which could be attributed to manufacturing error;
- Changes in colour, cracks and small dimensional modifications are not substantiated and do not present grounds for rejection, as they are a consequence of natural characteristics of materials.

**LIABILITY:**

Gorenje d.d. shall not recognize any compensation for direct or indirect damage caused by or related to the product.

**SERVICE DURING WARRANTY PERIOD:**

**Gorenje d.d. handles problems regarding warranty only through its authorized persons.**

*Gorenje d.d. is not liable for any mistakes in the instructions. We reserve the right to changes without any prior notice.*

# 16 INSTRUCTIONS FOR FIRST START-UP

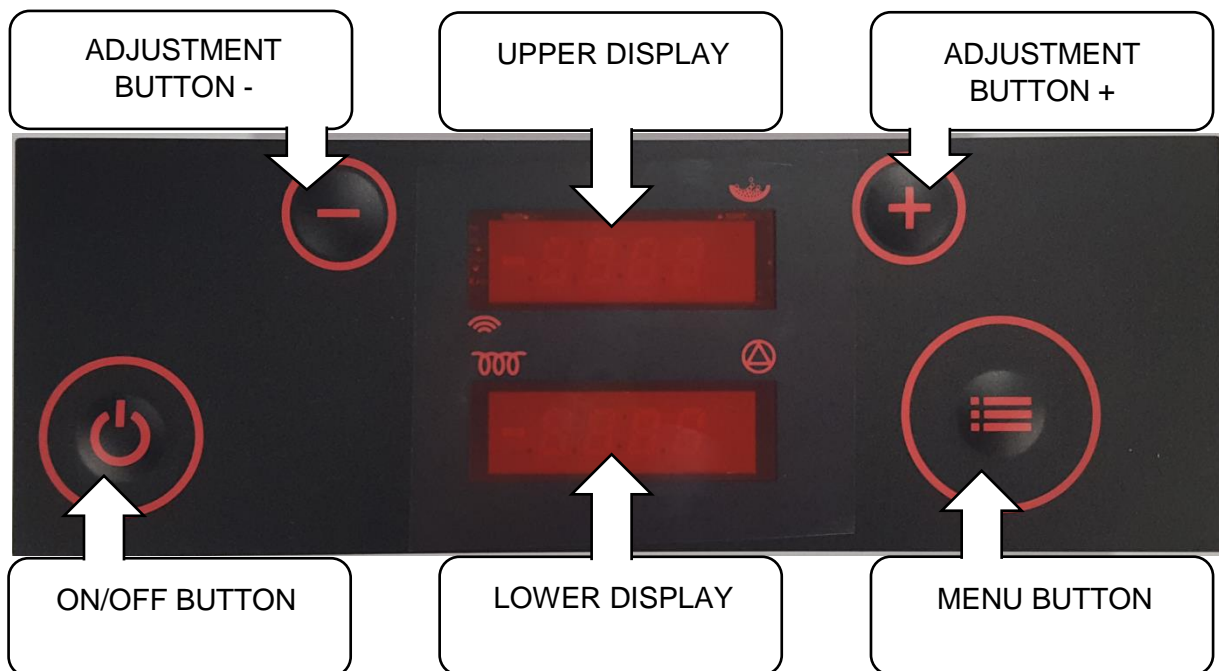





Figure 14: overview of the keyboard

Button	Function
	<p><b>ON/OFF button</b> Press and hold to turn the boiler on/off. Short press to return to basic display.</p>
	<p><b>Button UP</b> Press during operation to increase set power. When pressing MENU button beforehand, this button increases desired water temperature in the boiler. In menu mode, we select desired submenu by pressing.</p>
	<p><b>Button DOWN</b> Press during operation to decrease set power. When pressing MENU button beforehand, this button decreases desired water temperature in the boiler. In menu mode, we select desired submenu by pressing.</p>

---

### MENU button

Short press in basic display shows set value of water temperature in the boiler, which can then be modified with buttons + and -.

Press and hold for at least 2 seconds to activate menu mode. Press and hold for at least 4 seconds to enter advanced menu settings. Subsequent pressing of the button display menu choices.



Use buttons + and - to select parameters in submenus. Short press MENU button and set value of parameter starts flashing, which can then be modified with buttons + and -.

Short press ON/OFF button and hold MENU button to scroll all menu choices and return to basic display.

---

When the installer finishes hydraulic connection to the central heating, flue gas connection to the chimney and the electrical connection to the power supply, the boiler is ready for heating. After reading the manual, the device can be started by pressing the **ON/OFF** button by the installer or qualified personnel.

Please observe the sequence of events on the display:

Upon first start-up, the installer must be careful of correct order of events (displays):

- Press and hold ON/OFF button for 3 seconds. Display indicates ON, and immediately after
- **"Test fire"** – lasts 10 seconds, then goes to:
- **"Heat up"** – quick filling of combustion container with pellets, alternately displaying *P0 d5* (in upper display) and changing temperatures; b – temperature of heating water in the boiler, only number – temperature of smoke gases and r – temperature of return line (in lower display), then goes to:
- **"Fuel igni"** – ignition of combustion device (upon first ignition, ignition phase can last longer, even up to 10 minutes) lasting approximately 5 minutes, alternately displaying *P0 d5* in upper display and temperature in lower display, then goes to:
- **"Igني test"** – checking ignition, display also changes between *igni test* and *P0 d5*, and temperatures in the lower display. When checking is done, it goes to:
- **"Burn"** – boiler operation, upper display indicates Burn, lower display indicates changing b-temperature of heating water in the boiler, smoke gases and r-temperature of water in the boiler:
- LED in upper display above right signals operation of reducer for dosing pellets (when the LED is turned on, the reducer is dosing pellets into the burner and vice versa: if the light is turned off, the reducer is not operating).
- LED in the lower display below right signals when the boiler is supplying pump with voltage – when the pump is operating (when the light is turned on, the pump is supplied with power, which means that the pump is operating and vice versa: if the LED is turned off, the pump is not operating),

- When the temperature of heating water begins to get closer to set temperature, combustion device starts modulation or regulation/reduction of power. In this state, display indicates "**regu H2O**", and upper display alternately shows power (P is the level of boiler operation, d is the level of boiler setting), and lower display shows temperatures.
- "**Cool flui**" – state of shutting down, indicated on the display when combustion device reaches set temperature of heating water in the boiler with addition for regulation (if the temperature of heating water is set to 70 °C, the boiler enters "cool flui" state at 75 °C). When the boiler finishes "Cool flui" state, it means that the heating water in the boiler cooled down. It goes to:
- "**Test fire**" – and the ignition procedure is repeated.

Control of information on operation of combustion device requires menu access into programme of information (shown data is only illustrative). Enter the menu with long press on MENU button (see **figure 22, page 58**), when the display shows "tH2O", release the button. Use + and - buttons to select desired information.

Displayed information is:

- **tH2O** Temperature of heating medium in the boiler
- **rH2O** Temperature of heating medium on return,
- **tFLU** Temperature of smoke gases ((H<sub>2</sub>O) + 30-90 °C),
- **tChb** Temperature of fire in the combustion chamber (615 °C +/- 40 °C),
- **floU** Intake of fresh air into combustion device (480 °C +/- 40 °C),
- **FanI** Voltage on FAN 1 (130 V +/- 15 V),
- **FedI** Percentage of pellet dosing into the burner (70 % +/- 20 %)

Once you have completed viewing information, use + and - buttons to find information "tH2O". When finding it, short press ON/OFF button to return to previous state.

If the display indicates "alarm", cause of the alarm must be determined with alarm list.

WE RESERVE THE RIGHT TO MAKE CHANGES  
THAT DO NOT IMPAIR THE FUNCTIONALITY OF THE DEVICE.

The user manual can also be found at our website <http://www.gorenje.com>.



## **Izjava o lastnostih (DoP)**

Št.: 16-103

**1. Enotna klasifikacijska oznaka tipa proizvoda:**

**AQUA ECOLOGIC 15C, peč na pelete z vodnim toplotnim izmenjevalnikom  
EN 14785:2006**

**2. Identifikacijska oznaka tipa proizvoda:**

**TOPLOVODNA KAMINSKA PEČ AQUA ECOLOGIC 15C**

**3. Predvidena uporaba:**

**KURILNA NAPRAVA ZA CENTRALNO OGREVANJE NA LESNO BIOMASO**

**4. Proizvajalec:**

**Gorenje, d.d.,  
Partizanska cesta 12, 3320 Velenje  
Slovenija**

**5. Ime in naslov pooblaščenega zastopnika**

**Uroš Sablatnik  
Ogrevalni sistemi  
Direktor NES  
Partizanska cesta 12, 3320 Velenje  
Slovenija**

**6. Sistem za ocenjevanje in preverjanje obstojnosti lastnosti:**

Sistem 3

**7. Priglašen organ po harmoniziranem standardu EN 14785:2006**

Kiwa Cermet Italia S.p.A., Via Cadriano, 23-40057 Granarolo dell'Emilia (BO), Italia po izdanem test reportu št: 2001277/C-222 / 07.07.2016 za prvotno tipsko preizkušanje in skladnost zmogljivosti.



# gorenje

## 8. Bistvene značilnosti:

<b>Harmonizirana tehnična specifikacija</b>	<b>EN 14785:2006</b>
<b>Bistvene značilnosti</b>	<b>Zmogljivost</b>
<b>Požarna varnost</b>	
Reakcije na ogenj	<b>A1</b>
Razgalja do gorljivih materialov	<b>Minimalne razdalje v mm</b> Zadaj = 300 Ob straneh = 500 Spredaj = 1000 Spodaj = 30
Tveganje da goreče gorivo pade iz kamina	<b>Opravil</b>
<b>Emisije</b>	<b>CO (0,0056 %) pri nominalni termični moči</b> <b>CO (0,0136 %) pri minimalni termični moči</b>
<b>Temperatura površine</b>	Opravil
<b>Električna varnost</b>	Opravil
<b>Zmožnost čiščenja</b>	Opravil
<b>Maksimalni delovni tlak</b>	2,5 bar
<b>Temperatura dimnih plinov ob nominalni moči</b>	T = 117,1°C
<b>Mehanična odpornost (na nosilnost dimnih cevi)</b>	NPD
<b>Termična moč</b>	
Nominalna termična moč	17,13 kW
Minimalna termična moč	4,97 kW
<b>Energetska učinkovitost</b>	D (93,83%) pri nominalni moči D (90,60%) pri minimalni moči

8. Lastnosti proizvoda, navedenega v točki 1 in 2, so v skladu z navedenimi lastnostmi iz točke. Za izdajo te izjave je v skladu z Uredbo (EU) št. 305/211 odgovoren izključno proizvajalec, naveden zgoraj.

Podpisal za in v imenu proizvajalca Gorenje, d.d.:

**Uroš Sablatnik**  
Direktor NES

Velenje, 15.03.2017

# Emisije snovi v zrak

Gorenje d.d.

Aqua Ecologic 15C

Mala kurilna  
naprava

## Manjše emisije snovi v zrak

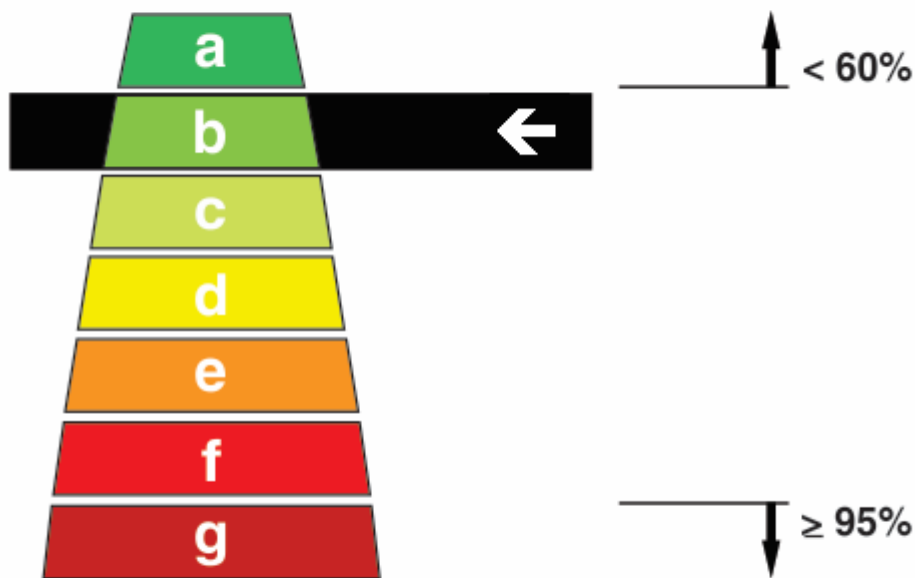

## Večje emisije snovi v zrak

Emisije snovi v zrak so prikazane za kurilne naprave za:

- trdno gorivo z odstotkom emisije koncentracije celotnega prahu glede na njegovo mejno vrednost;
- tekoče ali plinasto gorivo z odstotkom skupnih emisij CO in NO<sub>2</sub> glede na njuni skupni mejni vrednosti.

Uredba o emisiji snovi v zrak iz malih in srednjih kurilnih naprav, Uradni list RS, št. 24/13, 2/15 in 50/16