



INSTRUCTIONS FOR USE  
AND INSTALATION

NAVODILA ZA UPORABO  
IN NAMESTITEV

EN

SL

SMART AIR 360L

**gorenje**



# INSTRUCTIONS FOR USE AND INSTALATION

# WARNINGS

---

- ⚠ The appliance may be used by children older than 8 years old, elderly persons and persons with physical, sensory or mental disabilities or lacking experience and knowledge, if they are under supervision or taught about safe use of the appliance and if they are aware of the potential dangers.
- ⚠ Children should not play with the appliance.
- ⚠ Children must not clean or perform maintenance on the appliance without supervision.
- ⚠ Installation should be carried out in accordance with the valid regulations and according to the instructions of the manufacturer.
- ⚠ If the supply cord is damaged, it must be replaced by the manufacturer, its service agent or similarly qualified persons in order to avoid a hazard.
- ⚠ Some parts of this product can become very hot and cause burns. Particular attention has to be given where children and vulnerable people are present.
- ⚠ Do not cover the device, it may cause serious damage of the device or even start a fire!
- ⚠ To disconnect heater, set controls to OFF, then remove plug from outlet.

**Dear buyer, thank you for purchasing our product.**

PRIOR TO THE INSTALLATION AND FIRST USE OF THE TOWER FAN, PLEASE READ THESE INSTRUCTIONS CAREFULLY.

This tower fan has been manufactured in compliance with the relevant standards and tested by the relevant authorities as indicated by the Safety Certificate. Its technical characteristics are indicated on the label.

## PRODUCT FEATURES

---

- Touch control panel
- LED display
- Timer: 1H,2H,4H,8H
- Infrared remote control.
- (optional) Body sensor, detect person position, select the oscillation angle automatically;
- Automatic 360°horizontal oscillation and 90° vertical oscillation;
- 60°/90°/180°/360°horizontal oscillation angle,
- 3 wind speed: low, med, high;
- wind modes: Normal, Natural, sleeping , ECO
- Sound alerts

# PRODUCT STRUCTURE DIAGRAM

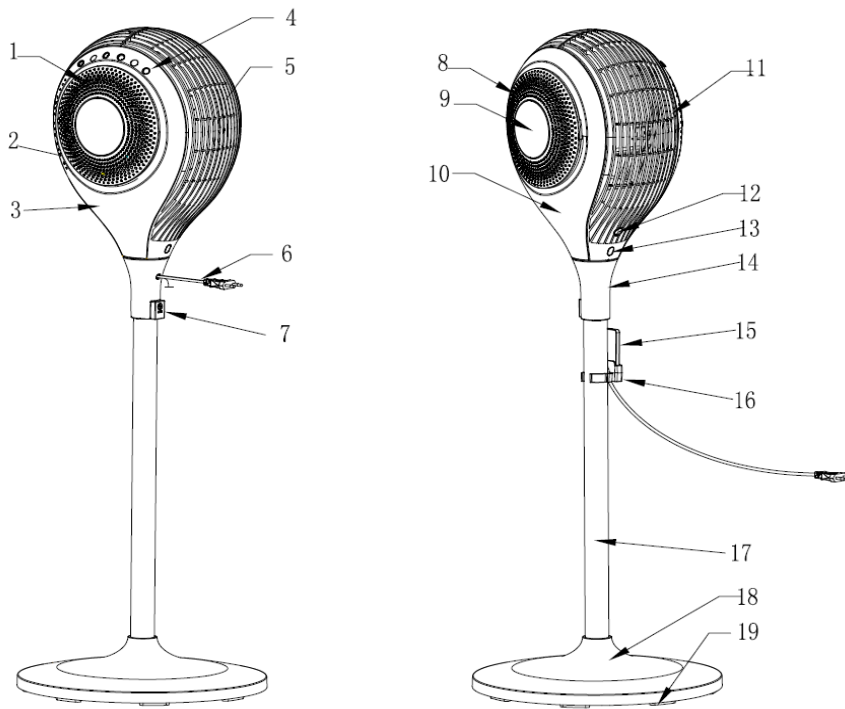

1. Right Wind Inlet
2. LED Indicator Light
3. Right Side Panel
4. Touch Control Panel
5. Back Housing
6. Power Cord
7. Nut Support
8. Left Wind Inlet
9. Decoration Cover
10. Left Side Panel
11. Front Housing
12. Body Sensor
13. Remote Control Receiver
14. Oscillation Base
15. Remote Control
16. Remote Control Holder
17. Column
18. Base
19. Weight Balance of Base

# CONTROL BUTTONS & DISPLAY PANEL

- Control buttons

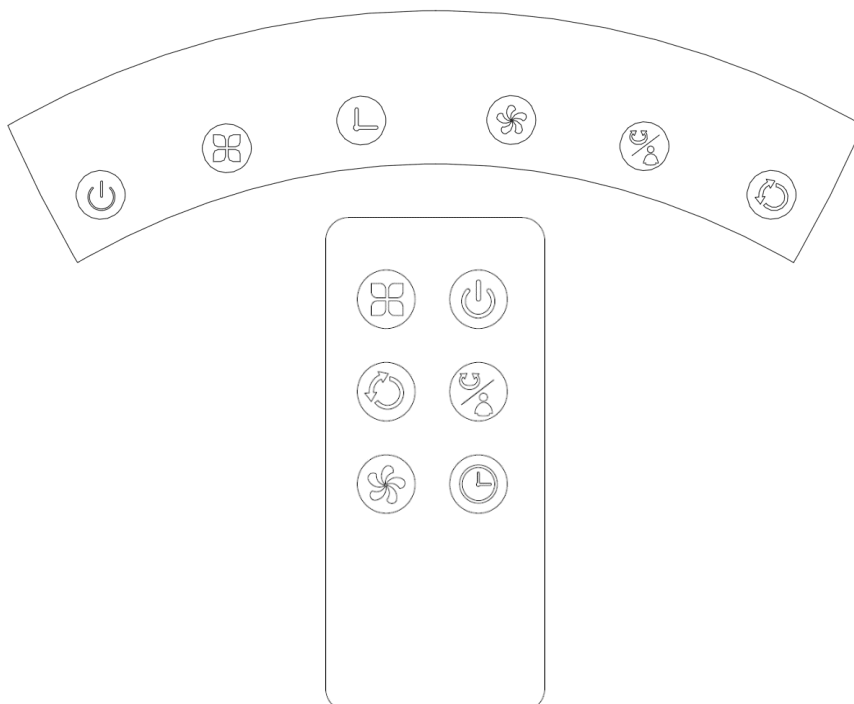

- **Display panel**

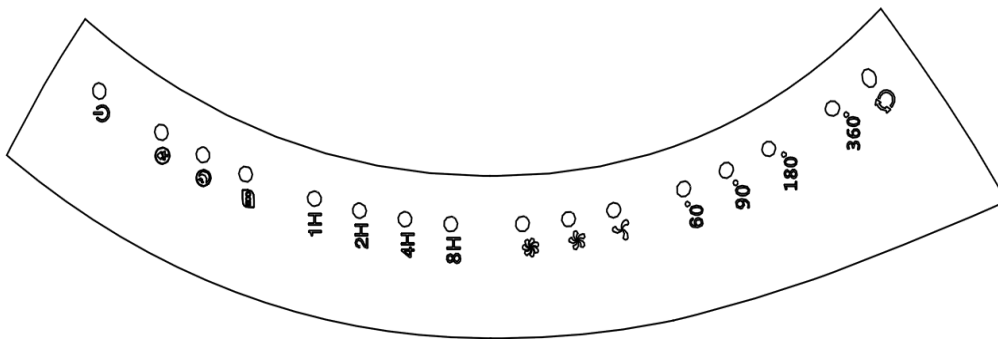

**ON/OFF** button; By pressing this button, you turn on or turn off the device.



**MODE** button; Press this button to change mode (Normal-Natural-Sleep-ECO).



**TIMER** button; Press this button to set the timer function (1h-2h-4h-8h).



**FAN SPEED** button; Press this button to change fan speed (LOW-MED-HIGH).



**HORIZONTAL OSCILLATION/ BODY SENSOR** button; Press this button to set horizontal oscillation angles (0°, 60°, 90°, 180°, 360°). Press this button to activate BODY SENSOR function (some models).



**VERTICAL OSCILLATION** button; Press this button to activate vertical oscillation.

# PRODUCT INSTALLATION

---

1. Take out parts for assembling.
2. Stick the column into the hole on the base and fix them tightly by screw. (Picture 1)
3. Assemble the fan body onto the column tube. (Picture 2)
4. Fix the fan body and the column by screw. (Picture 3)
5. Put the fan on the ground and power it on. (Picture 4)

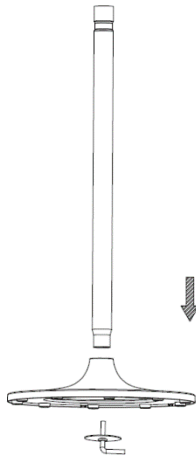

Picture 1

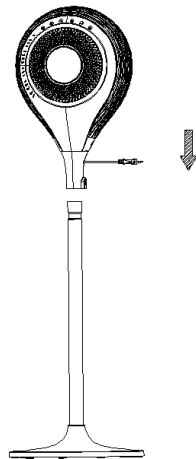

Picture 2

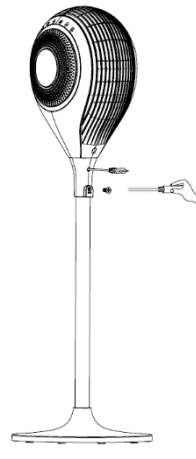

Picture 3

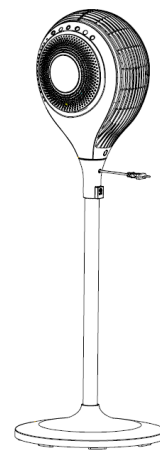

Picture 4

# OPERATING INSTRUCTIONS

---

The buttons are touchable and all the functions can be operated by touching the corresponding buttons on the operation panel.

## **NOTE:**

When plugged in for the first time, all LED lights will shine for 2 seconds with sounds, which mean the unit is working properly. After the initialisation, all LED lights turn off and the unit shifts to Standby mode.



## 1. STAND-BY

Under standby mode, only **STAND-BY** button works. By pressing the standby button, the unit starts to work. The unit starts at LOW speed in NORMAL mode, with the LED indicators showing accordingly. The unit starts without timer and swing function. The unit will turn to **STAND-BY** mode by pressing this button, with a prolonged sound under working status.

- Body sensor starts at the first power on under STAND BY mode. When starting the unit again without power off, the fan will work in the same status before shut down. (Besides the timer and wind modes).  
(Body sensor is only available for some models)

## 2. FAN SPEED

By pressing **FAN SPEED** button when the unit is working, users can set wind speed in “**LOW - MED - HIGH**”, and circulates like this. The indicators on the display will display accordingly.

## 3. TIMER

The unit starts with no timer active. Users can set the timer by pressing the timer button as follows: **Off, 1h, 2h, 4h, 8h**. The light indicators on the display circulate accordingly with the selection. The fan will work in count-down mode and will shut down when the timer expires.

## 4. HORIZONTAL OSCILLATION/ BODY SENSOR

When under working status, press this button to set horizontal oscillation angles as follows: **0°**, **60°**, **90°**, **180°**, **360°**, **body detecting**. The light indicators on the display show accordingly.

- **BODY SENSOR (optional)**

The fan will start working in 360 degree oscillation after the activation of the body sensor and will set the minimum angle according to detected position of a user. You will hear a sound indicator after every detection. The fan will go back to the starting position after 360 degree oscillation and then turn to the direction where he detected a user. The unit will choose the proper oscillation angle automatically in the detection area.

- If the unit doesn't detect a user, the unit will detect again with oscillating 360 degree to detect again.
- If more users appeared after the angle was already chosen, users should press the button to start the sensor detection again.

### Activating the function:

- The body sensor is started 30 seconds after power on. You can hear the indication sound and the angle indication lights begin to shine continuously and circularly.
- Long press Horizontal Oscillation button for 2.5 seconds to start infrared body sensor function. You can hear the indication sound and the angle indication lights begin to shine continuously and circularly.
- Continuously press the Oscillation Horizontal button, the angle indication lights shift and the body sensor starts after the 360 degree.

**Detection distance:** Within 2m from the fan.

## 5. VERTICAL OSCILLATION

The unit starts with no vertical oscillation when powered on. Users can press the Vertical Oscillation button to set vertical oscillation under working status. The LED light indicators display accordingly. Press this button again to stop the vertical oscillation function.

## 6. MODE

The fan starts in “Normal” mode, press **MODE** button to switch as follows:

**Normal - Natural - Sleep - ECO.** The LED indicator changes accordingly.

(The LED indicators do not shine when in Normal mode, only in other modes).

Press the **MODE** button to set the wind mode, the working fan speeds for each mode are described below:

- Normal mode:
  - HI speed
  - MED speed
  - LOW speed
- Natural mode:  
Working rule for 3 natural wind (HI, MED, LOW ) as below.

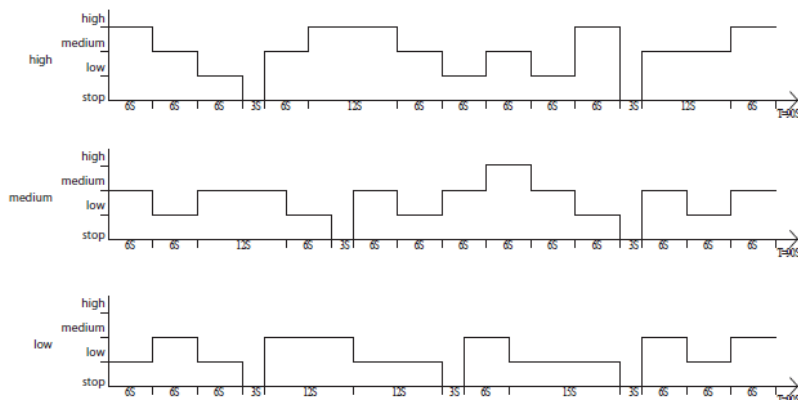

- **SLEEP mode :**
  - **HI Sleep mode:** 30 minutes “**HI**” natural wind, 30 minutes “**MED**” natural wind and the rest remains “**LOW**” natural wind speed.
  - **MED Sleep mode:** 30 minutes “**MED**” natural wind and the rest remains “**LOW**” natural wind.
  - **LOW Sleep mode:** Remains “**LOW**” natural wind
- **ECO mode:**

Under this mode, the machine automatically adjusts fan speed according to ambience temperature: Low speed when < 25°C; Hi speed when > 29°C; Med speed when 25°C~29°C.

**NOTE:**

(Speed button and the indicator for speed will not work under this mode.)

## 7. SAVE FUNCTION

The operation mode will be saved and the fan will start working in the same function before shut down. (Timer and sleep mode are not saved)

## 8. AUTO DIMMING FUNCTION

The LED lights will dim 30% of original brightness automatically after 1 minute of inactivity. If any button is pressed again, the brightness will return.

# REMOTE CONTROL OPERATION

---

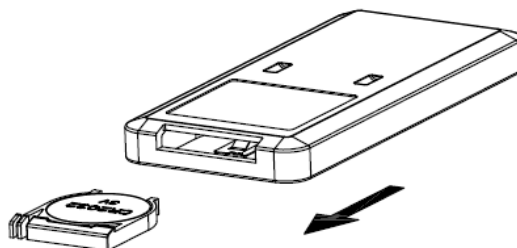

1. Open the RC cover on the back of RC and install the battery (CR2032 3V)
2. Please align the RC to the receiver. The RC will not work if the receiver is blocked. Please keep the RC properly, do not throw it on the floor.
3. Please pull out the battery cover as showed in below picture to replace the battery after power off. Please note the correct polarity. Push back the battery cover after replacement.











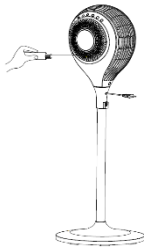

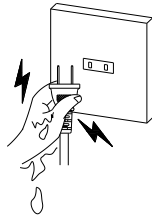

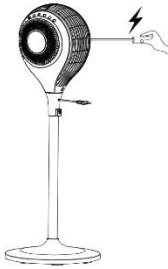



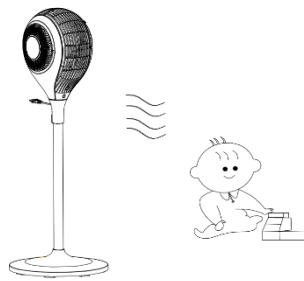

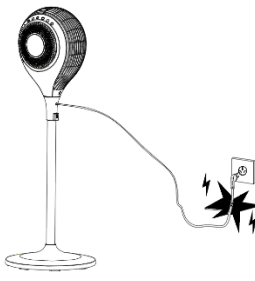



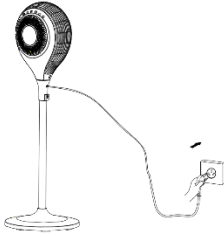

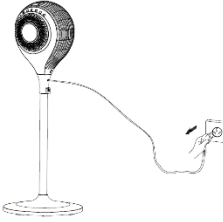

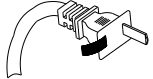
# SAFETY WARNINGS & SAFETY PRECAUTIONS

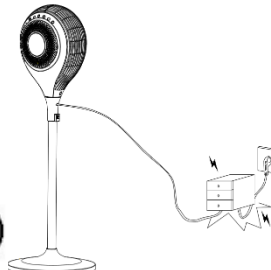
In order to use the product more conveniently and avoid any danger caused by wrong operation please pay close attention to the notices instructed by sign here. Read the instructions carefully.

## Symbol introduction

<b>Warning</b>		Something that may result in severe damage to the unit or your life.
<b>Forbidden</b>		Some actions that must be absolutely prohibited.
<b>Must Obay</b>		The content or actions that must execute absolutely as said.

<ul style="list-style-type: none"> <li>In the event of appliance failing to operate, all repairs must be undertaken by service center.</li> <li>Any disassembly may affect product safety.</li> </ul>  	<ul style="list-style-type: none"> <li>Do not touch the power cord with wet hands.</li> <li>Risk of electric shock.</li> </ul>   
<ul style="list-style-type: none"> <li>Do not stick any objects into the inlet and outlet of the unit.</li> <li>May lead to leakage, short circuit and possible damage to the product.</li> </ul>   	<ul style="list-style-type: none"> <li>Do not spray pesticides and flammable sprays around the product.</li> <li>May cause product damage.</li> </ul>  
<ul style="list-style-type: none"> <li>Avoid placing the air outlet directly in front of young children.</li> <li>May cause illness or affect the health of children.</li> </ul>  	<ul style="list-style-type: none"> <li>Do not pull or drag the power cord when unplugged.</li> <li>May cause damage to the power cord, and other dangers.</li> </ul>   

<ul style="list-style-type: none"> <li>• Making sure that the power cord is clean and that the plug is fully inserted.</li> </ul>  	<ul style="list-style-type: none"> <li>• Please stop working immediately and unplug when the product has unpleasant smell, abnormal sound under operation.</li> </ul>  
<ul style="list-style-type: none"> <li>• Do not use the fan if the power cord is exposed or damaged.</li> <li>• May cause short circuit and have the risk of leading to leakage fire.</li> <li>• If the power cord is damaged, it must be replaced by manufacturer, maintenance department or professionals in similarly department to avoid any dangers.</li> </ul>  	<ul style="list-style-type: none"> <li>• Do not fold or place heavy objects on the power cord.</li> <li>• May cause short circuit.</li> </ul>  
<ul style="list-style-type: none"> <li>• Do not wash the fan with moving water.</li> <li>• May lead to short circuit and possible damage to the product</li> </ul>  	<ul style="list-style-type: none"> <li>• Do not use the machine near a bathtub, shower or a pool.</li> <li>• Never use the machine directly under socket.</li> <li>• Keep the unit away from the walls, curtains and other combustible materials when using to avoid fire.</li> </ul> 
<ul style="list-style-type: none"> <li>• Power off the device and unplug the power cord when not using for a long time.</li> <li>• Avoid using the device, if there is any child or animal or disabled people or people who is lack of self-control</li> </ul> 	<ul style="list-style-type: none"> <li>• Use the power outlet that meets the inspection requirements, and the carrying capacity of the socket is no less than 10A/220V.</li> <li>• Ensure the power supply voltage is consistent with the specified voltage in the machine.</li> <li>• Make sure the service voltage when relocation.</li> </ul> 
<ul style="list-style-type: none"> <li>• Do not cover to avoid overheat.</li> <li>• Do not put anything on the machine.</li> </ul> 	

# MAINTENANCE & CLEANING

---

Before maintenance, please pull out the plug.

The performance of air outlet is affected if there is too much dust or dirt in the front grid cover of the fan.

## 1. Cleaning the fan at least by every other month:

- Turn off and unplug (Please unplug the fan before cleaning or it may cause an electric shock or mechanical injury).
- You can use a banister brush and normal detergent to wipe the unit. Do not use any chemical detergent.

## 2. Unit surface cleaning:

- Please use a wet cloth to wipe. Do not wash directly in water.
- Do not use any corrosive detergent or solvent for cleaning.
- Please unplug the fan before cleaning or it may cause an electric shock.

## 3. Product storage:

- If not used for a long time, please unplug and pack the unit to prevent dust from entering the body.
- Place in a dry and well ventilated place after packed.

# TECHNICAL PARAMETERS

---

Model	DF-AT0800F
Voltage	220-240 V~
Frequency	50 Hz
Power	65 W
Noise level	≤55 dB
Air volume	180 m <sup>3</sup> /h
Operation range	5~43 °C
Humidity	≤ 95 %
Dimensions	∅370 mm×1148.3 mm

# ENVIRONMENTAL PROTECTION

---

When using this device in the European countries, the following information's must be followed:

## DISPOSAL:

Do not dispose this product as unsorted municipal waste. Collection of such waste separately for special treatment is necessary. It is prohibited to dispose of this appliance in domestic household waste. For disposal, there are several possibilities:

- a) The municipality has established collection systems, where electronic waste can be disposed of at least free of charge to the user.
- b) When buying a new product, the retailer will take back the old product at least free of charge.
- c) The manufacture will take back the old appliance for disposal at least free of charge to the user.
- d) As old products contain valuable resources, they can be sold to scrap metal dealers.

Wild disposal of waste in forests and landscapes endangers your health when hazardous substances leak into the ground-water and find their way into the food chain.



WE RESERVE THE RIGHT TO MAKE CHANGES  
THAT DO NOT IMPAIR THE FUNCTIONALITY OF THE DEVICE.

The user manual can also be found at our website <http://www.gorenje.com>.

# NAVODILA ZA UPORABO IN NAMESTITEV



# OPOZORILA

---

- ⚠ Ta izdelek lahko uporabljajo otroci, starejši od 8 let. Starejše osebe in osebe z zmanjšanimi fizičnimi, zaznavnimi in psihičnimi sposobnostmi ali osebe brez izkušenj in poznavanja aparata lahko aparat uporabljajo le, če so pod nadzorom ali če dobijo ustrezna navodila za uporabo aparata na varen način in če se zavedajo morebitnih nevarnosti.
- ⚠ Otroci naj se z aparatom ne igrajo.
- ⚠ Otroci ne smejo čistiti ali vzdrževati tega izdelka brez nadzora.
- ⚠ Namestitev je potrebno opraviti v skladu z veljavnimi predpisi in v skladu z navodili proizvajalca.
- ⚠ V primeru, da je poškodovana priključna vrstica, jo lahko zamenja le proizvajalec, njegov servisni zastopnik ali ustrezno usposobljene osebe; le na ta način se izognete morebitni nevarnosti.
- ⚠ Nekateri deli tega izdelka se lahko zelo segrejejo in povzročijo opekline. Bodite posebej pozorni, če so v bližini otroci ali ranljive osebe.
- ⚠ Ventilatorja ne pokrivajte, ker lahko s tem povzročite resne okvare ali celo požar!
- ⚠ Da ventilator izključite, nastavite upravljalne elemente na IZKLOP, potem izvlecite vtič iz vtičnice.

## **Spoštovani, zahvaljujemo se vam za nakup našega izdelka.**

PRED NAMESTITVIJO IN PRVO UPORABO SAMOSTOJEČEGA VENTILATORJA NATANČNO PREBERITE TA NAVODILA.

Ta samostoječi ventilator je izdelan v skladu z ustreznimi standardi in preizkušen s strani ustreznih organov, kot je navedeno v potrdilu o varnosti. Njegove tehnične karakteristike so navedene na napisni ploščici.

## **ZNAČILNOSTI**

---

- Upravljalna plošča na dotik
- LED zaslon
- Programator: 1 h, 2 h, 4 h, 8 h
- Infrardeče daljinsko upravljanje
- (opcijsko) Senzor gibanja, zaznavanje položaja ljudi, samodejna izbira kota obračanja
- Samodejno vodoravno obračanje za 360° in navpično obračanje za 90°
- Kot vodoravnega obračanja 60°/90°/180°/360°
- 3 hitrosti vetra: počasi, srednje, hitro
- Načini vetra: normalno, naravno, spanje, EKO
- Zvočna opozorila

## SESTAVNI DELI

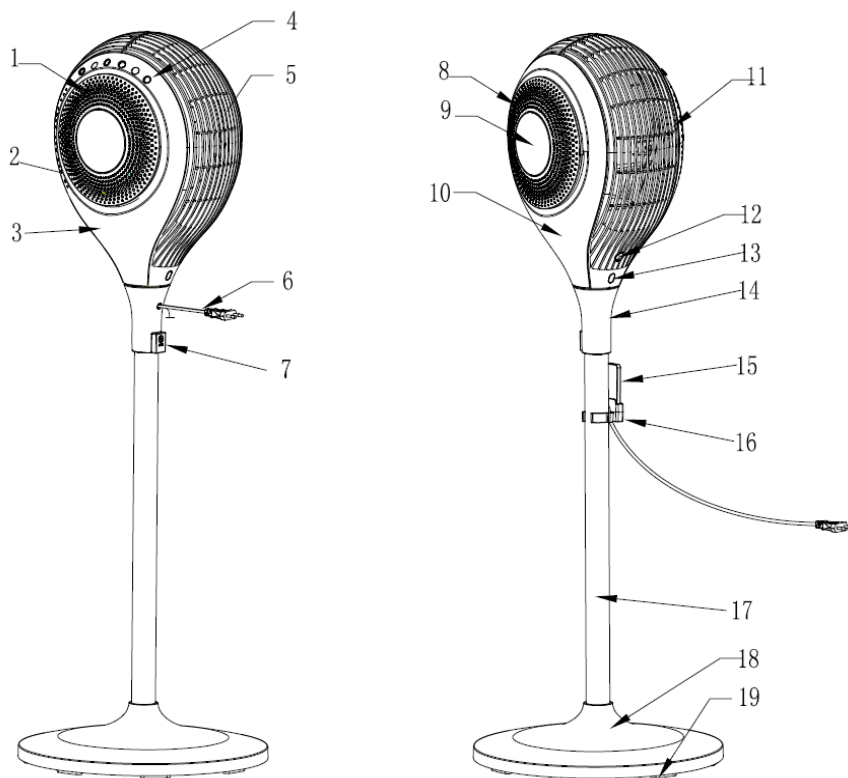

1. Vstop zraka desno
2. LED kontrolna lučka
3. Plošča na desni strani
4. Upravljalna plošča na dotik
5. Ohišje zadaj
6. Priključ na vrvica
7. Nosilec matice
8. Vstop zraka levo
9. Okrasni pokrov
10. Plošča na levi strani
11. Ohišje spredaj
12. Senzor gibanja
13. Sprejemnik daljinskega upravljanja
14. Nastavek za obračanje
15. Daljinski upravljalnik
16. Nosilec daljinskega upravljalnika
17. Stebriček
18. Podnožje
19. Utež podnožja

## GUMBI ZA UPRAVLJANJE IN ZASLON

- Gumbi za upravljanje

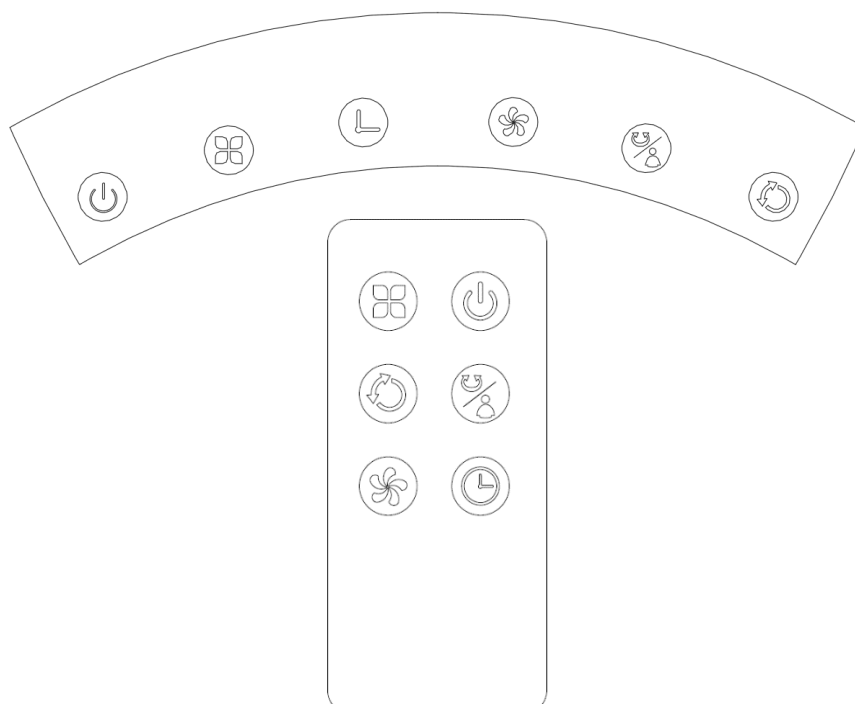

- **Zaslon**

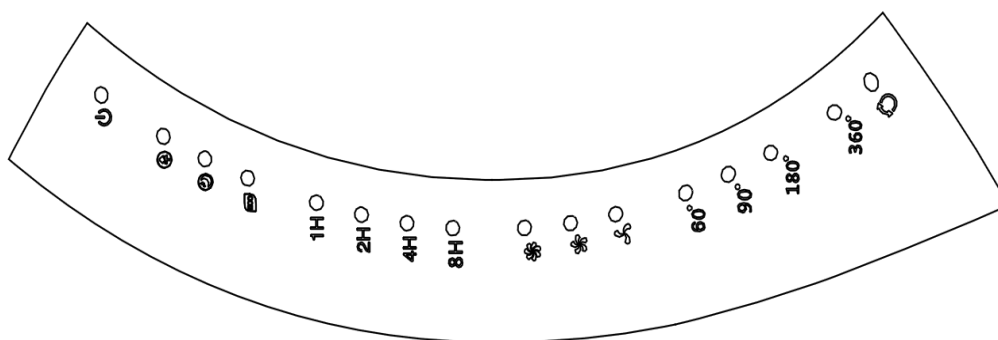

Tipka **VKLOP/IZKLOP (ON/OFF)**. S pritiskom na to tipko ventilator vklopite ali izklopite.



Tipka **NAČIN (MODE)**. Pritisnite to tipko, da izberete način delovanja (normalno-naravno-spanje-EKO).



Tipka **PROGRAMATOR (TIMER)**. Pritisnite to tipko, da nastavite funkcijo programiranega delovanja (1h-2h-4h-8h).



Tipka **HITROST VENTILATORJA (FAN SPEED)**. Pritisnite to tipko, da spremenite hitrost ventilatorja (POČASI-SREDNJE-HITRO).



Tipka **VODORAVNO OBRAČANJE (HORIZONTAL OSCILLATION)/SENZOR GIBANJA (BODY SENSOR)**. Pritisnite to tipko, da nastavite kot za vodoravno obračanje (0°, 60°, 90°, 180°, 360°). Pritisnite to tipko, da aktivirate SENZOR GIBANJA (nekateri modeli).



Tipka **NAVPIČNO OBRAČANJE (VERTICAL OSCILLATION)**. Pritisnite to tipko, da aktivirate navpično obračanje.

# NAMESTITEV

---

1. Vse dele vzemite iz embalaže.
2. Stebriček vtaknite v odprtino na podnožju in ga pritrdite z vijakom. (Slika 1)
3. Montirajte ogrodje ventilatorja na cev stebrička. (Slika 2)
4. Z vijakom pritrdite ogrodje ventilatorja in stebriček. (Slika 3)
5. Postavite ventilator na tla in ga vklopite. (Slika 4)

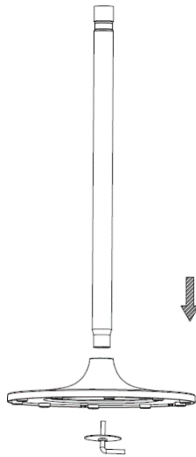

Slika 1

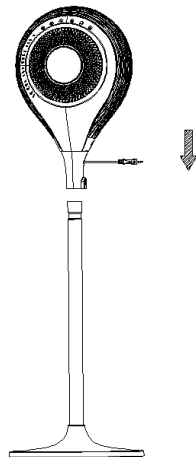

Slika 2

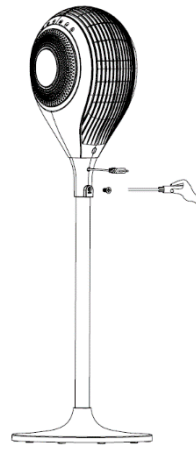

Slika 3

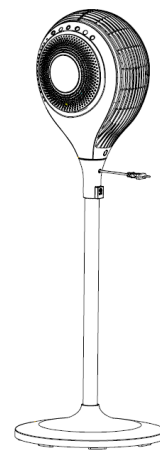

Slika 4

## NAVODILA ZA UPORABO

---

Ventilator je opremljen s tipkami na dotik, tako da lahko vse funkcije upravljate z dotikom ustrezne tipke na upravljalni plošči.

### **OPOMBA:**

Ob prvem priklopu vse LED lučke posvetijo za 2 sekundi, kar pomeni, da enota pravilno deluje. Po tem začetnem postopku LED lučke ugasnejo in enota preklopi v stanje pripravljenosti.

### **1. STANJE PRIPRAVLJENOSTI**

V stanju pripravljenosti deluje samo tipka **STANJE PRIPRAVLJENOSTI (STANDBY)**. Ob pritisku na tipko za stanje pripravljenosti enota začne delovati. Enota začne delovati POČASI v NORMALNEM načinu, kar kažejo LED pokazatelji. Enota deluje brez programatorja in funkcije nihanja. Enota se ob pritisku na to tipko preklopi na **STANJE PRIPRAVLJENOSTI**, s podaljšanim zvokom med delovanjem.

- Senzor gibanja se aktivira ob prvem vklopu v načinu STANJE PRIPRAVLJENOSTI. Ko enoto ponovno vklopite brez prekinitve napajanja, ventilator deluje v istem načinu, kot pred izklopom. (Poleg programatorja in načinov za veter.) (Senzor gibanja je vgrajen le pri nekaterih modelih.)

## 2. HITROST VENTILATORJA

Ob pritisku na tipko **HITROST VENTILATORJA (FAN SPEED)**, ko enota deluje, lahko nastavite hitrost vetra na "**POČASI - SREDNJE - HITRO**", in potem tako kroži. Pokazatelji na zaslonu kažejo ustrezní prikaz.

## 3. ČASOVNIK

Enota se vklopi brez aktiviranega časovika. Časovnik lahko nastavite s pritiskanjem tipk, kot sledi: **izklop, 1 h, 2 h, 4 h, 8 h**. Svetlobni pokazatelji na zaslonu krožijo skladno z izbiro. Ventilator deluje z odštevanjem in se izklopi, ko se nastavljeni čas izteče.

## 4. VODORAVNO OBRAČANJE / SENZOR GIBANJA

Ko ventilator deluje, pritisnite to tipko, da nastavite kote vodoravnega obračanja, kot sledi: **0°**, **60°**, **90°**, **180°**, **360°**, **zaznavanje gibanja**. Svetlobni pokazatelji na zaslonu prikazujejo odgovarjajoče stanje.

- **SENZOR GIBANJA (opsijsko)**

Ventilator začne delovati s 360 stopinjskim obračanjem po aktiviranju senzorja gibanja in nastavi minimalni kot v skladu z zaznanim položajem uporabnika. Po vsakem zaznavanju slišite zvočni signal. Ventilator gre nazaj v izhodiščni položaj po 360 stopinjskem obračanju in se potem obrne v smer, kjer je zaznal uporabnika. Enota samodejno izbere pravilni kot obračanja za področje zaznavanja.

- Če enota ne zazna uporabnika, ga ponovno poskuša zaznati preko 360 stopinjskega obračanja.
- Če se pojavi več ljudi potem, ko je kot že bil izbran, morate pritisniti tipko, da senzor ponovno prične z zaznavanjem.

### Aktiviranje funkcije:

- Senzor gibanja se aktivira 30 sekund po vklopu. Slišite lahko zvok in lučke za prikaz kota zasvetijo neprekinjeno in krožno.
- Tipko vodoravno obračanje pritisnite za 2,5 sekunde, da se aktivira funkcija infrardečega senzorja gibanja. Slišite lahko zvok in lučke za prikaz kota zasvetijo neprekinjeno in krožno.
- Pritisnite in držite tipko vodoravno obračanje, lučke za prikaz kota se pomaknejo in senzor gibanja se aktivira po 360 stopinjah.

**Razdalja zaznavanja:** Do 2 m od ventilatorja.

## 5. NAVPIČNO OBRAČANJE

Ko enoto vklopite, začne delovati brez navpičnega obračanja. Pritisnete lahko tipko navpično obračanje, da to obračanje nastavite med delovanjem. LED lučke svetijo skladno s stanjem. To tipko ponovno pritisnete, da funkcijo navpičnega obračanja zaustavite.

## 6. NAČIN DELOVANJA

Ventilator začne delovati v “normalnem” načinu, potem pritisnete tipko **NAČIN DELOVANJA**, da izbirate med: **Normalno - naravno - spanje - EKO**. LED pokazatelj se spreminja skladno s stanjem. (LED pokazatelji ne svetijo v normalnem načinu, samo v drugih načinih.) Pritisnete tipko **NAČIN DELOVANJA**, da nastavite nač in vetra; hitrosti delovanja ventilatorja so za vsak način prikazane spodaj:

- Normalni način:
  - HITRO (HI)
  - SREDNJE (MED)
  - POČASI (LOW)
- Naravni način:  
Pravilo delovanja za 3 naravne vetrove (HI, MED, LOW), kot je prikazano spodaj.

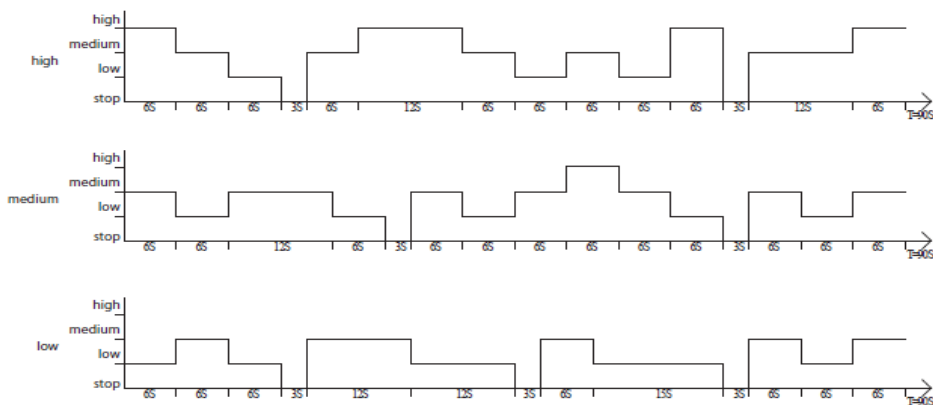

- **Način SPANJE HI:** 30 minut hitrost “**HI**” (HITRO) naravnega vetra, 30 minut hitrost “**MED**” (SREDNJA) naravnega vetra in preostalo je hitrost “**LOW**” (POČASI) naravnega vetra.
- **Način SPANJE MED:** 30 minut hitrost “**MED**” (SREDNJA) naravnega vetra in preostalo je hitrost “**LOW**” (POČASI) naravnega vetra.
- **Način SPANJE LOW:** Hitrost “**LOW**” (POČASI) naravnega vetra.

- **Način EKO**

Pri tem načinu enota samodejno nastavlja hitrost ventilatorja v skladu s sobno temperaturo: Počasi, ko je < 25 °C; hitro, ko je > 29 °C; srednja hitrost, ko je 25 °C~29 °C.

**OPOMBA:**

(V tem načinu tipka za hitrost in pokazatelj hitrosti ne delujeta.)

## 7. SHRANJEVANJE

Način delovanja se shrani in ventilator začne delovati na enaki nastavitvi, kot je bila pred izklopom. (Programator in spanje nista shranjena.)

## 8. SAMODEJNA ZATEMNITEV

LED lučke samodejno svetijo 30 % manj od originalne svetlosti po 1 minuti neaktivnosti. Ko ponovno pritisnete kakšno tipko, se svetlost povrne.

# ZAMENJAVA BATERIJE DALJINSKEGA UPRAVLJALNIKA

---

1. Odprite pokrov upravljalnika na hrbtni strani in vstavite baterijo (CR2032 3V).
2. Daljinski upravljalnik usmerite proti sprejemniku. Upravljalnik ne deluje, če je sprejemnik zakrit. Z daljinskim upravljalnikom ravnajte pravilno. Pazite, da vam ne pade na tla.
3. Pokrov za baterijo izvlecite, kot je prikazano na spodnji sliki in zamenjajte baterijo, ko je potrebno. Pazite, da jo pravilno obrnete. Po menjavi pokrov pritisnite nazaj.

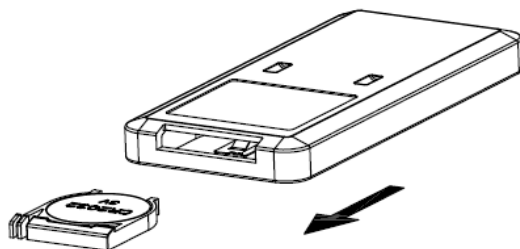













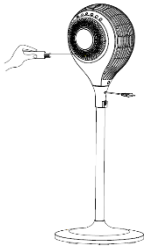

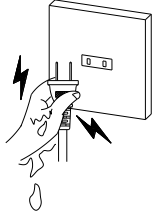







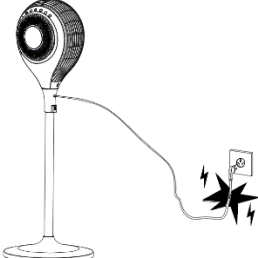

# VARNOSTNA IN PREVIDNOSTNA OPOZORILA

Da bo ta izdelek čim boljše deloval in da se izognete kakršni koli nevarnosti zaradi napačnega delovanja, preglejte in upoštevajte spodaj navedeno in uporabljene simbole. Navodila natančno preberite.

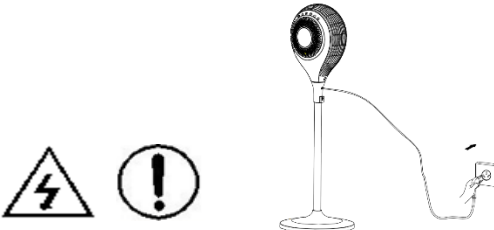
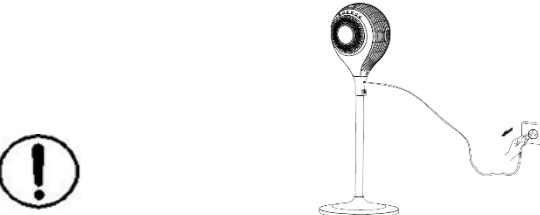
## Opis simbolov

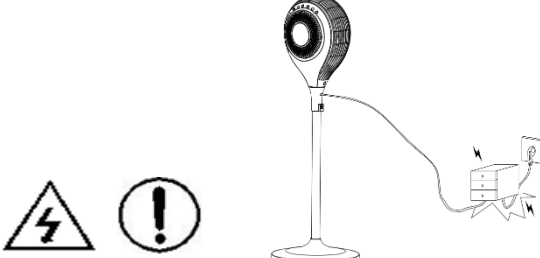
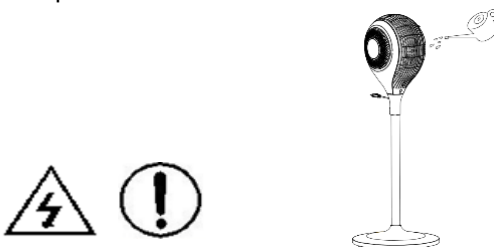
<b>Opozorilo</b> 	Nekaj, kar lahko ima za posledico resne poškodbe enote ali nevarnost za vaše življenje.
<b>Prepovedano</b> 	Nekatera dejanja, ki so absolutno prepovedana.
<b>Potrebno narediti</b> 	Vsebinska ali dejanja, ki jih je nujno potrebno izvesti, kot je navedeno.

<ul style="list-style-type: none"> <li>• V primeru, da enota ne deluje, mora vsa popravila opraviti servisni center.</li> <li>• Če karkoli demontirate, lahko to vpliva na varnost izdelka.</li> </ul>  	<ul style="list-style-type: none"> <li>• Priključne vrvice se ne dotikajte z mokrimi rokami.</li> <li>• Nevarnost električnega udara.</li> </ul>   
<ul style="list-style-type: none"> <li>• Ničesar ne natikajte na vhod in izhod enote.</li> <li>• To lahko povzroči uhajavi tok, kratek stik in poškodbe izdelka.</li> </ul>   	<ul style="list-style-type: none"> <li>• Okrog enote ne škropite s pesticidi in vnetljivimi razpršili.</li> <li>• Enota se lahko poškoduje.</li> </ul>  
<ul style="list-style-type: none"> <li>• Izhoda zraka ne usmerjajte neposredno pred male otroke.</li> <li>• Otroci lahko zbolijo, vpliva lahko na njihovo zdravje.</li> </ul>  	<ul style="list-style-type: none"> <li>• Da prekinete napajanje, ne vlecite za priključno vrvico.</li> <li>• S tem se lahko poškoduje priključna vrvica, pojavijo se lahko še druge nevarnosti.</li> </ul>   

<ul style="list-style-type: none"> <li>Preverite, da je priključna vrstica čista in da je vtič popolnoma vstavljen v vtičnico.</li> </ul> 	<ul style="list-style-type: none"> <li>V primeru neprijetnega vonja ali neobičajnega zvoka med delovanjem takoj ustavite delovanje in prekinite napajanje.</li> </ul> 
<ul style="list-style-type: none"> <li>Ventilatorja ne uporabljajte, če je priključna vrstica nezaščitena ali poškodovana.</li> <li>Pride lahko do kratkega stika, kar lahko povzroči požar.</li> <li>Poškodovano priključno vrstico lahko zamenja samo proizvajalec, vzdrževalni oddelek ali strokovnjak, da ne pride do nevarnosti.</li> </ul> 	<ul style="list-style-type: none"> <li>Priključne vrstice ne prepogibajte in nanjo ne polagajte težkih predmetov.</li> <li>Lahko pride do kratkega stika.</li> </ul> 
<ul style="list-style-type: none"> <li>Ventilatorja ne čistite pod tekočo vodo.</li> <li>To lahko povzroči kratek stik in poškodbe izdelka.</li> </ul> 	<ul style="list-style-type: none"> <li>Ventilatorja ne uporabljajte poleg kopalne kadi, tuša ali bazena.</li> <li>Ne uporabljajte ga neposredno pod vtičnico.</li> <li>Med uporabo ventilator postavite stran od sten, zaves in drugih vnetljivih materialov, da preprečite požar.</li> </ul> 
<ul style="list-style-type: none"> <li>Kadar ventilatorja dalj časa ne uporabljate, ga izklopite in izvlecite vtič priključne vrstice iz vtičnice.</li> <li>Izdelka ne uporabljajte v prisotnosti otrok, živali, invalidnih oseb ali oseb z zmanjšano samo-kontrolo.</li> </ul> 	<ul style="list-style-type: none"> <li>Uporabljena vtičnica se mora skladati z zahtevami inšpekcije in njena zmogljivost ne sme biti manjša od 10 A/220 V.</li> <li>Zagotovite, da se dovodna električna napetost sklada z napetostjo enote.</li> <li>Ob premestitvi preverite delovno napetost.</li> </ul> 
<ul style="list-style-type: none"> <li>Ventilatorja ne pokrivajte, da se ne pregreje.</li> <li>Na ventilator ne postavljajte ničesar.</li> </ul> 	

# VZDRŽEVANJE IN ČIŠČENJE

---

Pred vzdrževanjem izvlecite vtič iz omrežne vtičnice.

Zmogljivost izhajanja zraka se zmanjša, če se na prednjem pokrovu mreže ventilatorja nabere preveč prahu in umazanije.

## 1. Čiščenje ventilatorja najmanj vsak drugi mesec:

- Ventilator izklopite in izvlecite vtič (vtič izvlecite pred čiščenjem, ker lahko pride do električnega udara ali mehanske poškodbe).
- Za čiščenje lahko uporabite metlico in običajni detergent ali topilo. Ne uporabljajte kemičnih detergentov.

## 2. Čiščenje površine ventilatorja:

- Obrišite z vlažno krpo. Ne čistite neposredno v vodi.
- Za čiščenje ne uporabljajte korozivnih detergentov ali topil.
- Pred čiščenjem izvlecite vtič, v nasprotnem primeru lahko pride do električnega udara.

## 3. Shranjevanje ventilatorja:

- Kadar ventilatorja dalj časa ne nameravate uporabljati, ga izklopite in zapakirajte, da se v ohišju ne nabere prah.
- Ko ga zapakirate, ga postavite v suh in dobro prezračevan prostor.

# TEHNIČNI PODATKI

---

Model	DF-AT0800F
Napetost	220-240 V~
Frekvenca	50 Hz
Moč	65 W
Raven hrupa	≤55 dB
Volumen zraka	180 m <sup>3</sup> /h
Delovno območje	5~43 °C
Vlažnost	≤ 95 %
Mere	Ø370 mm×1148,3 mm

# VARSTVO OKOLJA

---

V evropskih državah je potrebno ob uporabi tega izdelka upoštevati naslednje informacije:

## ODLAGANJE ODPADKOV:

Tega izdelka ne oddajte med mešane komunalne odpadke. Za takšne odpadke je potrebno ločeno zbiranje s kasnejšo posebno obdelavo. Tega izdelka v nobenem primeru ne dajte med gospodinjske odpadke. Odlaganje odpadnih aparatov je možno na več načinov:

- a) Občinska uprava zagotavlja ustrezne sisteme zbiranja, kamor lahko brezplačno oddate elektronske odpadke.
- b) Ob nakupu novega izdelka prodajalec brezplačno prevzame star izdelek.
- c) Proizvajalec brezplačno vzame nazaj star odpadni aparat.
- d) Ker stari izdelki vsebujejo dragocene materiale, jih lahko prodate trgovcem s starimi kovinami.

Divje odlaganje odpadkov v gozdove oz. v naravo ogroža vaše zdravje, ker nevarne snovi prodirajo v podtalnico in tako pridejo v prehranjevalno verigo.



PRIDRŽUJEMO SI PRAVICO DO SPREMEMB,  
KI NE VPLIVAJO NA FUNKCIONALNOST APARATA.

Ta navodila lahko poiščete tudi na naši spletni strani <http://www.gorenje.com>.