

GB

IE

MT

**DETAILED
INSTRUCTIONS FOR USE
OF A COMBI STEAM
OVEN**

gorenje

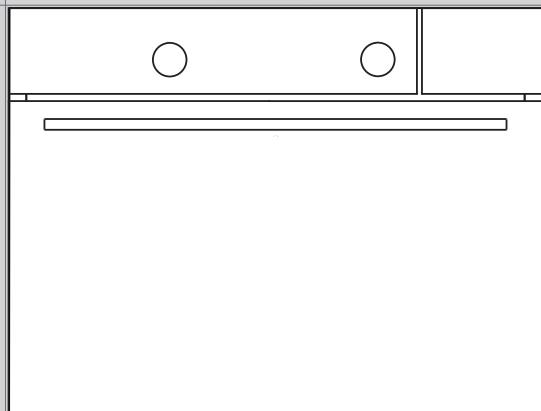

We thank you for your trust and the purchase of our appliance.

This detailed instruction manual is supplied to make the use of this product easier. The instructions should allow you to learn about your new appliance as quickly as possible.

Make sure you have received an undamaged appliance. If you do find transport damage, please contact the seller from which you purchased the appliance, or the regional warehouse from which it was supplied. The telephone number can be found on the invoice or on the delivery note.

Instructions for installation and connection are supplied on a separate sheet.

Instructions for use are also available at our website:

www.gorenje.com



Important information



Tip, note

CONTENTS

4 IMPORTANT SAFETY INSTRUCTIONS 6 Before connecting the appliance 7 COMBI STEAM OVEN 11 Technical specifications 12 Control unit (depending on the model)	INTRODUCTION
14 BEFORE USING THE APPLIANCE FOR THE FIRST TIME 14 Steam cooking 15 Filling the water tank	PREPARING THE APPLIANCE FOR THE FIRST USE
16 STEPS OF THE COOKING PROCESS (1-6) 16 Step 1: SWITCHING ON AND SETTINGS 20 Step 2: CHOOSING THE COOKING SYSTEM 22 Step 3: CHOOSING THE SETTINGS 26 Step 4: SELECTING ADDITIONAL FUNCTIONS 27 Step 5: STARTING THE COOKING PROCESS 27 Step 6: SWITCHING OFF THE OVEN 28 DESCRIPTIONS OF SYSTEMS (COOKING MODES) AND COOKING TABLES	COOKING STEPS
49 MAINTENANCE & CLEANING 50 Conventional oven cleaning 51 Using the steam clean function to clean the oven 52 Cleaning the steam system 53 Cleaning the filter foam 54 Removing and cleaning the wire guides 55 Removing and inserting the oven door 58 Removing and inserting the oven door glass pane 59 Replacing the bulb	MAINTENANCE & CLEANING
60 TROUBLESHOOTING TABLE	TROUBLE-SHOOTING
61 DISPOSAL	OTHER

IMPORTANT SAFETY INSTRUCTIONS

CAREFULLY READ THE INSTRUCTIONS AND SAVE THEM FOR FUTURE REFERENCE.

This appliance can be used by children aged from 8 years and above and persons with reduced physical, sensory or mental capabilities or lack of experience and knowledge if they have been given supervision or instruction concerning use of the appliance in a safe way and understand the hazards involved. Children shall not play with the appliance. Cleaning and user maintenance shall not be made by children without supervision.

WARNING: The appliance and its accessible parts become hot during use. Care should be taken to avoid touching heating elements. Children less than 8 years of age shall be kept away unless continuously supervised.

WARNING: Accessible parts may become hot during use. Young children should be kept away.

During use the appliance becomes hot. Care should be taken to avoid touching heating elements inside the oven.

Only use the temperature probe recommended for use in this oven.

WARNING: Ensure that the appliance is switched off before replacing the lamp to avoid the possibility of electric shock.

Do not use harsh abrasive cleaners or sharp metal scrapers to clean the oven door glass/ the glass of hinged lids of the hob (as appropriate), since they can scratch the surface, which may result in shattering of the glass.

Do not use steam cleaners or high pressure cleaners to clean the appliance as this may result in an electric shock.

Means for disconnection must be incorporated in the fixed wiring in accordance with the wiring rules.

If the supply cord is damaged, it must be replaced by the manufacturer, its service agent or similarly qualified persons in order to avoid a hazard (only for appliances supplied with connection cord).

The appliance must not be installed behind a decorative door in order to avoid overheating.

The appliance is intended for household use. Do not use it for any other purpose, such as room heating, drying of pets or other animals, paper, fabrics, herbs etc. As this may lead to injury or fire hazard.

The appliance may only be connected to the power mains by an authorized service technician or expert. Tampering with the appliance or nonprofessional repair thereof may result in risk of severe injury or damage to the product.

If the power cords of other appliances located near this appliance are caught in the oven door, they may be damaged, which may in turn result in a short circuit. Therefore, keep the power cords of other appliances at a safe distance.

Do not line the oven walls with aluminium foil and do not place baking trays or other cookware on the oven bottom. Aluminium foil would prevent air circulation in the oven, hinder the cooking process, and ruin the enamel coating.

Oven door become very hot during operation. A third glass is installed for extra protection, reducing the temperature of the outside surface (only with some models).

Oven door hinges may be damaged when under excessive load. Do not place heavy pans on open oven door and do not lean against open oven door when cleaning the oven cavity. Never stand on the open oven door and do not let children to sit on it.

Do not lift the appliance by holding it by the door handle.

Appliance operation is safe with and without tray guides.

Make sure the vents are never covered or obstructed in any other way.

Safe and correct use of the steam oven

Leave the appliance at room temperature for some time before connecting it to the power mains to allow all components to adapt to room temperature. If the oven is stored at a temperature near or below freezing point, there is a danger for some components, especially the pumps.

The appliance should not operate in an environment with a temperature below 5 °C. Below this temperature, the appliance may not operate correctly. If the appliance is switched on in such conditions, the pump could be damaged.

If the appliance does not work correctly, disconnect it from the power mains.

Do not store items in the oven, which could cause danger when the oven is switched on.

Do not use distilled water that is not suitable for ingestion (e.g. distilled water for batteries, to which acid is added).

When you open the oven door (with steam systems) after the end or during steam

cooking, make sure to open the door to the fully open position; otherwise, the steam from the oven cavity could negatively affect the control panel operation.

After the steam cooking is completed, there is some residual steam in the oven. Open the oven door carefully, as there is danger of scalding with steam. Clean the oven once it has cooled down to room temperature.

After the cooking process, the remaining water in the steam system is pumped back into the water tank. Therefore, the water there could be hot. Be careful when emptying the water tank.

To prevent the build-up of limescale, leave the oven door open after cooking to allow the oven cavity to cool down to room temperature.

It is inadvisable to open the door during the steam cycle, as this will increase power consumption and formation of water condensate.



WARNING!

Risk of burns and damage to the appliance.

- Released Steam can cause burns: Be careful when you open the appliance door when the function is activated. Steam can release.



WARNING!

Use only water as the liquid. Do not use filtered (demineralised) or distilled water.

BEFORE CONNECTING THE APPLIANCE:



Carefully read the instructions for use before connecting the appliance. Repair or any warranty claim resulting from incorrect connection or use of the appliance shall not be covered by the warranty.

COMBI STEAM OVEN

(DESCRIPTION OF THE OVEN AND EQUIPMENT - DEPENDING ON THE MODEL)

The figure represents one of the built-in appliance models. Since the appliances for which these instructions were drawn up may have different equipment, some functions or equipment may be described in the manual that may not be present in your appliances.

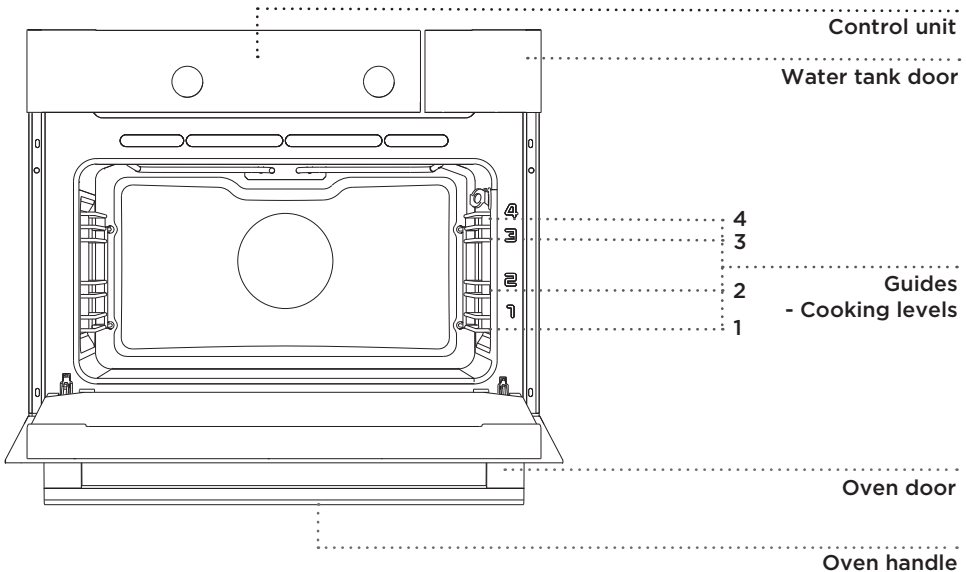

WIRE GUIDES

Wire guides allow preparation of the food on four levels (please note that the levels/guides are counted from the bottom up).

Guides 3 and 4 are intended for grilling.

TELESCOPIC PULL-OUT GUIDES

Telescopic pull-out (extendible) guides may be fitted for the second and third level.

Pull-out guides can be partly or fully extendible.

OVEN DOOR SWITCH

The switches deactivate oven heating, the fan, and the microwaves when the oven door is opened during the cooking process. When the door is closed, the switches turn the heaters and microwaves back on.

COOLING FAN

The appliance is fitted with a cooling fan that cools the housing and the appliance control panel.

EXTENDED OPERATION OF THE COOLING FAN

After the oven is switched off, the cooling fan continues to operate for a short while in order to provide additional cooling for the oven. (Extended cooling fan operation depends on the temperature in the center of the oven.)

OVEN EQUIPMENT AND ACCESSORIES (depending on the model)

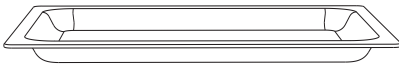

GLASS BAKING DISH is used for cooking with all oven systems and for cooking with microwaves. It can also be used as a serving tray.



The **GRID** is used for grilling or as support for a pan, baking tray or baking dish with the food.



There is a safety latch on the grid. Therefore, the grid has to be lifted slightly at the front when pulling it out from the oven.

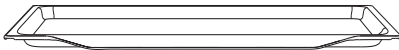

The **SHALLOW BAKING SHEET** is used for baking pastry and cakes.

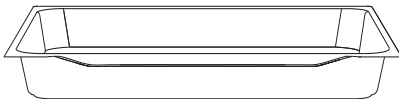

The **DEEP BAKING TRAY** is used for roasting meat and baking moist pastry. It can also be used as a drip tray.



Never place the deep baking tray in the first guide during the cooking process, except when grilling food or using the roasting spit and you are only using the deep tray as a drip tray.



As baking accessories heat up, their form may change. This does not affect their functionality and their original form will be restored when they cool down.

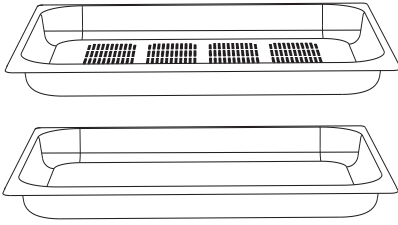

STEAM SET (INOX) is used for steam cooking. Place the perforated tray in the middle level and the drip tray one level below.

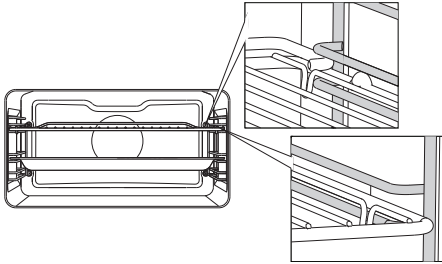

The grid or the tray should always be inserted into the groove between the two wire profiles.

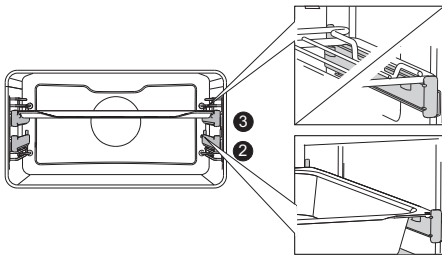

With telescopic extendible guides, first pull out the guides of one level and place the grid or the baking tray onto them. Then, push them in with your hand as far as they will go.

 Close the oven door when the telescopic guides are retracted all the way into the oven.

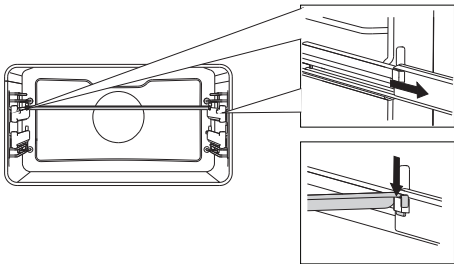

SYNCHRONIZATION BAR

The bar can be installed or removed on the fully retractable telescopic guides. First, completely pull out both guides of the desired level. Insert the bar into the two slots on the guides and push the guides in with your hand until they stop.

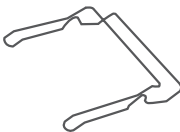

BAKING PAN SUPPORT allows easy removal of baking pans from the oven while they are still hot.

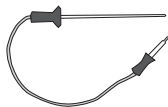

PROBE for roasting larger chunks of meat.

(Depending on the model)

DESCALING AGENT for cleaning the steam system.

TEST PAPER STRIP for testing water hardness.

MECHANICAL DOOR LOCK prevents the opening of oven door until the lock is released.

To open it, gently push your thumb to the right while pulling the door outwards.



The appliance and some of the accessible parts tend to heat up during cooking. Use oven mitts.

TECHNICAL SPECIFICATIONS

(DEPENDING ON THE MODEL)

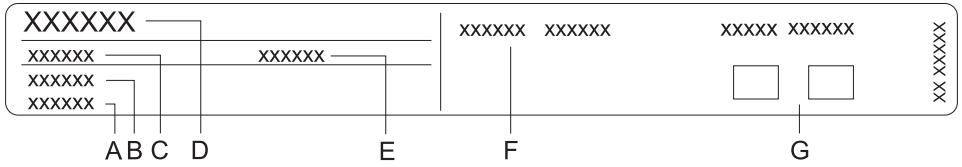

- A Serial number
- B Code/ID
- C Type
- D Brand
- E Model
- F Technical data
- G Compliance symbols

The rating plate indicating the basic information about the appliance is located at the edge of the oven and it is visible when the oven door is opened.

CONTROL UNIT

(DEPENDENT ON THE MODEL)

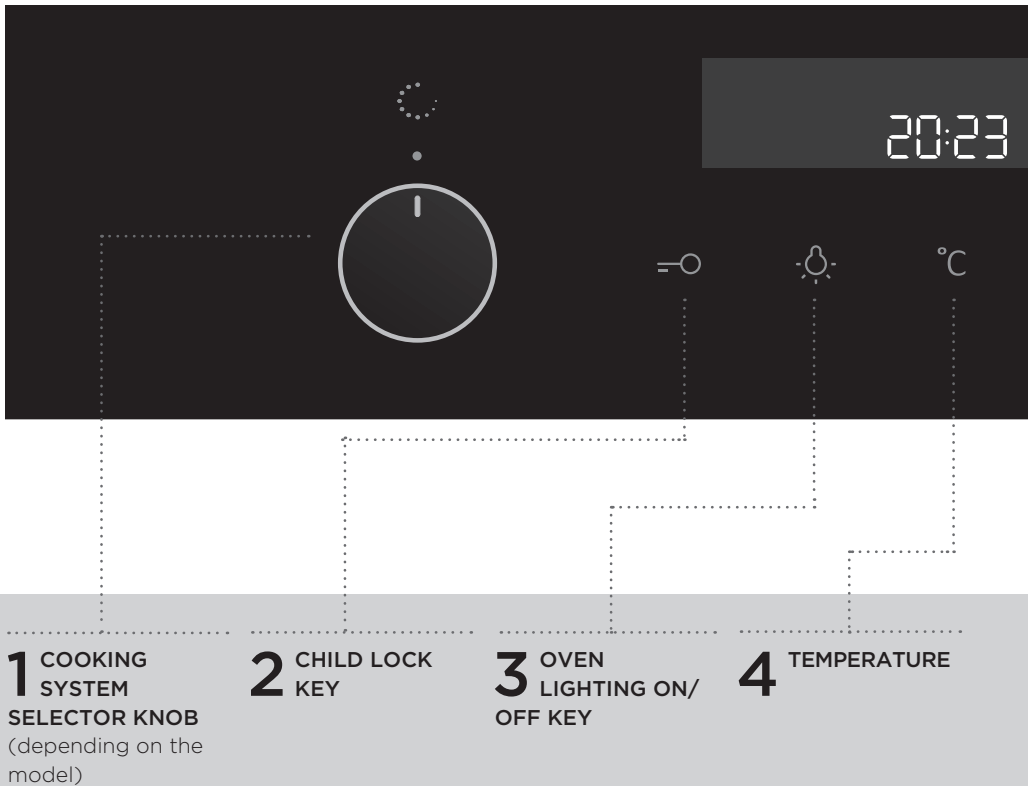

NOTE:

Symbols of cooking systems may be located on the knob or on the front panel (depending on the appliance model).

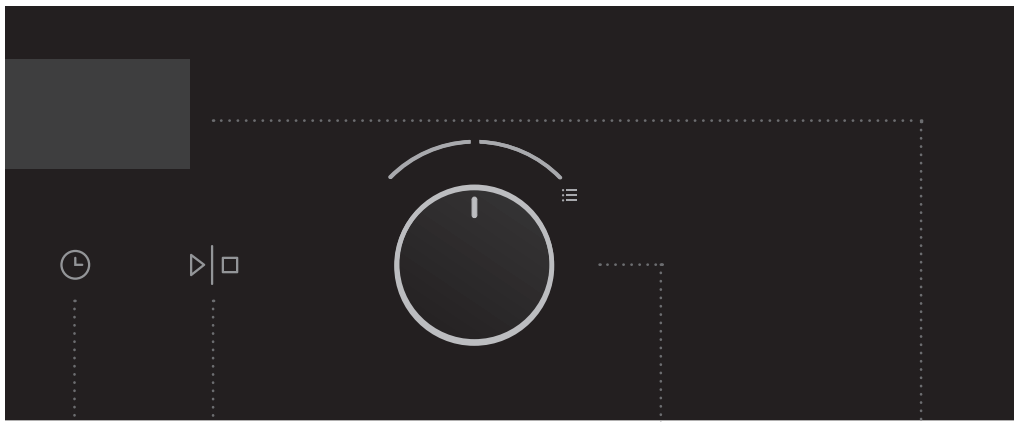

5 ELECTRONIC PROGRAM TIMER

- Cooking duration
- End of cooking
- Alarm
- Clock

6 START/STOP KEY
Use this key to start or stop the program.

7 SETTINGS KNOB (-/+)
Use this knob to set the time, temperature.

8 COOKING INFORMATION AND CLOCK DISPLAY

NOTE:

The keys will respond better if you touch them with a larger area of your fingertip. Each time you press a key, a short acoustic signal will be sounded.

BEFORE USING THE APPLIANCE FOR THE FIRST TIME

Upon receiving the appliance, remove all parts, including any transport equipment, from the oven.

Clean all accessories and utensils with warm water and regular detergent. Do not use any abrasive cleaners.

When the oven heats up for the first time, the characteristic smell of a new appliance will be emitted. Ventilate the room thoroughly during the first use.

STEAM COOKING

Healthy and natural, steam cooking preserves the full flavour of foods. This cooking method releases no odours. There is no need to add salt to the water or to add herbs and spices.

Following are the advantages of steam cooking:

Cooking (braising, roasting) starts before the temperature inside the oven reaches 100 °C.

Slow cooking (braising, roasting) is also possible at lower temperatures.

It is healthy: vitamins and minerals are well preserved because only a small share of them is dissolved in the condensation water that touches the food.

There is no need to add any fat during the cooking process. The steam maintains the taste of food. It does not add odours, nor the taste of the grill or the pan. Furthermore, it takes nothing away because the food is not diluted in the water. Steam does not spread the flavour or smell; therefore, meat or fish can be cooked together with vegetables. Steam is also suitable for blanching, defrosting and reheating or keeping the food warm.

FILLING THE WATER TANK

The tank allows for independent water supply to the steamer. The tank volume amounts to approx. 1.3 litres (maximum water level – see marking). This amount of water allows approximately 3 hours of cooking time with max. steam cycle (hot air with steam on "high" system).

 Clean the water tank before the first use.



Always fill the water tank with clean and cool water from the pipeline, bottled water without additives, or distilled water suitable for use in cooking. Water that is poured into the water tank should be at a temperature of 20 °C (+/- 10 °C).

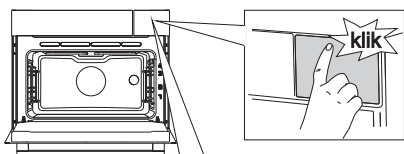

1 Press on the spot with the sticker to open the tank door.

 The sticker can be later removed.

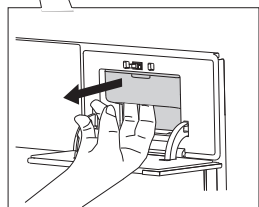

2 Remove the water tank from the housing by grabbing the notch.

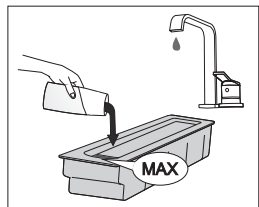

3 Open the lid. Wash the tank with water. Re-assemble the tank. Before use, add fresh water up to the MAX marking on the tank.

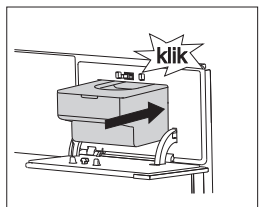

4 Push the water tank back into the housing to the final position (until the short click). Then, press the tank door to close it.

 After the cooking process, the remaining water in the steam system is pumped back into the water tank. The lid and the water tank can be washed with standard non-abrasive liquid cleaners or in a dishwasher.

STEPS OF THE COOKING PROCESS (1-6)

STEP 1: SWITCHING ON AND SETTINGS

After connecting your appliance or after an extended power outage, 12:00 will flash on the display and the symbol will light up.

All the settings as follows:

SETTING THE CLOCK

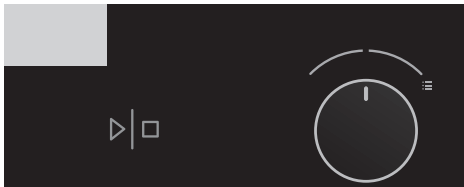

1 Rotate the SETTINGS KNOB (-/+) and first set the minutes; then, the cursor will switch to hours. After three seconds, the settings will be saved.

 Turning the knob farther to the right or to the left will change the settings more quickly.

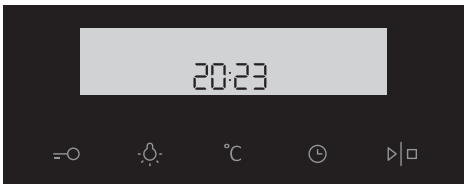

2 Confirm by pressing START/ STOP. If nothing is pressed within the next three seconds, the setting will be stored automatically.

 The oven will also work if the clock is not set. However, timer functions are not available in this case (see chapter: SETTING THE TIMER FUNCTIONS).

After a few minutes of idling, the appliance will switch to standby mode.

SETTINGS

To change the settings, rotate the setting knob to the right and hold it for three seconds. Press the start/sop icon to scroll through respective settings or parameters. To change a parameter, rotate the setting knob to the right or to the left.

BRIGHTNESS LEVEL

Select between three different options of brightness levels. Mid level is pre-set. Levels can be set by rotate knob.



Brightness level low

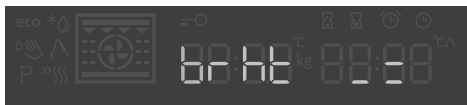

Brightness level mid



Brightness level max

SOUND LEVEL

Mid level is pre-selected. Sound levels can be set by rotate knob.



Volume level low



Pre-set mid sound level



Volume level max



Volume level off

WATER HARDNESS (active only on steam ovens)

Water hardness test should be carried out before first use.

Soak the test paper strip (supplied with the appliance) in water for one (1) second.

Wait one minute and observe the number of stripes on the paper. Enter the information on the number of stripes into the appliance.

	4 green stripes	Soft	Hrd 1
	1 red stripe	Slightly hard	Hrd 2
	2 red stripes	Medium hard	Hrd 3
	3 red stripes	Hard	Hrd 4
	4 red stripes	Very hard	Hrd 5

You can selected between five different options of water hardness levels. Water hardness level 5 is pre-set, text is visible. Levels can be set by rotating knob.



DECALTINATION (active only on steam ovens)

You can activate decalcination process by selecting "on" or "off" with jogger (rotate) knob and later by pressing the start/stop icon to confirm it. Decalcination "on" is pre-set.



STEP1 - Add the descaling agent into the water tank.

STEP2 - Descaling procedure complete. Please remove the liquid, rinse the water tank and add fresh water for the rinsing process.



STEP3/End - Rinsing process complete.
Clean the tank and wipe the oven.
Also clean the filter foam (see chapter
CLEANING THE FILTER FOAM)

END

By pressing the start/stop icon, user can go out of settings menu back to standby mode. You can go out of settings manu also if you hold selection knob on the left for 3 sec, or it you turn the system knob.



To change the settings, rotate the setting knob to the right and hold it for three seconds. Press the start/sop icon to scroll through respective settings or parameters. To change a parameter, rotate the setting knob to the right or to the left.



After a power outage or after the appliance is switched off, the additional function settings will remain stored for no more than a few minutes. Then, all settings, except for the acoustic signal and child lock will be reset to factory defaults.

STEP 2: CHOOSING THE COOKING SYSTEM

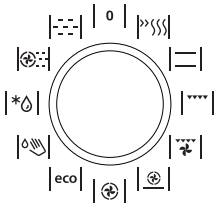





Rotate the knob (left and right) to select 0 COOKING SYSTEM (see program table). The selected icon will appear on the display.



Settings can also be changed during operation.

SYSTEM	DESCRIPTION	PRE-SET TEMPERATURE (°C)	MIN - MAX TEMPERATURE (°C)
COOKING SYSTEMS			
	RAPID PREHEAT Use this function if you wish to heat the oven to the desired temperature as quickly as possible. This function is not appropriate for cooking food. When the oven heats up to the desired temperature, the heating process is completed.	160	30-230
	UPPER AND BOTTOM HEATER The heaters in the bottom and in the ceiling of the oven cavity will radiate heat evenly into the oven interior. Pastry or meat can only be baked/roasted at a single height level.	200	30-230
	GRILL The upper heater and the grill heater will operate. The heat is radiated directly by the grill heater installed in the oven ceiling. To boost the heating effect, the upper heater is activated as well. This combination is used for grilling a smaller amount of open sandwiches, meat or beer sausages, and for toasting bread.	230	30-230
	GRILL WITH FAN Grill heater and the fan will operate. This combination is used to grill meat and to roast larger chunks of meat or poultry at a single height level. It is also appropriate for dishes au gratin and for browning to a crispy crust.	170	30-230
	HOT AIR AND BOTTOM HEATER The bottom heater, the round heater, and the hot air fan will operate. This is used to bake pizza, moist pastry, fruitcakes, leavened dough and shortcrust.	200	30-230
	HOT AIR Round heater and the fan will operate. The fan installed in the back wall of the oven cavity makes sure the hot air constantly circulates around the roast or pastry. This mode is used for roasting meat and baking pastry at several levels simultaneously.	180	30-230

SYSTEM	DESCRIPTION	PRE-SET TEMPERATURE (°C)	MIN - MAX TEMPERATURE (°C)
eco	ECO COOKING ¹⁾ In this mode, power consumption during the cooking process is optimized. This mode is used for roasting meat and baking pastry.	180	/
	STEAM CLEAN Steam moistures oven cavity. Use this function to remove stains and food residues from the oven.	70	/
AUTOMATIC SYSTEM			
	DEFROSTING The air circulates with no heaters activated. Only the fan will be activated. This is used to slowly thaw frozen food.	/	/
COMBINED SYSTEMS/STEAM SYSTEMS			
	COMBI STEAM+HOT AIR Used for baking and defrosting. They allow quick and efficient cooking without changing the colour or shape of the food. Three options are available: - HIGH: cooking escalopes, steaks and smaller chunks of meat - MEDIUM: reheating cool/frozen meals, cooking fish fillets and vegetables au gratin - LOW: cooking large chunks of meat (roast, whole chicken), baking risen dough (bread and rolls), cooking lasagna etc.	160	30-230
	STEAM ²⁾ / SOUS VIDE This system is used for cooking meat, vegetable, fruit and side dishes. SOUS VIDE is a slow cooking procedure with food vacuum sealed and cooked at a specific temperature that is accurately maintained. The sous vide method is suitable for cooking meat, fish, and all types of fruit and vegetables. Food cooked in this way is juicy and it develops a fuller flavour.	50	30-95

¹⁾ It is also used for determining the energy efficiency class pursuant to the EN 60350-1 standard.

In this mode, the actual temperature in the oven is not displayed due to a special appliance operation algorithm and use of residual heat.

²⁾ Degree adjustment.

STEP 3: CHOOSING THE SETTINGS

Each cooking system features basic or default settings which can be adjusted.

Adjust the settings by pressing the relevant key (before pressing the START/STOP key). Some settings are not available with some programs; an acoustic signal will remind you of such cases.

CHANGING THE COOKING TEMPERATURE AND STEAM FUNCTION

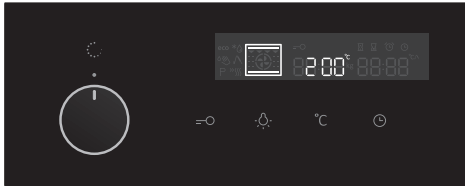

1 Select the COOKING SYSTEM. Selected icon will appear on the display and PRESET TEMPERATURE will flash.

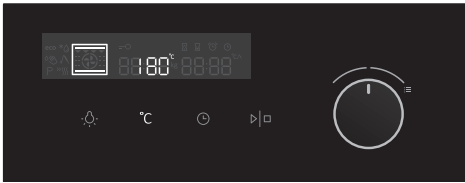

2 Select the COOKING SYSTEM. Selected icon will appear on the display and PRESET TEMPERATURE will flash.

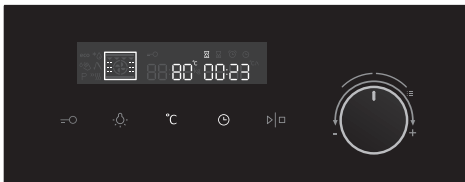

3 Touch the TEMPERATURE and TIME KEY and later rotate jogger knob to select the parameters.

 Maximum temperature or power is limited in some systems.

When selecting the combi steam program, first select the desired temperature and time. After confirming with START key, »int« and level bars will appear on the display to indicate the steam intensity setting (default setting is »mid«). Use the right knob to choose between three different steam intensity levels. Press the START key again to confirm the selected intensity level and start the combi steam program.

STEAM INTENSITY LEVELS



Steam intensity level low



Steam intensity level mid



Steam intensity level high

TIMER FUNCTIONS

First rotate the COOKING SYSTEM SELECTOR KNOB; then, set the temperature.

Touch the TIMER key several times to select the symbol.

The icon for the selected timer function will light up and the adjustable cooking start/end time will flash on the display. Other icons are dimly lit.

Press START to start the cooking process. ELAPSED COOKING TIME will be displayed.

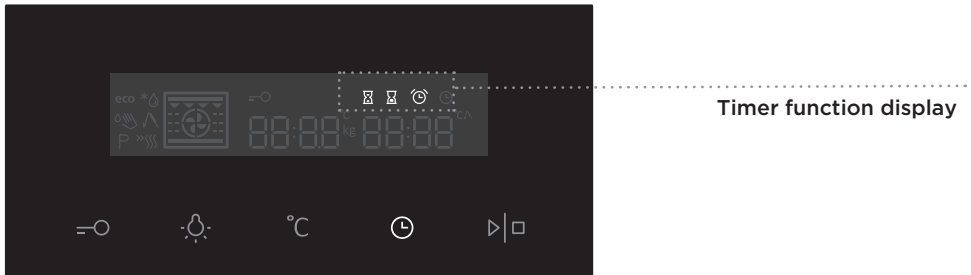

Setting the cooking time

In this mode, you can define the duration of oven operation (cooking time). Set the desired cooking time. First set the minutes, then the hours. Icon and cooking time are displayed on the display unit.



Setting the delayed start

In this mode, you may specify the duration of the cooking process (cooking time) and the time when you wish the cooking process to stop (end time). Make sure the clock is accurately set to current time.

Example:

Current time: noon

Cooking time: 2 hours

End of cooking: 6 pm

First set the OPERATION DURATION (2 hours). Touch the CLOCK button again and select END OF OPERATION. The display automatically shows a flashing sum of the time of day and duration of operation of the oven (14:00).

Set the time for the end of baking (18:00)

Press START to start the cooking process. The timer will wait for the time to start the cooking process and the symbol will be lit up. The oven automatically switches on (at 4 pm) and stops operating and the selected time (at 6 pm).



Setting the minute minder

The minute minder can be used independently of the oven operation. The longest possible setting is 24 hours. During the last minute, the minute minder is displayed in seconds.



After the set time expires, the oven will automatically stop operating (end of cooking). An acoustic signal will be heard which you may turn off by touching any key. After one minute, the acoustic signal will be switched off automatically.

All timer functions can be cancelled by setting the time to "0".

After a few minutes of idling, the appliance will switch to standby mode.

STEP 4: SELECTING ADDITIONAL FUNCTIONS

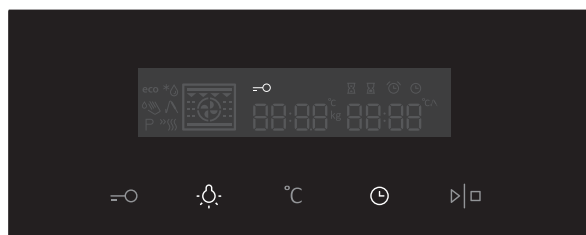

Activate/deactivate the functions by pressing the desired key or a combination of keys.

 Some functions are not available with some systems; an acoustic signal will indicate of such cases.

CHILD LOCK

Activate it by touching the CHILD LOCK key. The "key" icon will light up on the display. Touch the key again to deactivate the child lock. The icon on the display will disappear.

If the child lock is activated with no timer function engaged (only clock is displayed), then the oven will not operate.

If the child lock is activated after a timer function has been set, then the oven will operate normally; however, it will not be possible to change the settings.

When the child lock is activated, systems (cooking modes) or additional functions cannot be changed. The only possible change is to end the cooking process by rotating the selector knob to "0". Child lock will remain active after the oven is switched off. To select a new system, the child lock must first be deactivated.

OVEN LIGHTING

Oven lighting is switched on automatically when the door is opened or when the oven is switched on.

After the end of the cooking process, the light will remain on for another minute.

The light inside the oven can be switched on or off by pressing the LIGHT key.

+ **STANDBY**

Display lighting can be automatically switched off after 10 minutes if it is not used.

Press the KEY + TIMER keys to switch off the display. If a timer function has been activated, then "OFF" and the TIMER icon will appear on the display to indicate the activated function.

STEP 5: STARTING THE COOKING PROCESS

Start the cooking process by pressing the START/STOP key.



STEP 6: SWITCHING OFF THE OVEN

Turn the COOKING SYSTEM SELECTOR KNOB to position "0".

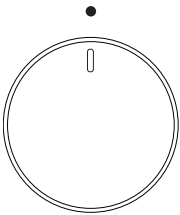

 After the end of the cooking process and after the oven has been switched off, declining temperature is displayed down to 50 °C. All timer settings are also paused and cancelled. Time of day (clock) will be displayed. After one minute of idling, the appliance will switch to standby mode.

 After the use of the oven, some water may be left in the condensate channel (underneath the door). Wipe the channel with a sponge or a cloth.

DESCRIPTIONS OF SYSTEMS (COOKING MODES) AND COOKING TABLES

If your desired food cannot be found in the cooking table, find information for similar food. The information displayed applies to cooking in a single level.

An interval of suggested temperature is indicated. Start with a lower temperature setting and increase it if you find the food is not browned sufficiently.

Cooking times are rough estimates and may vary subject to some conditions.

Only preheat the oven if required by the recipe of in the tables in this instruction manual. Heating an empty oven consumes a lot of energy. Hence, baking several types of pastry or several pizzas successively will save a lot of energy as the oven will already have been preheated.

Use dark, black silicon-layered or enamel-coated baking sheets and trays as they conduct the heat very well.

When using parchment paper, make sure it is resistant to high temperatures.

When cooking larger chunks of meat or pastry, a lot of steam will be generated inside the oven, which in turn may condense on the oven door. This is a normal phenomenon which will not affect the operation of the appliance. After the cooking process, wipe the door and the door glass dry.

Switch off the oven approximately 10 minutes before the end of the cooking process to save energy by making use of the accumulated heat

Do not cool the food in a closed oven to prevent condensation (dew).



The symbol * means that the oven should be preheated using the selected cooking system.

COOKING SYSTEMS

RAPID PREHEATING



Use this function to heat the oven to the desired temperature as quickly as possible. This mode is not appropriate for cooking.

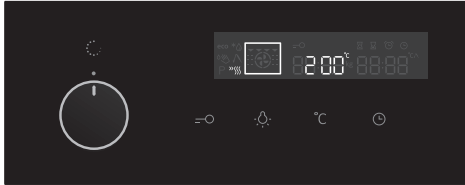

Turn the COOKING SYSTEM SELECTOR KNOB to rapid preheating. PRESET TEMPERATURE will be displayed. This temperature setting can be adjusted.

 When it is switched on, the oven will begin to heat up. The symbol °C will flash on the display. When the set temperature is reached, preheating is completed and an acoustic signal will be sounded. The acoustic signal can be stopped by pressing any key; after one minute, it will stop automatically.

UPPER AND BOTTOM HEATER

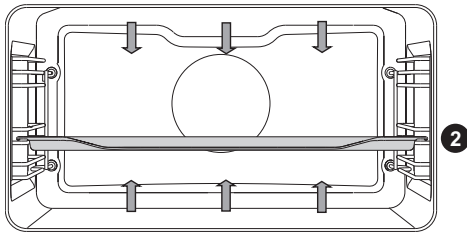

The heaters in the bottom and in the ceiling of the oven cavity will radiate heat evenly into the oven interior.

Roasting meat:

Use enamel coated, tempered glass, clay, or cast iron pan or tray. Stainless steel trays are not suitable as they strongly reflect the heat.

Type of food	Weight (g)	Guide (from the bottom)	Temperature (°C)	Cooking time (min)
MEAT				
Pork roast	1500	1	180-200	90-120
Pork shoulder	1500	1	180-200	110-140
Pork roulade	1500	2	180-200	90-110
Roast beef	1500	1	170-190	120-150
Veal roulade	1500	2	180-200	80-100
Lamb sirloin	1500	1	180-200	60-80
Rabbit loin	1000	2	180-200	50-70
Deer shank	1500	1	180-200	90-120
Meat rolls	/	2	180-200	15-30
FISH				
Braised fish	1000 g/piece	2	190-210	40-50

Baking pastry

Only use one level and dark baking sheets or trays. In light-coloured baking sheets or trays, the browning of the pastry will be poorer, as such equipment will reflect the heat. Always place the baking trays on the grid. If you are using the supplied baking sheet, remove the grid. Cooking time will be shorter if the oven is preheated.

Type of food	Guide (from the bottom)	Temperature (°C)	Cooking time (min)
PASTRY			
White bread, 1 kg *	2	220	10-15
		180-190	30-40
Buckwheat bread, 1 kg *	2	180-190	50-60
Whole grain bread, 1 kg *	2	180-190	50-60
Rye bread, 1 kg *	2	180-190	50-60
Spelt bread, 1 kg *	2	180-190	50-60
Sweet soufflé	2	170-190	40-50
Bread rolls *	2	190-210	20-30
Walnut cake	1	170-180	50-60
Sponge cake *	1	160-170	30-40
Macarons (meringue pastry)	2	130-150	15-25
Vegetable rolls	2	190-200	25-35
Fruit rolls	2	190-200	25-35
Small pastries made with yeast dough	2	200-210	20-30
Cabbage pirozhki *	2	190-200	25-35
Fruitcake	1	130-150	80-100
Meringue cookies	2	80-90	110-130
Jelly-filled rolls (Buchtel)	2	170-180	30-40

Tip	Use
Is the cake done?	<ul style="list-style-type: none"> • Pierce the cake at the top with a wooden toothpick or skewer. If there are no traces on the pick or the skewer when pulled out, the cake is done.
Did the cake collapse?	<ul style="list-style-type: none"> • Check the recipe. • Next time, use less liquid. • Note the mixing time when using small mixers, blenders etc.
The cake is too light at the bottom?	<ul style="list-style-type: none"> • Use a dark-coloured baking sheet or tray. • Place the baking sheet one guide lower and switch on the lower heater towards the end of the cooking progress.
Cake with moist stuffing is underdone?	<ul style="list-style-type: none"> • Increase temperature and extend baking time.



Do not insert the deep baking tray into the first guide.

GRILL

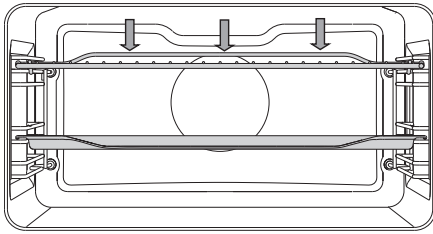

When grilling food, the upper heater and the grill heater fitted on the ceiling of the oven cavity will operate.

2 Max allowed temperature : 230°C

Preheat the infrared (grill) heater for five minutes.

Supervise the cooking process at all times. The meat may burn quickly due to high temperature.

Roasting with the grill heater is suitable for crispy and low-fat cooking of bratwurst, cuts of meat and fish (steaks, escalopes, salmon steaks or fillets etc.) or toasted bread.

When grilling directly on the grid, smear it with oil to prevent the meat from sticking onto it and insert it into the 4th guide. Insert the drip tray in to the 1st or 2nd guide. When grilling in a baking tray, make sure there is enough liquid in the tray to prevent burning. Turn the meat during cooking.

After grilling, clean the oven, the accessories, and the utensils.

Grilling table - small grill

Type of food	Weight (g)	Guide (from the bottom)	Temperature (°C)	Cooking time (min)
MEAT				
Beefsteak, rare	180 g/piece	3	230	20-25
Pork neck fillet	150 g/piece	3	230	25-30
Cutlets/chops	280 g/piece	3	230	30-35
Grill sausages	70 g/piece	3	230	20-25
TOASTED BREAD				
Toast	/	3	230	5-10
Open sandwiches	/	3	230	5-10

Grilling table - large grill

Type of food	Weight (g)	Guide (from the bottom)	Temperature (°C)	Cooking time (min)
MEAT				
Beefsteak, rare	180 g/piece	3	230	10-15
Beefsteak, well done	180 g/piece	3	230	15-20
Pork neck fillet	150 g/piece	3	230	15-20
Cutlets/chops	280 g/piece	3	230	20-25
Veal escalope	140 g/piece	3	230	15-20
Grill sausages	70 g/piece	3	230	10-20
Spam (Leberkäse)	150 g/piece	3	230	15-20
FISH				
Salmon steaks/fillets	200 g/piece	3	230	15-20
TOASTED BREAD				
6 slices of bread	/	3	230	1-4
Open sandwiches	/	3	230	2-5

When grilling in a baking tray, make sure there is enough liquid in the tray to prevent burning. Turn the meat during cooking.

When baking trout, pat the fish dry with a paper towel. Season on the inside; coat with oil on the outside and place on the grid. Do not turn the fish when grilling.



Always keep the oven door closed when using the grill (infrared) heater.

Grill heater, grid, and other oven accessories get very hot during grilling. Therefore, use oven mitts and meat tongs.

GRILL WITH FAN

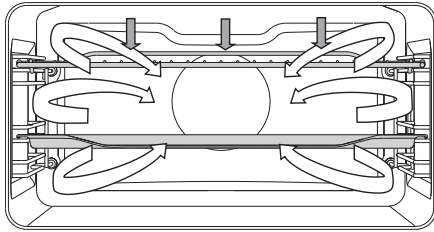

In this operating mode, the grill heater and the fan operate simultaneously. Suitable for grilling meat, fish, and vegetables.

4

2

(See descriptions and tips for GRILL)

Type of food	Weight (g)	Guide (from the bottom)	Temperature (°C)	Cooking time (min)
MEAT				
Duck	2000	1	180-200	90-110
Pork roast	1500	1	170-190	90-120
Pork shoulder	1500	1	160-180	100-130
Half of chicken	700	1	190-210	50-60
Chicken	1500	1	200-220	60-80
Meat loaf	1500	1	160-180	70-90
FISH				
Trout	200 g/piece	2	200-220	20-30



HOT AIR AND BOTTOM HEATER

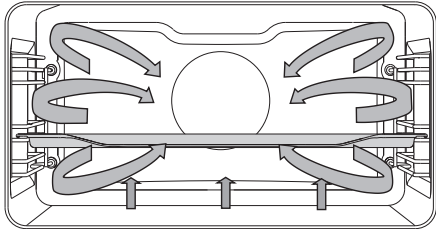

The bottom heater, the round heater, and the hot air fan will operate. Suitable for baking pizzas, apple pies, and fruitcakes.

2 (See descriptions and tips for UPPER and BOTTOM HEATER)

Type of food	Guide (from the bottom)	Temperature (°C)	Cooking time (min)
Cheesecake, short crust	2	160-170	60-70
Pizza *	2	220-230	10-15
Quiche Lorraine, shortcrust	1	200-210	50-60
Apple strudel, phyllo dough	2	180-190	50-60

Roasting with a meat probe (depending on the model)



In this mode, set the desired temperature of the food core. The oven operates until the food core reaches the set temperature. Temperature core is measured by the temperature probe.

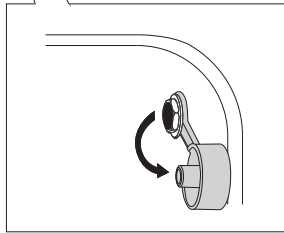
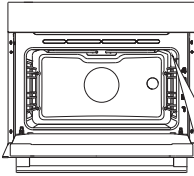

1 Remove the metal cap (the socket is in the front upper corner of the oven right wall).

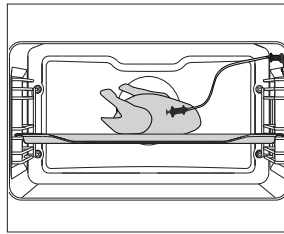

2 Connect the meat probe plug to the socket and stick the probe into the food. (If any timer settings were activated, they will be cancelled.)

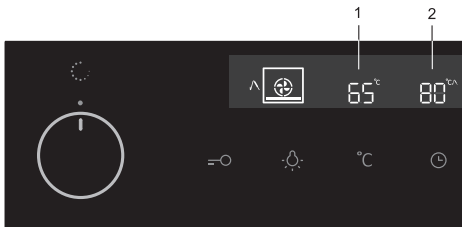

3 Turn the COOKING SYSTEM SELECTOR KNOB (hot air and lower heater). The symbol, oven cavity set temperature and meat probe set temperature will appear on the display unit. Press the START key.

- 1 Oven cavity temperature
- 2 Meat probe temperature



Current oven cavity temperature and current meat probe temperature will be displayed during operation. The temperature may be adjusted during operation. When the set core temperature is reached, the cooking process will stop. An acoustic signal will be heard which you may turn off by touching any key. After one minute, the acoustic signal will be switched off automatically. Clock will appear on the display.

After the cooking process, replace the protective cap of the meat probe socket.



**Only use the probe intended for use with your oven.
Make sure the probe does not touch the heater during cooking.
After the cooking process, the probe will be very hot. Take care to prevent burning.**

HOT AIR

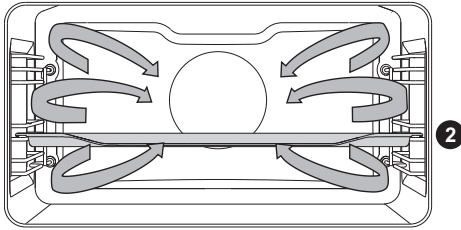

Round heater and the fan will operate. The fan installed in the back wall of the oven cavity makes sure the hot air constantly circulates around the roast or pastry.

Roasting meat:

Use enamel coated, tempered glass, clay, or cast iron pan or tray. Stainless steel trays are not suitable as they strongly reflect the heat.

Provide enough liquid during the cooking process to prevent the meat from burning. Turn the meat during roasting. The roast will remain juicier if you cover it.

Type of food	Weight (g)	Guide (from the bottom)	Temperature (°C)	Cooking time (min)
MEAT				
Pork roast, including skin	1500	1	170-190	90-120
Chicken, whole	1500	2	180-200	70-90
Duck	2000	1	170-190	120-150
Chicken breast	1000	2	190-210	50-60
Stuffed chicken	1500	1	190-210	110-130

Baking pastry

Preheating is recommended.

Biscuits and cookies can be baked in shallow baking sheets on several levels simultaneously (2nd and 3rd).

Note that baking time can differ even with if the baking sheets used are the same. The biscuits in the upper baking sheet may be ready sooner than those in the lower one.

Always place the baking trays on the grid. If you are using the supplied baking sheet, remove the grid.

For even browning, make sure the biscuits are of the same thickness.

Type of food	Guide (from the bottom)	Temperature (°C)	Cooking time (min)
PASTRY			
Sponge cake	1	160-170	30-40
Crumble cake	2	170-180	25-35
Plum cake	1	160-170	30-40
Sponge roll *	2	170-180	15-25
Fruit cake, short crust	1	170-180	50-70
Challah (braided yeast bun)	2	170-180	35-50
Apple strudel	2	180-190	50-60
Pizza *	2	210-220	15-20
Biscuits, short crust *	2	160-170	15-25
Biscuits, pressed *	2	150-160	20-30
Small cakes *	2	150-160	20-30
Cookies, leavened	2	180-190	20-35
Cookies, phyllo dough	2	180-190	20-30
Cream-filled pastry	2	190-200	25-45
FROZEN PRODUCTS			
Apple and cottage cheese strudel	2	180-190	55-70
Pizza	2	190-200	20-35
Fried potatoes, oven-ready	2	210-220	25-40
Croquettes, oven-baked	2	210-220	20-35



Do not insert the deep baking tray into the first guide.

ECO COOKING

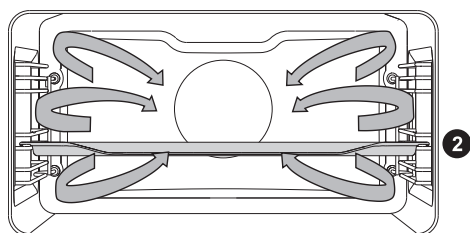

Round heater and the fan will operate. The fan installed in the back wall of the oven cavity makes sure the hot air constantly circulates around the roast or pastry.

Type of food	Guide (from the bottom)	Temperature (°C)	Cooking time (min)
MEAT			
Pork roast, 1 kg	1	200-210	110-130
Pork roast, 2 kg	1	200-210	130-150
Beef roast, 1 kg	1	210-220	100-120
FISH			
Whole fish, 200 g/piece	2	200-210	40-50
Fish fillet, 100 g/piece	2	210-220	25-35
PASTRY			
Pressed cookies	2	180-190	20-30
Small cupcakes	2	190-200	30-35
Sponge roll	2	200-210	15-25
Fruit cake, short crust	1	190-200	55-65
DISHES AU GRATIN			
Potatoes au gratin	2	190-200	40-50
Lasagne	2	200-210	45-55
FROZEN PRODUCTS			
Pommes frites, 1 kg	2	220-230	35-45
Chicken medallions, 0.7 kg	2	220-230	30-40
Fish sticks, 0.6 kg	2	220-230	30-40



Do not insert the deep baking tray into the first guide.

DEFROSTING



In this mode, the air will circulate without any heaters operating.

Only the fan will be activated. Use this function to slowly defrost frozen food (cakes, pastry, bread, rolls, and deep-frozen fruit).

By selecting the relevant symbol you may specify defrosting start and end time.

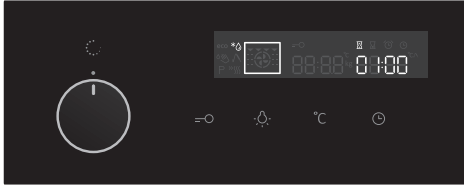

Turn the COOKING SYSTEM SELECTOR KNOB to defrosting. TIME will be displayed. This time setting can be adjusted. Press the START key.

In most cases, it is recommended to remove the food from the packaging (do not forget to remove any metal clamps or clips).

Halfway through the defrost time, the pieces should be turned over, stirred and separated if they were frozen together.

COMBINED SYSTEMS / STEAM SYSTEM

HOT AIR WITH STEAM

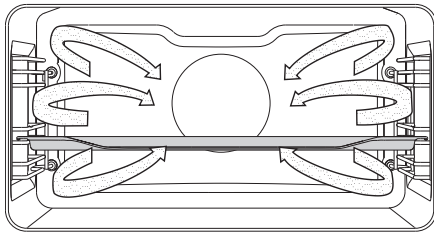

Water from the steam generator enters the oven cavity in the form of steam. In addition, round heater with fan operates to provide continuous circulation of the hot air and steam.



Fill the water tank with fresh water.

Type of food	Weight (g)	Guide (from the bottom)	Steam intensity	Temperature (°C)	Cooking time (min)
Beef/leg	1000	1	1	170-190	80-110
Beef/tenderloin	1000	1	2	180-200	50-70
Veal/leg	1000	1	1	180-200	80-110
Lamb	1000	1	1	180-200	60-90
Poultry, whole	1500	1	1	180-200	65-85
Poultry/breast	1000	2	3	180-200	50-60
Pork/fillet	1000	1	2	180-200	50-70
Fish	200 g/piece	2	2	190-210	25-35
Potatoes	1000	2	1	190-210	45-60
Potatoes with broccoli	1000	2	2	180-200	35-50

STEAM

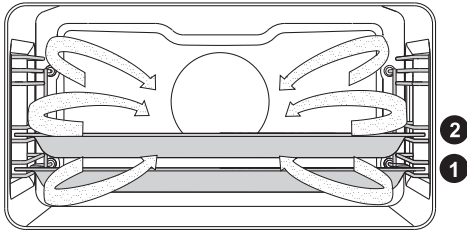

Water from the steam generator enters the oven cavity in the form of steam.

💡 Fill the water tank with fresh water.

Meat

Type of food	Weight (g)	Guide (from the bottom)	Temperature (°C)	Cooking time (min)
Sauerkraut and sausage	700	3	100	30-40
Beef steak	1000	3	100	40-50
Chicken breast	1000	3	100	20-30
Shrimps	1000	3	100	20-30
Fish fillet	500	3	80	15-20
Fish steak	500	3	80	20-25
Whole fish	400	3	100	20-30
Mussels	1000	3	100	15-20
Frankfurter sausage	1000	3	85	10-15

Vegetables

Type of food	Weight (g)	Ratio food:liquid	Guide (from the bottom)	Temperature (°C)	Cooking time (min)
String beans	500	/	3	100	50-60
Beans - seeds	500	1:2	2	100	80-90
Peas	500	/	3	100	20-25
Cauliflower - whole	500	/	3	100	20-30
Cauliflower - chopped	500	/	3	100	15-20
Broccoli - whole	500	/	3	100	15-25
Broccoli - chopped	500	/	3	100	15-20
Carrot - whole	500	/	3	100	20-30
Carrot - diced	500	/	3	100	15-25
Corn	500	/	3	100	20-30
Chickpeas	500	1:2	2	100	70-80
Fennel	500	/	3	100	15-25
Kohlrabi	500	/	3	100	20-30
Red beets - whole	500	/	3	100	50-60
Bell peppers	500	/	3	100	15-20
Radicchio	500	/	3	100	15-20
Brussels sprout	500	/	3	100	15-25
Asparagus	500	/	3	100	15-25
Spinach	500	/	3	100	5-10
Swiss chard	500	/	3	100	15-20
Mixed vegetables	1000	/	3	100	20-30
Cabbage	500	/	3	100	30-40
Chinese cabbage	500	/	3	100	25-35
Eggplant / aubergines	500	/	3	100	15-20
Courgettes	500	/	3	100	10-15
Potatoes, whole	500	/	3	100	30-40
Potatoes, sliced	500	/	3	100	25-35

Pasta/rice/cereals

Type of food	Weight (g)	Ratio food:liquid	Guide (from the bottom)	Temperature (°C)	Cooking time (min)
White rice	200	1:2	2	100	25-35
Brown rice	200	1:2	2	100	60-70
Risotto	Recipe	1:2	2	100	30-40
Pasta	200	1:2	2	100	15-25
Whole grain pasta	200	1:2	2	100	15-25
Millet	250	1:1	2	100	25-35
Gnocchi	500	/	3	100	15-25
Dumplings	500	/	3	100	15-25
Tortellini	500	/	3	100	20-30
Couscous	500	1:1	2	100	15-20
Ravioli	500	/	3	100	15-20

Desserts

Type of food	Weight (g)	Ratio food:liquid	Guide (from the bottom)	Temperature (°C)	Cooking time (min)
Melting chocolate *	200	/	2	50	20-30
Soaking/dissolving gelatin *	1 pack	/	2	50	15-20
Rice pudding	Recipe	1:4	2	100	30-40
Leavened dough	Recipe	/	2	40	25-35
Crème caramel	Recipe	/	2	100	40-50

* Cover the container with a foil

Egg dishes

Type of food	Weight (g)	Guide (from the bottom)	Temperature (°C)	Cooking time (min)
Soft-boiled eggs	200	2	100	10-15
Hard-boiled eggs	200	2	100	15-20
Poached eggs	200	2	100	13-17
Scrambled eggs	200	2	100	10-15
Omelette with bacon	Recipe	2	100	15-20

Fruit

Type of food	Weight (g)	Guide (from the bottom)	Temperature (°C)	Cooking time (min)
Apple slices	500	3	100	5-15
Apricot slices	500	3	100	5-15
Cherries	500	3	100	10-15
Gooseberries	500	3	100	5-15
Pear - chunks	500	3	100	5-15
Plums	500	3	100	5-15
Rhubarb	500	3	100	5-15
Nectarines	500	3	100	5-10

Defrosting



Type of food	Weight (g)	Guide (from the bottom)	Temperature (°C)	Defrosting time (min)
Frozen meat	500	2	50	40-50
Frozen poultry	1500	2	50	50-60
Frozen fish, 200 g / piece	1000	2	50	35-45
Frozen fruit	500	2	50	10-20
Frozen ready-made meals	1000	2	60	45-60

SOUS VIDE (STEAM COOKING)

Season the food and seal it in a plastic bag suitable for vacuum sealing and sous vide cooking. Place the sealed bag containing the food onto the perforated tray and place it on the middle oven shelf.

After the cooking process, remove the food from the bag. For a more intense flavour, the food can be quickly seared over hot oil.

Dish	Thickness (cm)	Temperature icon (°C)	Cooking time (minutes)
MEAT			
Beef steak, medium	3	60	150-180
Beef steak, well done	3	70	140-170
Pork steak, medium	3	65	70-100
Pork steak, well done	3	70	70-100
Lamb steak, medium	2	60	90-120
Lamb steak, well done	2	70	70-100
Veal steak, medium	3	60	90-120
Veal steak, well done	3	70	70-100
Boneless chicken breast	3	65	90-120
Boneless duck breast	3	65	120-150
Boneless turkey breast	3	65	180-210
Fish fillet	1	55	40-60
Fish steak	2	55	40-60
Shrimps	/	60	30-40
Octopus, tentacles	/	85	180-240
Scallops	/	60	40-60
Carrots, chopped/sliced	1	85	90-120
Potatoes, cubed	2	85	100-130
Asparagus	/	85	50-70
Eggplant / aubergines	1	85	50-70
Fruit, chunks	/	70	90-120

 To dry the inside of the oven, set hot air and lower heater  to 170 °C for 15 minutes. After the end of the programme leave the oven door open for at least two minutes to let the steam out and let the inside of the appliance become dry.

MAINTENANCE & CLEANING



Be sure to unplug the appliance from the power supply and wait for the appliance to cool down.

Children should not clean the appliance or perform maintenance tasks without proper supervision.

Aluminium finish (depending on the model)

Clean the aluminium finish with non-abrasive liquid cleaners intended for such surfaces. Apply the cleaner onto a wet cloth and clean the surface. Then, rinse the surface with water. Do not apply the cleaner directly onto the aluminium finish.

Do not use abrasive cleaners or sponges.

Note: The surface should not come into contact with oven cleaning sprays as this may result in visible and permanent damage.

Stainless steel sheet front side of the housing

(depending on the model)

Clean this surface only with a mild detergent (soapsuds) and a soft sponge that will not scratch the finish. Do not use abrasive cleaners or cleaners containing solvents as they may damage the housing finish.

Lacquer-coated surfaces and plastic parts

(depending on the model)

Clean the knobs and door handle with a soft cloth and liquid cleaners intended for smooth lacquer-coated surfaces. You may also use cleaners intended for such surfaces as instructed by the cleaner manufacturer.



The aluminium-coated surfaces should not come into contact with oven cleaning sprays as this may result in visible and permanent damage.

CONVENTIONAL OVEN CLEANING

You may use the standard cleaning procedure to clean stubborn dirt in the oven (using cleaners or an oven spray). After such cleaning, rinse the cleaner residues thoroughly.

Clean the oven and the accessories after each use to prevent the dirt from burning into the surface. The easiest way to remove fat is by using warm soapsuds while the oven is still warm.

With stubborn dirt and grime, use conventional oven cleaners. Rinse the oven thoroughly with clean water to remove all cleaner residue.

Never use aggressive cleaners, abrasive cleaners, abrasive sponges, stain and rust removers etc.

Clean the accessories (baking sheets and trays, grids etc.) with hot water and detergent.

The oven, the oven cavity and the baking trays are lined with a special enamel coating for a smooth and resistant surface. This special coating makes cleaning at room temperature easier.

USING THE STEAM CLEAN FUNCTION TO CLEAN THE OVEN

With the steam clean function and a damp cloth, you can easily remove grease and dirt from the oven walls.

Using steam clean

Only use steam clean when the oven has cooled down fully. It is more difficult to remove dirt and grease if the oven is hot.

Food particles on the enamel walls will be sufficiently soaked after program so that they can be removed with damp cloth.

Before running the "Steam clean" function, add fresh water into the water tank.

1. Select the "Steam clean" function
2. Hold the start/stop button to start steam clean

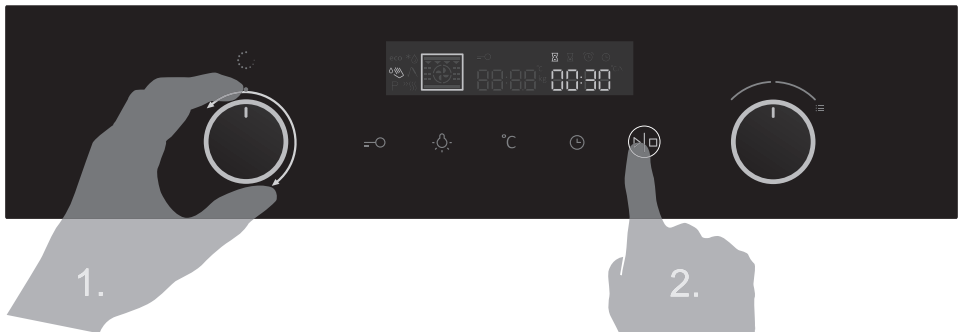

 After starting the program, wait until the time indicated on the screen expires. When the Steam Clean program is complete, wait for the oven to cool down sufficiently so that you can wipe the oven interior safely, without burning yourself.



Use the Steam Clean function after the oven has fully cooled down.

CLEANING THE STEAM SYSTEM

Cleaning depends on the water hardness level.

Water hardness	°N	Number of coloured stripes on the test strip
Soft	0-3 dH	4 green stripes / Hrd 1
Slightly hard	3-7 dH	1 red stripe / Hrd 2
Medium hard	7-14 dH	2 red stripes / Hrd 3
Hard	14-21 dH	3 red stripes / Hrd 4
Very hard	>21 dH	4 red stripes / Hrd 5

We recommend using the descaling agent as it delivers quality results of the steam system cleaning process.

After a certain volume of water has flown through the steam system, a sign **"dCal on"** will appear on the display unit when you turn the system selector dial to any steam program, indicating that the descaling program has been activated.

You may touch the START/STOP key to activated the descaling program (see page 18).



1. Add the descaling agent into the water tank.
2. Descaling procedure is in progress.
3. Descaling procedure complete. Please remove the liquid, rinse the water tank and add fresh water for the rinsing process.
4. Rinsing process complete. Clean the tank and wipe the oven.
Also clean the filter foam (see chapter CLEANING THE FILTER FOAM)

 If you do not wish to carry out the steam system descaling program at the moment, you may cancel the program by rotating the program selector dial to select **"off"**. **"dCal off"** will appear on the display unit. Confirm your selection by pressing the START/ STOP key. You may cancel the descaling program three times. After that, the system will disable the operation of the steam function.

CLEANING THE FILTER FOAM

 Any time you clean the water tank or descale the appliance, also clean the filter foam.

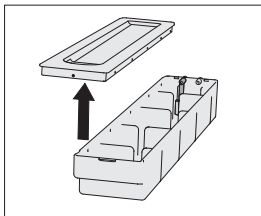
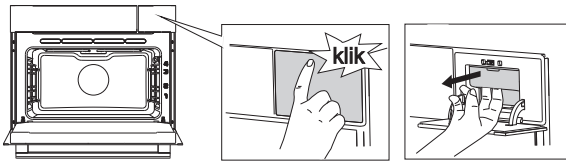

1 Open the water tank cover.

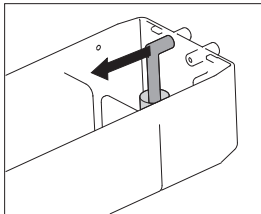

2 Remove the inlet pipe from the pipe attachment.

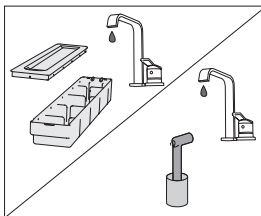

3 Clean the inlet pipe with the filter foam under running water. Rinse the foam clean so that there are no visible impurities on it. Thus, you will make sure the appliance operates correctly and preserve the fresh flavour and smell of food.

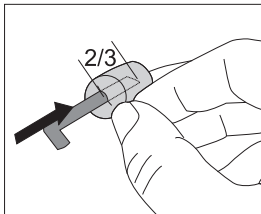

 If the filter foam is detached from the inlet pipe, replace it by inserting the pipe to the depth of two thirds of the overall foam length.

REMOVING AND CLEANING THE WIRE GUIDES

Only use conventional cleaners to clean the guides.

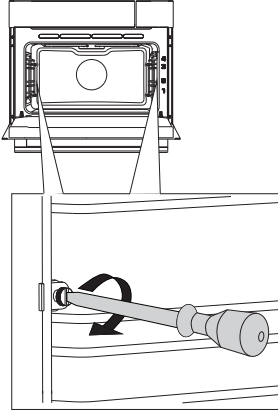

1 Undo the screw.

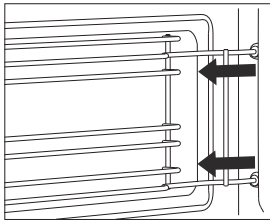

2 Remove the guides from the holes in the back wall.



After cleaning, re-tighten the screws on the guides with a screwdriver.

When replacing the wire guides, make sure you mount them on the same side they were installed on prior to removal.

REMOVING AND INSERTING THE OVEN DOOR

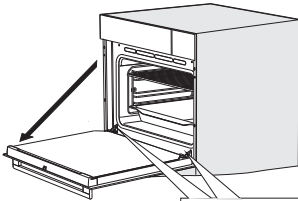

1 First, fully open the door (as far as it will go).

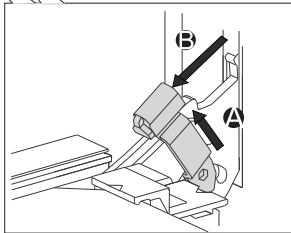

2 Slightly lift the hinge retainers and pull the door towards you.

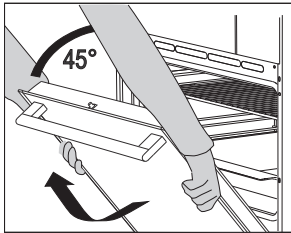

3 Slowly close the door to a 45-degree angle (relative to the position of the fully closed door); then, lift the door and pull it out.



To replace the door, observe the reverse order. If the door does not open or close properly, make sure the notches on the hinges are aligned with the hinge beds.



When replacing the door, always make sure the hinge retainers are correctly placed in the hinge beds to prevent sudden closing of the main hinge which is connected to a strong main spring. If the main spring is engaged, there is a risk of injury.

DOOR LOCK (depending on the model)

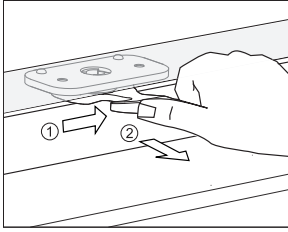

To open it, gently push it to the right with your thumb and pull the door outwards at the same time.

 **When the oven door is closed, the door lock automatically returns to the initial position.**

DEACTIVATING AND ACTIVATING THE DOOR LOCK

 **The oven should be cooled down completely.**

First, open the oven door.

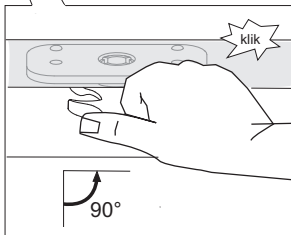
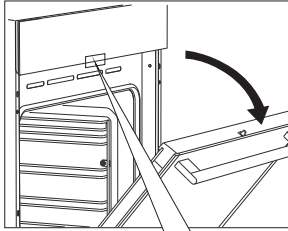

Push the door lock to the right by 90° with your thumb until you feel a click. The door lock is not deactivated.

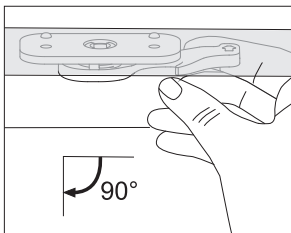

To reactivate the door lock, open the oven door and use your right-hand index finger to pull the lever towards you.

SOFT DOOR OPENING (depending on the model)

Oven door is fitted with a system that dampens the door opening force, starting at the 75-degree angle.

SOFT DOOR CLOSING (depending on the model)

Oven door is fitted with a system that dampens the door closing force, starting at the 75-degree angle. It allows simple, quiet, and smooth closing of the door. A gentle push (to a 15-degree angle relative to the closed door position) is enough for the door to close automatically and softly.



If the force applied to close the door is too strong, the effect of the system is reduced or the system will be bypassed for safety.

REMOVING AND INSERTING THE OVEN DOOR GLASS PANE

Oven door glass pane can be cleaned from the inside, but it has to be removed first. Remove the oven door (see chapter "Removing and replacing the oven door").

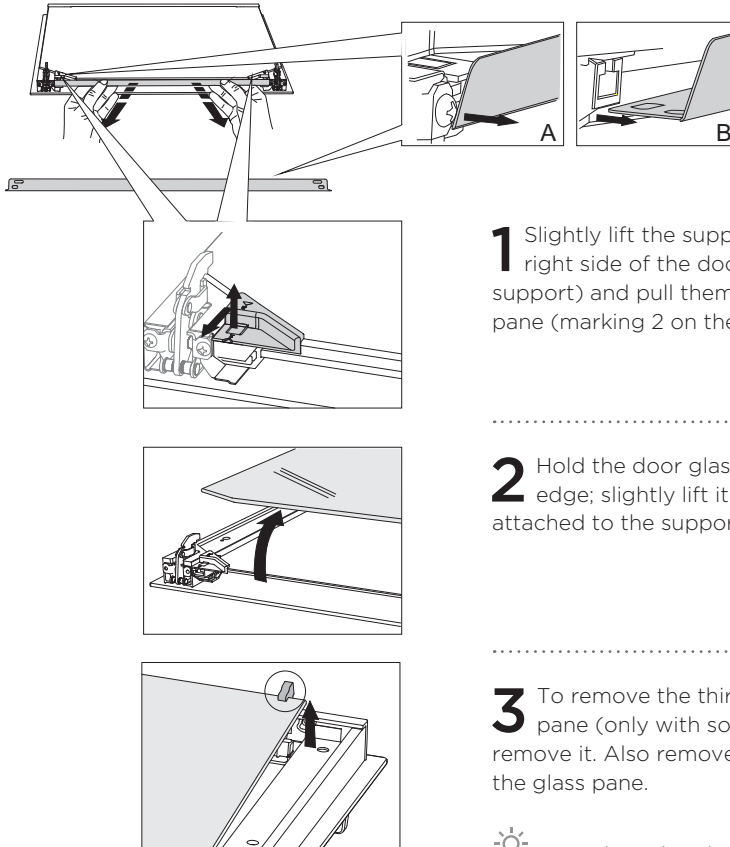

1 Slightly lift the supports on the left and right side of the door (marking 1 on the support) and pull them away from the glass pane (marking 2 on the support).

.....

2 Hold the door glass pane by the lower edge; slightly lift it so that it is no longer attached to the support; and remove it.

.....

3 To remove the third and fourth glass pane (only with some models), lift and remove it. Also remove the rubber seals on the glass pane.

 To replace the glass pane, observe the reverse order. The markings (semicircle) on the door and the glass pane should overlap.

REPLACING THE BULB

The bulb is a consumable and therefore not covered by warranty. Before changing the bulb, remove the trays, the grid, and the guides.

Use a Phillips (cross) screwdriver. (Halogen lamp: G9, 230 V, 25 W)

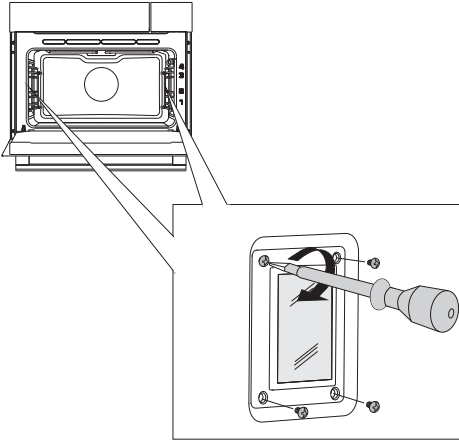

1 Use a cross screwdriver to release the bulb cover and remove it.

NOTE: Make sure not to damage the enamel.

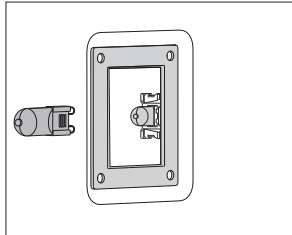

2 Remove the halogen bulb.



Use protection to avoid burns.

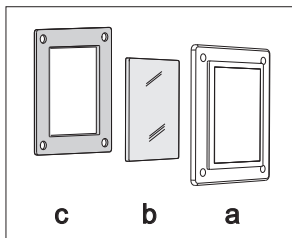

There is a gasket on the cover which should not be removed. Do not allow the gasket to be detached from the cover. The gasket should fit correctly onto the oven cavity wall.

TROUBLESHOOTING TABLE

Problem/error	Cause
There is no response of the sensors; the display is frozen.	Disconnect the appliance from the power mains for a few minutes (undo the fuse or switch off the main switch); then, reconnect the appliance and switch it on.
The main fuse in your home trips often.	Call a service technician.
The oven lighting does not work.	The process of changing the light bulb is described in the chapter. Cleaning and Maintenance.
The pastry is underdone.	Did you choose the right temperature and heating system? Is the oven door closed?
An error code is displayed (E1, E2, E3 etc.).	There is an error in the electronic module operation. Disconnect the appliance from the power mains for a few minutes. Then, reconnect it and set the time of day. If the error is still indicated, call a service technician.
Sparks appear in the oven.	Make sure all covers of the lights are fastened and that all spacers are fitted on the wire guides. Make sure the guides are correctly placed in the appliance.

If the problems persist despite observing the advice above, call an authorized service technician. Repair or any warranty claim resulting from incorrect connection or use of the appliance shall not be covered by the warranty. In this case, the user will cover the cost of repair.



Before the repair, disconnect the appliance from the power mains (by removing the fuse or by removing the plug from the wall outlet).

DISPOSAL



Packaging is made of environmentally friendly materials that can be recycled, disposed of, or destroyed without any hazard to the environment. To this end, packaging materials are labelled appropriately.

The symbol on the product or its packaging indicates that the product should not be treated as normal household waste. The product should be taken to an authorized collection center for waste electric and electronic equipment processing.

Correct disposal of the product will help prevent any negative effects on the environment and health of people which could occur in case of incorrect product removal. For detailed information on removal and processing of the product, please contact the relevant municipal body in charge of waste management, your waste disposal service, or the store where you bought the product.

We reserve the right to any changes and errors in the instructions for use.

COMBI STEAM_IL+_45



en (09-20)