

EN

DETAILED INSTRUCTIONS FOR USE OF A GAS FREE STANDING COOKER

gorenje

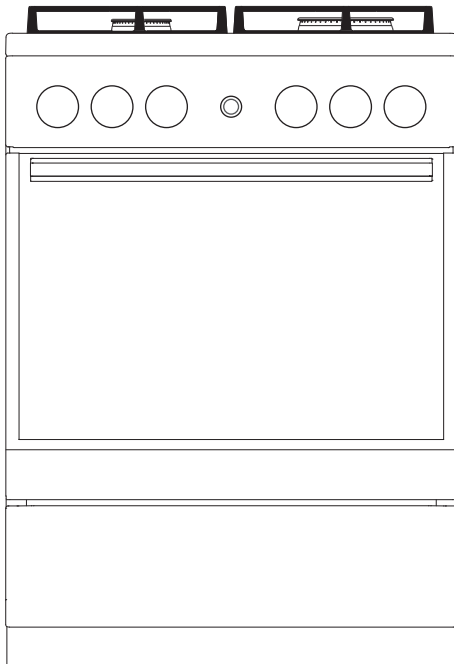

GI5121WJ
GI5121SJ

We thank you for your

trust and the purchase of our appliance.

This detailed instruction manual is supplied to make the use of this product easier. The instructions should allow you to learn about your new appliance as quickly as possible.

Make sure you have received an undamaged appliance. If you do find transport damage, please contact the seller from which you purchased the appliance, or the regional warehouse from which it was supplied.

These instructions are only valid if the country symbol is printed on the appliance. If there is NO country symbol on the appliance, please consult the technical instructions for adjusting the appliance according to the requirements for use in the relevant country.

The appliance has to be connected in compliance with the effective regulations, and it may only be used in well ventilated areas. Read the instructions before connecting or using the appliance.

Instructions for use are also available at our website:

<http://www.gorenje.com>

GORENJE gospodinjnski aparati, d.d.
Partizanska cesta 12,
SI-3320 Velenje, SLOVENIA
info@gorenje.com



Important information



Tip, note

IMPORTANT SAFETY INSTRUCTIONS



CAREFULLY READ THE INSTRUCTIONS AND SAVE THEM FOR FUTURE REFERENCE.

This appliance may only be used by children aged 8 years and above and persons with reduced physical, sensory or mental capabilities or lack of experience and knowledge if supervision or instructions are provided to them concerning use of the appliance in a safe way and if they understand the hazards involved. Do not let the children play with the appliance. Cleaning and user maintenance shall not be made by children without supervision.

WARNING: The appliance and some of its accessible parts may become very hot during use. Be careful not to touch the heating parts of the appliance. Children younger than 8 years of age shall be kept away unless continuously supervised.

WARNING: The accessible parts of the appliance may become hot during use. Young children should be kept away from the oven.

WARNING: Danger of fire: do not store items on the cooking surfaces.

CAUTION: The cooking process and a short term cooking process has to be supervised continuously.

WARNING: Unattended cooking on a hob with fat or oil can be dangerous and may result in fire. NEVER try to extinguish a fire with water, but switch off the appliance and then cover flame e.g. with a lid or a proof blanket.

WARNING: Before replacing the light bulb, make sure the appliance has been disconnected from the mains power, in order to prevent the hazard of an electric shock.

Appliance must not be installed behind a decorative door in order to avoid overheating.

Do not use harsh abrasive cleaners or sharp metal scrapers to clean the oven door glass/ the glass of hinged lids of the hob (as appropriate), since they can scratch the surface, which may result in shattering of the glass.

Do not use steam cleaners or high-pressure cleaners to clean the appliance, as this may result in an electric shock.

The appliance is not intended to be controlled by external timers or separate remote control system.

WARNING: Use only hob guards designed by the manufacturer of the cooking appliance or indicated by the manufacturer of the appliance in the instructions for use as suitable or hob guards incorporated in the appliance. The use of inappropriate guards can cause accidents.

The appliance is intended to be placed directly on the floor, without any supports or plinths.

Make sure the lid is clean and that there is no liquid spilt on it before raising it. The lid may be lacquer-coated or glass. It may only be closed when the cooking zones have completely cooled down.

CAUTION: This appliance is for cooking purposes only. It must not be used for other purposes, for example room heating.

The appliance may only be connected to the mains power by an authorized service technician or expert. Clamps (instead of connecting cable) should be protected by a clamp cover (see additional equipment). Tampering with the appliance or non-professional repair thereof may result in risk of severe injury or damage to the product.

If the supply cord is damaged, it must be replaced by the manufacturer, its service agent or similarly qualified persons in order to avoid a hazard.

Unauthorized service and repair can result in risk of explosion, electric shock, or short circuit and consequently personal injury and damage to the appliance. Such tasks may only be carried out by an authorized expert.

Prior to installation, ensure that the local distribution conditions (nature of the gas and gas pressure) and the adjustment of the appliance are compatible.

The adjustment conditions for this appliance are stated on the label (or data plate).

This appliance is not connected to a combustion products evacuation device. It shall be installed and connected in accordance with current installation regulations. Particular attention shall be given to the relevant requirements regarding ventilation.

CAUTION: The use of a gas cooking appliance results in the production of heat, moisture and products of combustion in the room in which it is installed. Ensure that the kitchen is well ventilated especially when the appliance is in use: keep natural ventilation holes open or install a mechanical ventilation device (mechanical extractor hood).



CAUTION: possibility of tilting.



WARNING: In order to prevent tipping of the appliance, stabilising means must be installed. Refer to the instructions for installation.

Prolonged intensive use of the appliance may call for additional ventilation, for example opening of a window, or more effective ventilation, for example increasing the level of mechanical ventilation where present.

This is a class 1 and 2/1 appliance. The appliance may touch the adjacent cabinets on both sides when placed in a row. On one side, a tall cabinet – taller than the appliance – may be placed at a distance of at least 10 cm from the appliance. On the other side, only a cabinet of the same height may be placed.

Pay attention to correct placement of the burner parts.

Do not install the appliance near powerful sources of heat, such as solid fuel stoves, because high temperature near them can damage the appliance.

Close the main inlet valve if you do not intend to use the burners for a longer period of time (e.g. before going on vacation).

If the power cords of other appliances located near this appliance are caught in the oven door, they may be damaged, which may in turn result in a short circuit. Therefore, keep the power cords of other appliances at a safe distance.

If you observe any faults on the gas installation or smell gas in the room:

- immediately shut off the gas supply or close the gas cylinder;
- put out any open fire and extinguish any tobacco product;
- do not switch any electrical appliance on or off (including lights);
- thoroughly ventilate the room – open the windows;
- immediately inform the service centre or an authorized natural gas distributor.

Do not line the oven walls with aluminium foil and do not place baking trays or other cookware on the oven bottom. Aluminium foil would prevent air circulation in the oven, hinder the cooking process, and ruin the enamel coating.

Oven door become very hot during operation. A third glass is installed for extra protection, reducing the temperature of the outside surface (only with some models).

Oven door hinges may be damaged when under excessive load. Do not place heavy pans on open oven door and do not lean against open oven door when cleaning the oven cavity. Never stand on the open oven door and do not let children sit on it.

Make sure the vents are never covered or obstructed in any other way.

NOTICE In case the appliance is equipped with a glass or glass ceramic cooking surface. In case of breakage:

- Immediately close the input of fuel into the burners and disconnect the electric heating elements and the appliance from the mains.
- Do not touch the surface of appliance.
- Do not use the appliance.

BEFORE CONNECTING THE APPLIANCE



Carefully read the instructions for use before connecting the appliance. Repair or any warranty claim resulting from incorrect connection or use of the appliance shall not be covered by the warranty.

APPLIANCE LID

Make sure the lid is clean and that there is no liquid spilled on it before raising it. The lid may be lacquer-coated or glass. It may only be closed when the cooking zones have completely cooled down.

Do not close the lid when the burner is lit!



The symbol on the product or its packaging indicates that glass lids may shatter when heated. Turn off all the burners before shutting the lid.

APPLIANCE DRAWER



Do not store combustible, explosive, volatile or temperature-sensitive items (such as paper, dish cloths, plastic bags, cleaners or detergents and spray cans) in the oven's storage drawer, as they can ignite during over operation and cause a fire.

OVEN EQUIPMENT AND ACCESSORIES

(depending on the model)

WIRE GUIDES

The wire guides allow preparation of the food on four levels.

Appliance operation is safe with and without tray guides.

TELESCOPIC PULL-OUT GUIDES

Telescopic pull-out guides may be fitted for the 2nd, 3rd, and 4th level. Pull-out guides can be partly or fully extendible.

EMBOSSSED

The oven has stamped side grooves in four levels for inserting of the grid and baking sheets.



The appliance and some of the accessible parts tend to heat up during cooking. Use oven mitts.

GRID



There is a safety latch on the grid. Therefore, lift the grid slightly at the front when pulling it out from the oven.

The grid or the tray should always be inserted into the groove between the two wire profiles.

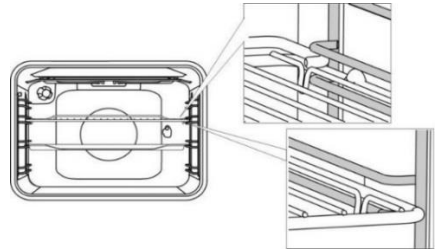

With telescopic extendible guides, first pull out the guides of one level and place the grid or the baking tray onto them. Then, push them in with your hand as far as they will go.



Close the oven door when the telescopic guides are retracted all the way into the oven.



As baking accessories heat up, their form may change. This does not affect their functionality and their original form will be restored when they cool down.

CONTROL UNIT

(depending on the model)

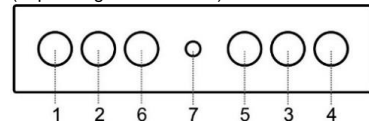

1. Cooking zone knob front left (gas burner)
2. Cooking zone knob rear left (gas burner)
3. Cooking zone knob rear right (gas burner)
4. Cooking zone knob front right (gas burner)
5. Cooking system selector knob
6. Oven lighting knob
7. Electric ignition knob

USING THE APPLIANCE

BEFORE USING THE APPLIANCE FOR THE FIRST TIME

Upon receiving the appliance, remove all parts, including any transport equipment, from the oven. Clean all accessories and utensils with warm water and regular detergent. Do not use any abrasive cleaners.

When the oven heats up for the first time, the characteristic smell of a new appliance will be emitted. Ventilate the room thoroughly during the first operation.

COOKING HOB

GAS BURNERS

- To sear the food, set the burner to maximum power first, and then continue to cook at minimum power.
- In some models, the cooker burners are fitted with thermoelectric safety devices. If the burner flame is extinguished (due to boiling over, draft etc.), gas supply will be shut off automatically. Any chance of gas leaking into the room is eliminated.

- Always place the burner cap accurately on the burner crown. Make sure the slots in the burner crown are never blocked.

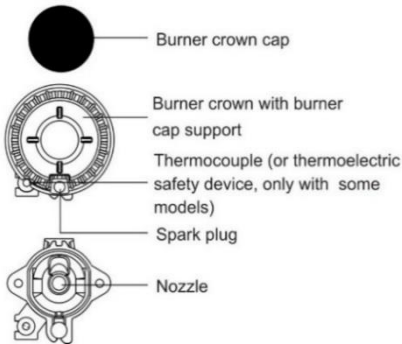

TIPS REGARDING YOUR COOKWARE

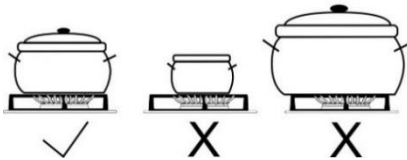

- Correct choice of cookware allows optimum cooking time and gas consumption. Cookware diameter is the most important in this respect
- If a pot or a pan is too small, the flames reaching over the edge of its bottom will damage it. Moreover, gas consumption will be higher.
- If the pot or pan is too large, there is not enough air and the burning efficiency is decreased.

Gas hob reducer (only with some models) Use the gas hob reducer when cooking in a container of smaller diameter. Place it on the grid over the auxiliary burner.

Burner type	Container diameter
Large (3,0 kW)	220-260 mm
Normal (1,9 kW)	180-220 mm
Auxiliary (1,0 kW)	120-180 mm

ENERGY SAVING TIPS

- If the cooking process allows, use a lid.
- Cookware should be suitably sized given the amount of food. When you cook a small amount of food in a large pot or pan, more energy is lost.
- If a dish takes a long time to cook, use a pressure cooker.
- Vegetables, potatoes etc. may be cooked in a smaller amount of water. The food will cook just as well, as long as the pot is tightly closed with a lid. After bringing the water to a boil, reduce the heat to a level that just suffices to maintain a slow simmer.

BURNER IGNITION AND OPERATION



Always press the knob before rotating it.

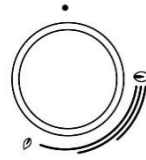

Cooking power levels are indicated on the knobs with a large and a small flame symbol. Rotate the knob over the large flame position (🔥) to the small flame position (🔥) and back. Operating range is between the two flame symbols.

Settings between (🔥) and (●) are not recommended. In this range, the flame is unstable and may be extinguished.



To turn off a burner, rotate the knob to the right to position (●).

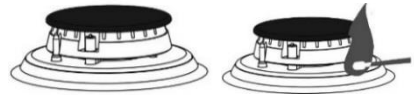

Single-handed ignition

To ignite a gas burner, press the corresponding knob and rotate it to the maximum power position. Electric spark from the spark plug will be activated and the gas will ignite.

Two-handed ignition

To ignite a gas burner, press the corresponding knob and rotate it to the maximum power position. Press the spark plug button. Electric spark from the spark plug will be activated and the gas will ignite.



Electric ignition will only work if the power cord is connected to the power mains. If electric ignition does not work due to a power supply failure or damp spark plugs, the gas can still be ignited with a match or a lighter.

After ignition, keep the knob depressed for approximately 5 more seconds until the flame is stabilized.



If the burner does not ignite in 15 seconds, close it and wait for at least 1 minute. The, repeat the ignition process.

If the flame on a burner is extinguished (regardless of the reason), close the burner and wait for 1 minute before trying to ignite it again.

OVEN

CHOOSING THE COOKING SYSTEM

(depending on the model)

Rotate the knob (left and right) to select the cooking system (see program table).

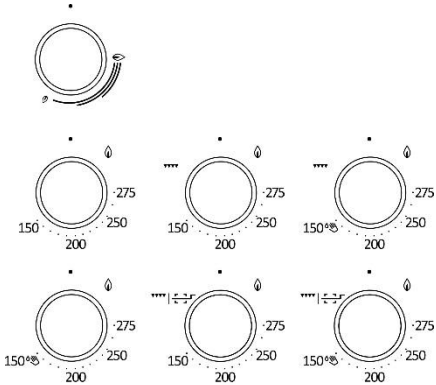

Settings can also be changed during the operation.

The gas supply to the oven burner is controlled by a tap protected with a thermoelectric flame sensor.

IGNITION OF THE OVEN BURNER

Press the knob and rotate it to the left to the maximum power position. At the same time, hold a lit match to the oven burner ignition opening until the gas is ignited.

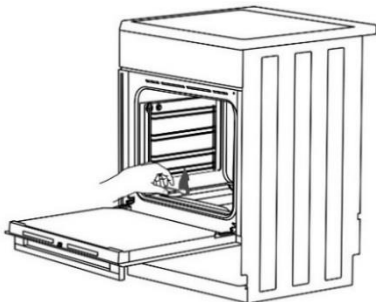

	MAXIMUM POWER	MINIMUM POWER
TAP PROTECTED		
THERMOSTAT	275°C	150°C



Single-handed ignition

To ignite a gas burner, press the corresponding knob and rotate it to the maximum power position. Electric spark from the spark plug will be activated and the gas will ignite.

Two-handed ignition

To ignite a gas burner, press the corresponding knob and rotate it to the maximum power position. Press the spark plug button.

Electric spark from the spark plug will be activated and the gas will ignite.



After ignition, keep the knob depressed for approximately 5 more seconds until the flame is stabilized.



Oven temperature is regulated by a thermostat. Immediately after ignition, the burner operates with maximum power until the set temperature is reached. Then, the thermostat automatically reduces the burner power to the level required to maintain the set temperature. Temperature regulation will only work correctly if the oven door is closed.

HEATING THE OVEN WITH THE GAS INFRARED BURNER

The heat is radiated by the infrared (grill) heater installed in the oven ceiling. It is used for grilling.

Press the knob and rotate it to the right to position **▼▼▼**. At the same time, press the ignition device knob or hold a lit match to the oven burner ignition opening until the gas is ignited.



After ignition, keep the knob depressed for 5 more seconds until the flame is stabilized.



During operation, the infrared oven heater is not temperature-controlled and it operates with full power.



When ignited grill burner oven door should be open. After 2 minutes, the oven door is closed. Grill baking then continues behind closed doors.

HEATING THE OVEN WITH THE ELECTRIC INFRARED HEATER

The heat is radiated by the infrared (grill) heater installed in the oven ceiling. It is used for grilling.

It is suitable for grilling smaller steaks, sausages, cutlets etc. It is also used for spit-roasting chicken.

Press and rotate the knob. Grilling temperature is around 240°C. When this temperature is reached, the heater is switched off and it is activated again when the temperature drops to below 240°C.

STARTING THE COOKING PROCESS

Set the cooking system; then, switch it on.

SWITCHING OFF THE OVEN

Turn the COOKING SYSTEM SELECTOR KNOB to position **●**

DESCRIPTIONS OF SYSTEMS

Heating an empty oven consumes a lot of energy. Hence, baking several types of pastry or several

pizzas successively will save a lot of energy as the oven will already have been preheated.

Use dark, black silicon-layered or enamel-coated baking sheets and trays as they conduct the heat very well.

When using parchment paper, make sure it is resistant to high temperatures.

When cooking larger chunks of meat or pastry, a lot of steam will be generated inside the oven, which in turn may condense on the oven door. This is a normal phenomenon which will not affect the operation of the appliance. After the cooking process, wipe the door and the door glass dry.

Switch off the oven approximately 10 minutes before the end of the cooking process to save energy by making use of the accumulated heat.

Do not cool the food in a closed oven to prevent condensation (dew).

Guides cooking levels

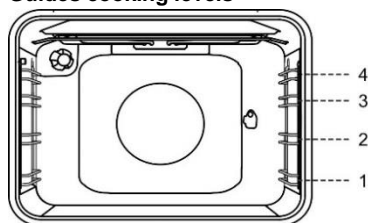

Do not insert the deep baking tray into the first guide.

The DEEP BAKING TRAY is used for roasting meat and baking moist pastry. It can also be used as a drip tray



Never place the deep baking tray in the first guide during the cooking process, except when grilling food or using the roasting spit and you are only using the deep tray as a drip tray.

BAKING PASTRY

Only use one level and light-coloured baking sheets or trays. Dark baking sheets or trays absorb too much of the heat from the oven burner.

Always place the baking trays on the grid. If you are using the supplied baking sheet, remove the grid. Cooking time will be shorter if the oven is preheated.

ROASTING MEAT

Use enamel coated, tempered glass, clay, or cast iron pan or tray. Stainless steel trays are not suitable as they strongly reflect the heat.

Provide enough liquid during the cooking process to prevent the meat from burning. Turn the meat during cooking. The roast will remain juicier if you cover it.

GRILLING WITH THE GAS-FIRED OR ELECTRIC INFRARED HEATER

Preheat the infrared (grill) heater for five minutes.

Supervise the cooking process at all times. The meat may burn quickly due to high temperature.

Roasting with the grill heater is appropriate for crispy and low-fat cooking of bratwurst, cuts of meat and fish (steaks, escalopes, salmon steaks or fillets etc.) or toasted bread.

When grilling directly on the grid, smear it with oil to prevent the meat from sticking onto it and insert it into the 3rd guide. Insert the drip tray in to the 1st or 2nd guide.

When grilling in a baking tray, make sure there is enough liquid in the tray to prevent burning. Turn the meat during cooking. Grilling with the oven door shut.

After grilling, clean the oven, the accessories, and the utensils.

Cooking with the rotisserie

(depending on the model)

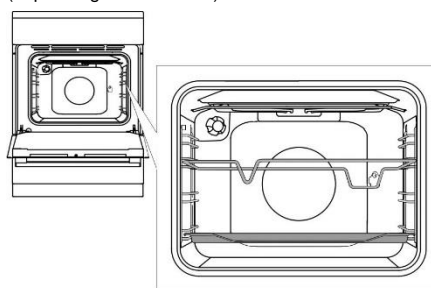

Insert the skewer support into the 3rd guide from the bottom and place the shallow baking sheet into the bottom (1st) guide to serve as a drip tray.

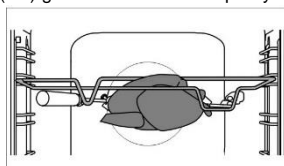

Impale the meat on the skewer and tighten the screws.

Place the skewer handle on the front skewer support and insert the tip into the opening in the right hand side of the rear oven cavity wall (the opening is protected with a rotating cover).

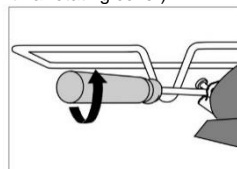

Undo the skewer handle and close the oven door.

Switch on the oven, selecting the system of electric grill heater and spit roast. 

To switch on the rotisserie with the gas grill burner, switch on the oven lighting.



The grill shall only be used when the oven door is closed.

Do not use the grill on position 4.

MAINTENANCE & CLEANING



Be sure to unplug the appliance from the power supply and wait for the appliance to cool down.

Children should not clean the appliance or perform maintenance tasks without proper supervision.

Aluminium finish (gas burner)

Clean the aluminium finish with non-abrasive liquid cleaners intended for such surfaces. Apply the cleaner onto a wet cloth and clean the surface. Then, rinse the surface with water. Do not apply the cleaner directly onto the aluminium finish. Do not use abrasive cleaners or sponges.



The aluminium-coated surfaces should not come into contact with oven cleaning sprays as this may result in visible and permanent damage.

Stainless steel sheet front side of the housing

(depending on the model)

Clean this surface only with a mild detergent (soapsuds) and a soft sponge that will not scratch the finish. Do not use abrasive cleaners or cleaners containing solvents as they may damage the housing finish.

Lacquer-coated surfaces and plastic parts

(depending on the model)

Do not clean the knobs and buttons, door handles, stickers, and rating/type plates with abrasive cleaners or abrasive cleaning materials, alcohol-based cleaners, or with alcohol. Immediately remove any stains with a soft non-abrasive cloth and some water, in order to avoid damaging the surface.

You may also use cleaners and cleaning materials intended for such surfaces as instructed by their respective manufacturers.

Enamel surfaces (oven, cooking hob)

Use a damp sponge with detergent for cleaning. Fatty stains can be removed with warm water and special detergent for enamel. Never clean enamelled surfaces with abrasive means producing irreversible damage to the appliance surface.

Glass surfaces

Do not use rough abrasive cleaning agents or sharp metal scrapes for cleaning of oven door glass, as they could crack the surface and causing the breaking of glass. Clean the glass surfaces with special means for glass, mirrors and windows.

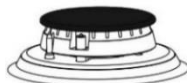

GAS BURNER

The grid, cooking surface, and burner parts may be cleaned in hot water with some washing up detergent. Do not clean them in a dishwasher.

Clean the thermocouple and the spark plug with a soft brush. These parts have to be spotlessly clean to function correctly. Clean the burner crown and cap. Make sure the slots on the burner crown are not clogged or otherwise blocked. After cleaning, thoroughly dry all the parts and reassemble them correctly. Any partly placed askew will make burner ignition harder.



Burner caps are finished in black enamel. Due to high temperatures, discoloration cannot be avoided. However, it does not affect burner operation.

OVEN

Clean the oven walls with a damp sponge and detergent. To clean stubborn stains burned into the oven wall use a special detergent for enamel. After cleaning carefully wipe the oven dry. Clean the oven only when it is completely cold. Never use abrasive agents, because they will scratch enameled surface. Wash the oven utensils with a sponge and detergent. You can also use special detergents to remove rough stains or burns.

USING THE AQUA CLEAN FUNCTION TO

CLEAN THE OVEN

Ignite the gas in the oven and rotate the system selector knob to the AQUA CLEAN position .

Pour 0,6 l water into a baking tray and place it in the lower guide.

After 30 minutes, food residues on the oven enamel walls will have softened and they will be easy to clean with a damp cloth.



Use the "AQUA CLEAN" system when the oven has fully cooled down.

CLEANING THE OVEN'S BOTTOM PANEL

Allow the bottom panel to cool down completely.

Screw out the screw in the front part of the oven, lift the bottom panel and pull it out.



Clean it with non-abrasive cleaners and mild degreasing agent. Rinse thoroughly under running

water until there are no residues of detergent on the surface left. Then, wipe it dry.

Upon reassembly, slide the tabs in the rear part of the bottom panel into the openings in the oven bottom.



If the bottom panel is not correctly placed and secured, it could affect the quality of the cooking process.

REMOVING AND CLEANING WIRE AND TELESCOPIC EXTENDIBLE GUIDES

Only use conventional cleaners to clean the guides.

Hold the guides by the bottom side and pull them towards the center of the oven cavity. Remove them from the openings at the top.



Do not clean the extendible guides in the dishwasher.

REPLACING THE BULB

The bulb is a consumable and therefore not covered by warranty. Before changing the bulb, remove the trays, the grid, and the guides.

Disconnect the appliance from the power mains!

Undo the bulb cover and pull out or undo the bulb. Halogen lamp: G9, 230 V, 25 W. (Regular bulb E14, 230 V, 25 W - depending on the model.)



Use protection to avoid burns.

COMFORT DOOR CLOSING

(depending on the model)

Cookers are equipped with new secure door hinges COMFORT. These special hinges guarantee very quiet and gentle closing of the oven door.



If the force applied to close the door is too strong, the efficiency of the system can be reduced or the system's safety can be affected.

DOOR LOCK

(depending on the model)

Open the door lock by gently pushing it to the right with your thumb while simultaneously pulling the door outwards.



When the oven door is closed, the door lock automatically returns to the initial position.

REMOVING AND REPLACING THE OVEN DOOR (depending on the model)

1. Open the oven door (up to end position).
2. Rotate the flaps of door hinges (in case of conventional closing).

At COMFORT soft closing system, rotate the flaps by 90°.

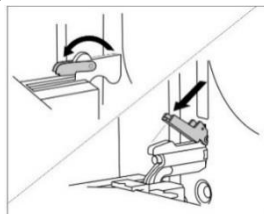

3. Slowly close the oven door until the flaps fit together with the hinges in the side laths of the door. At the angle of 15° (regarding to the closed door position), slightly close the door and pull it out from both hinges of the appliance.

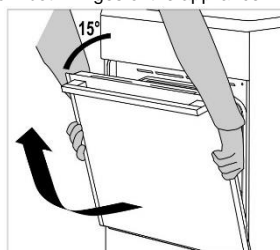

Before replacing the door, always check that the hinge flaps are correctly placed in the side laths of the door. You prevent the sudden closing of the hinge so, which is connected to a strong spring. The releasing of flap causes the damaging of door and a risk of injury.

Removing and replacing the oven door

(depending on the model)

1. Open the oven door (up to end position).
2. Raise up and turn the flaps.

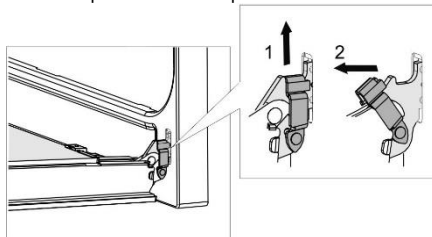

3. Slowly close the oven door, lift it slightly and pull it out from the both hinges of the appliance.

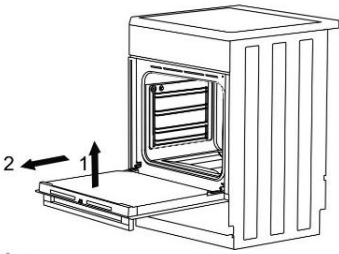

Provide these steps in reverse order at returning the door back. If the door does not open or close properly, make sure, that the hinges are correctly located on their hooks.

REMOVING AND INSERTING THE OVEN DOOR GLASS PANE (depending on the model)

Oven door glass pane can be cleaned from the inside, but it has to be removed first. Remove the oven door (see chapter "Removing and replacing the oven door").

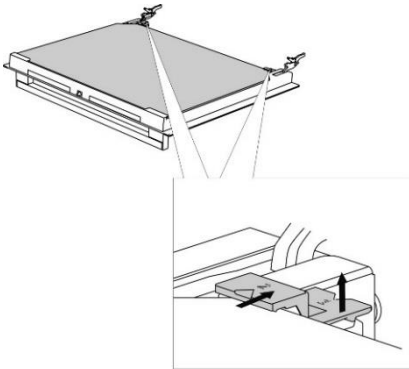

Slightly lift the supports on the left and right side of the door (marking 1 on the support) and pull them away from the glass pane (marking 2 on the support).

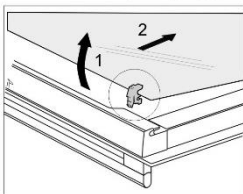
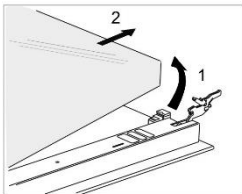

Hold the door glass pane by the lower edge; slightly lift it so that it is no longer attached to the support; and remove it.

To remove the third glass pane (only with some models), lift and remove it. Also remove the rubber seals on the glass pane.



To replace the glass pane, observe the reverse order. The markings (semicircle) on the door and the glass pane should overlap.

Removing and inserting the oven door glass pane (depending on the model)

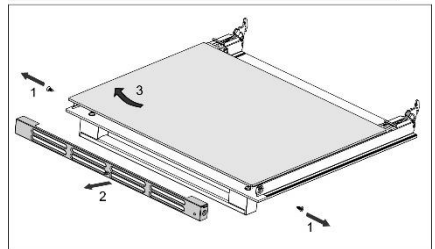
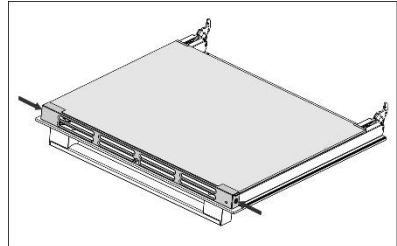

Screw out the screws on the door left and right sides and pull out the upper lath. You can pull out the glass pane of door now.



Provide these steps in reverse order at returning the glass pane back.

Repair or any warranty claim resulting from incorrect connection or use of the appliance shall not be covered by the warranty. In this case, the user will cover the cost of repair.

INSTALLATION AND CONNECTION INSTRUCTIONS

APPLIANCE PLACEMENT (mm)

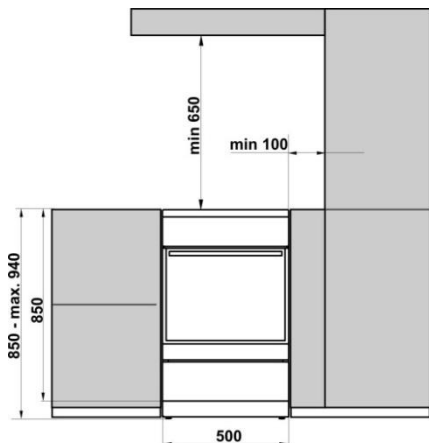

The walls or furniture adjacent to the appliance (floor, rear kitchen wall, side walls) have to be temperature-resistant to at least 90°C.

LEVELLING THE APPLIANCE AND ADDITIONAL SUPPORT

(depending on the model)

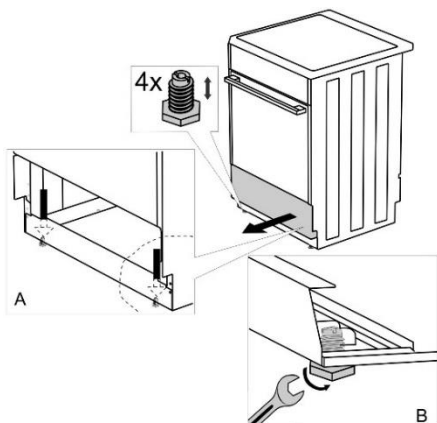

ADJUSTING THE HEIGHT OF THE COOKER

(depending on the model)

The height of the cooker is 900 mm. You can adjust the height of the appliance from 850 to 940 mm.

1. Put the cooker on the floor with back side.
2. Unscrew the screws, see arrows.

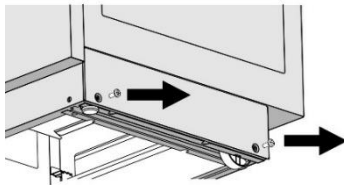

Torx T20

3. Set the desired height.
4. Screw the screws back together.

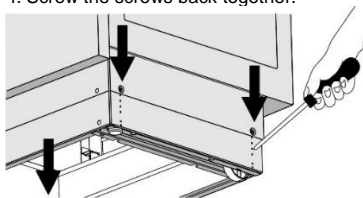

The cooker must be installed horizontally!

Follow these steps:

1. Rotate the height adjustment screws (see figure 1) to adjust the height of the cooker to the correct position.
2. Adjust the wheels (see figure 2) by screwing them with two screws at the front of the skirting board. Check the horizontal position of the stove using a spirit level.
3. Place the blind plugs into the holes in the front of the skirting board (see Figure 3).

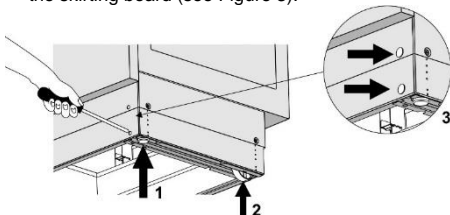

PREVENTION FROM TIPPING OVER (mm)
(depending on the model)

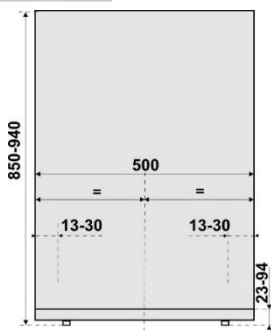
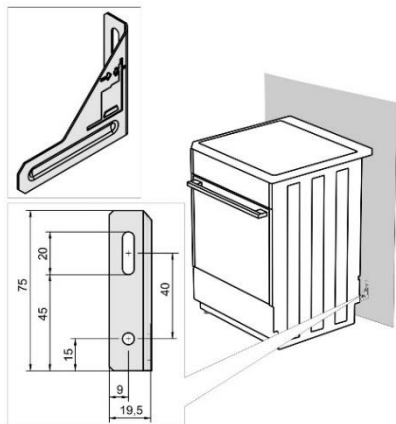

According to the plan attach the holder to the wall with the added screws and anchors. If the attached screws and anchors cannot be used, use others that will ensure a secure installation on the wall.

INSTALLATION OF THE LID
(depending on the model)

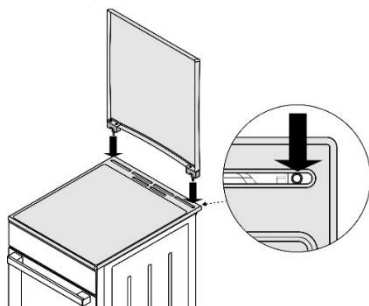

CONNECTING TO THE POWER MAINS

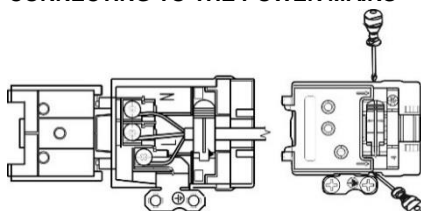

Make sure the power cord is not located near hot parts and sharp edges.

If the power cord is damaged, it should be replaced by the manufacturer or an authorized service technician, in order to avoid hazard.

CLAMP PROTECTION

The clamps should be protected by a clamp cover, see additional equipment. Electric shock danger.

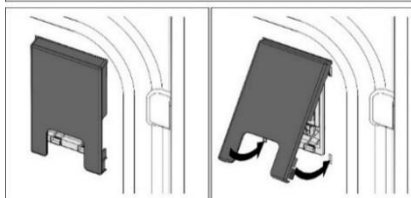
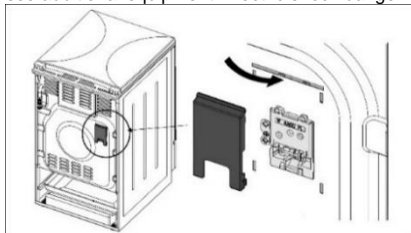

GAS CONNECTIONS

FACTORY DEFAULT SETTINGS

- Gas appliances are tested and fitted with the sign.
- Has appliances are supplied sealed with burners adjusted to natural gas type H or E (20 or 25 mbar), or to liquefied natural gas (28-30 or 37 mbar).
- The adjustment conditions for this appliance are stated on the label (or data plate).
- Before connecting the appliance, make sure the local requirements for connection (gas type and pressure) are compatible with the appliance settings.
- If the gas you are using is not compatible with the current settings on your appliance, call a service technician or the distributor.
- Modifying the hob to operate with a different type of gas requires replacement of the nozzles (see section NOZZLE TABLE).
- In case of repairs or if the seal is damaged, the functional parts have to be tested and re-sealed in compliance with the installation instructions. The functional parts include the following: fixed

nozzle for large flame and adjustable regulation screw for small flame.

CONNECTING TO GAS SUPPLY

- Appliance has to be connected to the gas mains or the gas cylinder according to the instructions of your local gas distribution company.
- There is a gas connection plug on the right-hand side of the appliance, with external thread EN ISO 228-1 or EN 10226-1 / -2 (depending on the connection regulations in the respective country).
- A liquefied natural gas connection and a non-metal gasket are also supplied. (depending on the model)
- When connecting the appliance to the gas supply, the G 1/2 or R 1/2 part has to be held to prevent it from rotating. (depending on the model)
- Use approved non-metal gaskets and approved sealants for sealing the connection joints. Only use each gasket once. The thickness of flat non-metal gaskets may be deformed by up to 25%.
- Connect the appliance to the gas supply using a certified flexible hose. The hose should not touch the upper part of the appliance.

Connection with a flexible hose

If the appliance is connected with a flexible hose, the path of the hose indicated with "A" is not acceptable. If a metal pipe is used, option "A" is permissible as well.

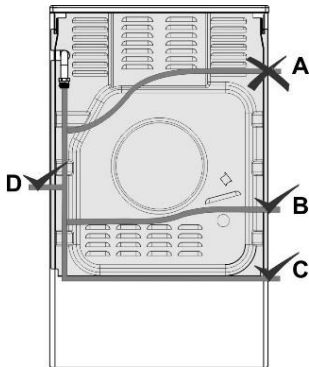

Gas connection plug

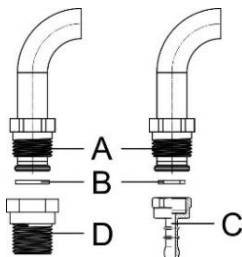

A Connection EN ISO 228-1

B Non-metal gasket, thickness 2 mm

C Hose plug for liquefied natural gas (depending on the connection regulations in the respective country)

D Connection EN 10226-1 / -2 depending on the connection regulations in the respective country).

After connection, check the operation of the burners. The flames have to burn with clearly visible blue and green core. If the flame is unstable, increase the minimum power as necessary. Explain to the user how the burners operate and review the instruction manual together.



After connecting the appliance, check the seal on all joints.

MODIFYING THE BURNERS FOR USE WITH A DIFFERENT TYPE OF GAS

- Modifying the burners for use with a different type of gas does not require removing the hob from the countertop.
- Before making the modifications, unplug the appliance from the power mains and shut off the gas supply valve.
- Replace the existing nozzle for the nominal heat load with suitable nozzles for the new type of gas (see table).
- When modifying the appliance for use with liquefied natural gas, tighten the minimum heat load regulation screw all the way to reach the minimum heat load.
- When modifying the appliance for use with natural gas, undo the minimum heat load regulation screw to reach the minimum heat load, but by no more than 1.5 turns.

After modifying the appliance for use with a different type of gas, replace the old sticker with gas type information (on the rating plate) with the relevant new sticker and test the functionality and sealing of the appliance.

Make sure the electric conductors, thermostat capillary, and thermo elements do not protrude into the gas flow area.

Adjustment elements

- Adjustment elements for minimum heat load of the burners are accessible through the openings on the control panel.
- Remove the control knobs.

Cooking burner

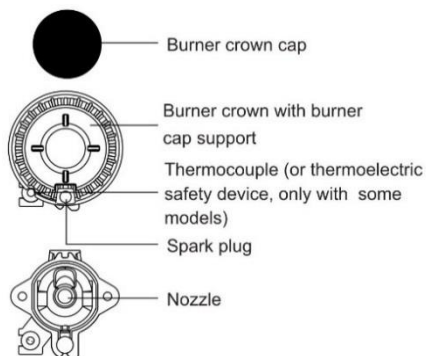

Gas valve with a safety device

B Minimum heat input regulation screw

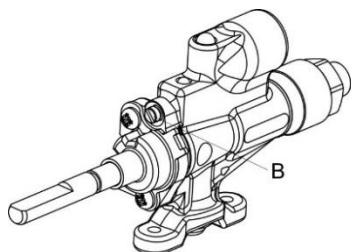

Temperature-controlled gas tap

B Minimum heat input regulation screw

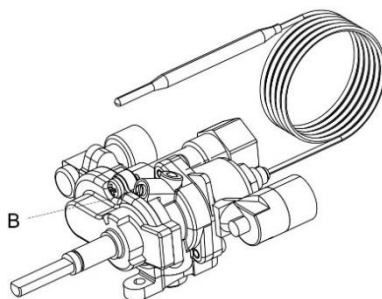

Grill burner

- 1 Nozzle
- 2 Injector holder
- 3 Grill burner

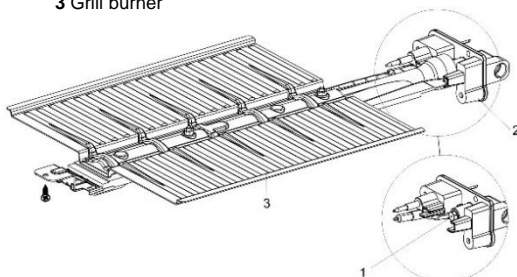

Oven burner

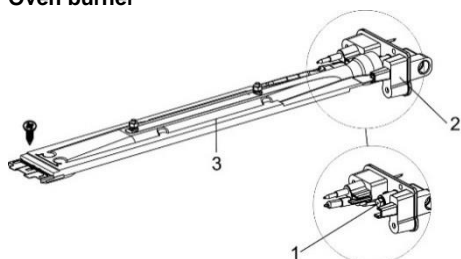

- 1 Nozzle
- 2 Injector holder
- 3 Oven burner

To access the parts required to adjust the grill burner to another type of gas, the grill burner has to be disassembled (undo the screw on the front part of the burner and pull it slightly forward).

To access the parts required to adjust the oven burner to another type of gas, the oven knob, bottom panel, and oven burner have to be disassembled (undo the screws in the front part of the burner and pull out the burner).

DISPOSAL



Packaging is made of environmentally friendly materials that can be recycled, disposed of, or destroyed without any hazard to the environment. To this end, packaging materials are labelled appropriately.

The symbol on the product or its packaging indicates that the product should not be treated as normal household waste. The product should be taken to an authorized collection center for waste electric and electronic equipment processing.

Correct disposal of the product will help prevent any negative effects on the environment and health of people which could occur in case of incorrect product removal. For detailed information on removal and processing of the product, please contact the relevant municipal body in charge of waste management, your waste disposal service, or the store where you bought the product.

Tested in compliance with the EN 60350-1 standard.

NOZZLE TABLE

Gas type, pressure		Auxiliary burner		Normal burner		
Wobbe number		Standard				
		max	min	max	min	
Natural gas H Wo=45,7+54,7 MJ/m ³ , Natural gas E, Natural gas E+ Wo=40,9+54,7 MJ/m ³ G20, p=20mbar	Nominal heat load (kW)	1,0	0,48	1,9	0,48	
	Consumption (l/h)	95,3	45,7	181,0	45,7	
	Nozzle type (1/100 mm)	72X	26	103Z	26	
	Nozzle ID	690771		568169		
Liquefied gas 3+, B/P Wo=72,9+87,3 MJ/m ³ G30, p=28-30 mbar	Nominal heat load (kW)	1,0	0,48	1,9	0,48	
	Consumption (g/h)	72,8	34,9	138,3	34,9	
	Nozzle type (1/100 mm)	50	26	68	26	
	Nozzle ID	690780		568175		
Liquefied gas 3+, B/P Wo=72,9+87,3 MJ/m ³ G31, p=37 mbar	Nominal heat load (kW)	1,0	0,48	1,9	0,48	
	Consumption (g/h)	71,5	34,3	135,8	34,3	
	Nozzle type (1/100 mm)	50	26	68	26	
	Nozzle ID	690780		568175		
Gas type, pressure		Large burner				
Wobbe number		max		min		
Natural gas H Wo=45,7+54,7 MJ/m ³ , Natural gas E, Natural gas E+ Wo=40,9+54,7 MJ/m ³ G20, p=20mbar	Nominal heat load (kW)	3,0		0,76		
	Consumption (l/h)	285,9		72,4		
	Nozzle type (1/100 mm)	130H3		33		
	Nozzle ID	574285				
Liquefied gas 3+, B/P Wo=72,9+87,3 MJ/m ³ G30, p=28-30 mbar	Nominal heat load (kW)	3,0		0,76		
	Consumption (g/h)	218,3		55,3		
	Nozzle type (1/100 mm)	86		33		
	Nozzle ID	574287				
Liquefied gas 3+, B/P Wo=72,9+87,3 MJ/m ³ G31, p=37 mbar	Nominal heat load (kW)	3,0		0,76		
	Consumption (g/h)	214,4		54,3		
	Nozzle type (1/100 mm)	86		33		
	Nozzle ID	574287				
Gas type, pressure		Oven burner (thermostat)		Oven burner (tap)		Infra burner
Wobbe number		max	min	max	min	
Natural gas H Wo=45,7+54,7 MJ/m ³ , Natural gas E, Natural gas E+ Wo=40,9+54,7 MJ/m ³ G20, p=20mbar	Nominal heat load (kW)	3,0	0,8	3,0	0,8	2,2
	Consumption (l/h)	285,6	76,2	285,6	76,2	209,6
	Nozzle type (1/100 mm)	117Y	33	117Y	33	108Y
	Nozzle ID	568171		568171		568173
Liquefied gas 3+, B/P Wo=72,9+87,3 MJ/m ³ G30, p=28-30 mbar	Nominal heat load (kW)	3,0	0,8	3,0	0,8	2,2
	Consumption (g/h)	218,3	58,2	218,3	58,2	160,1
	Nozzle type (1/100 mm)	82	33	82	33	75
	Nozzle ID	568177		568177		568178
Liquefied gas 3+, B/P Wo=72,9+87,3 MJ/m ³ G31, p=37 mbar	Nominal heat load (kW)	3,0	0,8	3,0	0,8	2,2
	Consumption (g/h)	214,4	57,0	214,4	57,0	157,2
	Nozzle type (1/100 mm)	82	33	82	33	75
	Nozzle ID	568177		568177		568178

- Regulation screws for liquefied gas are installed and set in factory to the gas type for which the factory default settings apply.
- When modifying the appliance for use with a different type of gas, the regulation screw has to be tightened or undone to set the required gas flow (do not undo the regulation screw by more than 1.5 turns).

Burner power is indicated by observing the upper Hs caloric value.



Connection to gas supply and adjustment to a different type of gas may only be carried out by an expert authorized by the gas distributor or an authorized service technician!

