

---

**INSTRUCTIONS FOR USE**

Vacuum drawer

EN

ODV8127x / VS140

ODV8128x / VS140

# Contents

<b>Pictograms used</b> .....	<b>3</b>	Vacuuming failure .....	12
<b>Safety regulations</b> .....	<b>4</b>	Starting Dry Run Function .....	13
<b>Use</b> .....	<b>9</b>	<b>Installation</b> .....	<b>14</b>
Description .....	9	<b>Safety</b> .....	14
Control panel .....	9	Install the oil filter .....	16
<b>Operation</b> .....	<b>10</b>	Built-in .....	16
Before first use .....	10	<b>Environmental aspects</b> .....	<b>18</b>
Operation .....	10	Disposal of the appliance and packaging ....	18
Vacuuming .....	11	<b>Your notes</b> .....	<b>19</b>
External vacuuming .....	12		

The following symbols are used throughout the manual, and they have the following meanings:

 INFORMATION!

**Information, advice, tip, or recommendation**

 WARNING!

**Warning – general danger**

 ELECTRIC SHOCK!

**Warning – danger of electric shock**

 HOT SURFACE!

**Warning – danger of hot surface**

 DANGER OF FIRE!

**Warning – danger of fire**

It is important that you carefully read the instructions.

# Safety regulations

 WARNING!

READ CAREFULLY AND KEEP IT FOR FUTURE REFERENCE!

## EU

 WARNING!

This appliance and the accessible parts will become hot during use. Do not touch hot parts. Keep children younger than 8 away from the appliance unless they are under continuous supervision.

- This appliance can be used by children aged from 8 years and above and persons with reduced physical, sensory or mental capabilities or lack of experience and knowledge if they have been given supervision or instruction concerning use of the appliance in a safe way and understand the hazards involved.
- Children shall not play with the appliance. Cleaning and user maintenance shall not be made by children without supervision.

## AU/NZS

 WARNING!

Accessible parts may become hot during use. Young children should be kept away.

- This appliance is not intended for use by persons (including children) with reduced physical, sensory or mental capabilities, or lack of experience and knowledge, unless they have been given supervision or instruction concerning use of the appliance by a person responsible for their safety.
- Children should be supervised to ensure that they do not play with the appliance.

## General

 ELECTRIC SHOCK!

**WARNING:** If the surface is cracked, switch off the appliance to avoid the possibility of electric shock.

- **Never use a steam cleaner for cleaning the appliance.**  
Only clean the appliance when switched off. The steam of a steam cleaner could reach the conducting parts and cause an electrical short.
- Always disconnect the appliance from the supply if it is left unattended and before assembling, disassembling or cleaning.
- A defective appliance may cause electric shock. Never switch on a defective appliance. Disconnect it and contact customer service.
- Improper installation and maintenance work or repairs are dangerous. Do not touch any conducting connections and do not change the electrical and mechanical design of the appliance. These may only be performed by authorized and trained technicians. If the appliance has a defect, please disconnect it and contact customer service.
- Do not operate the appliance with wet hands or in contact with water.
- This appliance is intended to be used in household only.
- The appliance must not be installed behind a decorative door in order to avoid overheating.
- The appliance and its accessible parts become hot during use. Care should be taken to avoid touching heating elements.

## Vacuum drawer

 HOT SURFACE!

**Danger - risk of burns!**

The sealing strip of the vacuum chamber gets very hot.

## Safety regulations

The sealing seam of the vacuum sealer bags is strongly heated during the sealing process as well. Do not touch the hot sealing strip or other accessible parts. You could suffer a burn. Watch any children and keep them away from the appliance.

 DANGER OF FIRE!

### **Danger - risk of fire!**

The sealing strip can get very hot. Do not keep highly flammable substances in the vicinity of the appliance. This poses a fire and explosion hazard due to the vapours.

 WARNING!

### **Danger - risk of injury!**

Check the appliance before each use for damage. Do not use in case of damage. Contact customer service.

In particular, check the glass lid of the appliance for even the smallest cracks and fissures. It could implode when the vacuum is connected. For this reason, the appliance must not be operated anymore when the lid is damaged. Disconnect it and contact customer service.

### **Vacuumping glassware with screw-on lids:**

- Only use glassware that is in impeccable condition. Make sure before closing the lid that the jars are not too tall. In order to avoid damaging the appliance, the distance between screw-on lid and appliance lid must be at least 1 cm.
- Never insert hoses connected to the appliance into bodily openings!

## WARNING!

### **Danger - risk of death! - Suffocation hazard!**

Keep packaging parts out of reach of children.

Foils and parts, especially small parts, may be hazardous or might be swallowed.

### **Causes of damage**

- Never pack products that might get damaged by vacuum-packing. You could get injured or might damage the appliance.
- Under vacuum conditions, fluids already start to boil at low temperatures. In the process, steam escapes and malfunctions of the appliance may result.
- Exclusively vacuum-pack cooled foods.
- Watch the vacuuming process carefully and seal the bag early if bubbles start to form. To stay on the safe side, we recommend to vacuum-pack fluids in sturdy customary vacuuming containers.
- Make sure that during the vacuuming process and during cleaning, no water gets into the interior of the appliance and the suction point of the vacuum pump. This may cause damage to the pump.
- You may use nothing but a soft, moderately damp cloth for cleaning. Never hose down your appliance with water, and do not use a steam cleaner.
- Do not misuse the appliance as a worktop, storage space, or seat. Do not put anything on the glass lid of the appliance, especially no extremely hot or cold objects. Take care that no objects fall on top of the glass lid. It could suffer damage. Close the drawer when the appliance is not in use.
- Open and close it slowly when in operation and slide it all the way in or out.
- The vacuum in the vacuuming chamber is maintained during a power outage during the vacuuming process. Do not try in any

## Safety regulations

case to open the glass lid using tools. Wait until the power has returned, and restart the vacuuming process.

- Do not use any aggressive or abrasive cleaners or sharp metal scrapers to clean the glass of the appliance's lid. Resulting scratches on the surface may damage the glass and lead to malfunction or risk of injury.
- Check the correct placement of the rubber gasket of the glass lid. Take care that the bed of the rubber gasket is clean and clear of objects. This could impair the appliance's function.

### NOTE!

Caution: Do not operate the appliance if the rubber gasket is defective. You could damage the appliance or suffer an injury. Please contact customer service.

- Do not damage the glass chamber's rubber gasket, especially not with pointy or sharp objects.
- Clean the glass lid's rubber gasket with a damp cloth and a little dish detergent.
- Do not use any sharp or aggressive detergents.
- Never vacuum-pack living goods.

### NOTE!

If you decide to discontinue using the appliance because of a fault, we recommend you cut off the cable after removing the plug from the plug socket. Take the appliance to your municipality's waste disposal site.



## Description

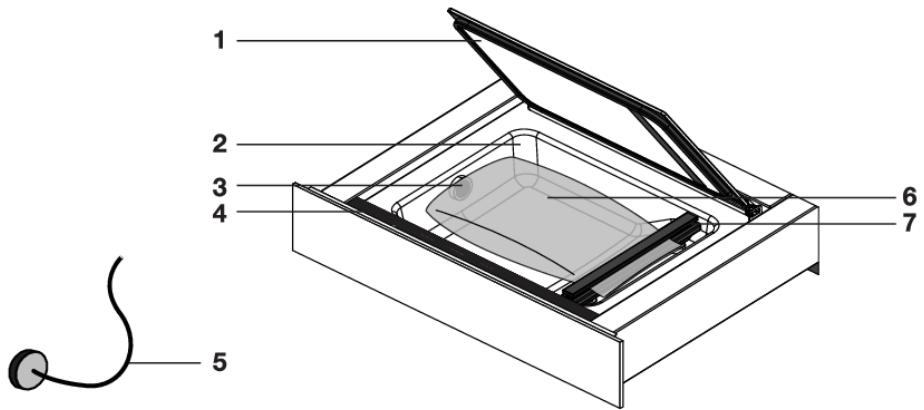

1. Lid
2. Vacuum chamber
3. Suction point
4. Control panel
5. Hose for external vacuuming
6. Vacuum sealer bag
7. Sealing strip

## Control panel

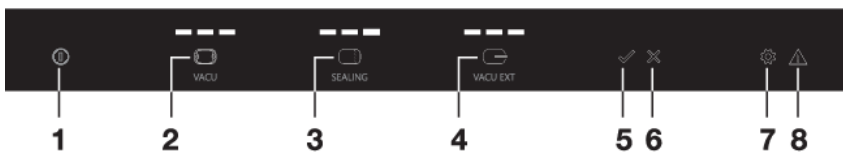

1. On/Off touch key
2. Vacuum Level touch key
3. Sealing Time touch key
4. External Vacuum Level touch key
5. Start touch key
6. Stop touch key
7. Dry Run Function touch key with indicator
8. Vacuuming Failure indicator

# Operation

## Before first use

### WARNING!

Make sure that during installation, the transport cover was removed, the oil filter was installed and that the appliance was mounted according to the installation instructions.

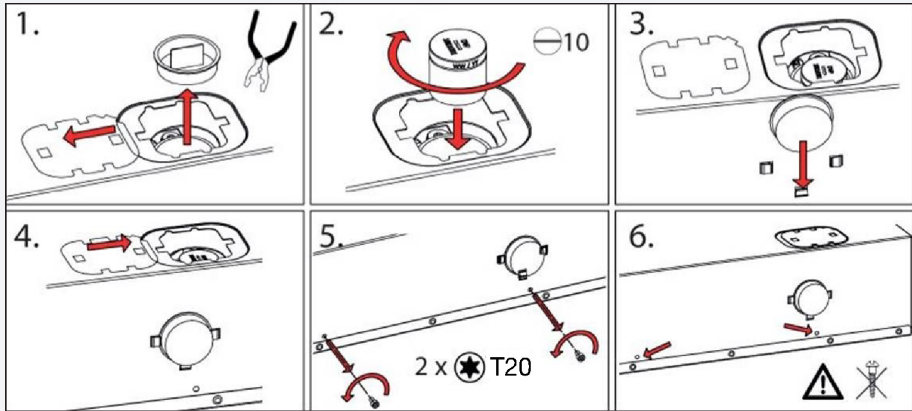

## Operation

Operate the vacuum drawer with the control panel on the top of the drawer.

1. Push the drawer in somewhat and slide it out of the cupboard.
2. Switch on the drawer with the On/Off touch key. Press the On/Off touch key until the device is switched on.
3. Open the lid and place a vacuum sealer bag in the vacuum chamber (see 'Positioning a vacuum sealer bag').
4. Close the lid.
5. Set the vacuum level with the Vacuum Level touch key (see 'Vacuuming').
  - The 3 indicator lights display the vacuum level.
  - The lights flash and diminish during vacuuming.
6. Set the vacuum closure time (sealing time) with the 'Sealing Time' touch key (see 'Vacuuming').
  - The 3 indicator lights display the sealing time.
  - The lights flash and diminish during sealing.
7. Press the Start touch key to start the vacuuming process.
8. **Immediately afterwards, shortly press on the front of the lid so that the vacuum chamber can vacuum.**

## NOTE!

Vacuumping only works if the lid on the front is quickly pushed into the rubber gasket!

- Vacuuming stops automatically if the vacuum sealer bag has been vacuumed and sealed.
- Orange indicator lights and orange lighted keys mean that a function is active.
- White indicator lights display the chosen setting and white lighted keys may be operated.

## Vacuumping

### Positioning a vacuum sealer bag

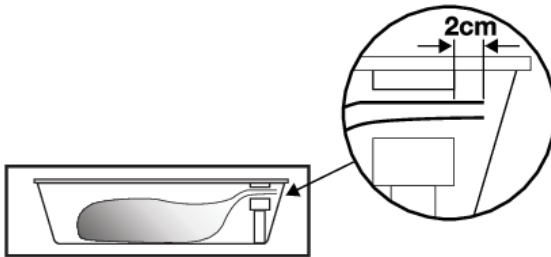

1. Open the lid and place the vacuum sealer bag with the food in the vacuum chamber.
2. Place the opening of the bag at least 2 cm outside the sealing strip.

## ⚠ WARNING!

The bag may not cover the suction point in the vacuum chamber!

### Vacuumping

Press the Vacuum Level touch key a number of times to select a vacuum level. The white indicator lights display the level.

Select from 3 vacuum levels:

- Low: for delicate products (bread, soft fruit/vegetables)
- Middle: for soft products (liquids, fish, prepared products)
- High: for firm products (firm vegetables, meat, dry products)

Press the Sealing Time touch key a number of times to select a closure time (sealing time). Select from 3 sealing times. The proper sealing time depends on the thickness of the vacuum sealer bag. The white indicator lights display the level.

Select from 3 sealing times:

# Operation

 ▷ Thin vacuum sealer bags

 ▷ Medium vacuum sealer bags

 ▷ Thick vacuum sealer bags

## External vacuuming

1. Press the On/Off touch key until the device is switched on.
2. Use the included hose to connect the external vacuuming accessory with the connection point in the vacuum chamber.
3. Use the External Vacuum Level touch key to select a low, middle or high level.
4. Press the Start touch key to start the vacuuming process. Vacuuming stops automatically when the vacuum level has been reached.

### WARNING!

Fittings to connect external vacuuming accessories to the hose for use in external vacuuming are not included with the vacuum drawer. These are dependent on the type of vacuuming accessory.

## Vacuumping failure



If the vacuum drawer cannot vacuum the vacuum chamber, this can be caused by the following issues:

- The lid is not or insufficiently pushed in when starting vacuuming.
  - *The Vacuuming Failure indicator lights up. Push the lid on the front into the rubber gasket properly.*
- The oil of the vacuum pump necessary for vacuuming contains moisture.
  - *The Vacuuming Failure indicator and the Dry Run Function indicator light up.*
  - *Start the Dry Run Function.*

### NOTE!

If the vacuuming fails a number of times, then the Vacuuming Failure indicator and the Dry Run Function indicator light up. It is then advised to perform the Dry Run Function.

- A failure has occurred.
  - *Call a service organisation.*

## WARNING!

If the Vacuum Failure indicator and Dry Run Function indicator are ignored, the drawer can no longer be operated after a certain number of warnings (except the Dry Run Function). It is then necessary to start the Dry Run Function to be able to use the drawer again.

## Starting Dry Run Function



After using the vacuum drawer for a period of time, there will be moisture in the oil of the vacuum pump. Because of this, the device may vacuum insufficiently. It is then advised to perform the Dry Run Function. If vacuuming does not work, then the Vacuuming Failure indicator and the Dry Run Function indicator light up. After a number of warnings (Vacuuming Failure indicator and Dry Run Function indicator lighting up), it is advised to perform the Dry Run Function.

1. Press the Dry Run Function touch key to start the Dry Run Function.
2. Immediately afterwards, shortly press on the front of the lid so that the vacuum chamber can vacuum.
  - *The Dry Run Function symbol flashes during drying.*

## WARNING!

- If the Dry Run Function does not completely remove the moisture from the oil after a maximum of 20 minutes, then the drawer switches to a 'cool off' setting. The vacuum drawer can then not be used for a period of one hour. The Dry Run Function indicator is visible in the display. After that, start the Dry Run Function again!
- **Regular use of the Dry Run Function is part of the normal operation of the vacuum drawer.**

## Safety

### General

- This appliance should only be connected by a registered installer!
- The electrical connection must comply with national and local regulations.
- The wall plug socket and plug should always be accessible.
- If the supply cord is damaged, it must be replaced by the manufacturer, its service agent or similarly qualified persons in order to avoid a hazard.
- If you want to make a fixed connection, make sure that a omnipolar switch with a contact separation of at least 3 mm is fitted in the supply cable.
- If a stationary appliance is not fitted with a supply cord and a plug, or with other means for disconnection from the supply mains having a contact separation in all poles that provide full disconnection under overvoltage category III conditions, the instructions shall state that means for disconnection must be incorporated in the fixed wiring in accordance with the wiring rules.
- **WARNING:** Never open the appliance casing. The casing may only be opened by a service technician.
- Prior to connecting the drawer, ensure that all cables in your home's electrical system are of sufficient diameter to supply the appliance properly.
- Complete all electrical connections before building in the appliance.
- Improper installation and maintenance work or repairs are dangerous. These may only be performed by authorized and trained technicians. If the appliance has a defect, please disconnect it and contact customer service.
- If the appliance is mounted behind a furniture front (e.g. a door), never close it while the appliance is in use. Heat and humidity accumulate behind a closed furniture front. This may damage drawer, cupboard and floor.

- Only use original replacement parts. These meet the required safety specifications.
- Please note that the appliance must not be mounted tilted or upended. The design of the appliance includes an oil-containing pump. Please refer to the installation instructions.
- **If the safety instructions and warnings are not followed, the manufacturer cannot be held responsible for any resulting damage.**

## Connection

### Electrical connection

- This appliance is manufactured in Class I; this means the device must be grounded.
- Check whether the power of the electrical mains corresponds to the power on the identification plate on the appliance.
- Before connecting to the electrical mains, check whether the power socket is grounded.
- The device is equipped with a plug. When installing the appliance, remember that this plug must remain accessible.

### WARNING!

If you want to make a fixed connection, ensure that an omnipolar switch with a contact separation of at least 3 mm is fitted in the supply line.

# Installation

## Install the oil filter

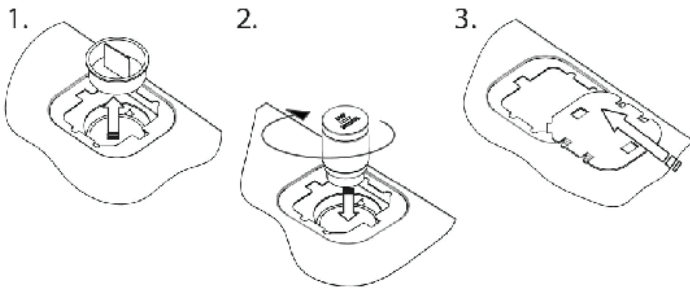

1. Remove the transport cover.
2. Install the oil filter.

## Built-in

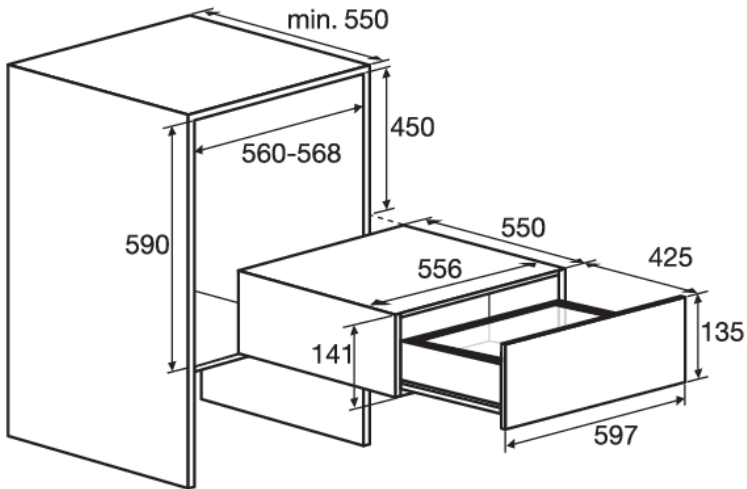

1. Put the plug of the device in a grounded wall socket.
2. Slide the appliance in the kitchen cupboard aperture. Check whether the casing fits correctly.
3. Screw the drawer securely to the cupboard at the left and right front using the 4 screws supplied.





4. Slide the decorative strips over the draw profiles on the left and right, starting from the top (VD1674M only).

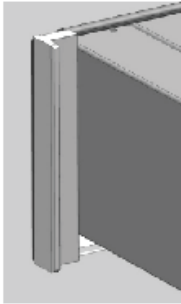
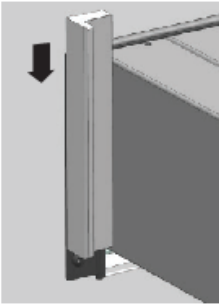

## WARNING!

When sliding out the drawer, it can tip forward if it is not securely screwed to the kitchen cupboard.

# Environmental aspects

## Disposal of the appliance and packaging

Sustainable materials have been used during the manufacture of this appliance. This appliance must be disposed of responsibly at the end of its service life. Ask your local authorities for more information about how to do this.

The appliance packaging is recyclable. The following may have been used:

- cardboard;
- polyethylene film (PE);
- CFC-free polystyrene (PS rigid foam).

Dispose of these materials in a responsible manner and in accordance with government regulations.

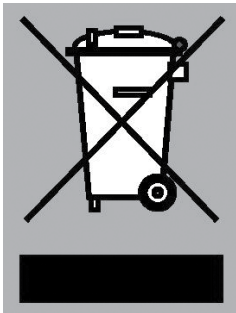

The product has been marked with a crossed-out dustbin symbol to remind you of the obligation to dispose of electrical household appliances separately. This means that the appliance may not be included with normal domestic refuse at the end of its service life. The appliance must be taken to a special municipal centre for separated waste collection or to a dealer providing this service.

A separate collection of household appliances helps to prevent any potential negative impact on the environment and on human health caused by improper disposal. It ensures that the materials of which the appliance is composed can be recovered to obtain significant savings in energy and raw materials.

## NOTE!

Please note! Do not throw a broken ceramic glass plate in the glass recycling bin but take this to the Municipality's waste recycling centre.



### **Declaration of conformity**

We hereby declare that our products satisfy the applicable European directives, orders and regulations, as well as the requirements stated in the referenced standards.



[www.asko.com](http://www.asko.com)



713096-a3



*We reserve the right to make changes.*