

GB

DETAILED INSTRUCTIONS FOR USE OF UPRIGHT REFRIGERATOR AND FREEZER

gorenje

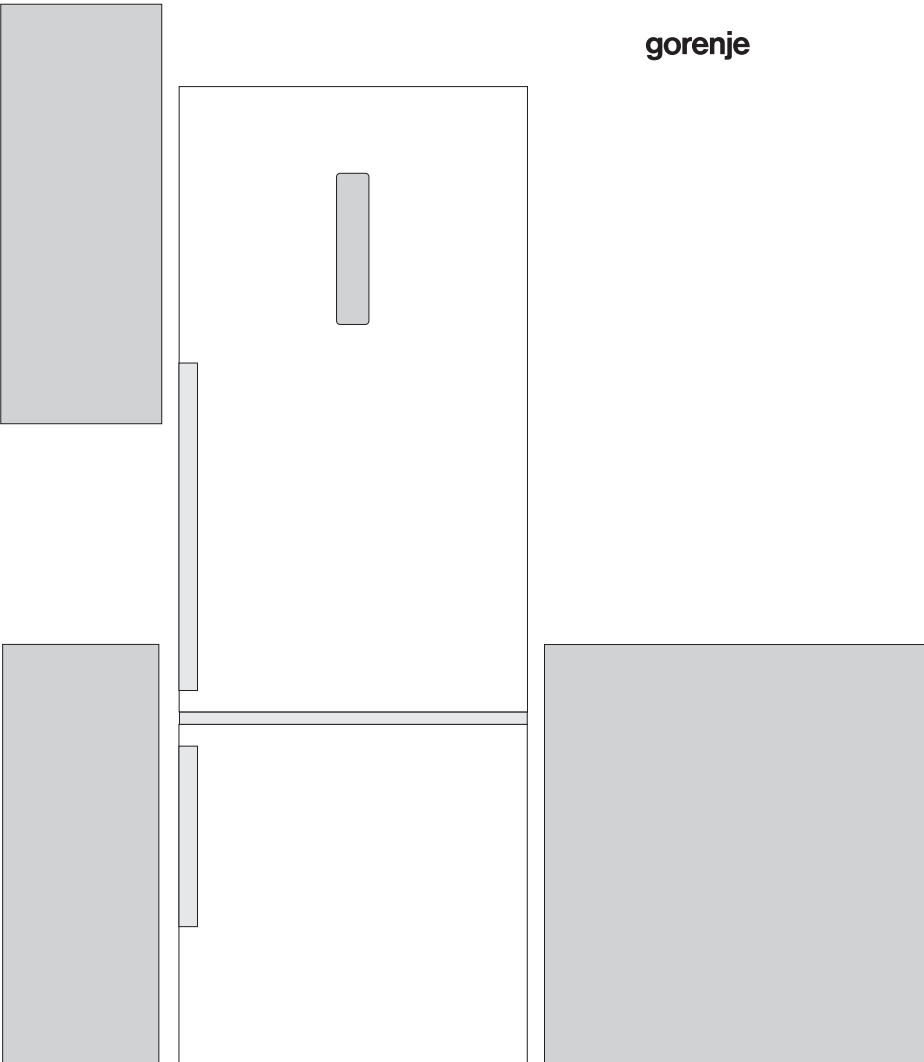

We thank you for the confidence you have shown by purchasing our appliance. We wish you find a lot of pleasure in its use.

The appliance is intended solely for household use.

Refrigerator freezer (hereinafter: the appliance) consists of two parts: the upper part is the refrigerator and the lower part is the freezer.

The refrigerator is intended for storing fresh food at temperatures above 0°C.

The freezer is intended for freezing fresh food and for long-term storage of frozen food (up to one year, depending on the type of food).

TABLE OF CONTENTS

4 IMPORTANT NOTES AND WARNINGS	INTRODUCTION
7 ADVICE FOR SAVING POWER WITH REFRIGERATION APPLIANCES	
8 APPLIANCE DESCRIPTION	APPLIANCE DESCRIPTION
9 INSTALLATION AND CONNECTION	
12 CHANGING THE DIRECTION OF DOOR OPENING	
14 OPERATING THE APPLIANCE	
25 APPLIANCE INTERIOR EQUIPMENT	
30 RECOMMENDED DISTRIBUTION OF FOOD IN THE APPLIANCE	
31 STORING FOOD IN THE REFRIGERATOR	STORING AND FREEZING FOOD
32 STORING FOOD IN THE FRESHACTIVE DRAWER	
33 STORING FOOD IN THE ZEROZONE DRAWER	
34 STORING FOOD IN THE ZEROZONE COMPARTMENT	
36 FREEZING AND STORING FROZEN FOOD	
36 Freezing process	
37 Important warnings on freezing fresh food	
37 Storage of industrially frozen food	
38 Frozen food storage time	
38 Defrosting frozen food	
39 DEFROSTING THE APPLIANCE	DEFROSTING AND CLEANING THE APPLIANCE
40 CLEANING THE APPLIANCE	
41 TROUBLESHOOTING	OTHER
43 INFORMATION ABOUT APPLIANCE NOISE	

IMPORTANT NOTES AND WARNINGS



This appliance can be used by children aged from 8 years and above and persons with reduced physical, sensory or mental capabilities or lack of experience and knowledge if they have been given supervision or instruction concerning use of the appliance in a safe way and understand the hazards involved. Children shall not play with the appliance. Cleaning and user maintenance shall not be made by children without supervision.

Before connecting the appliance to the power mains, please read carefully the instructions for use which describe the appliance and its correct and safe use. The instructions apply for several appliance types/models; thus, settings or equipment may be described herein which is not available in your appliance. The instruction manual includes the NO FROST version/model of the freezer which is fitted with a fan and in which the defrosting process is automatic.

Remove the packaging intended for protecting the appliance or particular parts during transport.

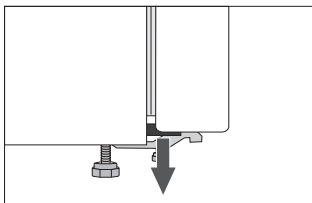

Spacers are fitted on the corners of the doors. Remove them and insert the supplied plugs into their slots (only in some models).

Before connecting the appliance to the power mains, let the appliance rest in a vertical position for approximately 2 hours. This will reduce the possibility of operation faults due to the effect of transport on the cooling system.

The appliance must be connected to the power mains and grounded in compliance with the effective standards and regulations.

The appliance may not be used outdoors and it may not be exposed to rain.

Do not store explosive substances such as aerosol cans with a flammable propellant in this appliance.

Before cleaning the appliance, unplug the appliance from the power mains (unplug the power cord from the wall outlet).

If the power cord is damaged, it must be replaced by a service technician or other adequately trained person.

If the appliance will be out of use for a prolonged period of time, switch it off using the relevant button, and unplug the appliance from the power mains. Empty the appliance, defrost it, clean it, and leave the door ajar.

If LED lighting does not work, call a service technician. Do not attempt a repair of the LED lighting yourself, as there is danger of contact with high voltage!

If the VitaLED lighting does not work, call a service technician.

To protect the environment, take the obsolete appliance to an authorized home appliance collection center.

Packaging is made of environmentally friendly materials that can be recycled, disposed of, or destroyed without any hazard to the environment.

Rating plate can be found in the appliance interior. If the language on the rating plate is not the language of your choice or the language of your country, replace it with the one supplied.

WARNING! Keep ventilation openings, in the appliance enclosure or in the built-in structure, clear of obstruction.

WARNING! Do not use mechanical devices or other means to accelerate the defrosting process, other than those recommended by the manufacturer.

WARNING! Do not damage the refrigerant circuit.

WARNING! Do not use electrical appliances inside the food storage compartments of the appliance, unless they are of the type recommended by the manufacturer.



The symbol on the product or its packaging indicates that the product should not be treated as normal household waste. The product should be taken to an authorized collection center for waste electric and electronic equipment processing. Correct disposal of the product will help prevent any negative effects on the environment and health of people which could occur in case of incorrect product removal. For detailed information on removal and processing of the product, please contact the relevant municipal body in charge of waste management, your waste disposal service, or the store where you bought the product.

ADVICE FOR SAVING POWER WITH REFRIGERATION APPLIANCES

- Install the appliance as specified in the instruction manual.
- Do not open the door more often than necessary.
- Occasionally make sure air circulation underneath the appliance is unobstructed.
- Condenser unit on the rear wall should be kept clean (see chapter Cleaning the appliance).
- If the gasket is damaged or does not provide a perfect seal for other reasons, have it replaced as soon as possible.
- Store the food in tightly sealed containers or appropriate packaging.
- Before placing the food in the appliance, cool it to room temperature.
- Defrost frozen food in the refrigerator compartment.
- Remove the drawers from the freezer compartment as described in the instruction manual, in order to make use of the entire interior.
- Defrost your conventional freezer when an approximately 3-5 millimeter layer of frost or ice has built up on the refrigerated surfaces.
- Make sure the layout of shelves in the compartment is uniform and that the food is placed so that the air can freely circulate in the appliance interior (observe the recommended placement of food as described in the instructions).
- In appliances with a fan, do not block the fan slots.
- If you do not need the fan or the ionizer, switch them off to reduce power consumption.

APPLIANCE DESCRIPTION

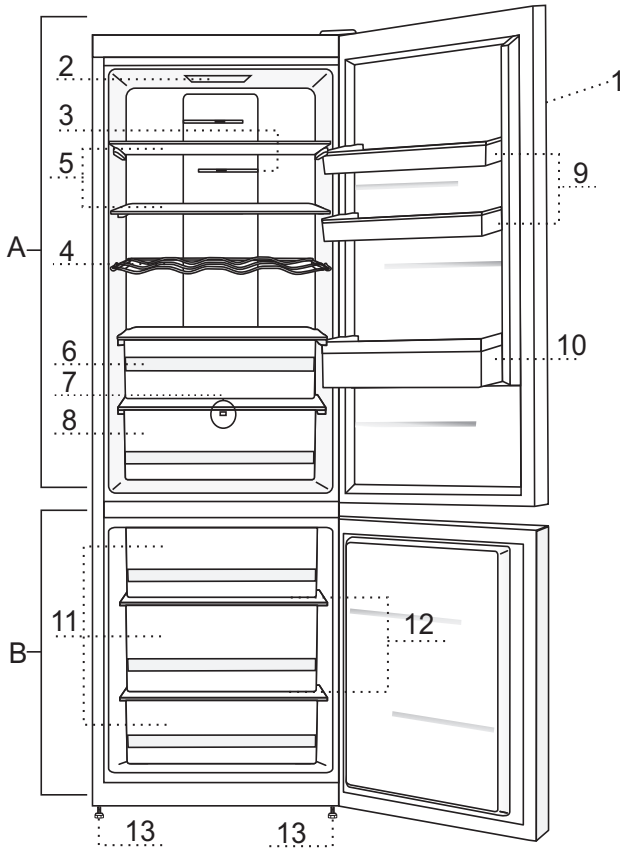

A Refrigerator

- 1 Control unit
- 2 Led lighting of refrigerator interior
- 3 IonAir air ionizer (+ on/off switch)
- 4 Bottle rack
- 5 Pull-out glass shelf (height adjustable)
- 6 FreshActive/ZeroZone drawer*
- 7 VitalLED light*
- 8 CrispActive/CrispZone fruit and vegetables drawer with humidity control
- 9 SimpleSlide height-adjustable door bin
- 10 Bottle bin

B Freezer / ZeroZone**

- 11 Freezer drawers / ZeroZone area
- 12 Glass shelves
- 13 Foot*

- Appliance interior equipment may change according to the appliance model.
- The drawers are protected against pulling out. To remove a drawer from the appliance, open it, then lift the front part and pull it out.

** Freezer/ZeroZone is an adjustable area that can be used either as a freezing compartment or a ZeroZone. When the appliance is switched on for the first time, this compartment will function as a freezer.

* Only in some models

INSTALLATION AND CONNECTION

SELECTING THE ROOM

- Install the appliance in a dry and well ventilated room. The appliance will operate correctly if the environment temperature is in the interval specified in the table. The appliance class is indicated on the rating plate / label with the basic information on the appliance.

Class	Temperature
SN (subnormal)	from +10°C to +32°C
N (normal)	from +16°C to +32°C
ST (subtropical)	from +16°C to +38°C
T (tropical)	from +16°C to +43°C

Warning: Make sure the room where the appliance is installed is large enough. There should be at least 1 m³ of space per 8 grams of refrigerant. Amount of refrigerant is stated on the rating plate in the appliance interior.

INSTALLING THE APPLIANCE

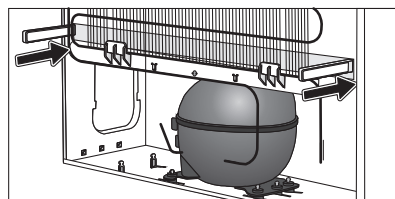
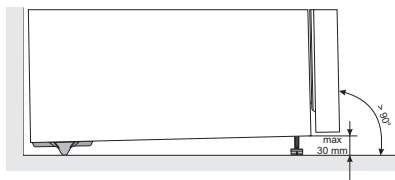

Appliance installation should be carried out by at least two persons to avoid any physical injury or damage to the appliance.

- The appliance must stand level or tilted slightly to the back, stable on a solid base. At the front, the appliance is fitted with two adjustable legs that can be used to level the appliance. At the rear side, casters allow for easier installation of the appliance (only with some models).
- There should be a clearance of at least 5 cm between the appliance and any cupboard installed above it, in order to allow adequate cooling of the condenser unit.
- The appliance is supplied with two spacers which should be installed on the lower part of the housing to prevent from pushing the appliance too close to the wall. Appliance may also be installed without the spacers; however, this may increase power consumption.
- Do not expose the appliance to direct sunlight and do not place it near any source of heat. If this cannot be avoided, install an insulation panel.

- The appliance may stand alone or it may be placed ext to a cupboard or a wall. Consider the clearance required to fully open the door in order to allow pulling out the drawers and shelves (see installation diagram).

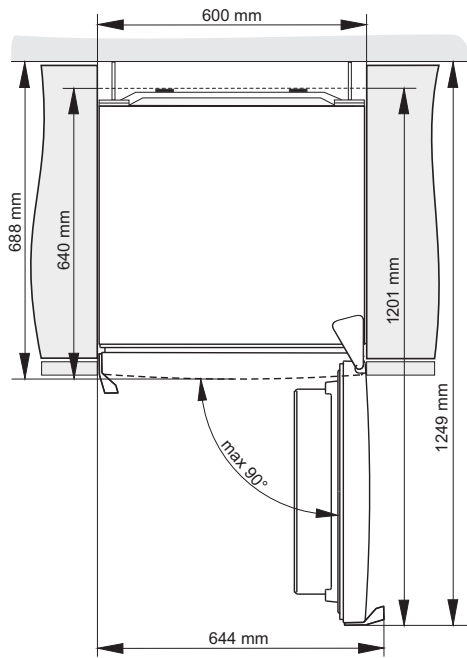

Note: When placing the appliances side by side, the anti-dew (anti-condensation) set has to be purchased and installed!

Code for ordering the set:

Dry room (relative humidity below 60%)	Appliances with a height of 1850 mm	Appliances with a height of 2000 mm
METAL PLATE (INOX)	576604	576606
PLASTIC PLATE		
WHITE	672114	672118
GREY	672115	672117
BLACK	672116	672120
Humid room (relative humidity over 60%)*	Appliances with a height of 1850 mm	Appliances with a height of 2000 mm
METAL PLATE (INOX)	558776*	558855*

*** For safety reasons, the appliance should only be installed by an authorized service technician!**

CONNECTING THE APPLIANCE

- Connect the appliance to the power mains using a connection cable. The wall outlet should be fitted with a ground contact (safety socket). Nominal voltage and frequency are indicated on the rating plate/label with basic information on the appliance.
- The appliance must be connected to the power mains and grounded in compliance with the effective standards and regulations. The appliance will withstand short-term deviations from the nominal voltage, but not more than +/- 6%.

CHANGING THE DIRECTION OF DOOR OPENING

Tools required: socket wrench No. 8, Phillips screwdriver, torx 25, flat screwdriver

The procedure to change the direction of door opening should be carried out by at least two persons.

1. Remove the upper hinge cover (A) and the cover from the connector (B1).
2. Unplug the connector (C), unscrew the upper hinge (D) and remove the upper door (E).
3. Remove the side panels (F) and (G), then unscrew and remove the middle panel (H).
4. Move the upper hinge (A) and the connector and cable to the opposite side. Replace all three panels (F), (G), and (H). Make sure the cable runs through the grooves in the panels like it did before disassembly.
5. Then remove the covering plugs (I), unscrew the mid hinge (J) and remove the lower door (K) from the lower hinge (L).
6. Tilt the appliance backwards, undo the lower hinge (L) and the foot (M) and install them on the opposite side. Make sure the washer is installed like it was before disassembly.
7. Move the door bearings (N) and retainers (S) to the opposite side.
8. Place the Mid hinge (J) on the lower door (K) and place the lower door on the lower hinge (L). Fasten the mid hinge (the door should be open while you do this). Do not forget to place the washers (O) and covering plugs (I) as they were placed before the disassembly.
9. Place the upper door (E) on the middle hinge (J). Remove the covering plugs (P) and (B2). Reconnect the connector (C) and fasten the upper hinge.
10. Install the over of the upper hinge (A), connector cap (B1), and covering caps (P) and (B2).
11. Changing the side of the handle (R): remove the plugs/caps, undo the screws and fasten the handle on the opposite side.
Place the plugs/caps on the opposite side.
Note: Step 11 (handle replacement) can be skipped on appliances with integrated handle.

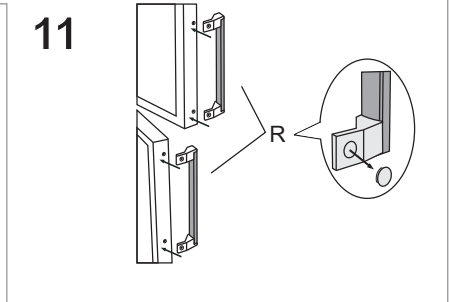
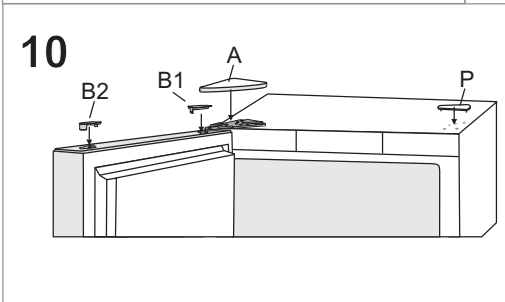
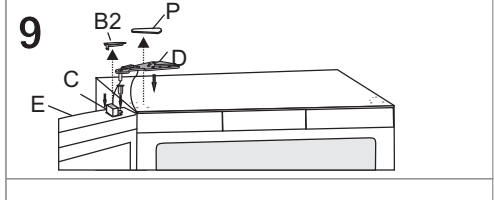
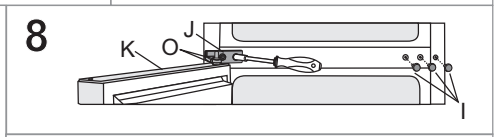
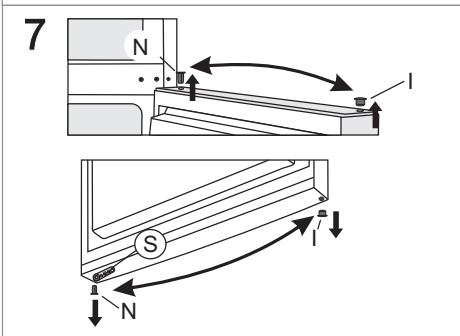
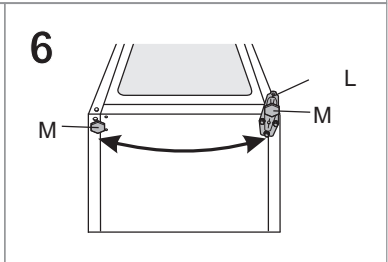
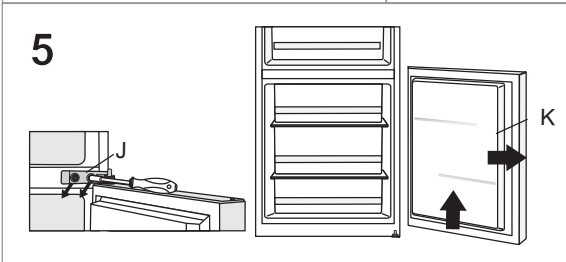
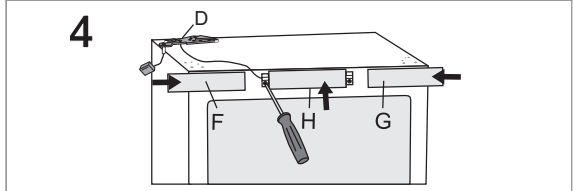
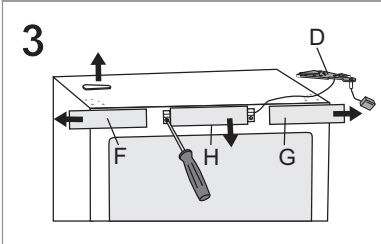
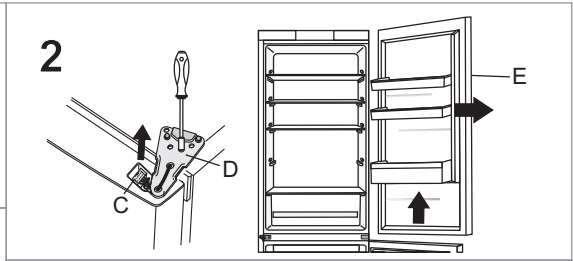
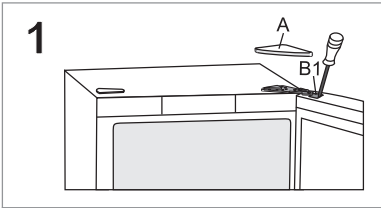

OPERATING THE APPLIANCE

CONTROL UNIT 1

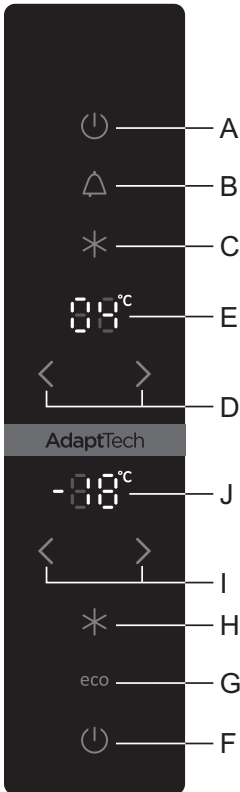

- A Appliance on key and refrigerator compartment off key
- B Acoustic alarm off key
- C Super cool on/off key
- D Refrigerator compartment temperature keys
- E Refrigerator temperature display
- F Freezer compartment on key and appliance off key
- G ECO function on/off key
- H Super freeze on/off key
- I Refrigerator compartment temperature keys
- J Freezer compartment temperature display

SWITCHING THE APPLIANCE ON/OFF

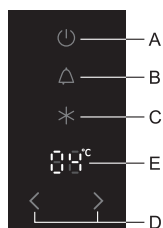

Switching the appliance on: Switch on the appliance by briefly pressing the key **A**.

With this model, it is possible to only switch on the freezer compartment while the refrigerator compartment is switched off. This setting can be made in two ways:

- briefly press the **F** key to switch on the freezer compartment only; or
- first briefly press the **A** key to switch on the entire appliance. Then, press and hold (for three seconds) the **A** key to switch off the refrigerator compartment.

When the **A** key is pressed again, the refrigerator compartment will be switched back on.

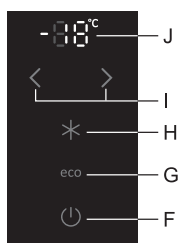

Switching off the appliance: To switch off the appliance, press and hold (for three seconds) the key **F** (caution: appliance will remain powered, i.e. there will still be electric current in the appliance).

ADJUSTING THE TEMPERATURE

- To set the temperature in the refrigerator compartment use the keys **D**:
< lower temperature ; > higher temperature.
- Temperature in the refrigerator compartment can be set from +1°C to +9°C.
- After one of the **D** keys is pressed, the most recent temperature setting will flash on the display **E**. Use the **D** keys to set the desired temperature. Three seconds after the last key was pressed, the most recent temperature setting is stored for the refrigerator compartment.
- Recommended setting is 4°C.

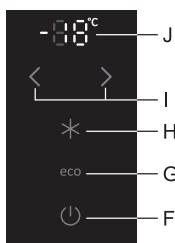

- To set the temperature in the freezer compartment use the keys **I**:
 - < lower temperature ;
 - > higher temperature.
- Temperature in the freezer compartment can be set from -24°C to -16°C.
- After one of the **I** keys is pressed, the most recent temperature setting will flash on the display **J**. Use the **I** keys to set the desired temperature. Three seconds after the last key was pressed, the most recent temperature setting is stored for the freezer compartment.
- Recommended setting is -18°C.

FREEZER BOOST FUNCTION (SUPER FREEZE)

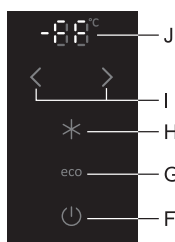

- Use this setting after switching on the appliance for the first time, before cleaning, or 24 hours before inserting a large amount of food.

Switching on the freezer boost (super freeze) function: Press the **H** key. **FF** will appear on the display **J**.

If the freezer boost is not deactivated manually, it will be automatically switched off after approximately 2 days. Then the temperature of the freezer compartment returns to the most recently set value.

EXTREME FREEZING (UPPER DRAWER OF THE FREEZER COMPARTMENT)

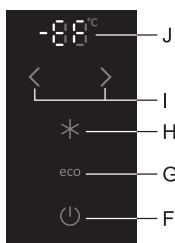

- In order to quickly freeze fresh food, use the **XtremeFreeze** function that is only active in the upper drawer of the freezer compartment. It involves intensive blowing of cool air in that part of the appliance. Faster freezing will retain more vitamins, minerals, and nutrients in the food for a longer period of time.

Switching on the freezer boost (XtremeFreeze) function: Press the **H** key and hold it for at least 3 seconds. **EF** will appear on the display **J**.

- With this setting, the compressor will operate continuously and the temperature in the freezer compartment will drop considerably.
- If the setting is not deactivated manually (by pressing the »H« key), it will be deactivated automatically after approximately one day. Freezer compartment temperature will return to the most recent setting.
- Use this setting for freezing smaller amounts of food (up to 2 kilograms) in the upper drawer. When freezing a large amount of food, the setting should be activated 12 hours before the food is placed in the freezer.

REFRIGERATOR BOOST (SUPER COOLING) (REFRIGERATOR COMPARTMENT)

- Use this setting after switching on the appliance for the first time, before cleaning, or before inserting a large amount of food.

Switching on the refrigerator boost (super cool) function: Press the **C** key.

If the function is not deactivated manually, it will be deactivated automatically after approximately six hours. Refrigerator compartment temperature will return to the most recent setting.

HIGH TEMPERATURE ALARM

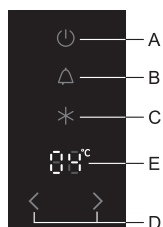

If the temperature inside the appliance is too high, acoustic alarm will be activated (**intermittent tone**) and the **B** key will flash.

- Acknowledge and turn off the acoustic alarm by pressing the **B** key.
- The acoustic alarm will be activated every 24 hours if the temperature in the appliance is not low enough and there is danger of food spoilage. The alarm will be switched off automatically as soon as the temperature in the freezer drops to a level that no longer presents spoilage hazard.

- When the appliance is switched on for the first time, there is a 24-hour delay in temperature alarm operation since the appliance will not have reached the adequate temperature. Thus, unnecessary activation of alarm is prevented.

Open refrigerator door alarm: if the refrigerator or freezer compartment door is open for more than 2 minutes, acoustic alarm will be activated and the **B** key will flash. When the door is closed, the alarm will be deactivated. It can also be switched off by pressing the **B** key.

ECO FUNCTION

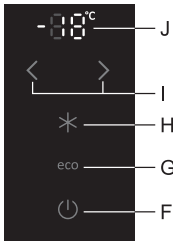

To activate the **Eco** function, press the **G** key. With this function activated, appliance will operate with optimum settings.

SAFETY BLOCK (CHILD SAFETY LOCK)

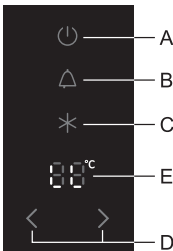

Use this function if you do not wish to manually adjust the appliance settings. To activate, press and hold the **B** key (for three seconds); **LL** will appear on the display **E**. This will lock all keys except **B**. To deactivate the safety lock, press the **B** key and hold it for three seconds.

CONTROL UNIT 2

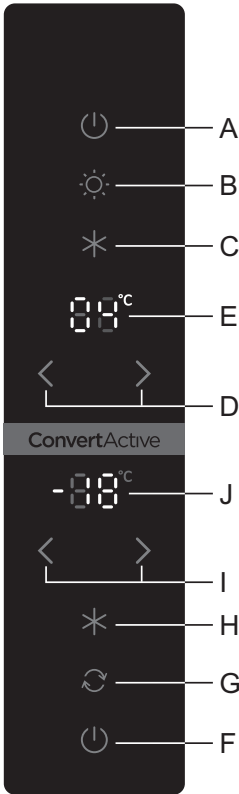

- A Appliance on key and refrigerator compartment off key
- B VitaLED light on/off key
- C Super cool on/off key
- D Refrigerator compartment temperature keys
- E Refrigerator temperature display
- F Freezer compartment on key and appliance off key
- G Freezer/ZeroZone switch key
- H Super freeze on/off key
- I Freezer compartment temperature keys**
- J Freezer compartment temperature display**

SWITCHING THE APPLIANCE ON/OFF

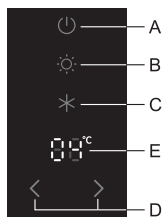

Switching the appliance on: Switch on the appliance by briefly pressing the key **A**.

With this model, it is possible to only switch on the freezer compartment while the refrigerator compartment is switched off.

This setting can be made in two ways:

- briefly press the **F** key to switch on the freezer compartment only; or
- first briefly press the **A** key to switch on the entire appliance. Then, press and hold (for three seconds) the **A** key to switch off the refrigerator compartment.

When the **A** key is pressed again, the refrigerator compartment will be switched back on.

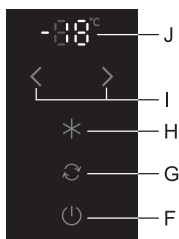

Switching off the appliance: To switch off the appliance, press and hold (for three seconds) the key **F** (caution: appliance will remain powered, i.e. there will still be electric current in the appliance).

ADJUSTING THE TEMPERATURE

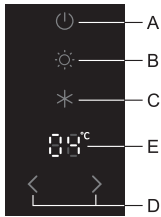

- **Refrigerator compartment:** press the **D** keys to set the **refrigerator compartment** temperature between +1°C and +9°C. Recommended setting is 4°C. When **ZeroZone** is activated, the temperature can be set between +4°C and +9°C.
- **Freezer compartment:** press the **I** keys to set the freezer compartment temperature between -24°C and -16°C. Display **J** will flash until the temperature in the freezer compartment reaches the set level. Recommended setting is -18°C.
- **ZeroZone** (see **ZeroZone** section): press the **I** keys to set the ZeroZone compartment temperature between -2°C and +3°C. Display **J** will flash until the temperature in the **ZeroZone** compartment reaches the set level.

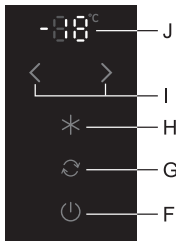

- < lower temperature ;
- > higher temperature

Temperature display **E** or **J** will flash while the temperature settings are adjusted. The most recent setting is automatically saved after 3 seconds.

VITALED FUNCTION

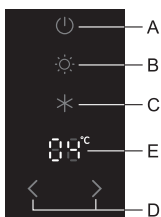

VitaLED: press the **B** key to switch the VitaLED on or off. When the VitaLED is switched on, the **B** key will be lit up. When the VitaLED function is activated, the orange LED lighting in the fruit and vegetable bin will be switched on. In case of a power outage, the VitaLED function will not remain activated. VitaLED prolongs the freshness of food and allows it to retain the flavour and the nutrients. Use it only when necessary as it increases power consumption.

REFRIGERATOR BOOST (SUPER COOLING) (REFRIGERATOR COMPARTMENT)

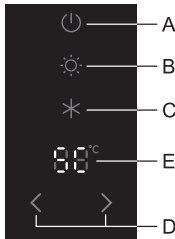

- Use this setting after switching on the appliance for the first time, before cleaning, or before inserting a large amount of food.

Switching on the refrigerator boost (super cool) function: Press the **C** key.

The sign **SC** will appear on the display unit **E**. If the function is not deactivated manually, it will be deactivated automatically after approximately six hours. Refrigerator compartment temperature will return to the most recent setting.

FREEZER BOOST FUNCTION (SUPER FREEZE)

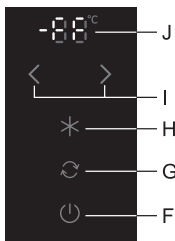

- Use this setting after switching on the appliance for the first time, before cleaning, or 24 hours before inserting a large amount of food.

Switching on the freezer boost (super freeze) function: Press the **H** key. **FF** will appear on the display **J**.

If the freezer boost is not deactivated manually, it will be automatically switched off after approximately 2 days. Then the temperature of the freezer compartment returns to the most recently set value.

**** If the bottom compartment functions as a ZeroZone, the key H does not have any function.**

EXTREME FREEZING (UPPER DRAWER OF THE FREEZER COMPARTMENT)

- In order to quickly freeze fresh food, use the **XtremeFreeze** function that is only active in the upper drawer of the freezer compartment. It involves intensive blowing of cool air in that part of the appliance. Faster freezing will retain more vitamins, minerals, and nutrients in the food for a longer period of time.

Switching on the freezer boost (XtremeFreeze) function: Press the **H** key and hold it for at least 3 seconds. **EF** will appear on the display **J**.

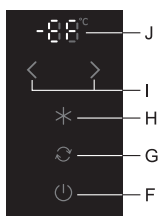

- With this setting, the compressor will operate continuously and the temperature in the freezer compartment will drop considerably.
- If the setting is not deactivated manually (by pressing the »H« key), it will be deactivated automatically after approximately one day. Freezer compartment temperature will return to the most recent setting.
- Use this setting for freezing smaller amounts of food (up to 2 kilograms) in the upper drawer. When freezing a large amount of food, the setting should be activated 12 hours before the food is placed in the freezer.

HIGH TEMPERATURE ALARM

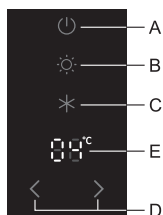

If the temperature inside the appliance is too high, acoustic alarm will be activated (**intermittent tone**) and the temperature display will flash.

- Deactivate the acoustic alarm by opening and closing the door.
- The acoustic alarm will be activated every 24 hours if the temperature in the appliance is not low enough and there is danger of food spoilage. The alarm will be switched off automatically as soon as the temperature in the freezer drops to a level that no longer presents spoilage hazard.

- When the appliance is switched on for the first time, there is a 24-hour delay in temperature alarm operation since the appliance will not have reached the adequate temperature. Thus, unnecessary activation of alarm is prevented.

Open door alarm: if the refrigerator or freezer compartment door is open for more than two minutes, an acoustic alarm will be activated. When the door is closed, the alarm will be deactivated.

SAFETY BLOCK (CHILD SAFETY LOCK)

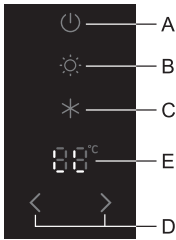

Use this function if you do not wish to manually adjust the appliance settings. To activate, press and hold the **B** key (for three seconds); **LL** will appear on the display **E**.

This will lock all keys except **B**.

To deactivate the safety lock, press the **B** key and hold it for three seconds.

SAFETY BLOCK (CHILD SAFETY LOCK)

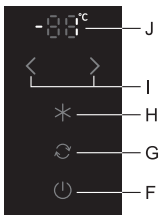

- The entire freezer compartment can be turned into a **ZeroZone**. The temperature in this compartment is around 0°C or slightly below this point. Therefore, do not store food that is sensitive to low temperature in this compartment as such food may freeze.

Before switching to ZeroZone function, empty the freezer compartment to prevent the frozen food from defrosting and perishing.

- **Switching the ZeroZone on/off:** press the **G** key and hold it for 5 seconds. When activated, the **G** key will be lit up.
- **Temperature setting in the ZeroZone:** press the **I** keys to set the temperature between -2°C and +3°C.
- **ZeroZone may operate even when the refrigerator compartment is switched off.**

After switching from freezer to **ZeroZone** function, it may be necessary to wait a few hours for the temperature to increase to the set value. The display **J** will flash during this time.

- The temperatures are approximate and they depend on the temperature settings in the refrigerator compartment, environment temperature, frequency of door opening, and amount of food inserted. Higher temperatures in the ZeroZone compartment lead to higher temperatures in the refrigerator compartment, and vice versa. Adjust the setting to the operating conditions.
- If the bottom compartment functions as a **ZeroZone**, the temperatures in the refrigerator compartment can only be set in the range from +4°C to +9°C. We recommend such use only when environment temperature is between +16°C and +32°C. At higher temperatures, it is not possible to guarantee adequately low temperatures in the appliance.

APPLIANCE INTERIOR EQUIPMENT

(* Equipment depends on the model)

SHELF

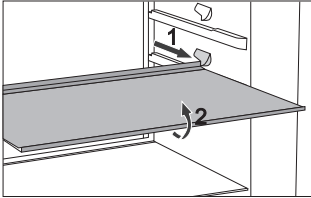

- For easier access to food and clarity, the shelves can be partly pulled out.
- The shelves may be adjusted to suit your preferences using the guides in the refrigerator interior. To remove a shelf from the refrigerator, pull it out to the point when it is stopped by the guide. Then, lift it slightly at the front part and pull it all the way out. Store perishables at the back of the shelf where the temperature is the lowest.

WIRE BOTTLE RACK

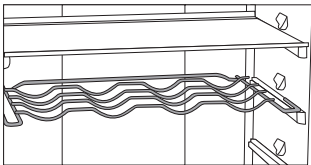

- Some models also feature a wire bottle holder. The bottle holder is protected against being inadvertently pulled out; it can only be pulled out when it is empty. To pull it out, lift it slightly at the back and pull it towards you. Place the bottle holder so that the length of the bottles does not prevent proper closing of the door. The holder can take a maximum load of 9 0.75-liter bottles or 13 kilograms of total weight – see label on the right side in the appliance interior.
- Cans may also be placed on the bottle rack (lengthwise or crosswise).

CRISPACTIVE FRUIT AND VEGETABLES DRAWER WITH HUMIDITY CONTROL *

- The CrispActive bin is intended for storing fruit and vegetables. When the VitaLED function is activated, this bin is lit with a special orange light of similar wavelength as that of the sun. Therefore, photosynthesis and synthesis of vitamin C continue to take place in the vegetables and the fruit. As a result, the food retains its freshness, colour, flavour, nutrients etc.
- The bin has integrated humidity regulator which allows setting the humidity according to the amount of food stored.

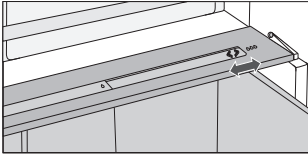

Smaller amounts of food - push the control slider to the right;

Larger amounts of food - push the control slider to the left;

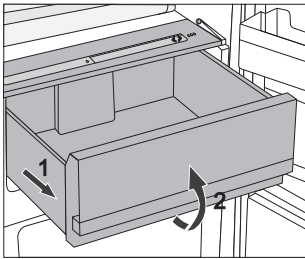

- Pulling out the bin:
 - Pull out the bin as far as it will go.
Then, lift the front part and pull it out completely.

CRISPZONE - FRUIT AND VEGETABLE BIN WITH HUMIDITY CONTROL*

- The bin at the bottom of the refrigerator is intended for storing fruit and vegetables. It provides humidity and prevents the food from drying out.
- Store the food in suitable packaging to prevent them from emitting or taking on odours. The bin has integrated humidity regulator which allows setting the humidity according to the amount of food stored.

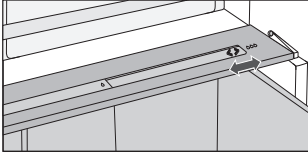

Smaller amounts of food - push the control slider to the right;

Larger amounts of food - push the control slider to the left;

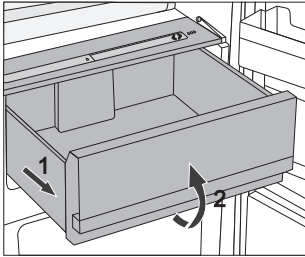

- Pulling out the bin:
 - Pull out the bin as far as it will go. Then, lift the front part and pull it out completely.

INTERIOR SIDE OF THE REFRIGERATOR DOOR

ounted on the refrigerator door are compartments (shelves or bins) intended fro storing cheese, butter, eggs, yoghurt and other smaller packages, tubes, cans, etc. There is a bottle shelf at the lower end of the door.

ADJUSTABLE DOOR BINS

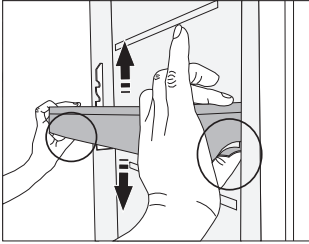

The height of the door bins can be adjusted without having to remove the bins from the appliance. Simply pull the two levers on each side of the bin towards you and slide the bin up or down.

To remove a bin from the appliance, lift it as far as it will go and pull it out.

STORAGE BIN (MULTIBOX)*

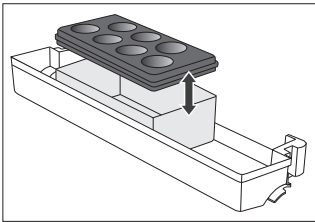

- **MultiBox** bin offers a convenient way for storing food with a strong or pungent smell, e.g. ripened or blue-vein cheese, sausages, onions, butter etc.
- The silicone lid provides an air-tight seal that prevents the food from drying out and the odour to spread throughout the refrigerator compartment.
- The silicon lid can also be used as an egg or ice tray.

- If the flexible lid is used as an egg tray, place it directly on the bottom of the door bin and use the open lower part of the Multibox bin to store food in smaller packages – pâté, jams, smaller tubes etc.

FAN

- The fan, hidden in the freezer unit, will make sure the temperature is distributed more evenly and reduce condensation (dew) on the storage surfaces.

IONIZER (IONAIR)

- **Air ionizer** placed in the refrigerator compartment removes most bacteria, viruses, gases, and unpleasant odours to make sure the air in the refrigerator is always fresh. The food will remain fresh and tasty longer.

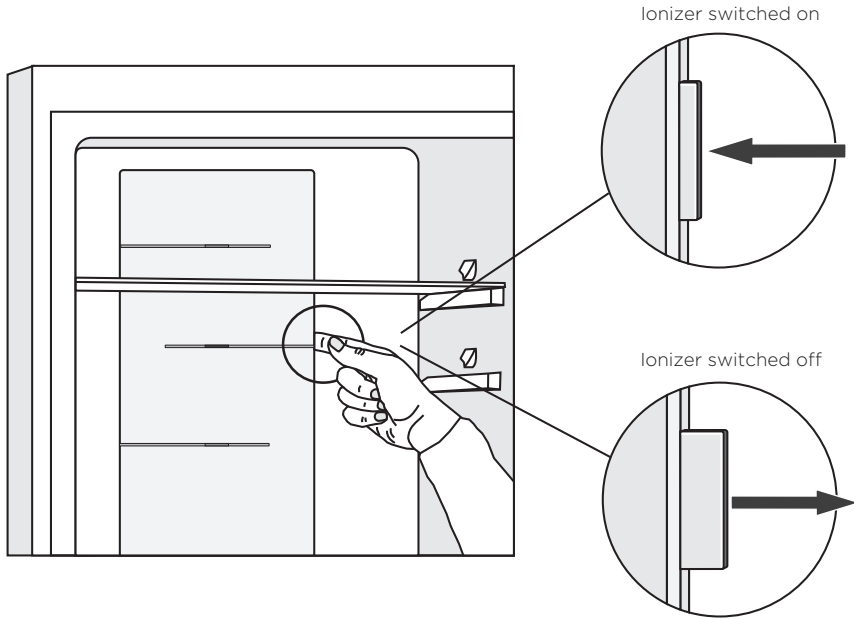

ADAPTIVE INTELLIGENT TECHNOLOGY

Innovative sensor technology allows adjusting appliance operation to the user's habits or behaviour. Adaptive intelligent system monitors, analyzes, and records on a daily and weekly basis the use of appliance and adapts appliance operation to the perceived patterns. If the appliance is able to anticipate increased frequency of door opening, the appliance will automatically lower the temperature before such time to prevent the increase of food temperature as the door is opened more often. The appliance will also anticipate adding larger amounts of food into the refrigerator or freezer and adapt by cooling or freezing more intensively.

RECOMMENDED DISTRIBUTION OF FOOD IN THE APPLIANCE

Sections of the refrigerator:

- **upper part:** canned food, bread, wine, pastry etc.
- **middle part:** dairy products, ready-made meals, desserts, soft drinks, beer, cooked food, etc.
- **FreshActive/ZeroZone drawer:** - meat, meat produce, delicatessen
- **CrispActive/CrispZone drawer:** fresh fruit, vegetables, salads, root vegetables, potatoes, onions, garlic, tomatoes, tropical fruit, sauerkraut, turnips etc.

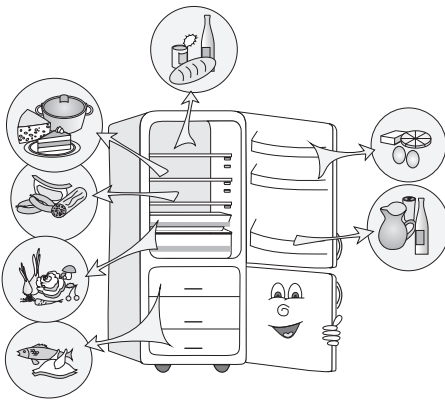

Sections in the refrigerator compartment door:

- **upper/middle door bins:** eggs, butter, cheese etc.
- **lower door bins:** beverages, cans, bottles etc.

Freezer sections/ZeroZone:

- **freezer:** freezing, storage of frozen food (see Freezing and Storing Frozen Food)
- **ZeroZone:** - meat, meat produce, delicatessen.

STORING FOOD IN THE REFRIGERATOR

IMPORTANT WARNINGS REGARDING FOOD STORAGE



Correct use of the appliance, appropriate packaging, maintaining the right temperature, and observing the food hygiene standards has a decisive impact on the quality of food storage.

Observe the expiry dates for the food, specified on the packaging.

Food stored in the refrigerator should be kept in closed containers or appropriate packaging to prevent them from emitting or receiving odours.

Do not store inflammable, volatile, and explosive substances in the refrigerator.

Bottles with high alcohol content should be tightly sealed and stored in an upright position.

Some organic solutions, essential oils in lemon and orange peel, butter acid, etc. may damage the plastic surfaces in case of a prolonged contact, causing damage and premature ageing of these materials.

Unpleasant odour warns of lacking cleanliness of the appliance or perished contents (see Cleaning the Appliance).

If you are leaving home for a longer period of time, remove perishables from the refrigerator.

FOOD STORAGE TIMES

Recommended storage time in the refrigerator

Type of food	Time
eggs, marinades, smoked meat	up to 10 days
cheese	up to 10 days
root vegetables	up to 8 days
butter	up to 7 days
deserts, fruit, ready-to-eat food, chunks of raw meat	up to 2 days
fish, raw minced meat, seafood	up to 1 day

STORING FOOD IN THE FRESHACTIVE DRAWER

In the **FreshActive** drawer, which is the coolest part of the refrigerator compartment, the food will stay fresh longer than in a conventional refrigerator and retain more flavour and nutrients.

Decay and loss of mass are slowed down; therefore, fruit and vegetables remain fresh and natural longer.

For optimum performance, the drawer should be fully closed.

- When buying food, make sure it is fresh as this will determine the quality of the food, as well as how long it will keep in the fridge.
- Store the food in closed containers or appropriate packaging to prevent them from emitting or receiving odours.
- Take the food from the drawer 30-60 minutes before use to allow the aroma and flavour develop at room temperature.
- Food sensitive to low temperature and not appropriate for storage in the **FreshActive** drawer include the following: pineapple, avocado, bananas, olives, potatoes, eggplant, cucumbers, beans, peppers (capsicum), melons, watermelons, pumpkins, squash, zucchini etc.

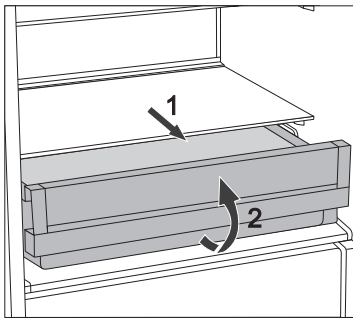

- To remove the drawer:
 - Pull out the drawer until it is blocked.
 - Then, lift it at the front and pull it all the way out.

STORING FOOD IN THE ZEROZONE DRAWER

The **ZeroZone** compartment allows storing a wide variety of fresh food for up to three times longer than in a conventional refrigerator. The food stays fresh longer, retaining the flavour and nutrients. The temperature in this drawer depends on the temperature settings in the refrigerator compartment, environment temperature, frequency of door opening, and amount of food placed in it. For a temperature around 0 °C in the ZeroZone drawer, we recommend setting the refrigerator compartment temperature to 4 °C or lower. Temperature in the ZeroZone drawer may fall below 0 °C. Therefore, place the temperature-sensitive food in the upper parts of the refrigerator.

For optimum performance, the drawer should be fully closed.

- When buying food, make sure it is fresh as this will determine the quality of the food, as well as how long it will keep in the fridge.
- Store the food in closed containers or appropriate packaging to prevent them from emitting or receiving odours and humidity.
- Take the food from the drawer 30-60 minutes before use to allow the aroma and flavour develop at room temperature.
- Food sensitive to low temperature and not appropriate for storage in the **ZeroZone** drawer include the following: pineapple, avocado, bananas, olives, potatoes, eggplant, cucumbers, beans, peppers (capsicum), melons, watermelons, pumpkins, squash, zucchini etc.

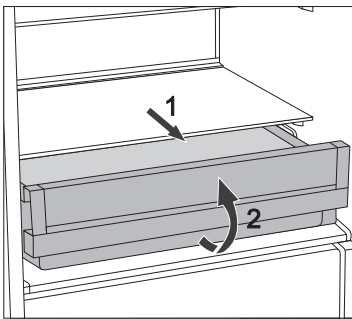

- To remove the drawer:
 - Pull out the drawer until it is blocked.
 - Then, lift it at the front and pull it all the way out.

STORING FOOD IN THE ZEROZONE COMPARTMENT

The **ZeroZone** compartment allows storing a wide variety of fresh food to keep up to three times longer than in a conventional refrigerator. The food stays fresh longer, retaining the flavour and nutrients.

- When buying food, make sure it is fresh as this will determine the quality of the food, as well as how long it will keep in the fridge.
- Store the food in closed containers or appropriate packaging to prevent it from emitting or receiving odours.
- Take the food from the drawer 30–60 minutes before use to allow the aroma and flavour develop at room temperature.
- Food sensitive to low temperature and therefore not appropriate for storage in the **ZeroZone** drawer includes the following: pineapple, avocado, bananas, olives, potatoes, eggplant, cucumbers, beans, peppers (capsicum), melons, watermelons, pumpkins and squash etc.

APPROXIMATE STORAGE TIME IN THE ZEROZONE DRAWER/COMPARTMENT*

Type of food	Time
sausages, cold cuts, beef, pork, venison, raw meat	up to 7 days
Poultry	up to 5 days
fish	up to 4 days
seafood	up to 3 days
Vegetables:	
cabbage, garlic, carrots	up to 180 days
celery, herbs	up to 30 days
Green lettuce, cauliflower, radicchio, rhubarb	up to 21 days
broccoli, asparagus, kale, Chinese cabbage, kohlrabi, radish	up to 14 days
onions, mushrooms, spinach, peas	up to 7 days
Fruit:	
apples	up to 180 days
pears, kiwi	up to 120 days
grapes, quinces	up to 90 days
peaches	up to 30 days
redcurrant, gooseberries, plums	up to 21 days
apricots, blueberries, cherries	up to 14 days
raspberries, strawberries	up to 3-5 days
Other:	
milk	up to 7 days
butter	up to 30 days
cheese	up to 30 days

* depending on the quality and freshness of food

FREEZING AND STORING FROZEN FOOD

FREEZING PROCESS



Maximum amount of fresh food that may be inserted at once is specified on the appliance rating plate. If the amount of food to be frozen exceeds the indicated amount, the quality of freezing will be inferior; in addition, the quality of the food already frozen will deteriorate.

- To make use of the entire freezer volume, remove all drawers. Place the food directly on the shelves and on the freezer bottom. Do not remove the bottom drawer in NO FROST appliances of A+++ energy class.
- Activate the super freeze function 24 hours before freezing fresh food:
 - press the **H** key.

After this time, insert the fresh food into the freezing compartment.

Make sure the fresh food is not in contact with the food that is already frozen!
The most appropriate compartment for freezing larger quantities of fresh ingredients is the upper compartment, or upper and middle compartment for appliances HZF3769E with energy efficiency class A+++.

- When freezing smaller quantities of food (1-2 kilograms), activating the super freeze function is not required.
- After 24 hours, the food can be moved to other freezer compartments and the freezing process can be repeated as necessary.

IMPORTANT WARNINGS ON FREEZING FRESH FOOD



Only freeze the food that is suitable for freezing in the freezer. Make sure the food you freeze is of high quality and fresh.

Choose appropriate packaging and use the packaging correctly.

Packaging should not be permeable to humidity; it should be airtight to prevent the food from drying out and loss of vitamins.

Label the food; indicate the type of food, amount, and date of freezing.

It is important that the food is frozen as quickly as possible. Therefore, keep the packages small. Refrigerate the food before freezing.

STORAGE OF INDUSTRIALLY FROZEN FOOD

- When storing and using frozen food, observe the manufacturer's instructions. Temperature and expiry date are indicated on the packaging.
- Only choose food with undamaged packaging, stored in freezers at temperatures of -18°C or lower.
- Do not purchase food covered in frost as this indicates they have been partly defrosted several times and that they are of inferior quality.
- Protect the food from thawing during transport. In case of an increase in temperature, storage time will be shorter and quality will deteriorate.

FROZEN FOOD STORAGE TIME

RECOMMENDED STORAGE TIME IN THE FREEZER

Type of food	Time
fruit, beef	from 10 to 12 months
vegetables, veal, poultry	from 8 to 10 months
Venison	from 6 to 8 months
Pork	from 4 to 6 months
minced meat	4 months
bread, pastry, ready-to-eat meals, lean	3 months
entrails	2 months
smoked sausage, fatty fish	1 month

DEFROSTING FROZEN FOOD

Freezing the food does not kill the microorganisms. After the food is defrosted or thawed, bacteria is re-activated and the food spoils quickly. Use the partially or completely defrosted food as soon as possible.

Partial thawing decreases the nutritive value of the food, particularly fruit, vegetables, and ready-to-eat food.

DEFROSTING THE APPLIANCE

AUTOMATIC REFRIGERATOR DEFROSTING

Refrigerator does not need defrosting because the ice on the back interior wall is thawed automatically.

Any accumulated ice will melt when the compressor unit is inactive. Drops will flow through an opening in the refrigerator rear wall into a tray fitted above the compressor, from where they will evaporate.

If an excessive layer of ice is formed on the rear wall of refrigerator interior (3-5 mm), switch off the appliance and defrost the appliance manually.

DEFROSTING A NO FROST FREEZER

- The NO FROST freezer will defrost automatically. Occasional frost that may appear on the walls will disappear automatically.
- Build-up of ice or frost in the freezer compartment can be a result of abnormal use of appliance (door opened too frequently and/or too long, door not properly closed etc.). In this case, unplug the appliance, remove the food from the freezer and protect them from defrosting.

Clean and dry the freezer interior. Before returning the frozen food into the freezer, switch on the appliance and select the desired setting.

CLEANING THE APPLIANCE

Before cleaning, unplug the appliance from the power mains – switch off the appliance (see chapter Switching the Appliance On/Off) and unplug the power cord from the wall outlet.

- Use a **soft cloth** to clean all surfaces. Cleaners that contain **abrasive substances, acids, or solvents are not suitable for cleaning** as they may damage the surface.

Clean the appliance **exterior** with water or a mild solution of suds. Lacquer-coated and aluminium surfaces may be cleaned with lukewarm water to which you have added a mild detergent. Use of cleaners with low alcohol content is allowed (e.g. window cleaners). Do not use cleaners containing alcohol for cleaning plastic materials.

Appliance interior can be cleaned with lukewarm water to which you can add some **vinegar**.

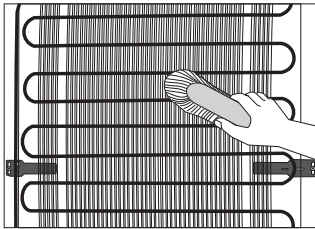

- **The condenser** unit mounted on the (exterior) back wall should always be kept clean, free of dust or deposits resulting from kitchen smoke or fumes. Occasionally clean the dust using a soft non-metal brush or a vacuum cleaner.
- After cleaning, switch the appliance back on and insert the food.

TROUBLESHOOTING

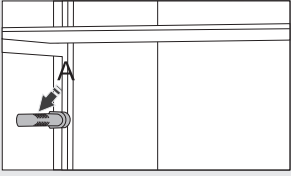
Problem:	Cause or remedy:
Appliance is connected to the power mains but it does not work.	<ul style="list-style-type: none"> • Make sure there is voltage in the power outlet and that the appliance is switched on.
Cooling system operates continuously for a long period of time: 	<ul style="list-style-type: none"> • Too high environment temperature. • Door opened too frequently or too long. • Door not closed correctly (possible impurities on the seal, misaligned door, damaged seal etc.). • Too much fresh food inserted at once. • Sensor in the refrigerator (A) blocked by fresh food. Make sure the air can circulate around the sensor (only with some models). • Insufficient compressor and condenser cooling. Check the air circulation behind the appliance and clean the condenser unit.
Excessive build-up of ice on the back wall of refrigerator interior can be a result of the following:	<ul style="list-style-type: none"> • Door opened too frequently or too long. • Warm food placed in the refrigerator. • Food in contact with the back interior wall of the refrigerator. • Poor door sealing. If the seal is dirty or damaged, clean it or replace it.
Build-up of ice or frost in the freezer interior may be a result of the following:	<ul style="list-style-type: none"> • Door opened too frequently or too long. • Door not properly closed. • Poor door sealing. • If the seal is dirty or damaged, clean or replace it.
Condensate (dew) on the shelf above the drawers:	<ul style="list-style-type: none"> • This is a transient phenomenon which cannot be entirely avoided in periods of high environment temperature and humidity. It subsides when temperature and humidity are normalized. We recommend cleaning the drawers more frequently and wiping the droplets occasionally. • Open the humidity control slider. • Place the food in to bags or other airtight packaging.
Water leaking from the refrigerator:	<ul style="list-style-type: none"> • Clogged water discharge opening or water dripping past the water gutter. • Clean the clogged opening, for example using a plastic straw. • If a thick layer of ice builds up, defrost the appliance manually (see Defrosting the Appliance).
Temperature display flashes:	<ul style="list-style-type: none"> • Door opened too frequently or too long. • Door not closed correctly (possible impurities on the seal, misaligned door, damaged seal etc.). • A longer power failure. • Too much fresh food inserted at once.

Problem:	Cause or remedy:
Door is difficult to open:	<ul style="list-style-type: none"> • If you are trying to open the freezer door after just having closed it, this could be difficult to do. As you open the door, some cool air escapes from the appliance and it is replaced by warm air from the environment. When this air is cooled, negative pressure is generated which results in problems as you try to open the door. After a few minutes, the condition is normalized and the door can be easily opened again.
LED lighting does not work:	<ul style="list-style-type: none"> • If LED lighting does not work, call a service technician. • Do not attempt a repair of the LED lighting yourself, as there is danger of contact with high voltage!
VitaLED lighting does not work:	<ul style="list-style-type: none"> • If the VitaLED lighting does not work, call a service technician.
Indication of error code on the display (only with some models):	<ul style="list-style-type: none"> • If E appears on the display, call a service technician.

If none of the instructions above fixes your problem, call the nearest authorized service center and state the type, model, and serial number found on the rating plate/label which is located in the appliance interior.

INFORMATION ABOUT APPLIANCE NOISE

Cooling in refrigerator freezers is made possible by a cooling system that also includes a compressor (and a fan with some appliances), which generates some noise. The level of noise depends on installation, proper use, and age of the appliance.

- **After connecting the appliance to the power mains**, compressor operation, or the sound of flowing liquid, may be somewhat louder. This is not a sign of malfunction and it will not affect the useful life of the appliance. In time, appliance operation and this noise will become quieter.
- Sometimes, **unusual or loud noise** may appear during appliance operation; these are mostly the result of improper installation:
 - The appliance must stand level and stable on a solid base.
 - The appliance may not be in contact with a wall or adjacent furniture.
 - Make sure the interior equipment sits firmly in its place and that the noise is not caused by cans, bottles or other containers placed next to each other.
- Due to the higher workload on the cooling system when the door is opened more frequently or for a longer time, when a large amount of fresh food is introduced, or when intensive freezing or cooling functions are activated, the appliance can temporarily generate more noise.

WE RESERVE THE RIGHT TO MAKE CHANGES THAT DO NOT AFFECT THE FUNCTIONALITY OF THE APPLIANCE.

Instructions for use of the appliance can also be found on our website at www.gorenje.com / < <http://www.gorenje.com> />

COMBI_FS600_SUPERIOR



en (01-18)