

# INFINITY

## Instructions for Use

EN



We thank you for your trust and the purchase of our appliance.

This detailed instruction manual is supplied to make the use of this product easier. The instructions should allow you to learn about your new appliance as quickly as possible.

Make sure you have received an undamaged appliance. If you do find transport damage, please contact the seller from which you purchased the appliance, or the regional warehouse from which it was supplied. The telephone number can be found on the invoice or on the delivery note.

Instructions for installation and connection are supplied on a separate sheet.

Instructions for use are also available at our website:

[www.gorenje.com](http://www.gorenje.com) / < <http://www.gorenje.com> />



Important information



Tip, note

# CONTENTS

<b>4 COMBINED FREE STANDING COOKER</b> 8 Control unit 10 Technical specifications	<b>INTRODUCTION</b>
<b>11 IMPORTANT SAFETY INSTRUCTIONS</b> 13 Before connecting the oven:	
<b>14 BEFORE USING THE APPLIANCE FOR THE FIRST TIME</b>	<b>PREPARING THE APPLIANCE FOR THE FIRST USE</b>
<b>15 COOKING HOB</b>	
<b>19 SWITCHING ON THE APPLIANCE FOR THE FIRST TIME</b> 19 SETTING THE CLOCK	
<b>20 STEPS OF THE COOKING PROCESS (1-6)</b> 20 Step 1: CHOOSING THE COOKING SYSTEM 22 Step 2: CHOOSING THE SETTINGS 23 Step 3: TIMER FUNCTIONS 25 Step 4: SELECTING ADDITIONAL FUNCTIONS/EXTRAS 27 Step 5: STARTING THE COOKING PROCESS 27 Step 6: SWITCHING OFF THE OVEN	<b>COOKING STEPS</b>
<b>28 DESCRIPTIONS OF SYSTEMS (COOKING MODES) AND COOKING TABLES</b>	
<b>42 MAINTENANCE &amp; CLEANING</b> 43 Cleaning the cooking hobs 43 Gas burner 44 Conventional oven cleaning 45 Using the aqua clean function to clean the oven 46 Removing and cleaning wire and telescopic extendible guides 47 Installing the catalytic inserts 48 Cleaning the oven cavity ceiling 49 Removing and inserting the oven door 51 Removing and inserting the oven door glass pane 52 Replacing the bulb	<b>MAINTENANCE &amp; CLEANING</b>
<b>53 TROUBLESHOOTING TABLE</b>	<b>TROUBLE-SHOOTING</b>
<b>54 COOKING TEST</b>	<b>FOOD TEST</b>
<b>56 INSTALLATION AND CONNECTION INSTRUCTIONS</b>	<b>INSTALLATION INSTRUCTIONS</b>
<b>62 NOZZLE TABLE</b>	
<b>63 DISPOSAL</b>	<b>OTHER</b>

# COMBINED FREE STANDING COOKER

## (DESCRIPTION OF THE OVEN AND EQUIPMENT - DEPENDING ON THE MODEL)

Since the appliances for which these instructions were drawn up may have different equipment, some functions or equipment may be described in the manual that may not be present in your appliances.

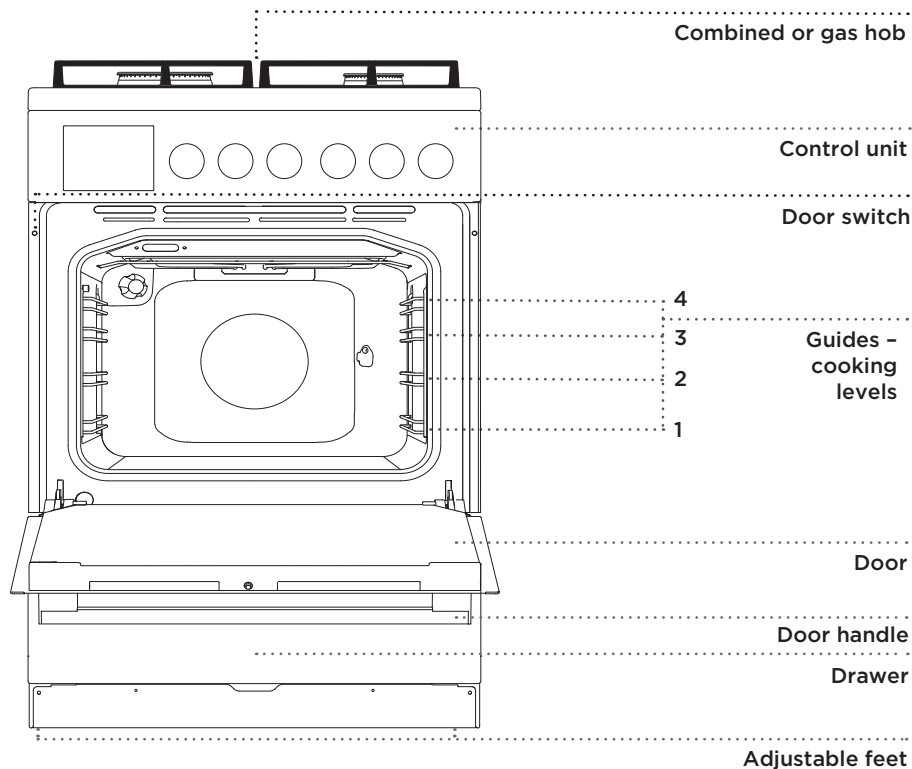

## APPLIANCE LID

Make sure the lid is clean and that there is no liquid spilt on it before raising it. The lid may be lacquer-coated or glass. It may only be closed when the cooking zones have completely cooled down.



The symbol on the product or its packaging indicates that glass lids may shatter when heated. Turn off all the burners before shutting the lid.

## APPLIANCE DRAWER



Do not store combustible, explosive, volatile or temperature-sensitive items (such as paper, dish cloths, plastic bags, cleaners or detergents and spray cans) in the oven's storage drawer, as they can ignite during over operation and cause a fire.

## CONTROL LIGHT

**When a function is selected**, the dial of the selected knob will be lit up. These appliances do not have a yellow light (only with some models).

**Oven lighting** will be switched on automatically when the cooking system is selected.

## WIRE GUIDES

The wire guides allow preparation of the food on four levels (please note that the levels/guides are counted from the bottom up).

Guides 3 and 4 are intended for grilling.

## TELESCOPIC PULL-OUT GUIDES

Telescopic pull-out guides may be fitted for the 2nd, 3rd, and 4th level.

Pull-out guides can be partly or fully extendible.

## OVEN DOOR SWITCH

The switch deactivates oven heating and the fan when the oven door is opened during the cooking process. When the door is closed, the switch turns the heaters back on.

## COOLING FAN

The appliance is fitted with a cooling fan that cools the housing and the appliance control panel.

## EXTENDED OPERATION OF THE COOLING FAN

After the oven is switched off, the cooling fan continues to operate for a short while in order to cool the oven.

## OVEN EQUIPMENT AND ACCESSORIES

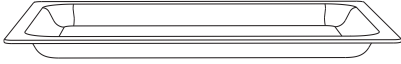

**GLASS BAKING DISH** is used for cooking with all oven tray systems. It can also be used as a serving tray.



The **GRID** is used for grilling or as support for a pan, baking tray or baking dish with the food.



There is a safety latch on the grid. Therefore, lift the grid slightly at the front when pulling it out from the oven.

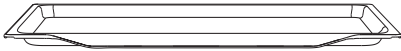

The **SHALLOW BAKING SHEET** is used for baking pastry and cakes.

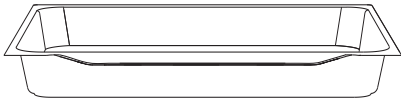

The **DEEP BAKING TRAY** is used for roasting meat and baking moist pastry. It can also be used as a drip tray.



Never place the deep baking tray in the first guide during the cooking process, except when grilling food or using the roasting spit and you are only using the deep tray as a drip tray.

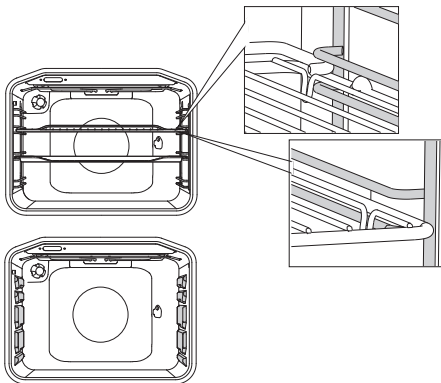

The grid or the tray should always be inserted into the groove between the two wire profiles.

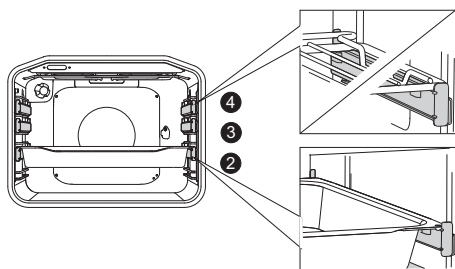

With telescopic extendible guides, first pull out the guides of one level and place the grid or the baking tray onto them. Then, push them in with your hand as far as they will go.

 Close the oven door when the telescopic guides are retracted all the way into the oven.

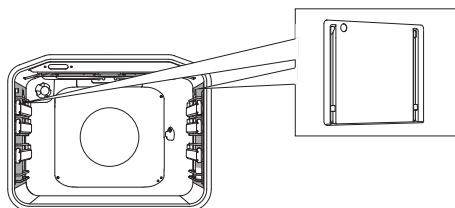

**CATALYTIC INSERTS** prevent the spraying fat from sticking to sides of the oven cavity.



The **ROTISSERIE** (meat skewer) is used for roasting meat. The set consists of a skewer support, skewer with screws, and a removable handle.



The appliance and some of the accessible parts tend to heat up during cooking. Use oven mitts.

# CONTROL UNIT

(DEPENDING ON THE MODEL)

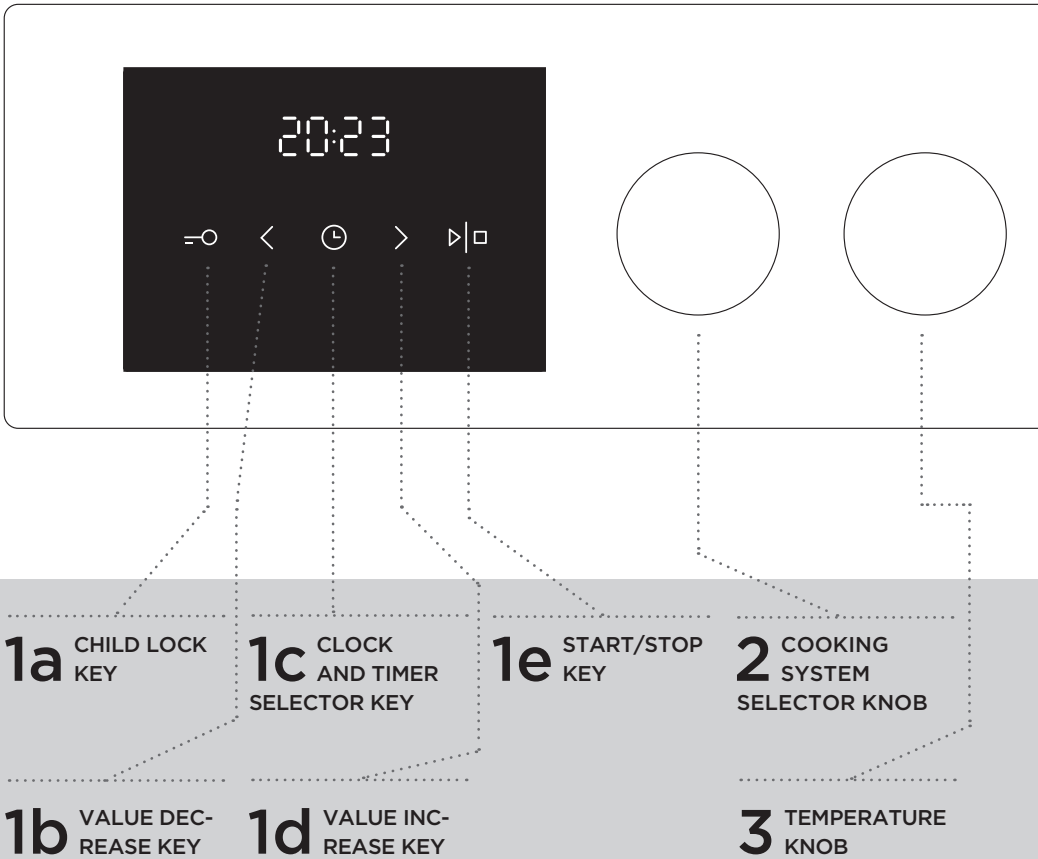

**NOTE:**

Symbols of cooking systems may be located on the knob or on the front panel (depending on the appliance model).



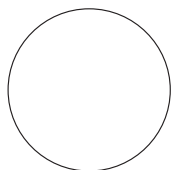

**4** TEMPERATURE  
KNOB

electric cooking  
zone or gas burner

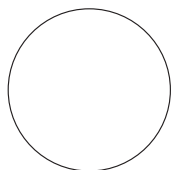

**5** COOKING  
ZONE KNOB,  
FRONT LEFT

electric cooking  
zone or gas burner

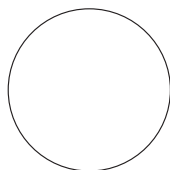

**6** COOKING ZONE  
KNOB, FRONT  
RIGHT

gas burner

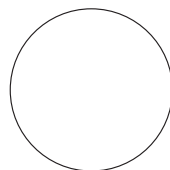

**7** COOKING ZONE  
KNOB, REAR  
RIGHT

gas burner

# TECHNICAL SPECIFICATIONS

(DEPENDING ON THE MODEL)

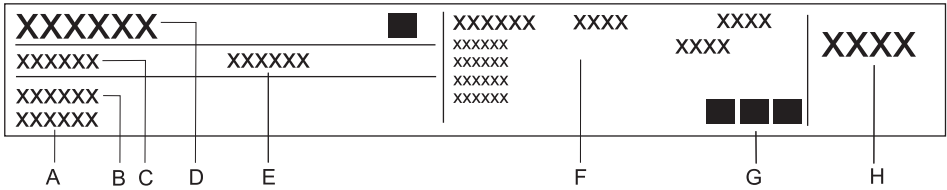

- A Serial number
- B Model
- C Type
- D Trademark
- E Code
- F Technical information
- G Compliance indications / symbols
- H Factory settings for gas type

The rating plate indicating the basic information about the appliance is located at the edge of the oven and it is visible when the oven door is opened.

# IMPORTANT SAFETY INSTRUCTIONS

---



**CAREFULLY READ THE INSTRUCTIONS AND SAVE THEM FOR FUTURE REFERENCE.**

This appliance may only be used by children aged 8 years and above and persons with reduced physical, sensory or mental capabilities or lack of experience and knowledge if supervision or instructions are provided to them concerning use of the appliance in a safe way and if they understand the hazards involved. Do not let the children play with the appliance. Cleaning and user maintenance shall not be made by children without supervision.

**WARNING:** The appliance and some of its accessible parts may become very hot during use. Be careful not to touch the heaters. Children younger than 8 years should be constantly supervised.

The appliance becomes very hot during use. Be careful not to touch the oven heaters.

**WARNING:** The accessible parts of the appliance may become hot during use. Children should be kept away from the oven.

**WARNING:** Danger of fire: do not store items on the cooking surfaces.

**WARNING:** Unattended cooking on a hob with fat or oil can be dangerous and may result in fire. Never try to extinguish a fire with water, but switch off the appliance and then cover flame with a lid or a damp cloth.

**WARNING:** If the surface is cracked, switch off the appliance to avoid the possibility of electric shock.

Only use the temperature probe recommended for use in this oven.

**WARNING:** Before replacing the light bulb, make sure the appliance has been disconnected from the power mains, in order to prevent the hazard of an electric shock.

Do not use abrasive cleaners or sharp metal scrapers to clean the oven as they may damage the finish or the protective enamel coating. Such damages may lead to cracking of the glass.

Do not use steam cleaners or high-pressure cleaners to clean the cooking hob, as this may result in an electric shock.

The appliance is not intended to be controlled by external timers or special control systems.

The appliance is intended for household use. Do not use it for any other purpose, such as room heating, drying of pets or other animals, paper, fabrics, herbs etc. as this may lead to injury or fire hazard.

The appliance is intended to be placed directly on the floor, without any supports or plinths.

The appliance may only be connected by an expert authorized by the gas distribution company or an authorized service center. All relevant legislation and local gas distributor's technical conditions for connection to the gas mains should be complied with.

Unauthorized service and repair can result in risk of explosion, electric shock, or short circuit and consequently personal injury and damage to the appliance.

Such tasks may only be carried out by an authorized expert.

Before installing and connecting the appliance, make sure the local connection conditions and characteristics (gas type and pressure) are compatible with the appliance set-up.

The set-up of the appliance is specified on the rating plate.

The appliance is not connected to a flue or a ventilation opening. The appliance should be installed and connected in compliance with the relevant regulations on connection. Heat, moisture, and combustion by-products are released during the use of the cooking appliance in the room where it is installed. Make sure your kitchen is adequately ventilated, especially during the use of appliance.

Open all natural ventilation openings or install a mechanical ventilation device (a mechanical kitchen hood).

This is a class 2/14 appliance. The appliance may touch the adjacent cabinets on both sides when placed in a row. On one side, a tall cabinet – taller than the appliance – may be placed at a distance of at least 10 cm from the appliance. On the other side, only a cabinet of the same height may be placed.

Pay attention to correct placement of the burner parts.

If you smell gas in the room, immediately close the main inlet valve on the gas cylinder or the gas grid, extinguish any fire (including cigarettes), ventilate the room, do not switch on any electrical devices, and call a natural gas expert.

Close the main inlet valve if you do not intend to use the burners for a longer period of time (e.g. before leaving on vacation).

If the power cords of other appliances located near this appliance are caught in the oven door, they may be damaged, which may in turn result in a short circuit. Therefore, keep the power cords of other appliances at a safe distance.

If the power cord is damaged, it should be replaced by the manufacturer or an authorized service technician, in order to avoid hazard.

Do not line the oven walls with aluminium foil and do not place baking trays or other cookware on the oven bottom. Aluminium foil would prevent air circulation in the oven, hinder the cooking process, and ruin the enamel coating.

Oven door become very hot during operation. A third glass is installed for extra protection, reducing the temperature of the outside surface (only with some models).

Oven door hinges may be damaged when under excessive load. Do not place heavy pans on open oven door and do not lean against open oven door when cleaning the oven cavity. Never stand on the open oven door and do not let children to sit on it.

Appliance operation is safe with and without tray guides.

Make sure the vents are never covered or obstructed in any other way.

## BEFORE CONNECTING THE OVEN:



**Carefully read the instructions for use before connecting the appliance. Repair or any warranty claim resulting from incorrect connection or use of the appliance shall not be covered by the warranty.**

# BEFORE USING THE APPLIANCE FOR THE FIRST TIME

---

If your **cooking hob** has conventional cooking zones, switch them on to the maximum power for 3 to 5 minutes without any cookware on them. As the cooking zones heat up, some smoke may appear on the cooking hob surface. Thus, the cooking zone finish reaches its maximum resistance.

Upon receiving the appliance, remove all parts, including any transport equipment, from the oven.

Clean all accessories and utensils with warm water and regular detergent. Do not use any abrasive cleaners.

Before using the oven for the first time, heat it with the upper and lower heater system at 200 °C for approximately one hour. The characteristic "new appliance" scent will be released; make sure the room is well ventilated.

# COOKING HOB

## CONVENTIONAL HOBS

- Make sure the cooking zone and the cookware bottom is clean and dry. This will allow better conduction of heat and prevent any damage to the heating surface.
- Overheated fat and oil on the cooking zones may ignite. Therefore, be careful when cooking with fat or oil and always control the cooking process.
- Do not place wet cookware or lids covered in steam on the cooking zones. Moisture may damage the cooking zones.
- Do not cool down the hot cookware by placing it on the cooking zones that were not in use, because the condensate that will appear under the cookware bottom may aid corrosion.

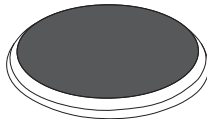
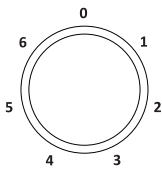

Rotate the knob to switch on the cooking zone. Cooking zone heating power can be set in steps from 1 to 6 or continuously from 1 to 4.



Switch off the cooking zone 3 - 5 minutes before the end of the cooking process to make use of the residual heat and save power.



**Rapid cooking zones** (only with some models) can operate with greater power than regular cooking zones, which means they can heat up more quickly.

These cooking zones are indicated with a **red dot** in the middle. After repeated heating and cleaning, this dot may disappear.



### Residual heat indicator

Every cooking zone has a signal light that lights up when the cooking zone is hot. When the cooking zone cools down, the signal light goes out. The residual heat indicator is also lit up if a hot pot or pan is placed on a cool cooking zone.



**In case of prolonged use of cast iron plates, the area of the plate and the edge of the cooking zone may discolour. Service in such case is not covered by the warranty.**

## TIPS REGARDING YOUR COOKWARE

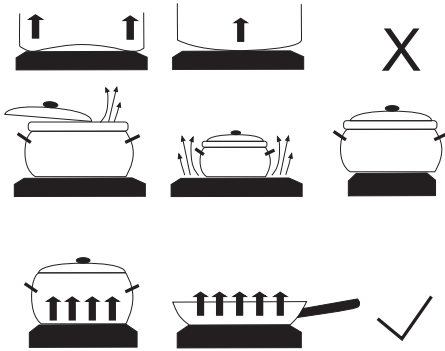

- Use quality cookware with flat and stable bottom.
- Pan bottom and cooking zone diameters should be the same.
- Tempered glass cookware with special ground bottom may be used on the cooking zones if its diameter fits that of the cooking zones. Cookware with larger diameter may crack due to thermal tension.
- Make sure the pot or pan is in the middle of the cooking zone.

- When using a pressure cooker, keep an eye on it until the right pressure is reached. First, set the cooking zone to maximum power; then, following the pressure cooker manufacturer's instructions, use the relevant sensor to decrease the cooking power at the right time.
- Make sure there is enough liquid in the pressure cooker, or any other pot or pan. Due to overheating, using an empty pot on the cooking zone may result in damage to both the pot and the cooking zone.
- When using special cookware, observe the manufacturer's instructions.

## ENERGY SAVING TIPS

- Diameter of the pot and pan bottoms should match the diameter of the cooking zone. If the pot or pan is too small, a part of the heat will be lost, and the cooking zone may be damaged.
- If the cooking process allows, use a lid.
- Cookware should be suitably sized given the amount of food. When you cook a small amount of food in a large pot or pan, more energy is lost.
- If a dish takes a long time to cook, use a pressure cooker.
- Vegetables, potatoes etc. may be cooked in a smaller amount of water. The food will cook just as well, as long as the pot is tightly closed with a lid. After bringing the water to a boil, reduce the heat to a level that just suffices to maintain a slow simmer.



## GAS BURNERS

- To sear the food, set the burner to maximum power first, and then continue to cook at minimum power.
- In some models, the cooker burners are fitted with thermoelectric safety devices. If the burner flame is extinguished (due to boiling over, draft etc.), gas supply will be shut off automatically. Any chance of gas leaking into the room is eliminated.
- If the burner flame is extinguished on a cooker without a thermoelectric safety device, the gas will leak into the room!
- Always place the burner cap accurately on the burner crown. Make sure the slots in the burner crown are never blocked.

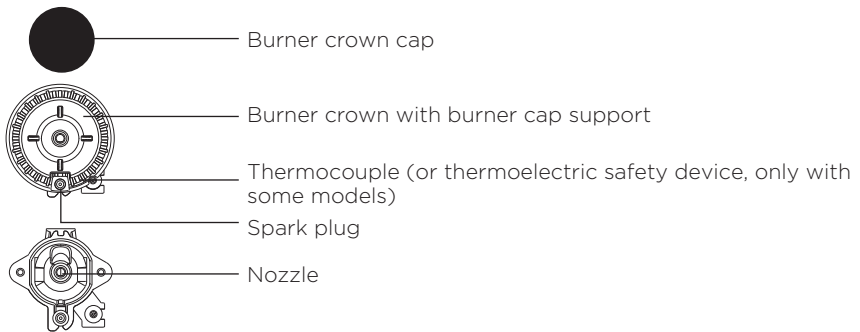

### TIPS REGARDING YOUR COOKWARE

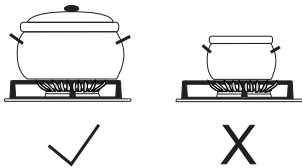

- Correct choice of cookware allows optimum cooking time and gas consumption. Cookware diameter is the most important in this respect.
- If a pot or a pan is too small, the flames reaching over the edge of its bottom will damage it. Moreover, gas consumption will be higher.
- Combustion of gas also requires air. If the pot or pan is too large, there is not enough air and the burning efficiency is decreased.

**Gas hob reducer** (only with some models) Use the gas hob reducer when cooking in a container of smaller diameter. Place it on the grid over the auxiliary burner.

Burner type	Container diameter
Large (3.0 kW)	220-260 mm
Normal (1.9 kW)	180-220 mm
Auxiliary (1.9 kW)	120-180 mm
Three-ring (3.5 kW)	220-260 mm

## BURNER IGNITION AND OPERATION



Always press the knob before rotating it.

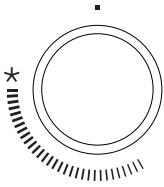

On the knobs, heating power levels are indicated with thick and thin markings. Rotate the knob past the asterisk (\*) position and the thick markings to the thin markings position and back. Operating position is within the range indicated by the markings. Settings between (\*) and (■) are not recommended. In this range, the flame is unstable and may be extinguished.



Place the pot or pan on the grid above the burner before igniting it (applies to three-ring, double-ring, and mini-wok burner). To turn off a burner, rotate the knob to the right to position (■).

### Single-handed ignition



To ignite a gas burner, press the corresponding knob and rotate it to the maximum power position. Electric spark from the spark plug will be activated and the gas will ignite.

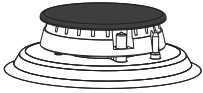

### Two-handed ignition

To ignite a gas burner, press the corresponding knob and rotate it to the maximum power position. **Press the spark plug button.** Electric spark from the spark plug will be activated and the gas will ignite.



Electric ignition will only work if the power cord is connected to the power mains. If electric ignition does not work due to a power supply failure or damp spark plugs, the gas can still be ignited with a match or a lighter. After ignition, keep the knob depressed for approximately 10 more seconds until the flame is stabilized.

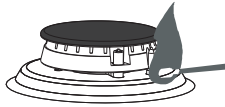

**If the burner does not ignite in 15 seconds, close it and wait for at least 1 minute. Then, repeat the ignition process.**

**If the flame on a burner is extinguished (regardless of the reason), close the burner and wait for 1 minute before trying to ignite it again.**

# SWITCHING ON THE APPLIANCE FOR THE FIRST TIME

---

## SETTING THE CLOCK

After connecting your appliance or after an extended power outage, 12:00 will flash on the display and the symbol will light up ☹.

Set the time of day.

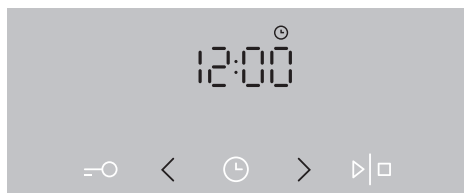

**1** Touch the < and > keys to set the time of day.

 If you press and hold the value adjustment key, the rate at which the set value is being changed will increase.

## CHANGING THE CLOCK SETTING

Clock settings may be changed when no timer function is activated. To set the current time (clock), touch the CLOCK key several times to select the ☹ symbol.

# STEPS OF THE COOKING PROCESS (1-6)

## STEP 1: CHOOSING THE COOKING SYSTEM

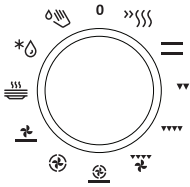





Rotate the knob (left and right) to select the cooking system (see program table).



Settings can also be changed during the cooking process.



SYSTEM	DESCRIPTION	SUGGESTED TEMPERATURE °C
<b>COOKING SYSTEMS</b>		
»»»»	<b>RAPID PREHEAT</b> Use this function if you wish to heat the oven to the desired temperature as quickly as possible. This function is not appropriate for cooking food. When the oven heats up to the desired temperature, the heating process is completed.	160
==	<b>UPPER AND BOTTOM HEATER</b> The heaters in the bottom and in the ceiling of the oven cavity will radiate heat evenly into the oven interior. Pastry or meat can only be baked/roasted at a single height level.	200
▼▼	<b>GRILL</b> Only grill heater, a part of the large grill set, will operate. This system is used for grilling a smaller amount of open sandwiches or beer sausages, and for toasting bread.	220
▼▼▼	<b>LARGE GRILL</b> The upper heater and the grill heater will operate. The heat is radiated directly by the grill heater installed in the oven ceiling. To boost the heating effect, the upper heater is activated as well. This combination is used for grilling a smaller amount of open sandwiches, meat or beer sausages, and for toasting bread.	220
▼▼▼	<b>GRILL WITH FAN</b> Grill heater and the fan will operate. This combination is used to grill meat and to roast larger chunks of meat or poultry at a single height level. It is also appropriate for dishes au gratin and for browning to a crispy crust.	170
⊕	<b>HOT AIR AND BOTTOM HEATER</b> The bottom heater, the round heater, and the hot air fan will operate. This is used to bake pizza, moist pastry, fruitcakes, leavened dough and shortcrust on several levels simultaneously.	200

SYSTEM	DESCRIPTION	SUGGESTED TEMPERATURE °C
	<b>HOT AIR</b> Round heater and the fan will operate. The fan installed in the back wall of the oven cavity makes sure the hot air constantly circulates around the roast or pastry. This mode is used for roasting meat and baking pastry at several levels simultaneously.	180
	<b>BOTTOM HEATER AND FAN</b> This is used for baking leavened but low-rising pastry and for preserving fruit and vegetables.	180
	<b>PLATE WARMER</b> Use this function to reheat your dinnerware (plates, cups) before serving food in it to keep the food warm longer.	60
	<b>DEFROSTING</b> The air circulates with no heaters activated. Only the fan will be activated. This is used to slowly thaw frozen food.	-
	<b>AQUA CLEAN</b> Only the bottom heater will radiate heat. Use this function to remove stains and food residues from the oven. The program takes 30 minutes.	70

# STEP 2: CHOOSING THE SETTINGS

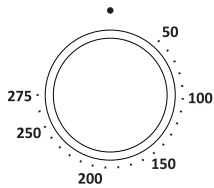
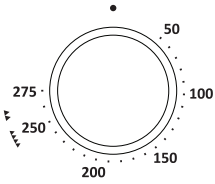
## ADJUSTING THE COOKING TEMPERATURE



 When using the oven system with the large grill and grill, set the temperature knob to position .



Rotate the knob to set the desired TEMPERATURE.

After switching on the appliance by touching the START key, the temperature icon is displayed on the display unit.

 To switch on the appliance, press the START key and hold it for a while - about 1 second.

## STEP 3: TIMER FUNCTIONS

First rotate the COOKING SYSTEM SELECTOR KNOB; then, set the temperature.

Touch the TIMER key several times to select the desired timer function.

The icon for the selected timer function will light up and the adjustable cooking start/end time will flash on the display.

Press START to start the cooking process. ELAPSED COOKING TIME will be displayed.

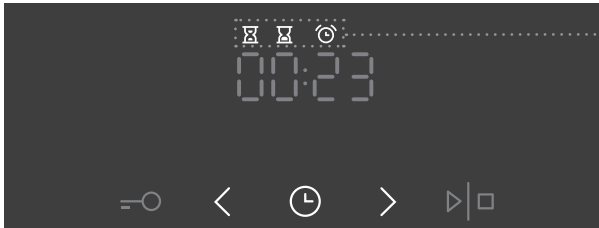

Timer function display

### **Setting the cooking time**

In this mode, you can define the duration of oven operation (cooking time). Set the desired cooking time. First set the minutes, then the hours. Icon and cooking time are displayed on the display unit.

### **Setting the delayed start**

In this mode, you may specify the duration of the cooking process (cooking time) and the time when you wish the cooking process to stop (end time). Make sure the clock is accurately set to current time.

Example:

Current time: noon

Cooking time: 2 hours

End of cooking: 6 pm

First set the OPERATION DURATION (2 hours). Touch the CLOCK button twice to select the END OF OPERATION. The display automatically shows a flashing sum of the time of day and duration of operation of the oven (14:00).

Set the time for the end of baking (18:00).

Press START to start the cooking process. The timer will wait for the time to start the cooking process and the symbol will be lit up. The oven automatically switches on (at 4 pm) and stops operating and the selected time (at 6 pm).



## Setting the minute minder

The minute minder can be used independently of the oven operation. The longest possible setting is 24 hours.

During the last minute, the minute minder is displayed in seconds.



After the set time expires, the oven will automatically stop operating (end of cooking). An acoustic signal will be heard which you may turn off by touching any key. After one minute, the acoustic signal will be switched off automatically.

Timer functions can be cancelled by setting the time to "0". Any timer function may also be quickly cancelled by simultaneously pressing the < and > key and holding them for a while.



## STEP 4: SELECTING ADDITIONAL FUNCTIONS/EXTRAS

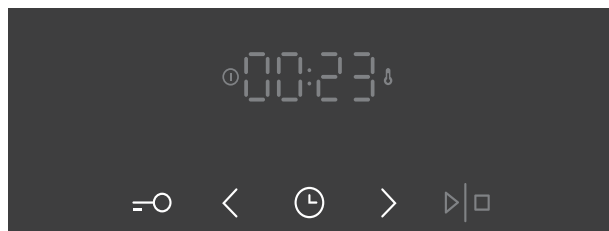

Activate/deactivate the functions by pressing the desired key or a combination of keys.

---

### **CHILD LOCK**

Activate it by touching the CHILD LOCK key. "Loc" will appear on the display unit for 5 seconds. Touch the key again to deactivate the child lock.

If the child lock is activated with no timer function engaged (only clock is displayed), then the oven will not operate. If the child lock is activated after a timer function has been set, then the oven will operate normally; however, it will not be possible to change the settings.

When the child lock is activated, the systems can be changed, but it is not possible to change the extra functions. The cooking process can be ended by rotating the selector knob to "0". Child lock will remain active after the oven is switched off. To select a new system, the child lock must first be deactivated.

### **OVEN LIGHTING**

Oven lighting will be switched on automatically each time a cooking system is selected.

## 5sek < **ACOUSTIC SIGNAL**

Loudness of the acoustic signal can be set when no timer function is activated (only the time of day is displayed).

Press the < key and hold it for five seconds. First, "Vol" will appear on the display unit, followed by two fully lit bars. Touch the < and > keys to choose one of the three volume levels (one, two, or three bars). After three seconds, the setting will be automatically stored and the time of day will appear.

## 5sek > **DECREASING THE DISPLAY CONTRAST**

The cooking system selector knob has to be in position "0".

Hold the > key for 5 seconds. First, "bri" will appear on the display unit, followed by two fully lit bars. Touch the < and > keys to adjust the display dimmer (one, two, or three bars). After three seconds, the setting will be automatically saved.



After a power outage or after the appliance is switched off, the additional function settings will remain stored for no more than a few minutes. Then, all settings, except for the acoustic signal, display dimmer, and child lock will be reset to factory defaults.

## STEP 5: STARTING THE COOKING PROCESS

Start the cooking process by pressing the START/STOP key and holding it for a while. Temperature and operation symbols will be lit up.

If no timer function is selected, the cooking duration time, cooking time will appear on the display unit.

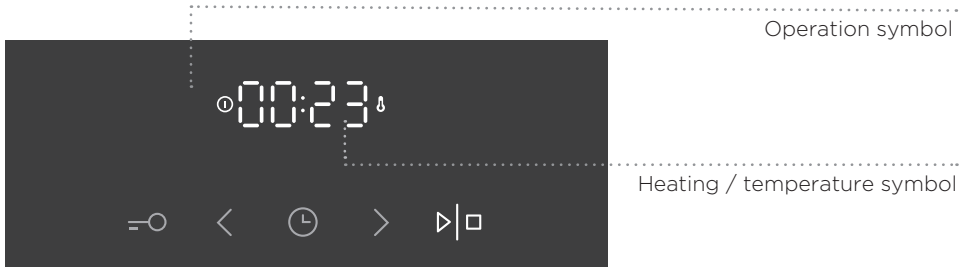



While the oven is heating up, the temperature symbol will flash. When the oven reaches the set temperature, the symbol will light up and a short beep will be sounded.

## STEP 6: SWITCHING OFF THE OVEN

To stop the cooking process, press and hold the START/STOP key.

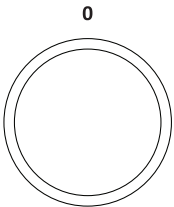
Turn the COOKING SYSTEM SELECTOR and TEMPERATURE KNOB to position "0".



 After the cooking process, all timer settings are also paused and cancelled, except for the minute minder. Time of day (clock) will be displayed. The cooling fan will continue to operate for a while.

# DESCRIPTIONS OF SYSTEMS (COOKING MODES) AND COOKING TABLES

---

If your desired food cannot be found in the cooking table, find information for similar food. The information displayed applies to cooking in a single level.

An interval of suggested temperature is indicated. Start with a lower temperature setting and increase it if you find the food is not browned sufficiently.

Cooking times are rough estimates and may vary subject to some conditions.

**Only preheat the oven** if required by the recipe of in the tables in this instruction manual. Heating an empty oven consumes a lot of energy. Hence, baking several types of pastry or several pizzas successively will save a lot of energy as the oven will already have been preheated.

Use dark, black silicon-layered or enamel-coated baking sheets and trays as they conduct the heat very well.

When using parchment paper, make sure it is resistant to high temperatures.

When cooking larger chunks of meat or pastry, a lot of steam will be generated inside the oven, which in turn may condense on the oven door. This is a normal phenomenon which will not affect the operation of the appliance. After the cooking process, wipe the door and the door glass dry.

**Switch off the oven approximately** 10 minutes before the end of the cooking process to save energy by making use of the accumulated heat.

Do not cool the food in a closed oven to prevent condensation (dew).



**The asterisk (\*) in the table means the oven should be preheated with the selected system.**

# COOKING SYSTEMS

## UPPER AND BOTTOM HEATER

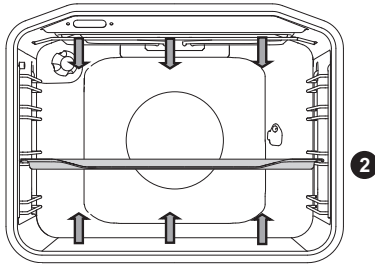

The heaters in the bottom and in the ceiling of the oven cavity will radiate heat evenly into the oven interior.

### Roasting meat:

Use enamel coated, tempered glass, clay, or cast iron pan or tray. Stainless steel trays are not suitable as they strongly reflect the heat.

Use enamel coated, tempered glass, clay, or cast iron pan or tray. Stainless steel trays are not suitable as they strongly reflect the heat.

Food	Weight (g)	Guide (from the bottom)	Temperature (°C)	Cooking time (minutes)
<b>MEAT</b>				
Pork roast	1500	2	190-200	120-130
Pork shoulder	1500	2	190-200	120-140
Pork roulade	1500	2	190-200	120-140
Meat loaf	1500	2	200-210	60-70
Beef roast	1500	2	190-210	120-140
Roast beef, well done	1000	2	200-210	40-60
Veal roulade	1500	2	180-200	90-120
Lamb sirloin	1500	2	190-200	100-120
Rabbit loin	1500	2	190-200	100-120
Deer shank	1500	2	190-200	100-120
Pizza *	/	2	220	25
Chicken	1500	2	200	80
<b>FISH</b>				
Braised fish	1000	2	210	50-60

Use this system to roast chicken, if the appliance does not have the  system.

Use this system to bake pizza, if the appliance does not have the  system.

## Baking pastry

Only use one level and dark baking sheets or trays. In light-coloured baking sheets or trays, the browning of the pastry will be poorer, as such equipment will reflect the heat. Always place the baking trays on the grid. If you are using the supplied baking sheet, remove the grid. Cooking time will be shorter if the oven is preheated.

Food	Guide (from the bottom)	Temperature (°C)	Cooking time (minutes)
<b>PASTRY</b>			
Vegetable soufflé	2	190-200	30-35
Sweet soufflé	2	190-200	30-35
Rolls *	2	200-220	30-40
Bread *	2	180-190	50-60
White bread *	2	180-190	50-60
Buckwheat bread *	2	180-190	50-60
Whole grain bread *	2	180-190	50-60
Rye bread *	2	180-190	50-60
Spelt bread *	2	180-190	50-60
Walnut cake	2	180	55-60
Sponge cake *	2	160-170	25-30
Cheesecake	2	170-180	65-75
Cupcakes	2	170-180	25-30
Small pastries made with yeast dough	2	200-210	25-30
Cabbage pirozhki *	2	185-195	25-35
Fruitcake	2	150-160	40-50
Meringue cookies	2	90	120
Jelly-filled rolls (Buchtel)	2	170-180	30-35

Tip	Use
<b>Is the cake done?</b>	<ul style="list-style-type: none"> <li>• Pierce the cake at the top with a wooden toothpick or skewer. If there are no traces on the pick or the skewer when pulled out, the cake is done.</li> </ul>
<b>Did the cake collapse?</b>	<ul style="list-style-type: none"> <li>• Check the recipe.</li> <li>• Next time, use less liquid.</li> <li>• Note the mixing time when using small mixers, blenders etc.</li> </ul>
<b>The cake is too light at the bottom?</b>	<ul style="list-style-type: none"> <li>• Use a dark-coloured baking sheet or tray.</li> <li>• Place the baking sheet one guide lower and switch on the lower heater towards the end of the cooking progress.</li> </ul>
<b>Cake with moist stuffing is underdone?</b>	<ul style="list-style-type: none"> <li>• Increase temperature and extend baking time.</li> </ul>



**Do not insert the deep baking tray into the first guide.**

## LARGE GRILL, GRILL

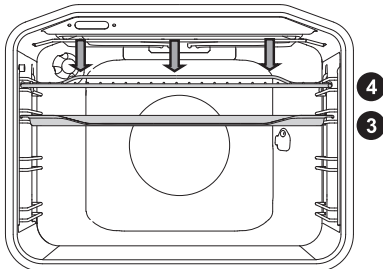

When grilling food with the large grill, the upper heater and the grill heater fitted on the ceiling of the oven cavity will operate.

When grilling food, the upper heater and the grill heater fitted on the ceiling of the oven cavity will operate.

Preheat the infrared (grill) heater for five minutes.

Supervise the cooking process at all times. The meat may burn quickly due to high temperature.

Roasting with the grill heater is suitable for crispy and low-fat cooking of bratwurst, cuts of meat and fish (steaks, escalopes, salmon steaks or fillets etc.) or toasted bread.

When grilling directly on the grid, smear it with oil to prevent the meat from sticking onto it and insert it into the 4th guide. Insert the drip tray in to the 1st or 2nd guide. When grilling in a baking tray, make sure there is enough liquid in the tray to prevent burning. Turn the meat during cooking.

After grilling, clean the oven, the accessories, and the utensils.

### Grilling table - small grill

Type of food	Weight (g)	Guide (from the bottom)	Temperature (°C)	Cooking time (minutes)
<b>MEAT</b>				
Beefsteak, rare	180 g / piece	3	220	18-21
Pork neck fillet	180 g / piece	3	220	18-22
Cutlets/chops	180 g / piece	3	220	20-22
Grill sausages	100 g / piece	3	220	11-14
<b>TOASTED BREAD</b>				
Toast	/	4	220	3-4
Open sandwiches	/	4	220	5-7



## Grilling table - large grill

Type of food	Weight (g)	Guide (from the bottom)	Temperature (°C)	Cooking time (minutes)
<b>MEAT</b>				
Beefsteak, rare	180 g / piece	3	220	14-16
Beefsteak, well done	180 g / piece	3	220	18-21
Pork neck fillet	180 g / piece	3	220	19-23
Cutlets/chops	180 g / piece	3	220	20-24
Veal escalope	180 g / slice	3	220	19-22
Grill sausages	100 g / piece	3	220	11-14
Spam (Leberkäse)	200 g / piece	3	220	9-15
<b>FISH</b>				
Salmon steaks/fillets	600	3	220	19-22
<b>TOASTED BREAD</b>				
6 slices of white bread	/	4	220	1.5-3
4 slices of mixed grain bread	/	4	220	2-3
Open sandwiches	/	4	220	3.5-7

Always keep the oven door closed when using the grill (infrared) heater.

Grill heater, grid, and other oven accessories get very hot during grilling. Therefore, use oven mitts and meat tongs.



**Always keep the oven door closed when using the grill (infrared) heater.**

**Grill heater, grid, and other oven accessories get very hot during grilling. Therefore, use oven mitts and meat tongs.**

## Cooking with the rotisserie (depending on the model)

Maximum temperature when using the rotisserie is 240°C.

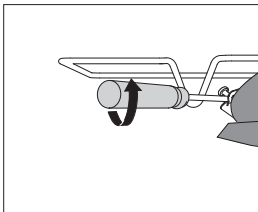
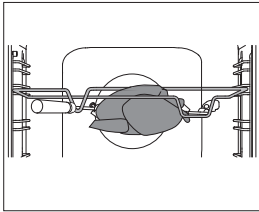
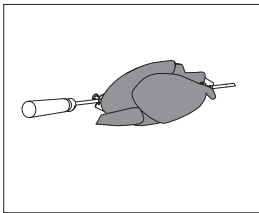
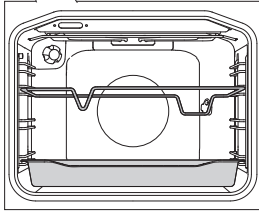
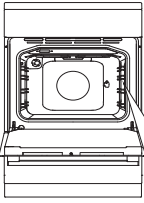

**1** Insert the skewer support into the 3rd guide from the bottom and place the deep tray into the bottom (1st) guide to serve as a drip tray.

**2** Impale the meat on the skewer and tighten the screws.

**3** Place the skewer handle on the front skewer support and insert the tip into the opening in the right hand side of the rear oven cavity wall (the opening is protected with a rotating cover).

**4** Undo the skewer handle and close the oven door.

Switch on the oven and select the LARGE GRILL system.



**The grill will only operate when the oven door is closed.**

## GRILL WITH FAN

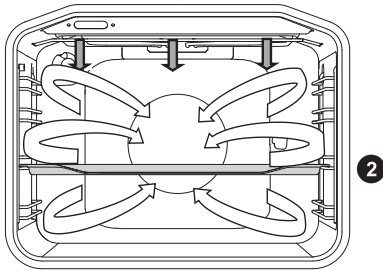

The bottom heater, the round heater, and the hot air fan will operate. Suitable for baking pizzas, apple pies, and fruitcakes.

2 (See descriptions and tips for UPPER and BOTTOM HEATER.)

Type of food	Weight (g)	Guide level (from the bottom)	Temperature (°C)	Cooking time (min)
<b>MEAT</b>				
Duck *	2000	2	150-170	80-100
Pork roast	1500	2	160-170	60-85
Pork shoulder	1500	2	150-160	120-160
Pork shank	1000	2	150-160	120-140
Half of chicken	600	2	180-190	25 (one side) 20 (other side)
Chicken*	100	2	190	30 (one side) 30 (other side)
<b>FISH</b>				
Trout	200g/piece	2	170-180	45-50

## HOT AIR AND BOTTOM HEATER

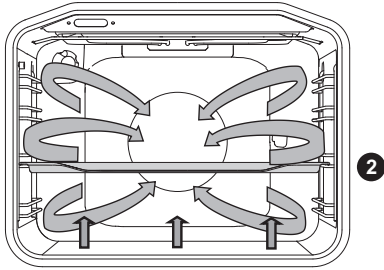

The bottom heater, the round heater, and the hot air fan will operate. Suitable for baking pizzas, apple pies, and fruitcakes.

2 (See descriptions and tips for UPPER and BOTTOM HEATER.)

Food	Guide (from the bottom)	Temperature (°C)	Cooking time (minutes)
Cheesecake, short crust	2	150-160	65-80
Pizza *	2	200-210	15-20
Quiche Lorraine, shortcrust	2	180-200	35-40
Apple pie, leavened dough	2	150-160	35-40
Apple strudel, phyllo dough	2	170-180	45-65

## HOT AIR

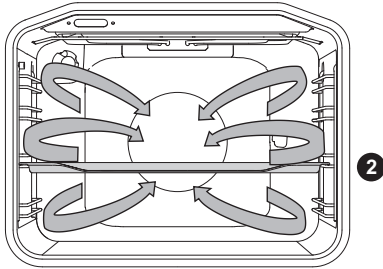

Round heater and the fan will operate. The fan installed in the back wall of the oven cavity makes sure the hot air constantly circulates around the roast or pastry.

### Roasting meat:

Use enamel coated, tempered glass, clay, or cast iron pan or tray. Stainless steel trays are not suitable as they strongly reflect the heat.

Provide enough liquid during the cooking process to prevent the meat from burning. Turn the meat during roasting. The roast will remain juicier if you cover it.

Food	Weight (g)	Guide (from the bottom)	Temperature (°C)	Cooking time (minutes)
<b>MEAT</b>				
Pork roast, including skin	1500	2	170-180	140-160
Pork belly	1500	2	170-180	120-150
Duck	1700	2	160-170	120-150
Goose	4000	2	150-160	180-200
Turkey	5000	2	150-170	180-220
Chicken breast	1000	2	180-190	70-85
Stuffed chicken	1500	2	170-180	100-120

## Baking pastry

Preheating is recommended.

Biscuits and cookies can be baked in shallow baking sheets on several levels simultaneously (2nd and 3rd).

Note that baking time can differ even with if the baking sheets used are the same. The biscuits in the upper baking sheet may be ready sooner than those in the lower one.

Always place the baking trays on the grid. If you are using the supplied baking sheet, remove the grid.

For even browning, make sure the biscuits are of the same thickness.

Food	Guide (from the bottom)	Temperature (°C)	Cooking time (minutes)
<b>PASTRY</b>			
Cake	2	150-160	45-60
Sponge cake	2	150-160	25-35
Crumble cake	2	160-170	25-35
Fruit cake, sponge	2	150-160	45-65
Plum cake	2	150-160	30-40
Sponge roll*	2	160-170	15-25
Fruit cake, short crust	2	160-170	50-70
Challah (braided yeast bun)	2	160-170	35-50
Apple strudel	2	170-180	40-60
Biscuits, short crust	2	150-160	15-25
Biscuits, pressed *	2	150-160	10-20
Cookies, leavened	2	170-180	20-35
Cookies, phyllo dough	2	170-180	20-30
Yoghurt	2	40	240
<b>PASTRY - FROZEN</b>			
Apple and cottage cheese strudel	2	170-180	50-70
Pizza	2	170-180	20-30
Fried potatoes, oven-ready	2	170-180	20-35
Croquettes, oven-baked	2	170-180	20-35
Cream-filled pastry	2	180-190	25-45



**Do not insert the deep baking tray into the first guide.**



## BOTTOM HEATER AND FAN

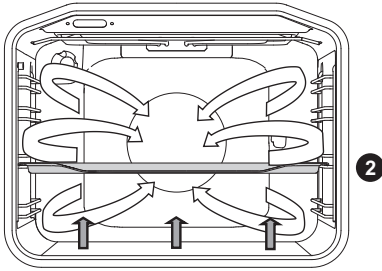

This is used for baking leavened but low-rising pastry and for preserving fruit and vegetables. Use the second guide from the bottom and a rather shallow baking tray to allow the hot air to circulate across the upper side of the dish.

Type of food	Guide (from the bottom)	Temperature	Cooking time (minutes)
<b>FRUIT</b>			
Strawberries	2	180	20-30
Stone fruits	2	180	25-40
Fruit mush	2	180	25-40
<b>VEGETABLES</b>			
Pickled gherkins	2	180	25-40
Beans/carrots	2	180	25-40

## PRESERVATION

Prepare the food to be preserved and jars as usual. Use jars with a rubber sealing ring and a glass cover. Do not use jars with threaded or metal caps or metal tins. Make sure the jars are of equal size, filled with the same contents, and tightly sealed.

Pour 1 litre of hot water into the deep tray (approx. 70°C) and place 6 1-litre jars into the tray. Place the tray into the oven on the second guide.

During preservation, observe the food and cook until the liquid in the jars starts to simmer – when bubbles appear in the first jar.

Food	Amount (L)	T = 170 °C - 180 °C until bubbles appear in the jars / until liquid in the jars starts to simmer	Temperature at the start of simmering - when bubbles appeared	Resting time in the oven (min)
<b>FRUIT</b>				
Strawberries	6×1 l	40-55	switch off	25
Stone fruits	6×1 l	40-55	switch off	30
Fruit mush	6×1 l	40-55	switch off	35
<b>VEGETABLES</b>				
Pickled gherkins	6×1 l	40-55	switch off	30
Beans, carrots	6×1 l	40-55	120°C, 60min	30





## DEFROSTING

In this mode, the air will circulate without any heaters operating.

Food suitable for defrosting includes cakes with heavy cream or butter-based cream, cakes and pastry, bread and rolls, and deep-frozen fruit.

In most cases, it is recommended to remove the food from the packaging (do not forget to remove any metal clamps or clips).

Halfway through the defrost time, the pieces should be turned over, stirred and separated if they were frozen together.

# MAINTENANCE & CLEANING



Be sure to unplug the appliance from the power supply and wait for the appliance to cool down.

Children should not clean the appliance or perform maintenance tasks without proper supervision.

## Aluminium finish

Clean the aluminium finish with non-abrasive liquid cleaners intended for such surfaces. Apply the cleaner onto a wet cloth and clean the surface. Then, rinse the surface with water. Do not apply the cleaner directly onto the aluminium finish.

Do not use abrasive cleaners or sponges.

Note: The surface should not come into contact with oven cleaning sprays as this may result in visible and permanent damage.

## Stainless steel sheet front side of the housing

(depending on the model)

Clean this surface only with a mild detergent (soapsuds) and a soft sponge that will not scratch the finish. Do not use abrasive cleaners or cleaners containing solvents as they may damage the housing finish.

## Lacquer-coated surfaces and plastic parts

(depending on the model)

Do not clean the knobs and buttons, door handles, stickers, and rating/type plates with abrasive cleaners or abrasive cleaning materials, alcohol-based cleaners, or with alcohol. Immediately remove any stains with a soft non-abrasive cloth and some water, in order to avoid damaging the surface.

You may also use cleaners and cleaning materials intended for such surfaces as instructed by their respective manufacturers.

## Control unit

Do not clean the surface with abrasive cleaners or harsh cleaning tools.



The aluminium-coated surfaces should not come into contact with oven cleaning sprays as this may result in visible and permanent damage.

# CLEANING THE COOKING HOBS

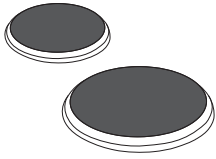

Clean the area around the cooking zones with hot water and some washing-up liquid.

For stubborn dirt, use a steel wool pad soaked with detergent; then, rinse the hob and wipe it dry.

Liquids containing salt, boiled-over liquids and moisture have detrimental effect on the cooking zones. Always clean the cooking zones,

Use regular cleaners and commercially available conditioners to maintain the cooking zones. If the cooking zone is slightly warm, the cleaner will penetrate the pores more readily.

Cooking zone rings are made of stainless steel. Because exposure to heat, they may take on a yellowish hue after a certain period of use. This is a normal physical phenomenon. The yellowish spots may be removed with regular metal cleaners. Aggressive dishwashing accessories are not suitable for cleaning of these rims, as they may cause scratches.

## GAS BURNER

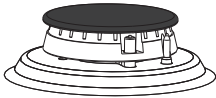

The grid, cooking surface, and burner parts may be cleaned in hot water with some washing up detergent. Do not clean them in a dishwasher.

Clean the thermocouple and the spark plug with a soft brush.

These parts have to be spotlessly clean to function correctly.

Clean the burner crown and cap. Make sure the slots on the burner crown are not clogged or otherwise blocked. After cleaning, thoroughly dry all the parts and reassemble them correctly. Any part placed askew will make burner ignition harder.



Burner caps are finished in black enamel. Due to high temperatures, discoloration cannot be avoided. However, it does not affect burner operation.

# CONVENTIONAL OVEN CLEANING

You may use the standard cleaning procedure to clean stubborn dirt in the oven (using cleaners or an oven spray). After such cleaning, rinse the cleaner residues thoroughly.

Clean the oven and the accessories after each use to prevent the dirt from burning into the surface. The easiest way to remove fat is by using warm soapsuds while the oven is still warm.

With stubborn dirt and grime, use conventional oven cleaners. Rinse the oven thoroughly with clean water to remove all cleaner residue.

Never use aggressive cleaners, abrasive cleaners, abrasive sponges, stain and rust removers etc.

Clean the accessories (baking sheets and trays, grids etc.) with hot water and detergent.

The oven, the oven cavity and the baking trays are lined with a special enamel coating for a smooth and resistant surface. This special coating makes cleaning at room temperature easier.

# USING THE AQUA CLEAN FUNCTION TO CLEAN THE OVEN

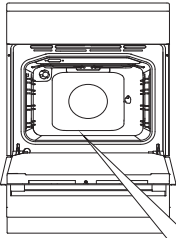

**1** Turn the COOKING SYSTEM SELECTOR KNOB to Aqua Clean. 2. Set the TEMPERATURE KNOB to 70 °C.

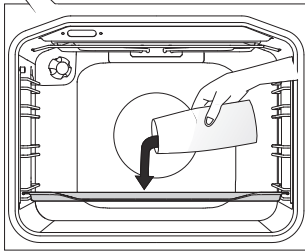

**2** Pour 0.6 l water into the deep baking tray and place it in the lower guide

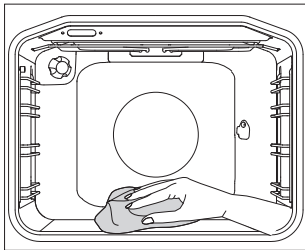

**3** After 30 minutes, food residues on the oven enamel walls will have softened and they will be easy to clean with a damp cloth.



Use the Aqua Clean system when the oven has fully cooled down..

# REMOVING AND CLEANING WIRE AND TELESCOPIC EXTENDIBLE GUIDES

Only use conventional cleaners to clean the guides.

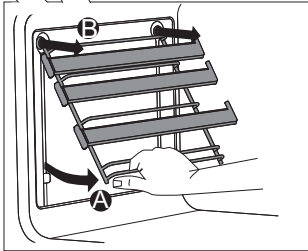
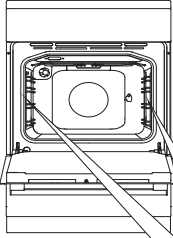

**A** Hold the guides by the bottom side and pull them towards the center of the oven cavity.

**B** Remove them from the openings at the top.

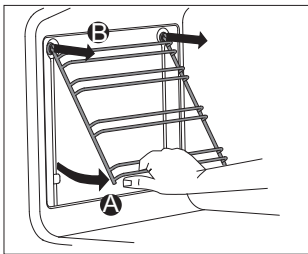

Do not clean the extendible guides in the dishwasher.

# INSTALLING THE CATALYTIC INSERTS

Only use conventional cleaners to clean the guides.

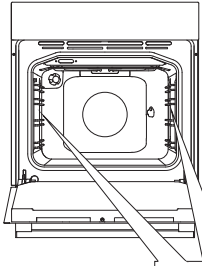

Remove the wire guides or extendible guides.

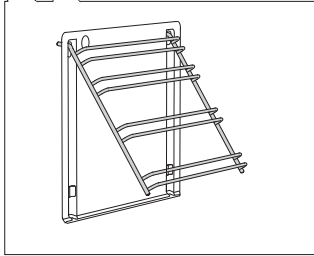

**1** Mount the guides onto the catalytic insert.

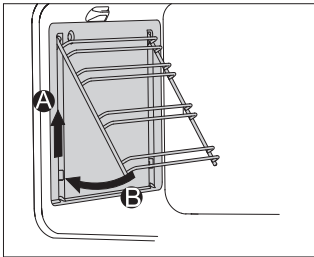

**2** Hang the inserts with guides attached using the holes provided, and pull upwards.

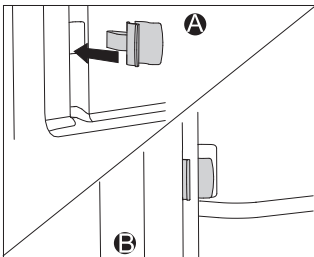

When installing fully extendible guides with catalytic inserts, insert one end of the supplied snap locks into the openings at the bottom of the oven cavity wall and insert the other end of the snap locks into the guides.

The purpose of the snap locks is to hold the guides in place more firmly.



**Do not wash the catalytic inserts in the dishwasher.**

# CLEANING THE OVEN CAVITY CEILING

(depending on the model)

Upper grill heater is foldable to allow easier cleaning of the oven cavity ceiling. Before cleaning the oven, remove the trays, the grid, and the guides.

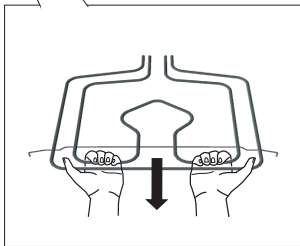
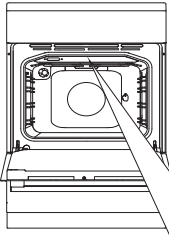

Pull the heater until the cross bar is released from the supports on the left and right hand side of the oven cavity.

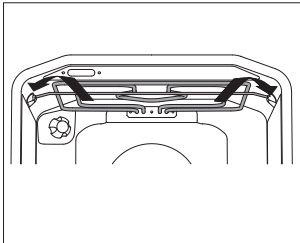

.....  
 Never use the heater when folded/ lowered. After cleaning, observe the same procedure in the reverse order to push back the heater until the cross bar snaps back into place.

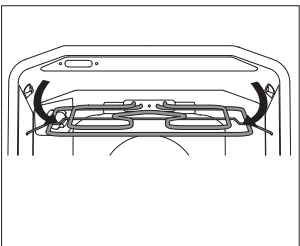

**Disconnect the appliance from the power mains.**

**The heater must be cool; otherwise, there is danger of burns.**



# REMOVING AND INSERTING THE OVEN DOOR

(depending on the model)

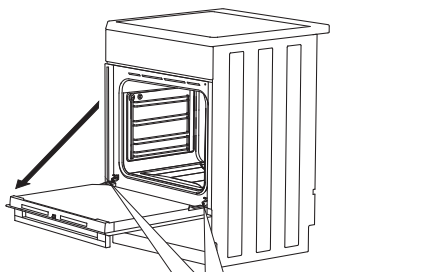

**1** First, fully open the door (as far as it will go).

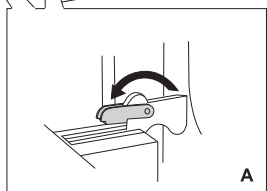

**2** **A** Rotate the stoppers all the way back (in case of conventional closing).

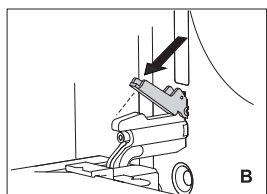

**B** With soft closing system, rotate the stoppers back by 90°.

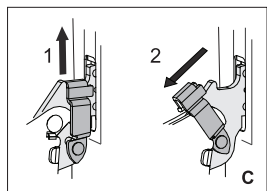

**C** If the appliance is fitted with the GentleClose system, slightly lift the door latches and pull them towards you.

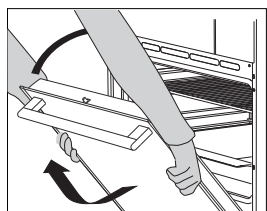

**3** Slowly close the door until the latches are aligned with the slots. Slightly lift the door and pull it out from both hinge slots on the appliance.

To replace the door, follow the reverse order. If the door does not open or close properly, make sure the notches on the hinges are aligned with the hinge beds.

## **SOFT DOOR CLOSING** (depending on the model)

Oven door is fitted with a system that dampens the door closing force, starting at the 75-degree angle. It allows simple, quiet, and smooth closing of the door. A gentle push (to a 15-degree angle relative to the closed door position) is enough for the door to close automatically and softly.



**If the force applied to close the door is too strong, the effect of the system is reduced or the system will be bypassed for safety.**

## **DOOR LOCK** (depending on the model)

Open the door lock by gently pushing it to the right with your thumb while simultaneously pulling the door outwards.



**When the oven door is closed, the door lock automatically returns to the initial position.**



**When replacing the door, always make sure the hinge retainers are correctly placed in the hinge beds to prevent sudden closing of the main hinge which is connected to a strong main spring. If the main spring is engaged, there is a risk of injury.**

# REMOVING AND INSERTING THE OVEN DOOR GLASS PANE

Oven door glass pane can be cleaned from the inside, but it has to be removed first. Remove the oven door (see chapter "Removing and replacing the oven door").

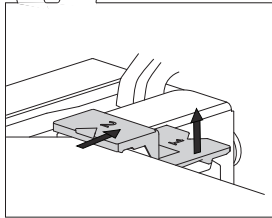
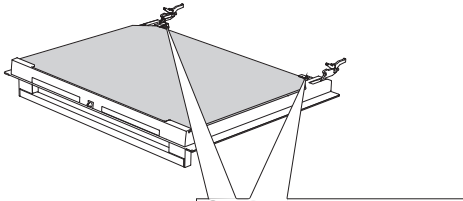

**1** Slightly lift the supports on the left and right side of the door (marking 1 on the support) and pull them away from the glass pane (marking 2 on the support).

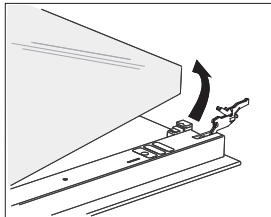

**2** Hold the door glass pane by the lower edge; slightly lift it so that it is no longer attached to the support; and remove it.

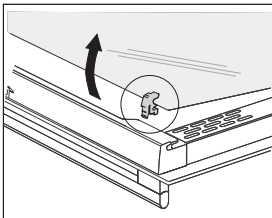

**3** To remove the third glass pane (only with some models), lift and remove it. Also remove the rubber seals on the glass pane.



To replace the glass pane, observe the reverse order. The markings (semicircle) on the door and the glass pane should overlap.

# REPLACING THE BULB

The bulb is a consumable and therefore not covered by warranty. Before changing the bulb, remove the trays, the grid, and the guides.

Use a Phillips (cross) screwdriver.

(Halogen lamp: G9, 230 V, 25 W; regular bulb E14, 25 W, 230 V)

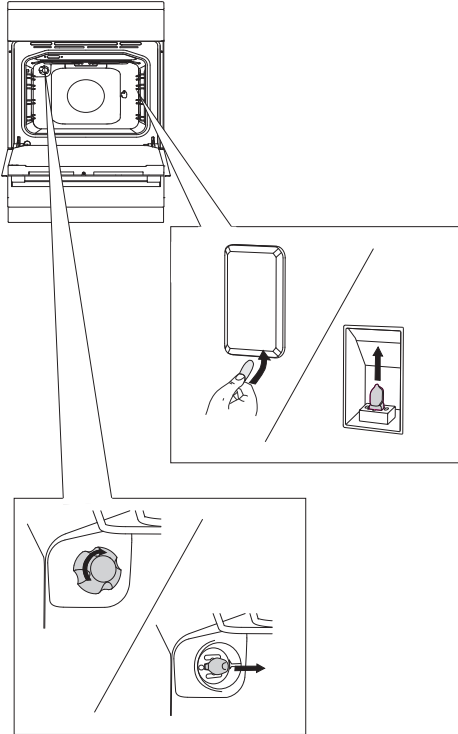

Use a flat screwdriver to release the bulb cover and remove it. Remove the bulb.

💡 Be careful not to damage the enamel.

.....  
Undo the bulb cover and remove the bulb.

💡 Use protection to avoid burs.

# TROUBLESHOOTING TABLE









Problem/error	Cause
<b>There is no response of the sensors; the display is frozen.</b>	Disconnect the appliance from the power mains for a few minutes (undo the fuse or switch off the main switch); then, reconnect the appliance and switch it on.
<b>The main fuse in your home trips often.</b>	Call a service technician.
<b>The oven lighting does not work.</b>	The process of changing the light bulb is described in the chapter Cleaning and Maintenance.
<b>The pastry is underdone.</b>	Did you choose the right temperature and heating system? Is the oven door closed?
<b>The burners do not burn evenly.</b>	Have an expert check the gas settings.
<b>Burner flame suddenly changes; the knob has to be depressed longer to ignite the burner.</b>	Make sure the burner is assembled correctly.
<b>The flame is extinguished after ignition.</b>	Hold the knob depressed for a longer period of time. Before releasing the knob, press it harder.
<b>There is discolouration on the grid in the burner area.</b>	This is a normal phenomenon resulting from high temperature. Clean the grid with a metal cleaner.
<b>Electric burner ignition no longer works; the caps ...</b>	Carefully clean the opening between the spark plug and the burner. Clean the burner caps with a metal cleaner. Place the burner cover correctly.

If the problems persist despite observing the advice above, call an authorized service technician. Repair or any warranty claim resulting from incorrect connection or use of the appliance shall not be covered by the warranty. In this case, the user will cover the cost of repair.

# COOKING TEST

Food tested in compliance with the EN 60350-1 standard.

## Conventional baking

Dish	Equipment	Guide (from the bottom)	System	Temperature (°C)	Cooking time (minutes)
Cookies – single level	Shallow enamel-coated baking sheet	3		140-150 *	25-40
Cookies – two levels	Shallow enamel-coated baking sheet	2, 3		140-150 *	30-45
Cookies – three levels	Shallow enamel-coated baking sheet	2, 3, 4		130-140 *	35-50
Cupcakes – single level	Shallow enamel-coated baking sheet	3		150-160	25-40
Cupcakes – two levels	Shallow enamel-coated baking sheet	2, 3		140-150	30-45
Cupcakes – three levels	Shallow enamel-coated baking sheet	2, 3, 4		140-150	35-50
Cake	Round metal mould/ Wire shelf (support grid)	2		160-170	20-35
Apple pie	Round metal mould/ Wire shelf (support grid)	2		170-180	55-75

\* Preheat for 10 minutes. Do not use fast preheat function.

## Grill

Dish	Equipment	Guide (from the bottom)	System	Temperature (°C)	Cooking time (minutes)
Toast	Wire shelf/ grid	4	▼▼▼	240 *	1:00-5:00
Minced meat patty (pljeskavica)	Wire shelf (support grid) + shallow baking sheet as drip tray	4	▼▼▼	240	30-40 **

\* Preheat for 6 minutes. Do not use fast preheat function.

\*\*Turn after 2/3 of total cooking time.

# INSTALLATION AND CONNECTION INSTRUCTIONS

## APPLIANCE PLACEMENT

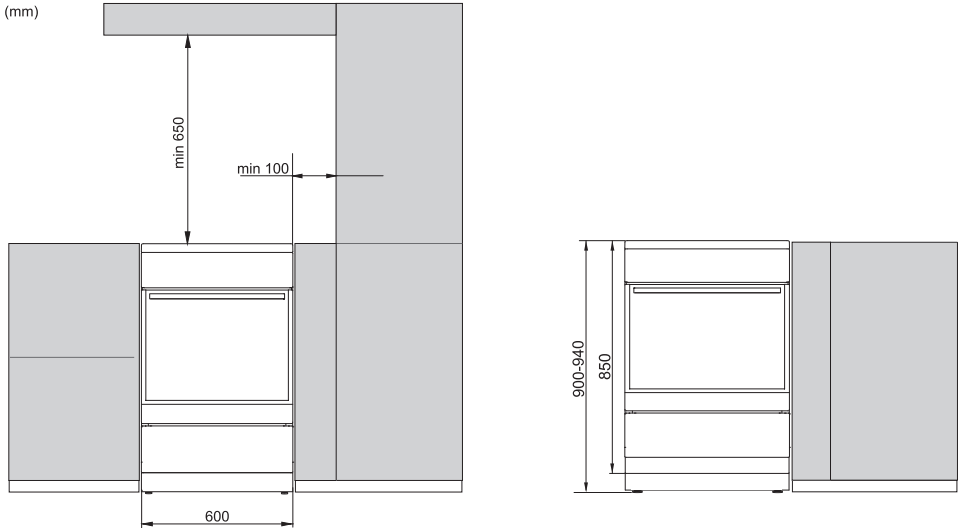

The walls or furniture adjacent to the appliance (floor, rear kitchen wall, side walls) have to be temperature-resistant to at least 90 °C.

## LEVELLING THE APPLIANCE AND ADDITIONAL SUPPORT

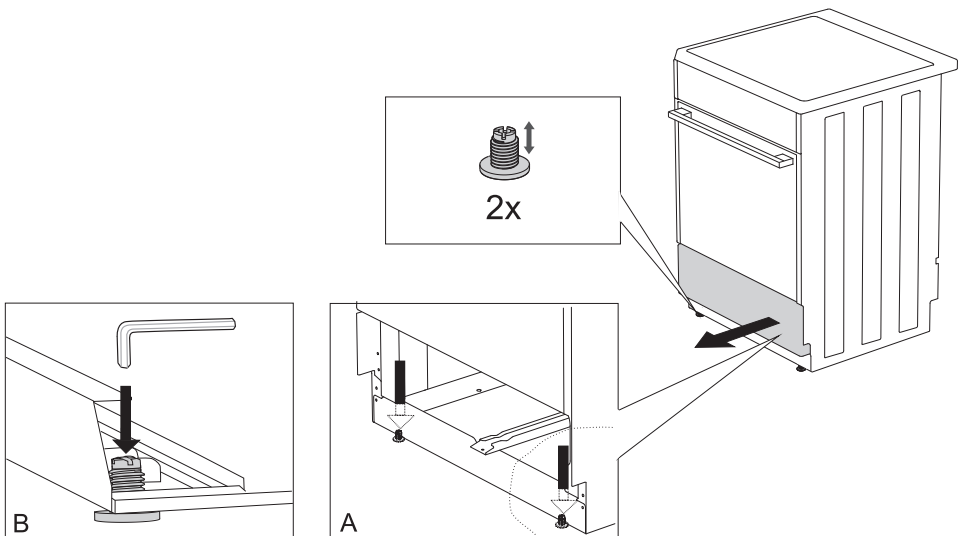



## PREVENTION FROM TIPPING OVER

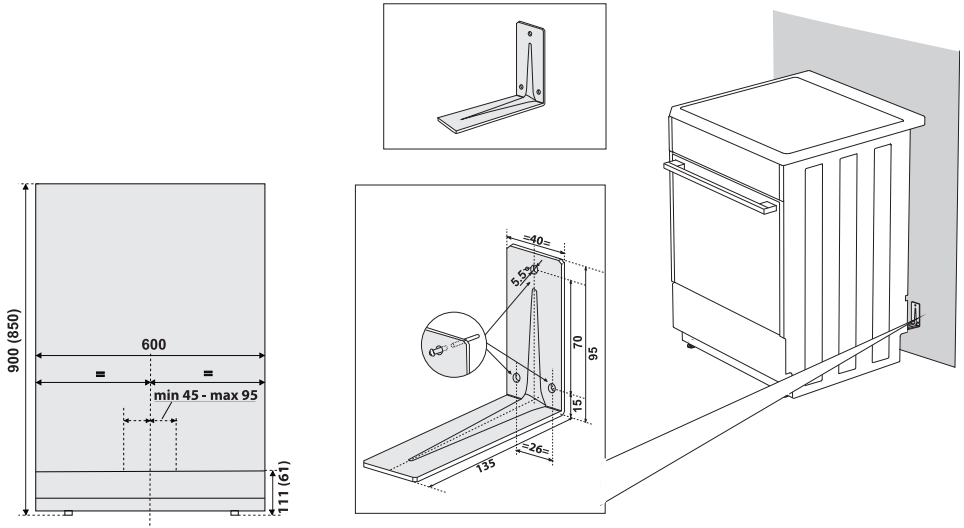

 Dimensions in the parenthesis represent built-in measures of the support bracket without the additional support. If the supplied element protecting the appliance from tipping over cannot be firmly secured to your wall with the screws and the wall plugs supplied, use other fittings to secure the bracket in such way that it cannot be pulled out from the wall.

# CONNECTING TO THE POWER MAINS

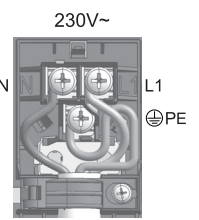
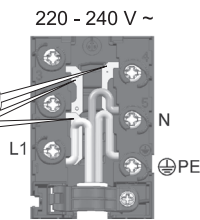
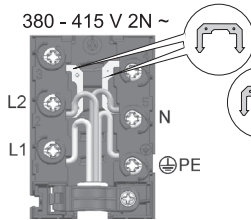
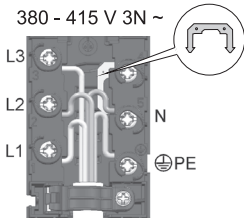
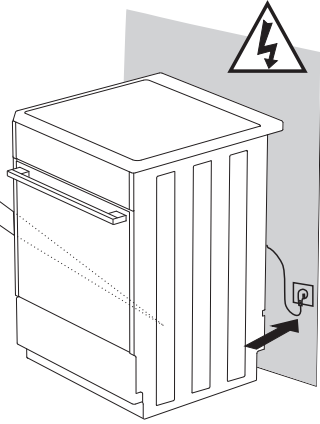
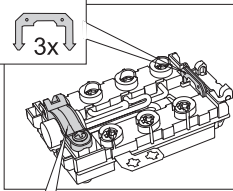
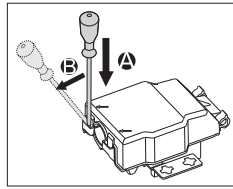
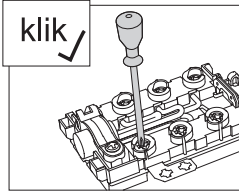

# GAS CONNECTIONS

## FACTORY DEFAULT SETTINGS

- Gas appliances are tested and fitted with the CE sign.
- Has appliances are supplied sealed with burners adjusted to natural gas type H or E (20 mbar), or to liquefied natural gas (50 or 30 mbar).

The information is provided on the appliance rating plate found on the interior of the oven. It is visible when the oven door is opened.

- Before connecting the appliance, make sure the local requirements for connection (gas type and pressure) are compatible with the appliance settings.

If the gas you are using is not compatible with the current settings on your appliance, call a service technician or the distributor.

- Modifying the hob to operate with a different type of gas requires replacement of the nozzles (see section NOZZLE TABLE).
- In case of repairs or if the seal is damaged, the functional parts have to be tested and re-sealed in compliance with the installation instructions. The functional parts include the following: fixed nozzle for large flame and adjustable regulation screw for small flame.

## CONNECTING TO GAS SUPPLY

- Appliance has to be connected to the gas mains or the gas cylinder according to the instructions of your local gas distribution company.
- There is a gas connection plug on the right-hand side of the appliance, with external thread EN ISO 10226-1 / -2 or EN ISO 228-1 (depending on the connection regulations in the respective country).
- A liquefied natural gas connection and a non-metal gasket are also supplied.
- When connecting the appliance to the gas supply, the R 1/2 part has to be held to prevent it from rotating.
- Use approved non-metal gaskets and approved sealants for sealing the connection joints. Only use each gasket once. The thickness of flat non-metal gaskets may be deformed by up to 25%.
- Connect the appliance to the gas supply using a certified flexible hose. The hose should not touch the lower appliance wall, the back wall or the oven ceiling.

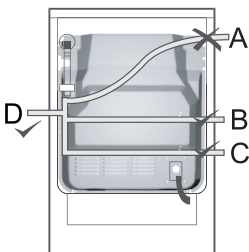

### Connection with a flexible hose

If the appliance is connected with a flexible hose, the path of the hose indicated with "A" is not acceptable.

If a metal pipe is used, option A is permissible as well.

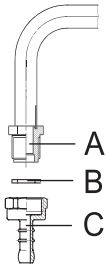

### Gas connection plug

- A** Connection EN ISO 10226-1 / -2 or EN ISO 228-1 depending on the connection regulations in the respective country).
- B** Non-metal gasket, thickness 2 mm
- C** Hose plug for liquefied natural gas (depending on the connection regulations in the respective country)

After connection, check the operation of the burners. The flames have to burn with clearly visible blue and green core. If the flame is unstable, increase the minimum power as necessary. Explain to the user how the burners operate and review the instruction manual together.



After connecting the appliance, check the seal on all joints.

### MODIFYING THE BURNERS FOR USE WITH A DIFFERENT TYPE OF GAS

- Modifying the burners for use with a different type of gas does not require removing the hob from the countertop.
- Before making the modifications, unplug the appliance from the power mains and shut off the gas supply valve.
- Replace the existing nozzle for the nominal heat load with suitable nozzles for the new type of gas (see table).
- When modifying the appliance for use with liquefied natural gas, tighten the minimum heat load regulation screw all the way to reach the minimum heat load.
- When modifying the appliance for use with natural gas, undo the minimum heat load regulation screw to reach the minimum heat load, but by no more than 1.5 turns.

**After modifying the appliance** for use with a different type of gas, replace the old sticker with gas type information (on the rating plate) with the relevant new sticker and test the functionality and sealing of the appliance.

Make sure the electric conductors, thermostat capillary, and thermo elements do not protrude into the gas flow area.

### ADJUSTMENT ELEMENTS

- Adjustment elements for minimum heat load of the burners are accessible through the openings on the control panel.
- Remove the support grid, burner caps, and burner crowns.
- Remove the control knobs.

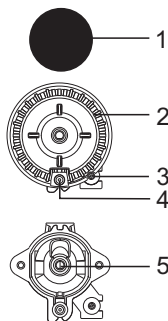

### Cooking burner

1. Burner crown cap
2. Burner crown with burner cap support
3. Thermo element (only with some models)
4. Spark plug
5. Nozzle

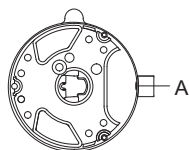

### Triple (three-ring) burner

- A Nozzle

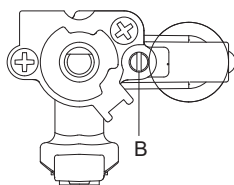

### Gas valve with a safety device

- B Minimum heat load regulation screw

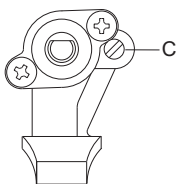

### Gas valve without a safety device

- C Minimum heat load regulation screw

# NOZZLE TABLE

Gas type, pressure		Auxiliary burner				Normal burner	
Wobe number		Standard		Rapid			
		max	min	max	min	max	min
<b>Natural gas H</b> Wo=45,7÷54,7 MJ/ m <sup>3</sup> , <b>Natural gas E,</b> <b>Natural gas E+</b> Wo=40,9÷54,7 MJ/m <sup>3</sup> G20, p=20mbar	Nominal heat load (kW)	1	0,36	1	0,36	1,90	0,46
	Consumption (l/h)	95,21	34,4	95,21	34,4	180,9	43,8
	Nozzle type (1/100 mm)	77	-	78	-	104	-
	Nozzle ID	162081		162082		162083	
<b>Liquefied gas</b> 3+, B/P Wo=72,9÷87,3MJ/m <sup>3</sup> G30 p=30 mbar	Nominal heat load (kW)	1	0,36	1	0,36	1,90	0,46
	Consumption (g/h)	71,7	26,2	71,7	26,2	138,1	33,4
	Nozzle type (1/100 mm)	50	24	50	24	69	26
	Nozzle ID	162162		162162		162164	

Gas type, pressure		Large burner		Triple (three-ring) burner	
Wobe number					
		max	min	max	min
<b>Natural gas H</b> Wo=45,7÷54,7 MJ/ m <sup>3</sup> , <b>Natural gas E,</b> <b>Natural gas E+</b> Wo=40,9÷54,7 MJ/m <sup>3</sup> G20, p=20mbar	Nominal heat load (kW)	3	0,76	3,5	1,56
	Consumption (l/h)	285,64	72,4	333,2	148,5
	Nozzle type (1/100 mm)	129	-	140	•
	Nozzle ID	162084		162085	
<b>Liquefied gas</b> 3+, B/P Wo=72,9÷87,3MJ/m <sup>3</sup> G30 p=30 mbar	Nominal heat load (kW)	3	0,76	3,5	1,56
	Consumption (g/h)	215,0	55,3	254,5	113,4
	Nozzle type (1/100 mm)	87	33	93	57
	Nozzle ID	162165		162166	

- Regulation screws for liquefied gas are installed and set in factory to the gas type for which the factory default settings apply.
- When modifying the appliance for use with a different type of gas, the regulation screw has to be tightened or undone to set the required gas flow (do not undo the regulation screw by more than 1.5 turns).

Burner power is indicated by observing the upper Hs caloric value.



**These tasks may only be carried out by an expert authorized by the gas distribution company or an authorized service center.**

# DISPOSAL

---



Packaging is made of environmentally friendly materials that can be recycled, disposed of, or destroyed without any hazard to the environment. To this end, packaging materials are labelled appropriately.

The symbol on the product or its packaging indicates that the product should not be treated as normal household waste. The product should be taken to an authorized collection center for waste electric and electronic equipment processing.

Correct disposal of the product will help prevent any negative effects on the environment and health of people which could occur in case of incorrect product removal. For detailed information on removal and processing of the product, please contact the relevant municipal body in charge of waste management, your waste disposal service, or the store where you bought the product.

*We reserve the right to any changes and errors in the instructions for use.*

[www.gorenje.com](http://www.gorenje.com)

# INFINITY

