

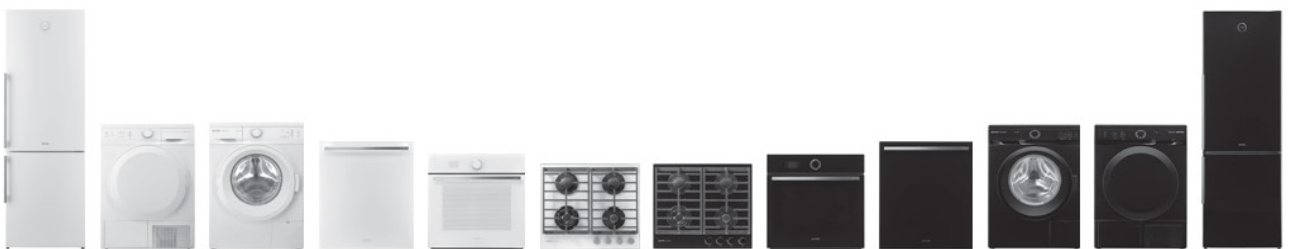

# en Instructions for use



**SERIAL NUMBER**



**Dear customer!**

This electric integrated gas hotplate cooker is manufactured for household use. Our appliances are packed in the environmentally friendly materials which may be recycled, deposited or destroyed without any hazard to the environment. Such packaging materials are also labeled accordingly. Once the life cycle your appliance is over, make sure not to pollute the environment, and deliver it to the authorized collectors of old household appliances.

**Instructions for use**

Instructions for use have been prepared for the user, and describe the appliance and the way it is handled. These instructions are intended for various types of appliances, so you may find some descriptions for the functions that your particular appliance may not have.

These instructions are only valid if the country symbol is indicated on the appliance. If there is NO country symbol in the appliance, technical instructions should be observed for adapting the appliance to comply with the requirements and regulations for use in your country.

**Instructions for connection**

The appliance must be connected in compliance with the instructions attached to it, as well as in compliance with relevant regulations and standards. The connection may only be performed by a qualified person.

**Rating plate**

The rating plate indicating the basic information on the appliance is attached to the lower side of the hob.

**Safety warnings**

DO NOT USE OR STORE FLAMMABLE MATERIALS IN OR NEAR THIS APPLIANCE

DO NOT SPRAY AEROSOLS IN THE VICINITY OF THIS APPLIANCE WHILE IT IS IN OPERATION.

WHERE THIS APPLIANCE IS INSTALLED IN MARINE CRAFT OR IN CARAVANS, IT SHALL NOT BE USED AS A SPACE HEATER.

DO NOT MODIFY THIS APPLIANCE

DO NOT PLACE ARTICLES ON OR AGAINST THIS APPLIANCE

Important warnings	4
Installation	5
Connecting to the power mains	6
Connecting to the gas supply	7
Technical information	9
Operation	11
Cleaning and maintenance	12
Problem solving guide	14

## TECHNICAL INSTRUCTIONS AND INSTALLATION

### Important warnings

- Installation of the appliance (installation class:3) into a kitchen worktop and its connection to the power mains and the gas supply may only be performed by an adequately qualified technician.
- When the appliance is in use, additional heat and moisture are emitted into the room. When the appliance is used for a prolonged period of time at a high performance level, intensive ventilation or use of kitchen hood may be required in the room where the appliance is installed.
- Do not use the gas burners, if the flame seems unstable.
- If you smell gas in the room, immediately close the gas supply valve either on the gas bottle or gas pipeline, extinguish all sources of open fire (including cigarettes), aerate the room, do not turn on any electric appliances, and call a natural gas expert.
- The main gas supply valve should also be closed if gas burners will be out of use for a long period of time (e.g. when going on holiday).
- The appliance and its accessible parts become hot during use. Care should be taken to avoid touching heating elements. Children less than 8 years of age shall be kept away unless continuously supervised.  
Prevent the children to hang around the appliance and warn them properly against the danger of burns.
- This appliance can be used by children aged from 8 years and above, and persons with reduced physical, sensory or mental capabilities or lack of experience and knowledge if they have been given supervision or instruction concerning use of the appliance in a safe way and understand the hazards involved. Children shall not play with the appliance. Cleaning and user maintenance shall not be made by children without supervision.
- **WARNING:** Unattended cooking on a hob with fat or oil can be dangerous and may result in fire. Be sure have the preparation of such food (fries) under constant control. Never try to extinguish a fire with water, but switch off the appliance and then cover flame e.g. with a lid or a fire blanket.
- **WARNING:** Danger of fire: do not store items on the cooking surfaces.
- **WARNING:** If the surface is cracked, switch off the appliance to avoid the possibility of electric shock.
- Do not use high-pressure steam cleaner or hot steam to clean the appliance.
- Never place any metal objects upon the hob surface, such as knives, forks, spoons, pot lids, and the like, as they may get very hot.
- The hob can not be activated by external timers or remote controls systems.
- Do not use the cooking hob for room heating.
- Do not place empty pans on the hob.
- Make sure that the parts of the burners are correctly positioned / installed.
- Hob surface should not be used as a worktop. Sharp objects may cause scratches.
- Preparing food in thin aluminum or plastic containers on hot cooking zones is not allowed. Do not place any plastic objects or aluminum foil on the hob surface.
- If there is a wall power outlet located near the hob and another appliance is plugged into it, make sure the power cord does not come into contact with the hot cooking zones.
- Do not store any temperature-sensitive objects, materials, or substances underneath the hob, e.g. detergents, sprays, etc.
- In case of a failure of the appliance, immediately disconnect the appliance from the power mains and contact the service center.
- The appliance is manufactured in compliance with the relevant effective safety standards.
- After a prolonged use of cast iron plates, the area of the plate and the edge of the cooking zone may discolour. Repair service is not covered by the warranty.
- Don't connect the hob to the power supply with an extension cable or multiple sockets, because they don't assure a sufficient safety (e.g. overheating risk of multiple sockets).
- Connect the equipment to a permanent connection.



**Don't use pan, pots, grills or grilled stones, of bigger size than the maximum specified for every single burner; in particular you must not cover more burners simultaneously. The accumulation of heat could damage the appliance.**



**The symbol on the product or on its packaging indicates that this product may not be treated as household waste. Instead it shall be handed over to the applicable collection point for the recycling of electrical and electronic equipment. By ensuring this product is disposed of correctly, you will help prevent potential negative consequences for the environment and human health, which could otherwise be caused by inappropriate waste handling of this product. For more detailed information about recycling of this product, please contact your local city office, your household waste disposal service or the shop where you purchased the product.**

## INSTALLATION

### Important warnings

This appliance must be installed by an authorised person in accordance with this instruction manual, AS/NZS 5601 – Gas installations (installation and pipe sizing), local gas fitting regulations, local electrical regulations, local water regulations, local health regulations, Building Code of Australia and any other government authority.

- Installation of the appliance into a kitchen worktop and its connection to the power mains may only be performed by an adequately qualified technician.
- Veneer or other finish of the piece of kitchen furniture into which the hob is to be built in should be treated with heat resistant glue (100°C); otherwise, the worktop finish may be discolored or deformed.
- Cooking hob is dimensioned to be built into the worktop over a piece of kitchen furniture, with a width of 600 mm or more.
- After installation, the front two fastening elements should be freely accessible from below.
- The kitchen furniture element underneath the hob should not be fitted with a drawer. If the kitchen furniture element as a horizontal partition wall, it should be installed no less than min 20mm from the lower surface of the worktop. The space between the partition wall and the hob must be empty; no objects should be placed into that gap.
- Hanging, or wall-mounted kitchen elements should be installed high enough not to interfere with the work process.
- The distance between the cooking hob and the kitchen hood should be no less than indicated in the instructions for kitchen hood installation. The minimum distance is 700 mm.
- The distance between the appliance edge and the adjacent tall kitchen furniture element should amount to no less than 150 mm.
- Use of massive wood decoration plates or boards on the worktops behind the cooking hob is permitted, if the minimum distance remains the same as indicated in the installation drawings.
- Minimum distance between the built-in cooking hob and the rear wall is indicated on the installation drawing.
- Cooking hobs can be installed into worktops that are 25 to 40 mm thick.

• **Only ovens fitted with a cooling fan may be installed underneath this cooking hob ①.**

• Before installing an oven, the rear wall of the kitchen furniture element should be removed in the area of the cooking hob cutout.

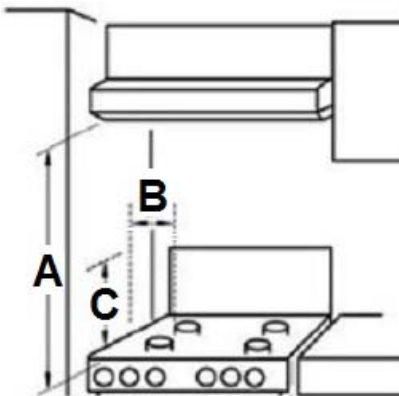

**Overhead clearances—(Measurement A)** Range hoods and exhaust fans shall be installed in accordance with the manufacturer's relevant instructions. However, in no case shall the clearance between the highest part of the hob of the gas cooking appliance and a range hood be less than 600 mm or, for an overhead exhaust fan, 750 mm.

**Side clearances—(Measurement B & C)** Where B, measured from the periphery of the nearest burner to any vertical combustible surface, or vertical combustible surface covered with toughened glass or sheet metal, is less than 200 mm, the surface shall be protected to a height C of not less than 150 mm above the hob for the full dimension (width or depth) of the cooking surface area. Where the gas cooking appliance is fitted with a „splashback“, protection of the rear wall is not required.

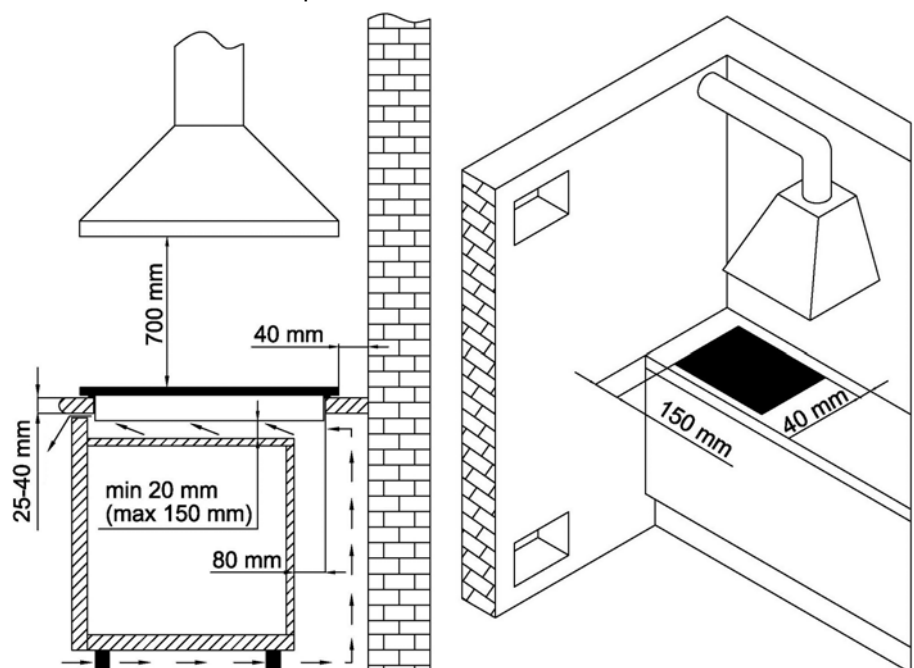
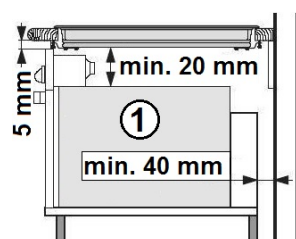
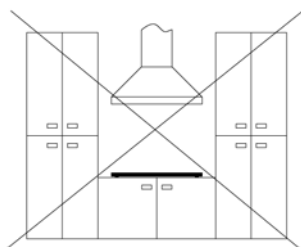

Gas inlet is located at the rear right 25mm from the edge.

	497502	497503
A (mm)	585	585
B (mm)	510	510
C (mm)	560	560
D (mm)	480	480
E (mm)	40	40
F (mm)	5	5
G (mm)	50	50

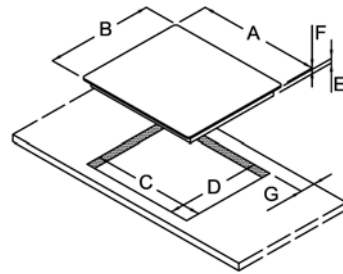

### Installing the foam gasket

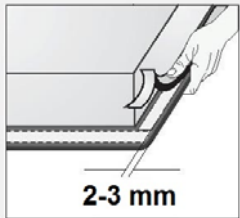

Before inserting the appliance into the opening in the kitchen worktop, the supplied foam gasket must be attached to the lower side of the glass ceramic (glass) cooking hob (see figure above).

**Do not install the appliance without the foam gasket!**

**The gasket should be attached to the appliance in the following way:**

- Remove the protective film from the gasket.
- Then, attach the gasket to the lower side of the glass, approximately 2-3 millimetres from the edge (as shown in the figure). The gasket must be attached along the entire length of the glass edge and should not overlap at the corners.
- When installing the gasket, make sure that the glass does not come into contact with any sharp objects.

### Installation procedure (with springs)

- Worktop must be placed absolutely horizontal.
- Suitably protect the edges of the cut aperture.
- Connect the cooking hob to the mains power supply (see instructions for the connection of the cooking hob to mains power supply).
- Put the supplied springs in their places.
- Insert the hob into the cut aperture.
- Press the hob firmly towards the worktop from above.

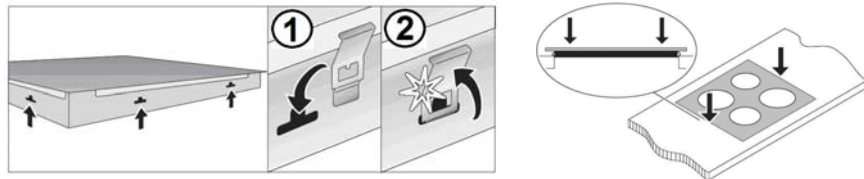

### Installation procedure (with fixing brackets)

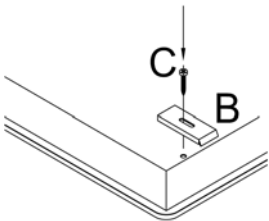

The cook top is fixed to the unit by means of the brackets and accessories provided. Holes are provided in the bottom of the tray where you can attach the screws C that hold the brackets B in place.

## CONNECTING TO THE POWER MAINS

- The appliance may only be connected by an authorized skilled technician.
- Electric system protection should comply with all relevant regulations.
- The connection clips can be accessed when the connection clip covers are opened / removed.
- Before connecting the appliance, make sure the voltage indicated on the rating plate is consistent with the voltage in your home circuit.
- The rating plate with basic information is attached on the lower side of the hob.
- The appliance is manufactured for use with the power supply voltage 220-240 V ~.
- In order to make a fixed connection to the mains, insert an all-pole circuit breaker between the appliance and the mains. This device shall have a contact separation in all poles, providing full disconnection under overvoltage category III conditions.
- Given the protection from the risk of fire, appliances of this type may be installed in a worktop next to a piece of kitchen furniture that is taller than the appliance (when installed); however, in this case, a kitchen furniture element must be installed on the other side, adjacent to the appliance.
- The current conducting and isolated parts must be protected from any possibility of direct contact.

### WARNING!

- Before any intervention, disconnect the appliance from the power mains. Connect the appliance in compliance with the electric connections diagram supplied; make sure the relevant network voltage is observed! The ground wire (⊕) should be connected to the clip indicated by the earthing symbol.
- The mains cable should be fed through the fastening clip which protects it from being accidentally pulled out.
- After connecting the appliance, turn on all cooking zones / heaters for approximately three minutes to make sure they are operating correctly.

### Connecting

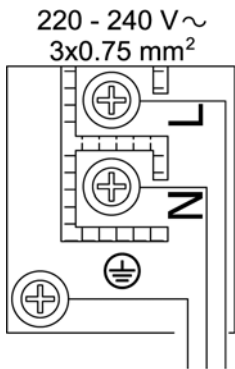

- Incorrect connection may destroy parts of the appliance, making the warranty void.
- Before connecting the appliance, make sure the voltage indicated on the rating plate is consistent with the voltage in your home network. Connection voltage should be checked by a qualified technician using a corresponding measuring device!
- Connection cable on the back of the appliance should be led in such way that it does not touch the appliance back wall, as this part will get very hot during operation.

#### The following can be used for connection:

- H05RR-F
- H07RN-F
- H05RN-F
- H05V2V2-F
- H05VV-F

LIVE	L	BROWN
EARTH	⊕	GREEN / YELLOW
NEUTRAL	N	BLUE

### CONNECTING TO THE GAS SUPPLY

- The appliance must be connected in compliance with all relevant regulations, and it may only be used in well ventilated / aerated rooms. Before connecting or using the appliance, please read the instruction manual.
- Before installing and connecting, make sure the local natural gas supply network and connection (type of gas and pressure), are compatible with your appliance version.

#### The category with the related types of gas can be used are included in Table "TECHNICAL INFORMATION".

- The version of this appliance is indicated on the rating plate.
  - This appliance is not suitable for connection to a burning fumes exhaust system (i.e. a chimney).
- The appliance must be installed and connected in compliance with the relevant effective installation regulations. Special care must be taken to ensure adequate ventilation / aeration (**a** = min. 100 cm<sup>2</sup>).

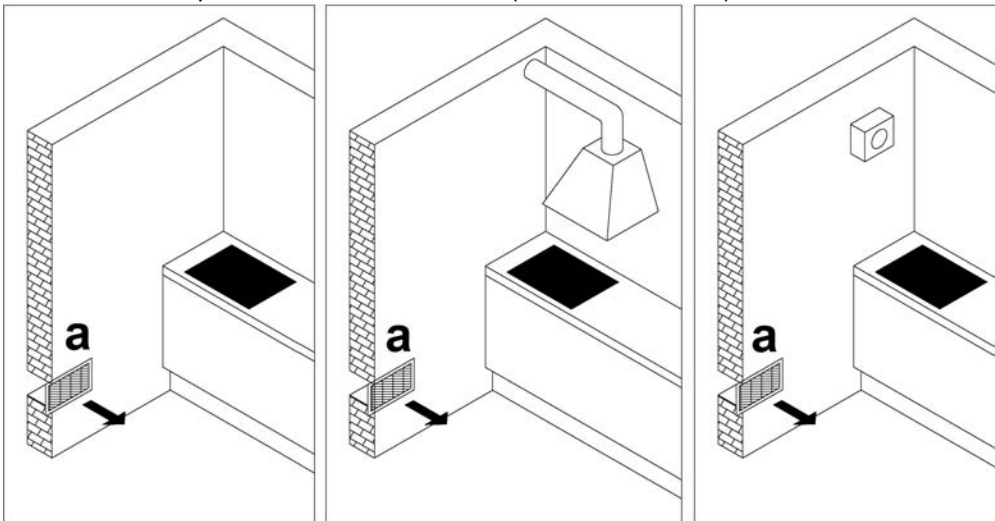

### Connection

- When connecting the appliance to the gas supply, follow the regulations of the local gas distributor.
- Also supplied with the appliance is an adapter for liquid gas, a taper male, and a non-metal gasket.
- On the lower side, the cooking hob is fitted with a gas connection plug with a ISO7-1 R1/2 thread.

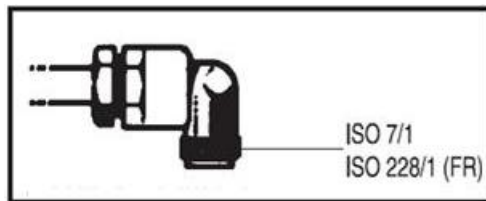

- When connecting, the knee R1/2 should be held firmly to prevent it from rotating.
- For sealing of the connection joints, use a non-metal approved gaskets and approved sealants.
- The gaskets should only be used once. The thickness of the flat non-metal gaskets should not be deformed more than by 25 percent.

This appliance is suitable for connection with rigid pipe or flexible hose. The isolating manual shut-off valve connection point must be accessible when the appliance is installed. Flexible hose assembly must be certified to AS/NZS 1869 class B or D, be of appropriate internal diameter for the total gas consumption, be kept as short as possible (not exceeding 1200mm), must not be in contact with the floor or any hot or sharp surfaces. The hose assembly must not be subject to strain, abrasion, kinking or deformation.

**After connecting the gas hob, check the joints for any leaks.**

Natural Gas: the supplied regulator must be fitted to the appliance inlet connection. Gas pressure must be adjusted to 1.0 kPa when approximately 50% of the burners are on high flame, the appliance test point is located on the regulator.

LPG: the supplied test point adaptor must be fitted to the appliance inlet connection. Gas pressure must be adjusted to 2.75 kPa, the appliance test point is located on the test point adaptor.

Gas leakage and operation of the appliance must be tested by the installer before leaving. Check burner flames are blue in colour, stable and completely ignite at both high and low flame settings with no appreciable yellow tipping, carbon deposition, lifting, floating, lighting back or objectionable odour. Test burners individually and in combination. When satisfied with the operation of the cooker, instruct the user on the correct method of operation. Not suitable for use with aftermarket lids or covers.

Where the data plate is obscured by cabinetry when the cooker is in the installed position, place the supplied duplicate data plate to a suitable adjacent surface or within this instruction manual for future reference.

**Only use pipes and seals in accordance with the Standards.** These pipes must be installed so that, when fully extended, their length does not exceed 2000 mm. For easier installation and to prevent gas leaks, attach the swivel coupling to the cook top first, and then to the gas mains pipe. Inverting this sequence may hamper the gas seal between the pipe and the cook top.

**Important: when the installation is complete, check that all couplings are completely sealed by using a soapy solution. Never use a flame. Also ensure that the flexible pipe cannot come into contact with any moving part of the cook top (e.g. drawer) and that it is not in a position where it could be damaged.**

After the connection, check the burners for correct operation.

The flames must be clearly visible, and should be blue and green at the center. If the flame is unstable, increase the minimum power.

### **Adaptation to a different type of gas**



- The procedure or adaptation of the cooker to another type of gas does not require removal of the appliance from the worktop.
- Before adapting, disconnect the appliance from the power mains and close the gas supply valve.
- Replace the existing nozzles for nominal thermal load with corresponding nozzles for the new gas type and supplied provided (see table below).
- After finishing this sequence, replace the old setting label with the new one provided for the new injectors.



## Adjustment elements

- To leave the adjustment elements accessible, please observe the following instructions:
- Remove the support grid and burner covers with respective crowns.
  - In double burners, adjustment elements are accessible behind the main nozzle protective plate.
  - Remove the control knobs, including the gaskets.

### **Gas valve**

Minimum thermal load regulation valve.

## Minimum flow adjustment

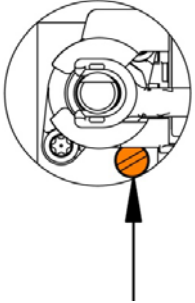

### **Instructions for town (G110, G120, G150.1) and methane gas (G20, G25)**

1. Light the burner and bring it to the minimum position.
2. Remove the gas tap knob and turn the adjustment screw on the side of the tap rod:
  - anti-clockwise to increase the gas flow
  - clockwise to reduce the gas flow
 until a regular minimum flame is obtained.
3. Re-assemble the knob and verify burner flame stability (when quickly rotating the hand from maximum to minimum position the flame must not shut off).
4. Repeat the operation on all gas taps.

### **Instructions for liquid gas (LPG: G30, G31)**

Tighten the screw on the side of the tap, rod clockwise completely.

**Warning: these tasks may only be carried out by a qualified technician, authorized by the gas distributing company or authorized service center!**

## TECHNICAL INFORMATION

497502 - 497503	
OPERATING VOLTAGE	220-240 V~ ; 50/60 Hz
CATEGORY GAS USAGE	Natural gas 1.0 kPa or Universal LPG 2.75
Qn <sub>GAS HOB</sub>	28,08 MJ/h

**A:** Auxiliary  
**SR:** Semirapid  
**MW:** Mini-Wok

## NOZZLE TABLE

Burner	A	SR	MW
Rated heat output (MJ/h)	3,60	6,30	11,88
Reduced Rate (MJ/h)	1,62	2,52	5,40
<b>Ø INJECTOR (mm)</b>			
Universal LPG	0,50	0,65	0,90
Natural gas	0,90	1,20	1,60
<b>Ø BY-PASS (mm)</b>			
Universal LPG	0,27	0,34	0,55
Natural gas	REG.	REG.	REG.

## Important warnings

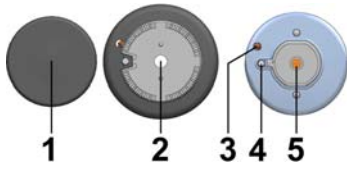

• The gas burners are fitted a candle as flame failure device. If the burner flame is extinguished accidentally or unintentionally, e.g. when some liquid boils over or when there is draught in the room, gas supply is automatically cut off, thus preventing the gas from being emitted into the room.

• Gas burner cover should always be placed on the burner crown very carefully. Make sure the slots on the burner crown are never obstructed.

- 1 Burner crown cover
- 2 Burner crown with the support for the burner cover
- 3 Candle flame failure device
- 4 Ignition candle
- 5 Nozzle

## Cookware

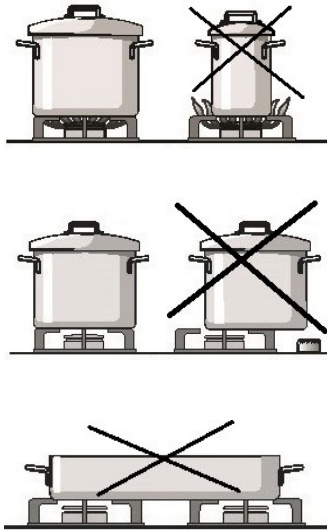

- Correctly selected cookware will enable optimum cooking time and gas consumption. Pan diameter is the most important parameter.
- Use pans which are the right size for each burner. Do not use small pans on large burners. The flame should not touch the sides of the pan.
- For combustion, the gas also needs air. If a pan is too large, air supply to the burner is insufficient; as a result, combustion effect is lesser.
- Always place the pan right over the burner, not to one side. Otherwise it could tip over. Do not place large pans on the burners near the control knobs. These may be damaged by the very high temperatures.
- Never use two burners or heat sources to heat one single pan. Do not use grill pans, earthenware casserole dishes, etc. for a long period of time on maximum power especially on cristall glass gas hobs.
- Pans should be placed on the hob carefully. Do not strike the hob and do not place excessive weight on it.
- Place the pans on the pan supports, never directly on the burner. Make sure that the pan supports and burner caps are correctly positioned before using the appliance.
- Stainless steel working table can burnish when subjected to excessive heat. Therefore we don't recommend prolonged cooking with soapstone, earthenware pans or cast iron plates. Avoid the use of aluminum foil to protect the working table during cooking operation.
  - Do not use cast iron plates or griddles for cooking or heating food on the burners (check the sizes of pot allowed for each kind of burner) specially on cristall glass gas hobs
- Cooktop should not be used as a worktop. Sharp objects can cause scratches.
- Preparing food in thin aluminum or plastic containers on hot cooking zones is not allowed. Do not place any plastic objects or aluminum foil on the cooktop.
- If sugar is spilt on a hot cooktop, or a sugar-laden food, immediately wipe the hob.
- To get the best from the burners, use flat-bottomed pots with a diameter suited to the burner being used.
- For smaller diameter pots and pans (coffee and tea pots, etc.), the power of the burner being used has to be regulated in order to ensure that the flame laps the bottom of the pot without spilling over.
- Do not use pots with concave or convex bottoms.

BURNER	MIN-MAX PAN Ø
A	12 - 18 cm
SR	18 - 22 cm
MW	22 - 26 cm

# INSTRUCTIONS FOR USE AND MAINTENANCE

## OPERATION

### Hob control elements

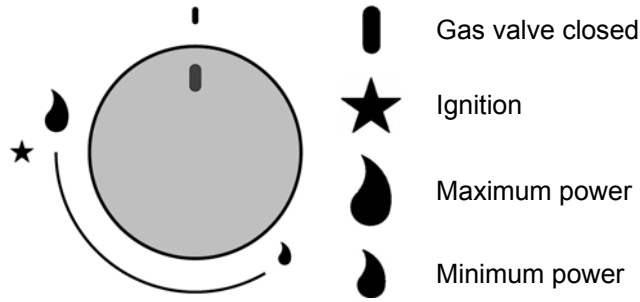

### Ignition and operation of the burners

#### **User's instructions**

This appliance must be used for the purpose it was designed for, i.e. domestic cooking. Any other use is considered to be improper and therefore dangerous. The manufacturer will accept no liability for any damage caused by improper, incorrect or irrational use.

#### **Using the burners**

- If the burners are not used for several days, wait a few seconds before lighting them in order to release any air from the pipes.
- As the cook top burners are fitted with an automatic ignition, to light them simply press and turn the handle to the small star. The appliance uses a spark ignition generator.
- If the flame does not ignite within five seconds, turn the knob back to the 0 position and repeat the procedure; if the electric ignition should not work due to a power failure or damp spark plugs, the gas can also be ignited using a match or a gas lighter.
- For models with a safety tap (which interrupt the gas flow should the flame accidentally go out) the burners are ignited as described above, but ensure **the knob is pressed in for 5 to 6 seconds after the flame has ignited**. After this time, which gives the safety device enough time to cut-in, the flame will be on permanently.
- The flame can then be set between the maximum and minimum level. Any setting between 0 and the large flame is not recommended, as the flame is not stable in this interval and may be extinguished.
- To extinguish the flame and close the burner gas supply, rotate the control knob to the 'Gas valve closed' position.

**WARNING:** once the cook top has been cleaned, ensure that the burners are firmly in their seats and do not interfere with the igniter.

**WARNING:** if the burner flame is extinguished accidentally, turn off the knob and leave it for at least one minute before trying to re-ignite it.

**CAUTION:** The gas cooking appliance use may cause heat, humidity and products of combustion in the room where is installed. Ensure that the kitchen is well ventilated especially when the appliance is in use: keep open any natural ventilation holes or install a mechanical ventilation device (mechanical extractor hood). Prolonged intensive use of the appliance may call for additional ventilation, for example opening of a window, or more effective ventilation, for example increasing the level of mechanical ventilation where present.

**CAUTION:** Accessible parts may be hot when the hob is in use. Young children should be kept away.

**CAUTION:** This appliance is for cooking purposes only. It must not be used for other purposes, for example room heating.

## **CLEANING AND MAINTENANCE**

**Do not use a steam cleaning appliance to clean this appliance. The steam could reach the electrical components and cause a short circuit.**

- The appliance should be cleaned regularly, preferably after each use, after cooling down.
- To avoid water marks and limescale deposits, use a soft cloth to dry surfaces that have been cleaned with water.
- Food that has boiled over can cause discolouration of the burner parts and the stainless steel cooktop. **Remove any soiling immediately.**

**To avoid damaging the outer surfaces of your appliance, do not use:**

- cleaning agents containing soda, alkalines, ammonia, acids or chlorides
- cleaning agents containing descaling agents
- stain or rust removers
- abrasive cleaning agents, e.g. powder cleaners and cream cleaners
- solvent-based cleaning agents
- dishwasher cleaner
- grill and oven cleaners
- glass cleaning agents
- hard, abrasive brushes or sponges, e.g. pot scourers, brushes or sponges which have been previously used with abrasive cleaning agents
- sharp pointed objects (these can damage the seal between the frame and the worktop).

### **Stainless steel surfaces**

Clean stainless steel surfaces using a microfibre cloth or with a solution of warm water and a little washing-up liquid applied with a soft sponge. In the case of stubborn dried-on soiling, soak first.

Finally, dry with a soft cloth.

The stainless steel cooktop cleaner can be used to clean the frame when required. Apply with an even pressure following the direction of the "grain".

The care product for stainless steel can be used after cleaning to help keep your appliance looking good and to hinder resoiling.

Apply sparingly with a soft cloth following the instructions on the packaging.

### **Printed surfaces**

The printing can be damaged if soiling (e.g. food or fluids that contained salt, olive oil) is not removed immediately.

Remove any soiling immediately.

Do not use any stainless steel cleaner on printed surfaces.

This would rub off the print.

### **Pan support and control knob**

**Do not clean the pan support in a dishwasher.**

Remove the pan support. Clean the pan support and the control knob with a solution of warm water and a little washing-up liquid applied with a soft sponge. Stubborn soiling should be soaked first.

After cleaning, dry all surfaces with a clean cloth.

### **Burners**

**Do not clean any parts of the burner in a dishwasher.**

The burner should be dismantled and then cleaned by hand using a solution of warm water and a little washing-up liquid applied with a soft sponge.

Parts of the burner that cannot be removed should be wiped clean with a damp cloth only.

The ignition candle and the candle flame failure device should be very carefully wiped clean using a well wrung out cloth.

Do not let the ignitor get wet. If it gets wet, it will not spark.

After cleaning, dry all surfaces with a clean cloth.

Make sure that the flame slits are clean and completely dry.

The surface of the burner crown cover will become more matt with time. This is quite normal and will not affect the operation of the cooktop.

**Annual service by an authorised person is recommended, or if any of the following conditions are noticed; incomplete ignition, appreciable yellow tipping, carbon deposition, lifting, floating, lighting back or objectionable odour.**

## Glass surface



Fig.1



Fig.2



Fig.3



Fig.4



Fig.5

After each use of the glass surface, wait for it to cool down and clean it; otherwise, even the smallest food residue will be burnt onto the hot surface next time you use the appliance.

For regular cleaning and maintenance of the glass surface, use special conditioning agents which form a protective layer on the surface, shielding it from dirt.

Before each use, wipe any dust or other particles from the hob surface and pan bottom as these could scratch the surface (Fig.1).

**Careful:** steel wool, abrasive sponges, and abrasive detergents can scratch the glass surface. Glass surface can also be damaged by aggressive sprays and inappropriate or insufficiently shaken (mixed) liquid cleaning agents (Fig.1 and Fig.2).

Signs and indications on the hob may be worn if aggressive cleaning aids are used on cooking zone edges, or if pans with damaged bottom or used.

Light stains can be removed by a damp soft cloth; then, wipe the surface dry (Fig.3).

Water stains can be removed using a mild solution of vinegar however, do not use this solution to clean the frame (only with some models, as it may become dull. Do not use aggressive sprays or decalcification agents (Fig.3).

Heavier stains can be removed using special agents and utensils for cleaning the glass surface. When using these products, follow the instructions provided by their respective manufacturers.

Make sure any residues of cleaning agents are thoroughly removed, as they could damage the glass surface when the cooking zones heat up (Fig.3).

Stubborn and burnt residues can be removed using a scraper. Make sure the plastic part of the scraper does not come into contact with a hot cooking zone. Be careful not to cut yourself with the scraper!

Sugar and sugar-laden food may permanently damage the glass surface (Fig.5); therefore, they should be removed from the glass surface as soon as possible, although the cooking zone may still be hot (Fig.4). Any change in the color of the glass surface does not affect its operation or its stability. Such discolorations are mostly a result of burnt food residues or use of cookware made of materials such as aluminum or copper; these stains are difficult to remove.

**Warning:** All damage described above predominantly relates to the aesthetics, i.e. appearance of the appliance and do not affect its functionality directly. Such errors cannot be the subject of a warranty claim.

## **PROBLEM SOLVING GUIDE**

### **Important**

- During the warranty period, only a service center authorized by the manufacturer may carry out any repairs.
- Before making any repairs, make sure the appliance is disconnected from the power mains either by removing the fuse or by disconnecting the power plug from the wall outlet.
- Unauthorized tampering with and repairs of the kitchen range (cooking hob) can result in electric shock or short circuit; hence, do not attempt to perform any repairs by yourselves. Leave such tasks to an expert or an authorized service unit.
- In case of minor faults or problems with the appliance operation, check the following instructions to see whether you can eliminate the causes by yourselves.

A visit by a service technician during the warranty period will be charged if the appliance is not functioning because of improper use. Store these instructions in a place where they are always readily accessible; if pass the appliance on to another person, the instructions should also be included.

Following is some advice on rectifying some common problems.

<b>Problem</b>	<b>Possible cause</b>	<b>Elimination</b>
The flame is uneven / unstable	Wrong gas power setting.	Have an expert check the gas pipeline!
The flame from the burners suddenly changes	Wrongly assembled parts of the kitchen hob	Assemble the burner correctly.
Burner ignition takes more time	Wrongly assembled parts of the kitchen hob	Assemble the burner correctly.
The flame is extinguished shortly after ignition	Knob pressed too short or too weakly.	Keep the knob depressed for a longer period of time. Before releasing it, press it harder.
The grid has discolored in the burner area	This is a commonplace phenomenon resulting from high temperature	Clean the grid with a metal care detergent.
Electric power supply in general is interrupted	The fuse may be blown	Check the fuse in the fuse box and replace it if it is blown
Electric ignition of the burners no longer works	There are food or detergent residues between the spark plug and the burner	Open and carefully clean the opening between the spark plug and the burner
If the burner cover looks unappealing	Regular dirt	Clean the burner covers with a metal care detergent.

If the problem persists despite observing the instructions above, call an authorized service technician. Elimination of any errors or warranty claims that resulted from improper connection or use of the appliance is not covered by our warranty. In such cases, the costs of repair are borne by the user.

**The Manufacturer strives for continuous improvements. For this reason, the text and illustrations in this book are subject to change without notice.**

Asko Appliances (Aust.) Pty.Ltd.  
(ABN 65 007 007 329) (Asko Australia).

Asko Australia contact details:  
Business address: 35 Sunmore Close, Moorabbin, Victoria 3189  
Telephone number: 1300 00 2756  
Email address: care.australia@gorenje.com



[www.gorenje.com](http://www.gorenje.com)



---

LIB30692  
R02-010616