

ASKO

Inspired by Scandinavia

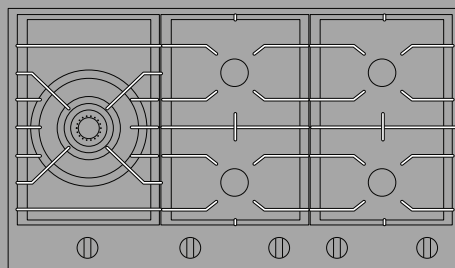

INSTRUCTIONS FOR USE

Gas hob

EN

HG1666AB - HG6CBE1C

HG1666SB - HG6CBE1C

HG1776AB - HG7BBE1C

HG1776SB - HG7BBE1C

HG1986AB - HG9CBE1C

HG1986SB - HG9CBE1C

Contents

Pictograms used	3	Faults	12
Safety	4	Troubleshooting table	12
Safe use	6	Technical data	13
Description	7	Information according to regulation (EU)	
Use	8	66/2014	13
Pans	8	Installation	15
Wok ring	8	Safety regulations	15
Pan support	8	Preparations for installation	16
Burner	9	Built-in	17
Operation	10	Gas connection	18
Ignition and adjustment	10	Connecting & testing	19
Maintenance	11	Environmental aspects	20
Daily cleaning	11	Disposal of the appliance and packaging	20

The following symbols are used throughout the manual, and they have the following meanings:

 INFORMATION!

Information, advice, tip, or recommendation

 WARNING!

Warning – general danger

 GAS CONNECTION!

Warning – gas connection

 ELECTRIC SHOCK!

Warning – danger of electric shock

 HOT SURFACE!

Warning – danger of hot surface

 DANGER OF FIRE!

Warning – danger of fire

It is important that you carefully read the instructions.

WARNING!

READ CAREFULLY AND KEEP IT FOR FUTURE REFERENCE!

This appliance can be used by children aged 8 years and over, as well as by people with reduced physical, sensory or mental capabilities or lack of experience and knowledge, provided they are supervised and instructed in the safe use of the appliance and understand the hazards involved.

- This appliance and the accessible parts will become hot during use. Do not touch hot parts. Keep children younger than 8 away from the appliance unless they are under continuous supervision.
- Use only hob guards designed by the manufacturer of the cooking appliance or indicated by the appliance manufacturer in the instructions for use as suitable or hob guards incorporated in the appliance. The use of inappropriate guards can cause accidents.
- Prolonged intensive use of the appliance may call for additional ventilation, for example opening of a window, or more effective ventilation, for example increasing the level of mechanical ventilation where present.

General

The manufacturer cannot be held liable for any damage resulting from failure to follow the safety instructions and warnings.

Damage caused by incorrect connection, incorrect fitting, or incorrect use is not covered by the warranty.

DANGER OF FIRE!

WARNING: Danger of fire: do not store items on the cooking surfaces.

WARNING: Cooking with fat or oil on a hob without supervision can be dangerous and can lead to a fire.

CAUTION! The cooking process has to be supervised. A short term cooking process has to be supervised continuously.

Do not allow children to play with the appliance.

Do not allow children to clean or maintain the appliance unless supervised.

NEVER try to extinguish a fire with water. Instead, switch the appliance off and then cover the flames with, for example, a lid or a fire blanket.

If a drawer underneath the appliance is permitted (see the installation instructions), without an intermediate bottom, this should not be used to store highly flammable objects/materials. Ensure that there is adequate clearance of a few centimetres between the bottom of the hob and the contents of any drawers.

The hob is only to be used for the preparation of food.

The appliance is not designed for heating rooms.

The appliance is not intended to be operated by means of an external timer or separate remote control system.

Never open the casing of the appliance.

Never use a steam cleaner for cleaning the appliance. Only clean the appliance when switched off. The steam of a steam cleaner could reach the conducting parts and cause an electrical short.

CAUTION: The use of a gas cooking appliance results in the production of heat, moisture and products of combustion in the room in which it is installed. Ensure that the kitchen is well ventilated especially when the appliance is in use: keep natural ventilation holes open or install a mechanical ventilation device (mechanical extractor hood).

The burner components are hot during and immediately after use. Do not touch them, and avoid contact with non-heat resistant materials.

The distance between the pan and a knob or non-heat resistant wall should always be greater than one centimetre. In the case of smaller distances, the high temperature may cause the knobs or wall to discolour and/or deform.

Ceramic glass plate broke

- Shut immediately off all burners and any electrical heating element and isolate the appliance from the power supply.
- Do not touch the appliance surface.
- Do not use the appliance.

Safe use

- Do not keep objects that children might find interesting in cupboards above or behind the appliance.
- The cooking zones/burners heat up during use and stay hot for a while afterwards. Keep young children away from the hob during and immediately after cooking.
- Never flambé under a cooker hood. The high flames can cause a fire, even if the cooker hood is switched off.
- Do not warm closed tins on the hob. There will be a build-up of pressure that will cause tins to explode. You might get injured or scalded.
- Never cover the appliance with a cloth or something similar. If the appliance is still hot or is switched on, there is a risk of fire.
- Do not use the appliance as a worktop. The appliance may accidentally be switched on or still be hot, which means objects could melt, become hot or catch fire.
- Do not use the appliance in temperatures below 5 °C.
- The appliance should not be placed or used outdoors.
- When you use the hob for the first time, you will notice a "new smell". Don't worry, this is normal. If the kitchen is well ventilated, the smell will soon disappear.
- The ceramic top is extremely strong but not unbreakable. For example, a spice jar or sharp utensil falling on it could cause it to break.
- Never immerse hot burner caps and pan supports in cold water. Rapid cooling can damage the enamel.
- Always use the pan supports and suitable cookware.
- Always place the pan on the pan support. Placing the pan directly on the burner cap can result in dangerous situations.
- Aluminium trays or foil are not suitable as cooking utensils. They can burn into the burner caps and pan supports.
- The hob can only function effectively if the burner components have been assembled using the guide ridges. Ensure that the pan supports lie properly against each other and flat on the drip tray. Only then can the pans be positioned stably.
- Keep oven gloves or oven cloths away from the flame.
- Do not use griddle plates or baking plates.
- Clean the burner parts regularly for the safe and correct operation of the burners.
- Missing rubber feet from the pan supports can cause scratches on the drip tray or poor combustion of the burner. If the rubber feet are missing, please contact our service department.

1. Semi-rapid burner
2. Simmer burner
3. Rapid burner
4. Wok burner
5. Pan support
6. Drip tray
7. Control knob

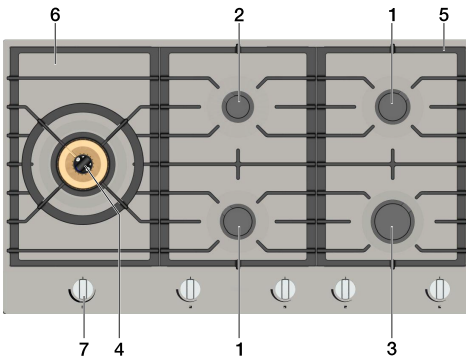
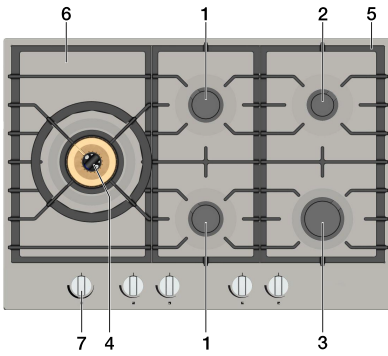
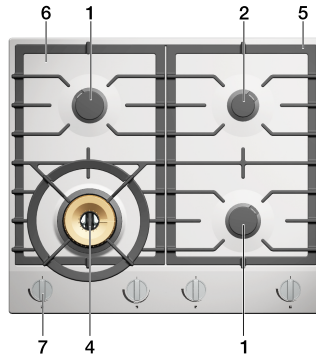

Use

Pans

Always ensure that the flames remain under the pan. A lot of energy is lost when flames burn around the outside of the pan. The handles could also become too hot.



wrong

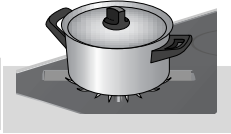

right

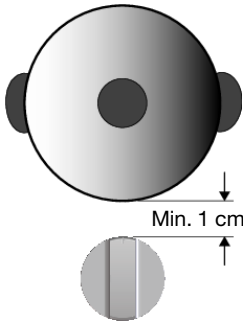

WARNING!

The distance between the pan and a knob or non-heat resistant wall should always be greater than one centimetre. In the case of smaller distances, the high temperature may cause the knobs or wall to discolour and/or deform.

Wok ring

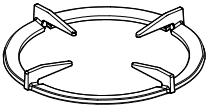

The wok ring for use with the wok burner supplied or obtainable as an accessory provides extra stability for woks with a round base.

Pan support

Place the pan support vertically, without sliding it over the glass top. Use the positioning notches to position the pan support on the glass top.

Burner

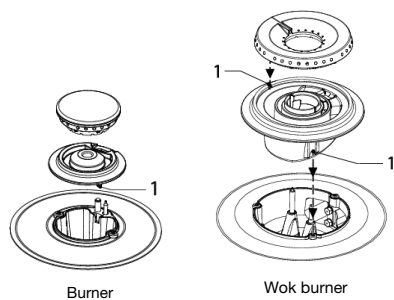

Use the leads (1) to put together the burner parts.

Place the wok burner in the correct way. Placing the wok burner parts incorrectly can result in a poorly functioning burner.

Operation

Ignition and adjustment

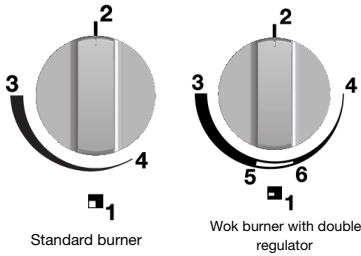

1. Zone indication
2. 0 position
3. High setting
4. Inner ring low setting
5. Outer ring low setting / inner ring high setting
6. Outer ring off / inner ring high setting

The burner is fully adjustable between high and low settings.

1. Press the control knob and turn it anticlockwise. The burner will ignite.
 2. Keep the control knob fully depressed for at least 3 seconds between high and low settings. The thermocouple safety pilot has been activated.
- The wok burner with a double regulator is easy to control.
 - The outer ring can be adjusted between high setting and low setting between positions 3 and 5. The inner ring will then continue to burn on high setting.

Daily cleaning

Regular maintenance after use prevents spilt food from setting too long and creating stubborn stains. Use a mild detergent for this.

First clean the control knobs, burners and pan support and only then the drip tray or glass cover. This prevents the drip tray or glass cover to becoming dirty again after cleaning.

NOTE!

- Burner parts should not be cleaned in the dishwasher.
- Dishwasher detergents can corrode burner parts!

Stubborn stains

Persistent stains can best be removed with a fluid detergent or a plastic scouring sponge. Never use scouring powder, scouring pads, sharp objects or aggressive cleaning products.

Persistent stains on the glass cover

Clean the glass cover with a special cleaning product for ceramic hobs. Water stains or limescale are best cleaned using cleaning vinegar.

NOTE!

- Never use abrasives. These leave scratches in which dirt and limescale can accumulate.
- Never use anything sharp such as steel wool or scourers.

Persistent stains on the stainless steel (drip trays)

Persistent stains on stainless steel are best removed with a special stainless steel cleaning product. Always wipe with the structure of the steel to prevent scraping away the protective layer (damage caused in this way does not fall under the guarantee!) The surface of stainless steel drip trays can discolour slightly over time.

Brass wok burner parts

Some wok burner parts are made of brass. It is not unusual to see a change in the colour of the brass as a result of the high temperatures involved in wok use.

TIP!

Consult the website for additional maintenance and cleaning instructions!

Faults

Troubleshooting table

If your hob does not work properly, it does not always mean that it is defective. Make sure to check the points mentioned below in the table, or visit our website for more information.

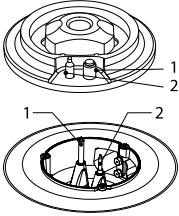
Symptom	Possible cause	Solution
There is a smell of gas near the appliance.	The appliance connection is leaking.	Turn off the main gas supply valve. Contact your installer.
The burner does not ignite. 	The electrical connection is not correct.	Contact your installer.
	Fuse defective/fuse switched off in fuse cupboard.	Replace the fuse or switch on the fuse again in the fuse box.
	Spark plug (1) dirty/damp.	Clean/dry the spark plug.
	Burner parts not placed correctly.	Use the centring notches to put the burner parts together.
	Burner parts dirty/damp.	Clean/dry the burner parts. Make sure that the outflow holes are open.
	Main gas supply valve closed.	Open the main gas valve.
	Fault in gas mains.	Consult you gas supplier.
	Gas bottle or tank is empty.	Connect a new gas bottle or have the tank refilled.
	The wrong type of gas used.	Check whether the gas used is suitable for the appliance. Contact your installer if it is not correct.
The burner does not burn evenly.	Burner parts not placed correctly.	Use the centring notches to put the burner parts together.
	Burner parts dirty/damp.	Clean/dry the burner parts. Make sure that the outflow holes are open.
	The wrong type of gas used.	Check whether the gas used is suitable for the appliance. Contact your installer if it is not correct.
Burner extinguishes after igniting.	The control knob has not been depressed long or deep enough (at least 3 seconds).	Keep the control knob fully depressed for at least 3 seconds between high and low settings. This can take longer the first time because of the gas supply.
	Thermocouple (2) is dirty.	Clean/dry the thermocouple.

Information according to regulation (EU) 66/2014 Measurements according EN60350-2 / EN 30-2-1

Model identification		HG1666A / HG1666S
Type of hob		Gas hob
Number of gas burners		4
Energy efficiency per gas burner (EE _{gas burner}) in %	Rapid burner	-
	Semi-rapid burner	60.2
	Wok burner	55.1
Energy efficiency for the gas hob (EE _{gas hob}) in %		58.5

Model identification		HG1766A / HG1766S
Type of hob		Gas hob
Number of gas burners		5
Energy efficiency per gas burner (EE _{gas burner}) in %	Rapid burner	57.5
	Semi-rapid burner	60.2
	Wok burner	55.1
Energy efficiency for the gas hob (EE _{gas hob}) in %		58.3

Model identification		HG1986A / HG1986S
Type of hob		Gas hob
Number of gas burners		5
Energy efficiency per gas burner (EE _{gas burner}) in %	Rapid burner	57.5
	Semi-rapid burner	60.2
	Wok burner	55.1
Energy efficiency for the gas hob (EE _{gas hob}) in %		58.3

Technical data

Gas table	G25.3 25 mbar G25 25 mbar	G20 20 mbar	G30 / G31 28-30 / 37 mbar
	kW	kW	kW / g/h
Simmer burner	1.00	1.00	0.80 / 58
Semi-rapid burner	2.00	2.00	1.50 / 108
Rapid burner	3.00	2.60	2.00 / 144
Wok burner	4.60	4.60	4.00 / 288
Wok burner HG1666	4.20	4.20	4.00 / 288

Safety regulations

- If the supply cord is damaged, it must be replaced by the manufacturer, its service agent or similarly qualified persons in order to avoid a hazard.
- This appliance should only be connected by a registered installer.
- Prior to installation, ensure that the local distribution conditions (voltage, frequency, nature of the gas and gas pressure) and the adjustment of the appliance are compatible.
- The voltage, frequency, power, type of gas and the country for which the appliance has been designed are shown on the appliance rating plate.
- The walls and the worktop surrounding the appliance must be heat resistant up to at least 105 °C.
- The worktop into which the hob is fitted should be flat.

Electrical connection

- This appliance must be earthed.
- The electrical connection must comply with national and local regulations.
- The wall plug socket and plug should always be accessible.
- If a stationary appliance is not fitted with a supply cord and a plug, or with other means for disconnection from the supply mains having a contact separation in all poles that provide full disconnection under overvoltage category III conditions, the means for disconnection must be incorporated in the fixed wiring in accordance with the wiring rules. Using an omnipolar switch with a contact separation of at least 3 mm fitted in the supply cable will fulfil this requirement.
- The supply cord must hang freely and should not be fed through a drawer.

Gas connection

- Gas connection 1/2" ISO 228 / ISO 7-1 / EN 10226-1 (1/2" ISO 228 / 1/2" ISO 228 FR only).
- The gas connection must comply with national and local regulations. See appliance label for technical gas data.
- This appliance is not connected to a combustion products evacuation device. It shall be installed and connected in accordance with current installation regulations. Particular attention shall be given to the relevant requirements regarding ventilation.
- We recommend that the gas hob be connected by means of a fixed pipe. Connection using a specially designed safety hose is also permitted.
- The pipe behind the oven must be made entirely out of metal.
- A safety hose may not be bent and must not come into contact with moving parts of kitchen units.
- The gas supply valve must always be placed in an easily accessible position.

Installation

Preparations for installation

Free space around the appliance

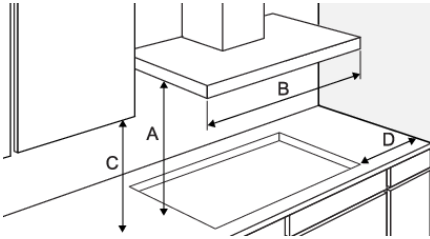

	A (mm)	B (mm)	C (mm)	D (mm)
HG16	≥650	≥600	≥450	≥120
HG17	≥650	≥750	≥450	≥120
HG19	≥650	≥900	≥450	≥120

Accessibility

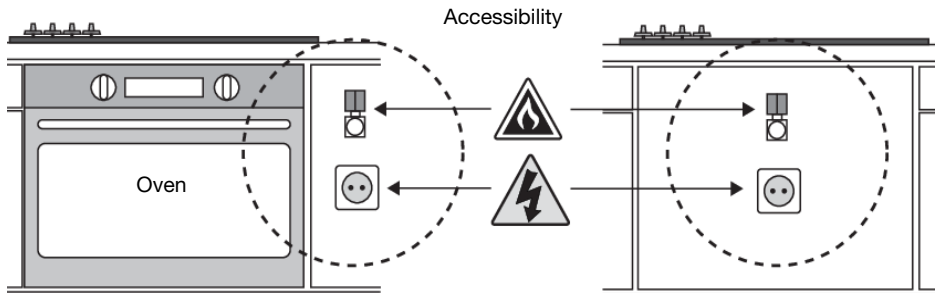

Ventilation

CAUTION!

Prevent ventilation interference if an oven is installed underneath the gas hob.

Make sure there is sufficient air supply (option 1) **or** separate air ventilation between the oven and hob by applying an air shield 'P' (option 2).

Also consult the installation instruction of the oven.

Option 1

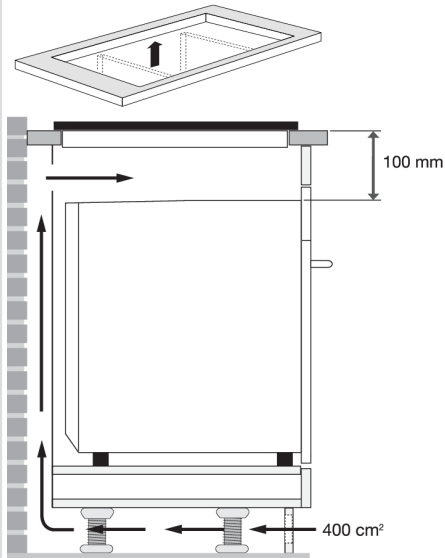

Option 2

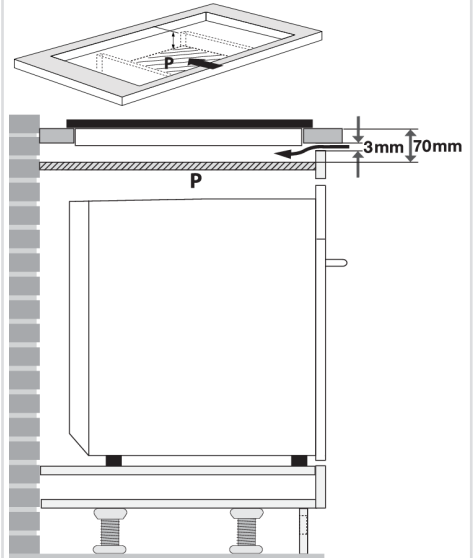

Built-in

Appliance dimensions

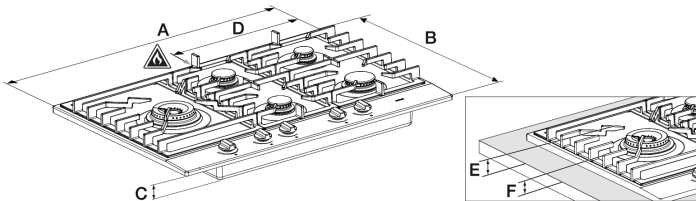

	A (mm)	B (mm)	C (mm)	D (mm)	E (mm)	F (mm)
HG16	600	526	48	520	61	43
HG17	750	526	48	594	65	47
HG19	900	526	48	514	61	43

Installation

Cut-out in the worktop

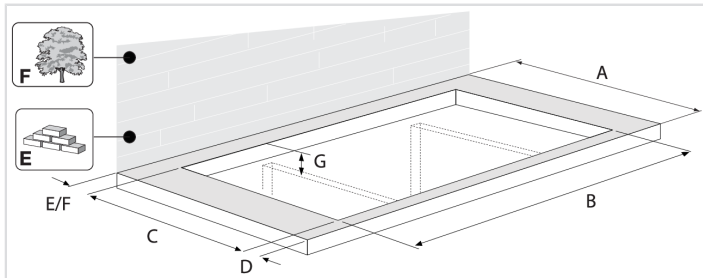

	A (mm)	B (mm)	C (mm)	D (mm)	E (mm)	F (mm)	G (mm)
HG16/HG17	600	560	490	60	>30	> 50	55
HG19	600	860	490	60	>30	>50	55

Sealing tape

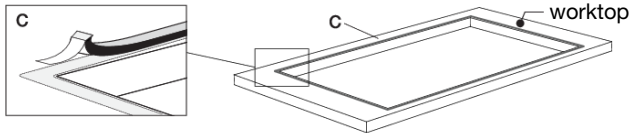

Install the appliance in the worktop

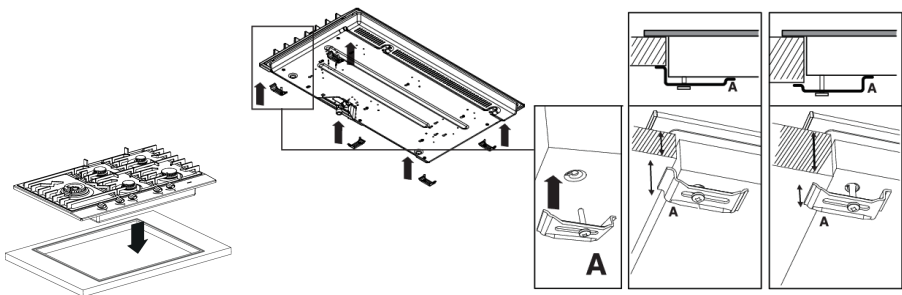

Gas connection

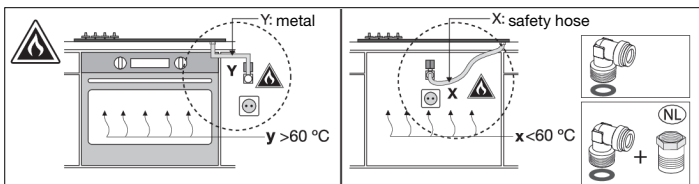

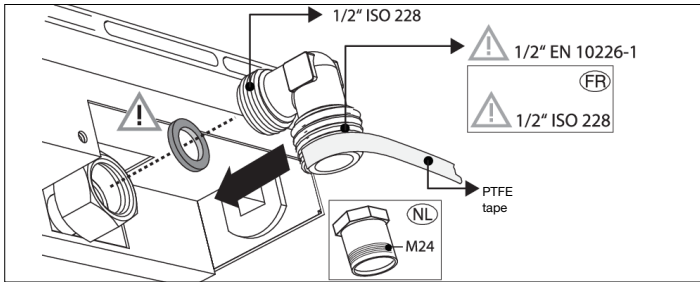

Connecting & testing

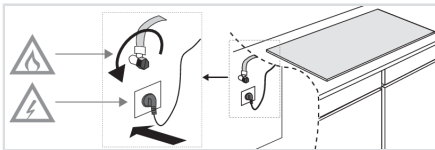

⚠ WARNING!

Check if connections are gas-tight.

Environmental aspects

Disposal of the appliance and packaging

Sustainable materials have been used during the manufacture of this appliance. This appliance must be disposed of responsibly at the end of its service life. Ask your local authorities for more information about how to do this.

The appliance packaging is recyclable. The following may have been used:

- cardboard;
- polyethylene film (PE);
- CFC-free polystyrene (PS rigid foam).

Dispose of these materials in a responsible manner and in accordance with government regulations.

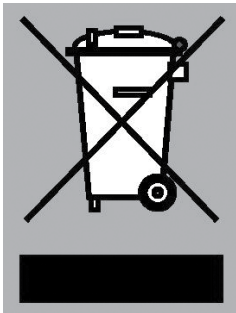

The product has been marked with a crossed-out dustbin symbol to remind you of the obligation to dispose of electrical household appliances separately. This means that the appliance may not be included with normal domestic refuse at the end of its service life. The appliance must be taken to a special municipal centre for separated waste collection or to a dealer providing this service.

A separate collection of household appliances helps to prevent any potential negative impact on the environment and on human health caused by improper disposal. It ensures that the materials of which the appliance is composed can be recovered to obtain significant savings in energy and raw materials.

NOTE!

Please note! Do not throw a broken ceramic glass plate in the glass recycling bin but take this to the Municipality's waste recycling centre.



Declaration of conformity

We hereby declare that our products satisfy the applicable European directives, orders and regulations, as well as the requirements stated in the referenced standards.

The appliance identification card is located on the bottom of the appliance.

Stick the appliance identification card here.

 **ASKO**

Inspired by Scandinavia

www.asko.com



856550-a13

CE

We reserve the right to make changes.