

---

## DEAR CUSTOMER

We sincerely thank you for your purchase. We believe you will soon find ample evidence that you can really rely on our products. To make the use of the appliance easier, we attach these comprehensive instruction manual.

The instructions should aid you in getting familiar with your new appliance. Please, read them carefully before using the appliance for the first time.

In any case, please make sure the appliance was supplied to you undamaged. Should you identify and transport damage, contact your sales representative or the regional warehouse from where the product was delivered. You will find the telephone number on the receipt or delivery report.

We wish you a lot of pleasure with your new household appliance.



The appliance for household use for heating food and beverages using electromagnetic energy, for indoor use only.

---

## INSTRUCTIONS FOR USE

These instructions are intended for the user. They describe the cooker and how to use it. They also apply to different types of appliances, therefore you may find some descriptions of functions that may not apply to your appliance.

## IMPORTANT SAFETY INSTRUCTIONS



Never touch the surfaces of heating or cooking appliances. They will become hot during operation. Keep children at a safe distance. There is a risk of burning!



Microwave energy & High voltage!  
Do not remove the cover.

**WARNING!** The appliance and its accessible parts become hot during use. Care should be taken to avoid touching heating elements. Children less than 8 years of age shall be kept away unless continuously supervised. Children should be supervised to ensure that they do not play with the appliance.

This appliance can be used by children aged from 8 years and above and persons with reduced physical, sensory or mental capabilities or lack of experience and knowledge if they have been given supervision or instruction concerning use of the appliance in a safe way and understand the hazards involved. Children shall not play with the appliance. Cleaning and maintenance shall not be made by children unless they are older than 8 and supervised.

Keep the appliance and its cord out of reach of children less than 8 years.

- **WARNING:** When the appliance is operated in the combination mode, children should only use the oven under adult supervision due to the temperatures generated; (Only for the model with grill function)

- **WARNING:** If the door or door seals are damaged, the oven must not be operated until it has been repaired by a competent person;
- **WARNING:** It is hazardous for anyone other than a competent person to carry out any service or repair operation that involves the removal of a cover which gives protection against exposure to microwave energy;
- **WARNING:** liquids and other foods must not be heated in sealed containers since they are liable to explode.
- Children should be supervised to ensure that they do not play with the appliance.
- Don't remove oven's feet, do not block air vents of the oven.
- Only use utensils that are suitable for use in microwave ovens.
- When heating food in plastic or paper containers, keep an eye on the oven due to the possibility of ignition;
- If smoke is observed, switch off or unplug the appliance and keep the door closed in order to stifle any flames;
- Microwave heating of beverages can result in delayed eruptive boiling, therefore care must be taken when handling the container;
- The contents of feeding bottles and baby food jars shall be stirred or shaken and the temperature checked before consumption, in order to avoid burns;
- Eggs in their shell and whole hard-boiled eggs should not be heated in microwave ovens since they may explode, even after microwave heating has ended;

- When cleaning surfaces of door, door seal, cavity of the oven, use only mild, nonabrasive soaps, or detergents applied with a sponge or soft cloth.
- The oven should be cleaned regularly and any food deposits removed;
- Failure to maintain the oven in a clean condition could lead to deterioration of the surface that could adversely affect the life of the appliance and possibly result in a hazardous situation;
- If the supply cord is damaged, it must be replaced by the manufacturer, its service agent or similarly qualified persons in order to avoid a hazard.
- Do not let the cord hang over the edge of the table or worktop.
- Never connect this appliance to an external timer switch or remote control system in order to avoid a hazardous situation.
- Never replace the light bulb inside the oven. It must always be replaced by Gorenje service.
- Do not clean the appliance with steam cleaners, high-pressure cleaners, sharp objects, abrasive cleaning agents, and abrasive sponges and stain removers.

## SAFETY INSTRUCTIONS FOR GENERAL USE

Listed below are, as with all appliances, certain rules to follow and safeguards to assure top performance from this oven:

1. Always have the glass tray, roller arms, coupling and roller track in place when operating the oven.
2. Do not use the oven for any reason other than food preparation, such as for drying clothes, paper, or any other nonfood items, or for sterilizing purposes.
3. Do not operate the oven when empty. This could damage the oven.
4. Do not use the oven cavity for any type of storage, such as papers, cookbooks, etc.
5. Do not cook any food surrounded by a membrane, such as egg yolks, potatoes, chicken livers, etc without first being pierced several times with a fork.
6. Do not insert any object into the openings on the outer case.
7. Do not at any time remove parts from the oven such as the feet, coupling, screws, etc.
8. Do not cook food directly on the glass tray. Place food in/on proper cooking utensil before placing in the oven.

### **IMPORTANT - COOKWARE NOT TO USE IN YOUR MICROWAVE OVEN**

- Do not use metal pans or dishes with metal handles.
  - Do not use anything with metal trim.
  - Do not use paper covered wire twist-ties on plastic bags.
  - Do not use melamine dishes as they contain a material which will absorb microwave energy. This may cause the dishes to crack or char and will slow down the cooking speed.
  - Do not use Centura Tableware. The glaze is not suitable for microwave use. Corelle Livingware closed handle cups should not be used.
  - Do not cook in a container with a restricted opening, such as a pop bottle or sealed oil bottle, as they may explode if heated in a microwave oven.
  - Do not use conventional meat or candy thermometers.
  - There are the thermometers available specifically for microwave cooking. These may be used.
9. Microwave utensils should be used only in accordance with manufacturer's instructions.
  10. Do not attempt to deep-fry foods in this oven.
  11. Please remember that a microwave oven only heats the liquid in a container rather than the container itself. Therefore, even though the lid of a container is not

hot to the touch when removed from the oven, please remember that the food/liquid inside will be releasing the same amount of steam and/or spitting when the lid is removed as in conventional cooking.

12. Always test the temperature of cooked food yourself especially if you are heating or cooking food/liquid for babies. It is advisable never to consume food/liquid straight from the oven but allow it to stand for a few minutes and stir food/liquid to distribute heat evenly.
13. Food containing a mixture of fat and water, e.g. stock, should stand for 30-60 seconds in the oven after it has been turned off. This is to allow the mixture to settle and to prevent bubbling when a spoon is placed in the food/liquid or a stock cube is added.
14. When preparing/cooking food/liquid and remember that there are certain foods, e.g. Christmas puddings, jam and mincemeat, which heat up very quickly. When heating or cooking foods with a high fat or sugar content do not use plastic containers.
15. Cooking utensil may become hot because of heat transferred from the heated food. This is especially true if plastic wrap has been covering the top and handles of the utensil. Potholders may be needed to handle the utensil.
16. To reduce the risk of fire in the oven cavity:
  - a) Do not overcook food. Carefully attend microwave oven if paper, plastic, or other combustible materials are placed inside the oven to facilitate cooking.
  - b) Remove wire twist-ties from bags before placing bag in oven.
  - c) If materials inside the oven should ignite, keep oven door closed, turn the oven off at the wall switch, or shut off power at the fuse or circuit breaker panel.



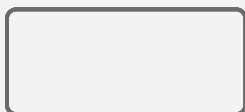
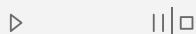





# CONTROL PANEL









## DISPLAY UNIT

Displays the selected functions and time.



## DISPLAY UNIT ICONS

-  Microwaves
-  Grill
-  Combined (microwaves + grill)
-  \*h Rapid defrost, by time
-  \*g Auto defrost, by weight
-  Automatic programmes
-  Minute minder (alarm)
-  Clock (time of day)
-  Child lock

## KEYS

-  Microwaves
-  Grill
-  Combined (microwaves + grill)
-  Defrosting
-  Auto menu
-  Minute minder/Clock

## ROTARY KNOB

-  Start
-  Pause/Stop

## DOOR OPENING KNOB

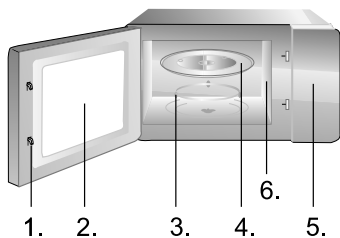

1. Door Safety Lock System
2. Oven Window
3. Roller Ring
4. Glass Tray
5. Control Panel
6. Wave guide (please do not remove the mica plate covering the wave guide)

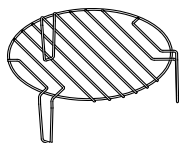

Grill rack (Only be used for grill or for combination function and be placed on glass tray)

# INSTRUCTIONS FOR USE

## 1. CLOCK

**The oven is fitted with a digital clock. When the oven is in the standby mode, the clock can be set in the 24-hour mode by pressing the CLOCK key.**

Example: To set the time to 8:30:

1. When the oven is in the standby mode, press and hold the CLOCK key for three seconds. The time display will start to flash. Set the hours to 08:00 by rotating the knob and pressing it when the desired number for hours is set.
2. Then, rotate the knob to set the minutes so that the display reads 08:30; then, press the knob to confirm.

**NOTE:** During cooking, clock can be displayed at any time by pressing the CLOCK key. Clock has to be set every time the oven is connected or re-connected to the power mains.

## 2. COOKING AND REHEATING WITH MICROWAVES

**This function has two options:**

**a) Rapid heating with microwaves (100% power)**

Example: Cooking with 100% power for 5 minutes.

1. Use the rotary knob to set the time to 05:00.
2. Press the START key to start the program.

**b) Heating with microwaves with manual control**

Example: Heating the food with a power of 600 W for 10 minutes.

1. Press the MICROWAVES key.
2. Press the MICROWAVE key several times or use the rotary knob to set the power level to 600 W. Confirm the setting by pressing on the knob.
3. Use the rotary knob to set the time to 10:00.
4. Press the START key to start the program.

There are 7 power levels available (in W): 700, 600, 500, 400, 300, 200, and 100; maximum operating time is 95 minutes.

## 3. GRILL

**Grilling is especially suitable for thin slices of meat, escalopes or steaks, meat chops, skewers, sausages, or pieces of chicken. Grilling is also suitable for toasting bread or sandwiches and finishing dishes au gratin. Maximum operating time that can be set for the grill is 95 minutes.**

Example: Grilling for 12 minutes

1. Press the GRILL key.
2. Rotate the knob to set the time to 12:00.



3. Press the START key to start the program.

**NOTE:** During cooking or grilling, the oven will automatically beep twice when halfway through the progress. This is to remind you to turn around the food. After this is done, close the oven door and press the START key. If you do not wish to turn around the food, cooking or grilling will continue.

---

#### 4. COMBINED OPERATION

**The oven will operate with microwaves 55 percent of the time, and with grill 45 percent of the time. This operating mode is suitable for cooking fish or dishes au gratin. Maximum operating time that can be set is 95 minutes.**

Example: Set combined operation C-1 for 25 minutes.

1. Press the COMBINED mode key. »C-1« will appear on the screen.
2. Confirm the selected combination by pressing the knob.
3. Rotate the knob to set the time to 25:00.
4. Press the START key to start the program.

---

#### 5. COMBINED OPERATION C-2

**The oven will operate with microwaves 36 percent of the time, and with grill 64 percent of the time. This operating mode is suitable for cooking pudding, soufflés, omelettes, baked potatoes, and poultry. Maximum operating time that can be set is 95 minutes.**

Example: Set combined operation C-2 for 25 minutes.

1. Press the COMBINED mode key twice, or set the desired mode by rotating the knob. »C-2« will appear on the screen. Confirm by pressing the KNOB.
2. Use the knob to set the time to 25:00.
3. Press the START key to start the program.

---

#### 6. AUTO DEFROST

**The oven allows defrosting of meat, poultry, and seafood. Defrosting time and operating power will be adjusted automatically according to the preset weight. Weight of the food to be defrosted may be between 100 g and 2000 g.**

Example: Defrosting 600 g of frozen fish

1. Press the DEFROST key.
2. Rotate the knob to set the weight to 600 g.
3. Press the START key to start the program.

**NOTE:** During defrosting, the oven will automatically beep twice when halfway through the progress. This is to remind you to turn around the food. After this is done, close the

oven door and press the START key. If you do not wish to turn around the food, cooking or roasting will continue.

## 7. SPEED DEFROST

**The oven also allows speed defrosting.**

Example: Rapid defrosting of bread

1. Press the DEFROST key twice or select the symbol on the display unit which displays defrosting by time.
2. Rotate the knob to set the desired time.
3. Press the START key to start the program.

**NOTE:** During defrosting, the oven will automatically beep twice when halfway through the progress. This is to remind you to turn around the food. After this is done, close the oven door and press the START key. If you do not wish to turn around the food, cooking or grilling will continue.

## 8. AUTO MENU

**For the food in the auto menu, only the type of food and the weight/amount have to be set. The oven will aid you in the setting of power and time.**

Example:

1. Press the AUTO MENU key.
2. Press the AUTO MENU key several times or rotate the knob to select the desired type of food. Choose between programs from A-1 to A-8. Confirm the setting by pressing on the knob.
3. Rotate the knob to select the approximate weight/amount.
4. Press the START key to start the program.

Menu	Weight/amount	Microwave power
A-1 Rapid reheating	150g	100%
	250g	
	350g	
	450g	
	600g	
A-2 Liquid	1 cup	100%
A-3 Popcorn	50g	100%
	100g	
A-4 Meat	150g	100%
	300g	
	450g	
	600g	

Menu	Weight/amount	Microwave power
A-5 Potatoes	230g	100%
	460g	
	690g	
A-6 Vegetables	150g	100%
	350g	
	500g	
A-7 Fish	150g	80%
	250g	
	350g	
	450g	
	650g	
A-8 Pasta	50 g (450 ml water)	80%
	100 g (800 ml water)	
	150 g (1200 ml water)	

## 9. MULTI-STAGE COOKING

### Microwave oven allows cooking in two steps.

Example: To defrost frozen meat for 10 minutes, then heat it for 5 minutes at 600 W:

1. Press the DEFROST key twice.
2. Use the knob to set the time to 10:00 and confirm.
3. Press the MICROWAVES key.
4. Use the knob to set the power to 600 W.
5. Press the START key to start the program.

**NOTE:** Defrost function can only be used in the first step. Auto menu cannot be a step in a multi-step cooking program.

## 10. QUICK START

### Tips for using the oven

Use this function to rapidly heat (100% microwave power) or cook your food. In the standby mode, press the START key and the oven will operate for 30 seconds. With each consecutive press of the START key, the operating time will be extended by 30 seconds.

**NOTE:** Pressing the START key again will prolong the cooking time by 30 seconds in all programs except in automatic mode, multi-step cooking, and in the auto defrost mode.

---

## 11. CHILD LOCK

**This function is used to prevent uncontrolled or inadvertent use of the oven by children. When the oven is locked, the relevant icon is displayed and the use of the oven is rendered impossible.**

To lock the oven, press the AUTO MENU and CLOCK keys simultaneously. When you hear a beep, the oven is locked and the key symbol appears on the display unit. As long as the oven is locked, all keys are ineffective.

To unlock the oven, press the AUTO MENU and CLOCK keys again. When you hear a beep, the oven is unlocked.

---

## 12. COUNTDOWN TIMER/MINUTE MINDER

**Use the countdown timer to set an alarm. The longest possible setting is 95 minutes.**

Example:

1. Press the CLOCK key. The display will start to flash.
2. Use the knob to set the desired time.
3. Confirm with the knob and the countdown will start.  
After the time has expired, the oven will beep.

**NOTE:** Setting the countdown timer or minute minder does not affect oven operation and cannot be used as a cooking timer.

---

## 13. SETTING THE ALARM AND KEY SOUND

**Use this function to set the loudness of the keys and other appliance sounds.**

Press the settings key and hold it for approximately 5 seconds. »VOL« will appear on the display. Use the knob to set the desired loudness (volume). Press the knob to confirm.

**NOTE:** When the setting »OFF« is selected, the keys will not produce any sound upon being pressed; all other sounds such as the alarm, countdown timer, end-of-program beep, and fault beep will operate as normal.

## CARE OF YOUR MICROWAVE OVEN

1. Turn the oven off and remove the power plug from the wall socket before cleaning.
2. Keep the inside of the oven clean. When food splatters of spilled liquids adhere to oven walls, wipe with a damp cloth. The use of harsh detergent or abrasives is not recommended.
3. The outside oven surface should be cleaned with a damp cloth. To prevent damage to the operating parts inside the oven, water should not be allowed to seep into the ventilation openings.
4. Do not allow the Control Panel to become wet. Clean with a soft, damp cloth. Do not use detergents, abrasives or spray-on cleaners on the control Panel.
5. If steam accumulates inside or around the outside of the oven door, wipe with a soft cloth. This may occur when the microwave oven is operated under high humidity conditions and in no way indicates malfunction of the unit.
6. It is occasionally necessary to remove the glass tray for cleaning. Wash the tray in warm sudsy water or in a dishwasher.
7. The roller ring and oven cavity floor should be cleaned regularly to avoid excessive noise. Simply wipe the bottom surface of the oven with mild detergent, water or window cleaner and dry. The roller ring may be washed in mild sudsy water or dishwasher. Cooking vapours collect during repeated use but in no way affect the bottom surface or roller ring wheels. When removing the roller ring from cavity floor for cleaning, be sure to replace it in the proper position.
8. Remove odors from your oven by combining a cup of water with the juice and skin of one lemon in a deep microwavable bowl. Microwave for 5 minutes, wipe thoroughly and dry with a soft cloth.

### ENVIRONMENT

Do not throw away the appliance with the normal household waste at the end of its life, but hand it in at an official collection point for recycling. By doing this, you help to preserve the environment.

# MOUNTING THE MICROWAVE OVEN

## INSTALLATION

1. Make sure all the packing materials are removed from the inside of the door.
2. Inspect the oven after unpacking for any visual damage such as:
  - Misaligned Door
  - Damaged Door
  - Dents or Holes in Door Window and Screen
  - Dents in CavityIf any of the above are visible, DO NOT use the oven.
3. This Microwave Oven weighs 14,2 kg and must be placed on a horizontal surface strong enough to support this weight.
4. The oven must be placed away from high temperature and steam.
5. DO NOT place anything on top of the oven.
6. DO NOT remove the turn -table drive shaft.
7. As with any appliance, close supervision is necessary when used by children.
8. Make sure that the AC outlet is easily accessible so that the plug can be removed quickly in an emergency. Otherwise, it should be possible to disconnect the device using a switch from the circuit. In this case, the existing provisions of the electrical safety standards are considered.

The product has to be correctly installed on earthed socket with a single-phase AC (230 V/50 Hz).  
**WARNING! THIS APPLIANCE MUST BE EARTHED!**
9. This oven requires 1.2 KVA for its input consultation with service engineer is suggested when installing the oven.

**CAUTION: This oven is protected internally by a 250V, 10 Amp Fuse.**

## SPECIFICATIONS

Power consumption.....	230V-50Hz, 1050W
Output power .....	700W
Grill heater .....	1000W
Operating Frequency .....	2450MHz
Outside Dimensions.....	595mm(W) x 388mm(H) x 320mm(D)
Oven Capacity .....	17 litres
Uncrated Weight .....	Approx. 14,2 kg
Noise level.....	Lc < 58 dB (A)



**This appliance is marked according to the European directive 2002/96/EC on Waste Electrical and Electronic Equipment (WEEE).**

**This guideline is the frame of a European-wide validity of return and recycling on Waste Electrical and Electronic Equipment.**

## RADIO INTERFERENCE

Microwave oven may cause interference to your radio, TV, or similar equipment. When interference occurs, it may be eliminated or reduced by the following procedures.

- Clean the door and sealing surface of the oven.
- Place the radio, TV, etc. as far away from your microwave oven as possible.
- Use a properly installed antenna for your radio, TV, etc. to get a strong signal reception.

WE RESERVE THE RIGHT TO MAKE ANY CHANGES THAT DO NOT AFFECT THE FUNCTIONALITY OF THE APPLIANCE.

# BUILT-IN CABINET

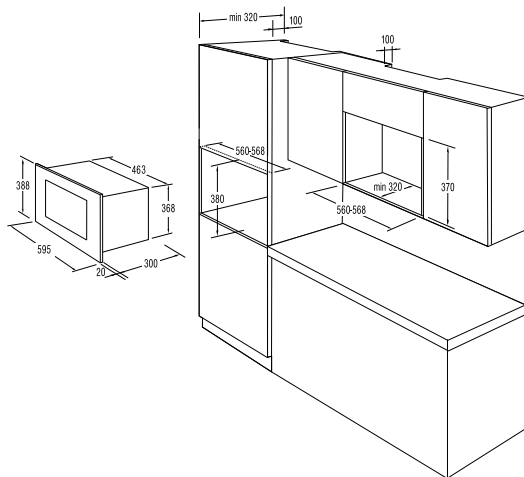

## PREPARE THE CABINET

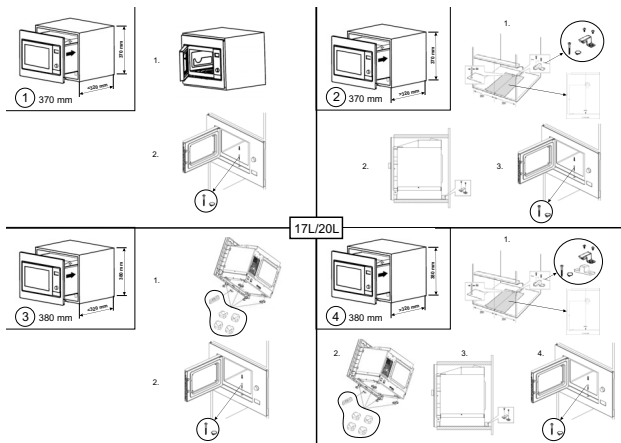



## BEFORE YOU CALL FOR SERVICE

1. If the oven will not perform at all, the information on the display does not appear or the display disappeared:
  - a) Check to ensure that the oven is plugged in securely. If it is not, remove the plug from the outlet, wait 10 seconds and plug it in again securely.
  - b) Check the premises for a blown circuit fuse or a tripped main circuit breaker. If these seem to be operating properly, test the outlet with another appliance.
2. If the microwave power will not function:
  - a) Check to see whether the timer is set.
  - b) Check to make sure that the door is securely closed to engage the safety interlocks. Otherwise, the microwave energy will not flow into the oven.

**If none of the above rectify the situation, then contact the nearest authorized service agent.**

**The appliance for household use for heating food and beverages using electromagnetic energy, for indoor use only.**

## GUARANTEE & SERVICE

If you need information or if you have a problem, please contact the Gorenje Customer Care Centre in your country (you find its phone number in the worldwide guarantee leaflet). If there is no Customer Care Centre in your country, go to your local Gorenje dealer or contact the Service department of Gorenje domestic appliances.

### **For personal use only!**

Additional recommendations for cooking with microwave and useful advices can be found on web side:

<http://www.gorenje.com>

**WISHES YOU A LOT OF PLEASURE WHILE USING YOUR APPLIANCE**

# **gorenje**