

MT **IE** **GB**

INSTRUCTIONS FOR USE, INSTALLATION, AND CONNECTION

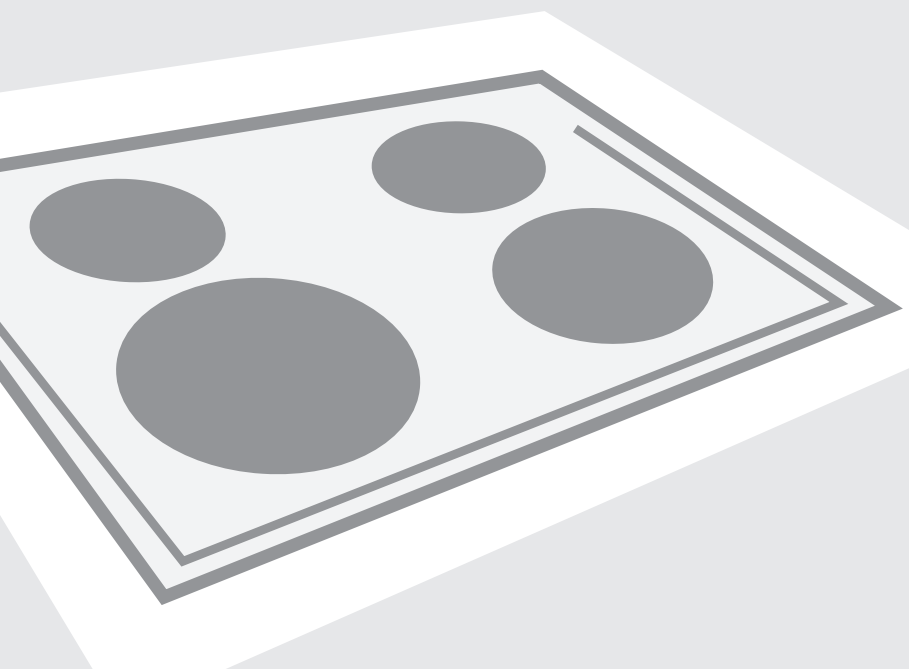

**GLASS CERAMIC INDUCTION BUILT-IN
COOKING HOB**

GLASS CERAMIC INDUCTION BUILT-IN COOKING HOB

Dear customer !

Built-in glass ceramic induction hob is intended solely for use in households. Our products are packed in environment-friendly materials which can be safely recycled, disposed of, or destroyed. Respective packaging materials are labeled accordingly. When the appliance is outdated and you intend to dispose of it, please make sure this is done in an environment-friendly manner. Take it to an authorized collection center for waste household appliances.

Instructions for use

Instructions for use have been prepared for the user, and describe the particulars and handling of the appliance. These instructions apply to different models from the same family of appliances, therefore you may find information and descriptions that may not apply to your particular appliance.

Installation instructions

The appliance should be connected to the power supply in accordance with the instructions from the chapter "Electrical connections" and in line with the standing regulations and standards. The connections should be carried out by a qualified personnel only.

Rating plate

The rating plate with basic information is located underneath the appliance.

Fire hazard protection

Appliances are allowed to be mounted on one side next to a high kitchen cabinet, the height of which may exceed that of the appliance. On the opposite side however, only a kitchen cabinet of equal height as the appliance is allowed.

TABLE

IMPORTANT - READ BEFORE USING THE APPLIANCE	4
Safety precautions.....	4
Warnings.....	5
CERAMIC-GLASS COOKTOP	6
Operating the cooking hob.....	6
Induction hotplate function principle.....	6
Appropriate cookware for induction hotplates.....	7
Power regulation	9
Energy saving tips	9
HOB CONTROL	10
Switching on the cooking hob	10
Turning hotplates on.....	10
Turning hotplates off.....	10
Powering off the cooking hob.....	11
Engaging the control unit lock / child safety lock.....	11
Remaining heat indicator.....	11
Power Boost	11
Operation time limit.....	12
Overheating safety device.....	12
Timer.....	13
Safety functions and error display.....	14
CLEANING AND MAINTENANCE OF CERAMIC-GLASS HOB	15
Cleaning.....	15
INSTALLATION	16
Important warnings.....	16
Installing the foam gasket.....	17
Worktop cutout dimensions.....	18
Installation procedure	18
Lower kitchen cabinet ventilation slots.....	19
Installation diagram.....	21
CONNECTION TO THE POWER SUPPLY	22
TECHNICAL INFORMATION	24
Rating plate.....	24

IMPORTANT - READ BEFORE USING THE APPLIANCE

Safety precautions

- This appliance can be used by children aged from 8 years and above and persons with reduced physical, sensory or mental capabilities or lack of experience and knowledge if they have been given supervision or instruction concerning use of the appliance in a safe way and understand the hazards involved. Children shall not play with the appliance. Cleaning and user maintenance shall not be made by children without supervision.
- **WARNING:** The appliance and its accessible parts become hot during use. Care should be taken to avoid touching heating elements. Children less than 8 years of age shall be kept away unless continuously supervised.
- **WARNING:** Danger of fire: do not store items on the cooking surfaces.
- **WARNING:** Unattended cooking on a hob with fat or oil can be dangerous and may result in fire. Never try to extinguish a fire with water, but switch off the appliance and then cover flame with a lid or a damp cloth.
- After use, switch off the hob element by its control and not rely on the pan detector.
- **WARNING:** If the surface is cracked, switch off the appliance to avoid the possibility of electric shock.
- Metallic objects such as knives, forks, spoons and lids should not be placed on the hob surface since they can get hot.
- Do not use steam cleaners or high-pressure cleaners to clean the cooking hob, as this may result in an electric shock.
- The appliance is not intended to be controlled by external timers or special control systems.
- Do not use the appliance outdoors.

Warnings

- The appliance may only be connected to the power mains by an authorized service technician or expert.
- Tampering with the appliance or non-professional repair thereof may result in risk of severe injury or damage to the product. Any repairs may only be carried out by an authorized service technician or expert.
- The appliance is intended solely for cooking. Do not use it for any other purpose, e.g. for room heating. Do not place empty cookware on the cooking zones.
- If another electrical appliance is connected to a AC power socket near the appliance, make sure the power cord does not come into contact with hot cooking zones.
- Do not store temperature-sensitive items underneath the appliance, such as cleaners or detergents, spray cans etc.
- Using the glass ceramic hob as a storage area may result in scratches or other damage to it. Never heat food in aluminium foil or in plastic containers on the cooking hob. Such foil or containers may melt which can result in a fire or damage to the cooking hob.
- Do not place objects like knives, forks, spoons, or lids on the induction cooking zone as they can become very hot.



The symbol on the product or on its packaging indicates that this product may not be treated as household waste. Instead it shall be handed over to the applicable collection point for the recycling of electrical and electronic equipment. By ensuring this product is disposed of correctly, you will help prevent potential negative consequences for the environment and human health, which could otherwise be caused by inappropriate waste handling of this product. For more detailed information about recycling of this product, please contact your local city office, your household waste disposal service or the shop where you purchased the product.

CERAMIC-GLASS COOKTOP

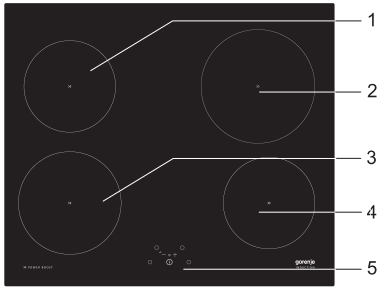

1. Induction hotplate rear left
2. Induction hotplate rear right
3. Induction hotplate front left
4. Induction hotplate front right
5. Hob control panel

Operating the cooking hob

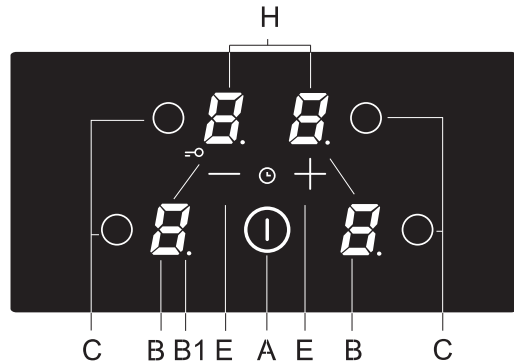

- A** Hob on/off sensor
- B** Power level/residual heat displays
- B1** The decimal point indicates the activated timer function
- C** Cooking zone selection sensors
- E** Sensor (-) and (+)
- H** Clock display

Induction hotplate function principle

- Four cooking zones are integrated into the glass ceramic hob. The hob surface is flat, without any edges along which dirt could accumulate.
- The hob is fitted with high power induction hotplates. Heat is generated directly at the bottom of the dish, where it is most needed, without any losses through the ceramic glass surface. This way the required extent of energy is considerably smaller compared to traditional heaters, which operate on radiation principle.

- Glass ceramic hotplate is not heated directly, but only by return heat transmitted by the dish. This heat figures as “remaining heat” after the hotplate is turned off. The induction hotplate generates heat from the induction coil, installed underneath the ceramic glass surface. The coil creates magnetic field at the bottom of the dish (which can be magnetized) which in turn originates whirling flows of current which then heat the hotplate.

IMPORTANT!

- In case sugar or other heavily sweetened substance is spilled on the hotplate, wipe it immediately and remove the sugar residues with a scraper although the cooking zone is still hot, otherwise the hotplate may be damaged.
- Avoid cleaning the cooktop while the cooking zones are still hot, as you may damage the hob.

Appropriate cookware for induction hotplates

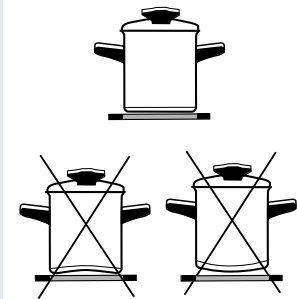

- Induction hotplate will function perfectly only if appropriate cookware is used.
- During cooking, cookware should be placed in the middle of the cooking zone.
- The appropriate cookware is the one which enables induction, for example steel, enamel or steel alloy cookware. Pots made from steel alloy with copper or aluminum bottom, or glass pots are inappropriate.
- When using a pressure cooker, keep an eye on it until the appropriate pressure level is reached and settled. First, switch the cooking zone to maximum power, then reduce the power on time in compliance with the pressure cooker manufacturer’s instructions.
- Only use cookware with flat bottom! Concave or convex (indented or bulging) bottom may impede the operation of overheat protection mechanism and the cooking hob may become too hot. This could lead to cracks in the glass surface and melting of the pan bottom. In case of damage resulting from the use of unsuitable cookware or overheating of empty, dried-out pots or pans (with nothing in them), the warranty is void.
- **When buying cookware, check if it bears the label “allows induction”.**



Only use cookware suitable for electric and induction cooking, with a:

- thick bottom (at least 2.25 mm)
- flat bottom.

Cooking zone	Minimum pan bottom diameter
Ø 160 mm	Ø 130 mm
Ø 180 mm	Ø 130 mm
Ø 200 mm	Ø 145 mm

MAGNET

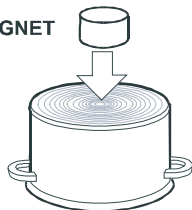

The magnet test

Using a small magnet, it is possible to check whether the bottom of your cookware can be magnetized. Use only cookware to which the magnet will stick.

Pan recognition

One of the many advantages of an induction cooking hob is the pan, or cookware, recognition. Even if there is no cookware on the cooking zone, or if a pan with a diameter smaller than that of the cooking zone, is placed on it, no heat is wasted. If the pan is much smaller than the cooking zone, it may not be perceived / recognized by the cooking zone. When the cooking zone is switched on, a symbol “U” will light up on the power level display. If a piece of cookware is placed on the cooking zone in the following ten minutes, it will be recognized by the cooking hob and the cooking zone will be powered up to the set cooking level.

As soon as the pan is removed from the cooking zone, power supply to the cooking zone is disconnected. If a pan with a diameter smaller than that of the cooking zone is placed on it, only the power required to heat up the pan in use will be supplied.

The cooking zone can be damaged:

- If an empty pan is placed on it.
- Before placing the pan on the cooking zone, wipe the pan bottom dry to enable the flow of heat and to prevent damage to the cooking zone.
- For cooking and frying, only use cookware that can be magnetized, i.e. steel, enamel-coated, or cast iron cookware. Only then will the induction cooking zone operate.

Power regulation

Cooking zone heat power can be set to ten different levels. The table lists some examples of use for each level.

Power setting	Purpose
0	Off, using remaining heat
1 - 2	Maintaining warm food, slow simmer of smaller quantities (lowest setting)
3	Slow simmer (continuation of cooking after a powerful start-up)
4 - 5	Slow cooking (continuation) of larger quantities, roasting larger chunks
6	Roasting, browning
7 - 8	Roasting
9	Cooking large amounts, searing/braising
P	"Power boost" setting for start of the cooking process; also suitable for very large amounts of food

Energy saving tips

- When buying cookware be careful in selecting size: pot diameter usually refers to the top edge of the dish, which is often larger than the dish bottom.
- Steam-pressure pots (economic pots), which use pressure in tightly sealed interior, are especially economic, and save both time and energy. Shorter cooking time leaves more vitamins in food.
- Always leave enough water in steam-pressure pots, otherwise it may result in overheating which may damage both the pot and the hotplate.
- Always cover the cookware with lids of appropriate size.
- Use such dish size to accommodate the quantity of food to be prepared. If you use excessively large pot for small amount of food, you will consume considerably more energy.

HOB CONTROL

Switching on the cooking hob

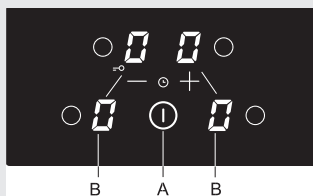

- After connecting the glass ceramic hob to the power mains, all symbols on the display will light up briefly. The cooking hob is then ready for operation.
- The cooking hob is fitted with electronic sensors which are activated by touching the designated surface areas with your finger for at least one second.
- Each time a sensor is activated, this is confirmed by a beep.
- Do not place any objects on the sensor area. Make sure the sensor area is always clean.

Touch the on/off sensor (A) and hold it for at least 1 second.

The cooking hob is activated »0« will appear on all power level displays (B) and decimal points (B1) will flash.

⚠ The following setting must be effected in the next ten seconds; otherwise, the cooking hob will be switched off.

Turning hotplates on

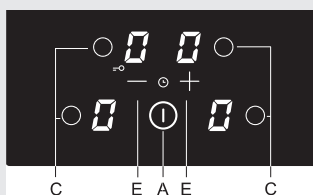

After you have switched on the hob with the on/off key (A), you may activate the desired cooking zone within the following 10 seconds.

- After you touch the sensor for the desired cooking zone (C), »0« on the relevant power level display will be lit more intensively.
- Touch the sensors »+« (E) and »-« (E) to set the power level (1-9-P). Touching the »-« sensor first will set the power level to 9.

⚠ Continuous pressing of »+« (C) or »-« (E) sensor the power level is automatically increased or reduced. Another procedure is to change power in steps is by intermediate touching of relevant sensors.

Turning hotplates off

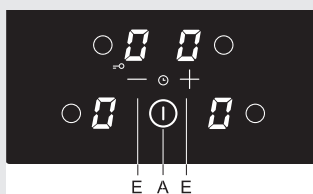

- First, select the cooking zone you wish to switch off.
- Touch the »-« sensor (E) to set the power level to »0«. If power level for all cooking zones is set to »0«, then the hob will be switched off after 20 seconds.

Powering off the cooking hob

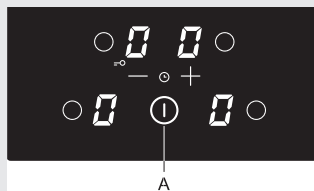

Engaging the control unit lock / child safety lock

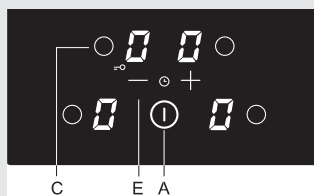

Remaining heat indicator



Power Boost

- The cooking hob may be switched off anytime by touching the on/off sensor (A). All settings will be deleted, except for the minute minder (see section »Timer«).

By activating the control unit lock, you can prevent the operation or use of the cooking zones. Thus, the control unit lock also works as a child safety lock.

Activating the child lock

- The hob must be switched off.
- Press the (A) sensor to switch on the cooking hob. Setting »0« will be indicated on all displays.
- Simultaneously press the (C) sensor for the rear left cooking zone and the »-« sensor (E) and hold them for approximately 3 seconds. After the beep, »L« will appear for a few seconds on all displays. The child lock is now activated.

Deactivating the child lock

- Press the (A) sensor to switch on the cooking hob. »H« will appear on all display units.
- Simultaneously press the (C) sensor for the rear cooking zone and the »-« sensor (E) and hold them for approximately 3 seconds. Setting »0« will be indicated on all displays. The child lock is now deactivated.

Glass ceramic hob also features remaining heat indicator »H«. Hotplates are not heated directly, but through return heat radiating from the dish. As long as the symbol »H« is on after the hotplate was switched off, the remaining heat may be used for warming up food or for melting. Even when the symbol »H« disappears, the hotplate may still be hot. Be careful of burns!

For rapid cooking, power boost can be activated for any cooking zone. This will allow you to rapidly heat large amounts of food using extra power.

Note: The front left and the rear right cooking zones feature the power boost function. In a cooking zone with this function, extra power is activated for five minutes; then, the zone switches to level 9.

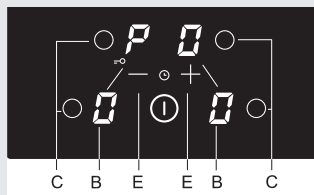

Activating the Power Boost

- Press the relevant sensor (C) to select the cooking zone. Use the »-« or »+« sensor (E) to choose the power level 9; then, press »+« immediately. »P« will appear on the power level display.

Deactivating the Power Boost

- Press the sensor for the selected cooking zone (C); then, immediately press the »-« sensor (E). The »P« symbol will disappear and the cooking zone will switch to power level 9.

Operation time limit

Safety switch off

Power setting	Hours lapse prior safety switch off
1	8
2	6
3	5
4	5
5	4
6	1,5
7	1,5
8	1,5
9	1,5
P	1,5

Maximum continuous operation of a particular hotplate is limited, and the duration is displayed in the above chart. When the hotplate is switched off by the safety mechanism, the indicator displays symbols »O«, or »H« in case there is any remaining heat left.

Example:

Set the cooking zone to level 6 and leave it to operate for a while. If the cooking zone setting is not changed, the security mechanism will switch off the zone after one and a half hour.

- The hob is fitted with a cooling fan which cools the electronic components during cooking. The fan may operate for a while even after the end of the cooking process.

Overheating safety device

- Induction cooking hob is also fitted with a built-in overheating protection device that protects the electronic parts from damage. The protection device operates at several levels. When the cooking zone temperature increases considerably, the cooking power is reduced automatically. If this is not enough, the power of currently heated cooking zones is reduced further or shut off entirely. In this case, »E2« will be indicated on the display. When the hob has cooled down, entire cooking hob power is again available.

Timer

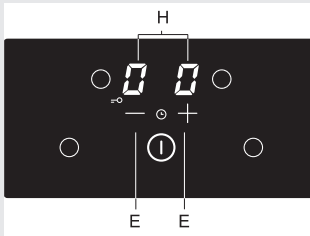

- Select the timer by simultaneously pressing the »-« and »+« sensor (E). Timer settings are displayed on the upper two display units (H), during which time the lower two display units are switched off.
- Timer setting is only displayed for 10 seconds; then, the display switches back to power level.

You may choose two operating modes:

- Shut-off timer** – the timer function is connected to the selected cooking zone. When the time expires, the cooking zone is switched off automatically.
- Minute minder** – timer function only has warning/alarm functionality. When the clock runs out, only an acoustic signal is emitted.

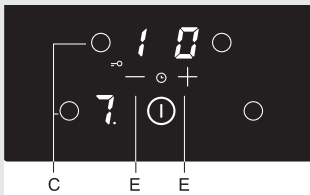

• Activating and setting the timer

Select the timer by simultaneously pressing the »-« and »+« sensor (E).

- If you have previously selected a cooking zone so that the corresponding display unit is lit more intensively, then the timer will be set for that cooking zone. The decimal point next to the power level indicates that the timer has been activated.
 - The timer (minute minder) can also be set when no cooking zone is selected, if you wish to be warned of something other than the cooking process. Activated timer (or minute minder) will be indicated with two flashing decimal points next to the display unit.
- Set the **cooking time** by pressing the »-« or »+« sensor (E). (Pressing »-« first will set the timer to 30 minutes. If you press and hold the sensor, the setting on the display will change at an increasing rate.)

Safety functions and error display

- **Value** can be set from 01 to 99 minutes. Shut-off timer can be set for each cooking zone.
- To check the **remaining time**, select the corresponding cooking zone and activate the timer function. Press the »-« or »+« sensor (E) to change the setting. (Press the »-« and »+« sensor (E) simultaneously and sequentially to choose between active settings.)
- **When the set time expires**, »00« will flash on the display; in addition, relevant decimal point will flash at the shut-off timer. A short beep will be heard. To acknowledge and stop the beep, press any key; after 2 minutes, the beep will end automatically.

The cooking hob is fitted with overheating protection sensors. If the temperature rises too high, individual cooking zones or even the entire cooking hob can be temporarily switched off automatically.

Error, possible cause, solution

- Continuous beep and Er03 flashing on the display.
 - Water spilt over sensor surface, or an object placed over the sensors.
Wipe the sensor surface.
- Flashing E/2
 - Cooking zone has overheated. Wait for the cooking zone to cool down.
- E/3 flashes
 - Unsuitable cookware that lacks ferromagnetic properties. Use another pot or pan.



In case of an operation failure or if the fault / error indication does not disappear, disconnect the cooking hob from the power mains for a few minutes (undo the fuse or turn of the main switch); then, reconnect it to the power mains and turn on the main switch key.

If the problems persist, call a service technician.

CLEANING AND MAINTENANCE OF CERAMIC-GLASS HOB

Cleaning

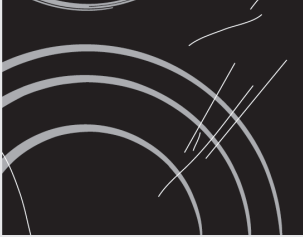

Figure 1



Figure 2



Figure 3



Figure 4

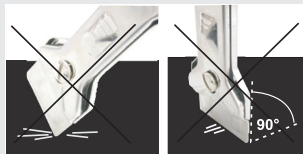

After each use of the **glass-ceramic hob**, wait for it to **cool down** and clean it; otherwise, even the smallest food residue will be burnt onto the hot surface next time you use the appliance. **For regular cleaning and maintenance of the glass-ceramic surface, use special conditioning agents** which form a protective layer on the surface, shielding it from dirt. Before each use, wipe any dust or other particles from the hob surface and pan bottom as these could scratch the surface (Figure 1).

Careful: steel wool, abrasive sponges, and abrasive detergents can scratch the hob surface. Glass ceramic surface can also be damaged by aggressive sprays and inappropriate or insufficiently shaken (mixed) liquid cleaning agents (Figure 1 and Figure 2).

Signage may be worn when using aggressive or abrasive cleaners or cookware with damaged bottom (figure 2).

Light stains can be removed by a damp soft cloth; then, wipe the surface dry (Figure 3).

Water stains can be removed using a mild solution of vinegar; however, do not use this solution to clean the frame (only with some models, as it may become dull. Do not use aggressive sprays or decalcification agents (Figure 3).

Heavier stains can be removed using special agents and utensils for cleaning the glass-ceramic hobs. When using these products, follow the instructions provided by their respective manufacturers.

Make sure any residues of cleaning agents are thoroughly removed, as they could damage the glass-ceramic hob when the cooking zones heat up (Figure 3).

Remove stubborn and burnt residues with a scraper (figure 4). Be careful when handling the scraper to prevent injury.

! Only use the scraper when dirt cannot be removed with a wet cloth or special cleaners for glass ceramic surfaces.

Hold the scraper at the correct angle (45° to 60°). Gently press the scraper against the glass and slide it over the signage to remove the dirt. Make sure the plastic handle of the scraper (in some models) does not come into contact with a hot cooking zone.

! Do not press the scraper perpendicularly against the glass and do not scratch the hob surface with its tip or blade.

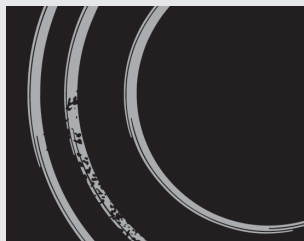

Figure 5

Sugar and sugar-laden food may permanently damage the glass-ceramic surface (Figure 5); therefore, they should be removed from the glass-ceramic surface as soon as possible, although the cooking zone may still be hot (Figure 4). **Any change in the color of the glass-ceramic surface** does not affect its operation or the stability of the surface. Such discolorations are mostly a result of burnt food residues or use of cookware made of materials such as aluminum or copper; these stains are difficult to remove.

Warning: All damage described above predominantly relates to the aesthetics, i.e. appearance of the appliance and do not affect its functionality directly. Such errors cannot be the subject of a warranty claim.

INSTALLATION

Important warnings

- Installation of the appliance into a kitchen worktop and its connection to the power mains may only be performed by an adequately qualified technician.
- Veneer or other finish of the piece of kitchen furniture into which the hob is to be built in should be treated with heat resistant glue (100°C); otherwise, the worktop finish may be discolored or deformed.
- Cooking hob is dimensioned to be built into the worktop over a piece of kitchen furniture, with a width of 600 mm or more.
- After installation, the front two fastening elements should be freely accessible from below.
- Hanging, or wall-mounted kitchen elements should be installed high enough not to interfere with the work process.
- The distance between the cooking hob and the kitchen hood should be no less than indicated in the instructions for kitchen hood installation. The minimum distance is 650 mm.
- The distance between the appliance edge and the adjacent tall kitchen furniture element should amount to no less than 40 mm.
- Use of massive wood decoration plates or boards on the worktops behind the cooking hob is permitted, if the minimum distance remains the same as indicated in the installation drawings.
- Minimum distance between the built-in cooking hob and the rear wall is indicated on the installation drawing.

Installing the foam gasket

Before inserting the appliance into the opening in the kitchen worktop, the supplied foam gasket must be attached to the lower side of the glass ceramic (glass) cooking hob (see figure above). **Do not install the appliance without the foam gasket!**

The gasket should be attached to the appliance in the following way:

- Remove the protective film from the gasket.
- Then, attach the gasket to the lower side of the glass, approximately 2-3 millimetres from the edge (as shown in the figure). The gasket must be attached along the entire length of the glass edge and should not overlap at the corners.
- When installing the gasket, make sure that the glass does not come into contact with any sharp objects.

NOTE!

On some appliances the gasket is already installed!

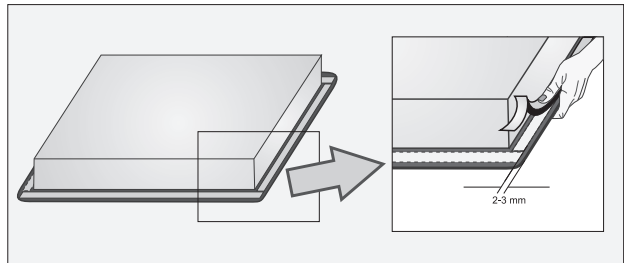

Worktop cutout dimensions

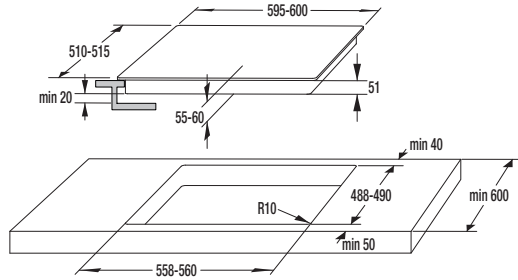

- Cooking hobs can be installed into worktops that are 30 to 50 mm thick.
- If the board is thicker than 40 mm, its inner edge should be trimmed, or ground (Figure A). Thus, sufficient air circulation will be provided.
- If the thickness of your counter top exceeds 30 mm, then the opening for the hob should be made in the middle of the oven, with sufficient clearance from the front edge of the counter top so that the induction hob does not touch the oven shield.
- If you wish to install the induction hob into an existing opening, make sure if this is possible given the required installation dimensions (installation depth of 54 mm).

Installation procedure

- Worktop must be placed absolutely horizontal.
- Suitably protect the edges of the cut aperture.
- Connect the cooking hob to the mains power supply (see instructions for the connection of the cooking hob to mains power supply).
- Insert the hob into the cut aperture.

Lower kitchen cabinet ventilation slots

- To enable normal operation of electronic components of the induction hob, sufficient air circulation must be provided.

A Lower kitchen cabinet with a drawer

- An opening at least 140 mm high must be provided on the back wall of the cabinet, along its entire width. Furthermore, a minimum of 6 mm clearance must be provided at the front side, along the entire width of the cabinet.
- The hob is fitted with a fan located in its lower part. In case there is a drawer underneath the kitchen cabinet, no small objects or paper must be kept there, as these could be sucked in by the fan, causing damage to the fan or the entire cooling system. Aluminum foil and inflammable substances or liquids (e.g. sprays) should also not be stored in such drawers or placed near the hob. Danger of explosion! There should be a clearance of 20 mm between the drawer contents and the fan entry slots.

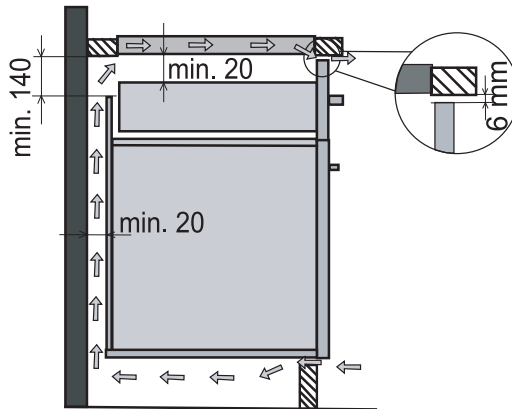

B Lower kitchen cabinet with an oven

- Installing the oven under an induction hob is possible with oven types EVP4.., EVP2.., which are fitted with a cooling fan. Before installing the oven, the rear wall of the kitchen cabinet should be removed. Furthermore, a minimum of 6 mm clearance should be provided at the front side, along the entire width of the cabinet.

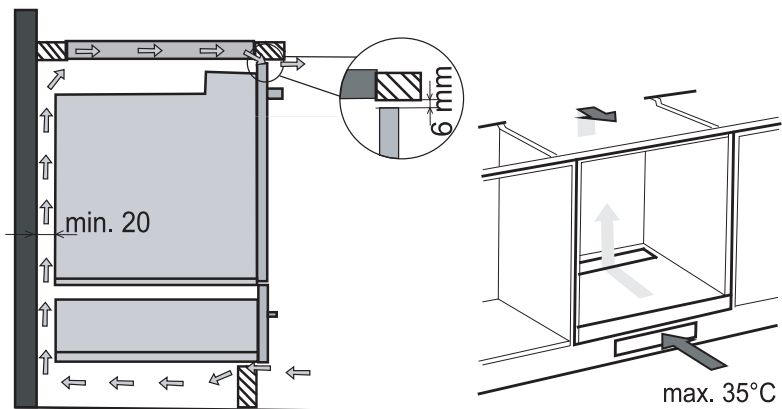

Installation diagram

The appliance is designed for two-phase connection; it can also be connected to a single phase.

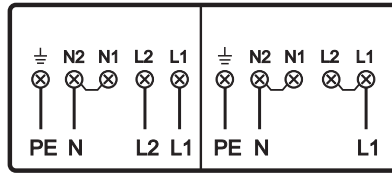

- **Two-phase connection**

Insert the jumpers between N1 and N2.

- **Single-phase connection**

Insert one jumper between N1 and N2 and one jumper between L1 and L2.

Connection may be carried out by means of:

- rubber coated connection cables, model H05 RR-F 4x1,5 with yellow-green earthing cable;
- PVC insulated connection cables, model H05 VV-F 4x1,5 with yellow-green earthing cable; or any other suitable cables.

- Connections may be carried out by a qualified technician only. The earthing protection must comply with the standing regulations.
- Connection terminals are revealed when the connection box cover is removed.
- Prior any attempted connection check that the voltage indicated on the rating plate is in line with your home power supply.
- The rating plate is located underneath the appliance.
- The appliance is manufactured for use with the power supply voltage 230 V ~.
- The electric wiring should be equipped with a circuit breaker able to isolate the appliance from the mains in all points, with the distance between terminals of at least 3 mm in open position. This may be done by means of fuses, safety switches, etc.
- The connection should be selected in accordance with the declared charge capacity of the mains and the fuse power.
- Such appliances are allowed to be mounted on one side next to a high kitchen cabinet, the height of which may exceed that of the appliance. On the opposite side however, only a kitchen cabinet of equal height as the appliance is allowed.
- Upon the completion of installation, live wires and isolated cables must be adequately protected against accidental touching.

ATTENTION !

Before attempting any repairs on the appliance, disconnect the power supply. In accordance with the mains voltage the appliance should be connected in line with the attached diagram. The earthing wire (PE) must be connected to the terminal marked with the earthing symbol \perp .

The connection cable must lead through the relief safety device, protecting it from accidental pulling out. Upon the completion of installation switch all the hotplates on for about 3 minutes to check the proper functioning.

Use a flat screwdriver to open the connection clip. When connecting the appliance, use the jumper connectors supplied.

Single-phase connection with total power limiter (only in model with four cooking zones and without the bridge function)

- If your home main fuse does not allow 32-ampere current, then the function of total power limiter can be activated on the hob so that the current never exceeds 16 A.
- If you activate the total power limiter, then the power of each cooking zone may only be increased until total power reaches the limit. When the limit is reached, the hob will beep and the setting display will flash.
- The setting can be activated within two minutes after connecting the hob to the power mains (the appliance must be switched off and unlocked).
- Simultaneously press all keys (sensors) for selecting the cooking zones and hold them for 3 seconds until you hear a short beep. »Hi« will appear on the display. This stands for »High« power.
- Press the »-« or »+« sensor to change the setting to »Lo«. This stands for »Low« power.
- To confirm the setting, touch all keys for selecting the cooking zones again and hold them for 3 seconds. A short acoustic signal will be emitted and the display will go blank..
- The low power setting is now stored. if you wish to change this setting again, the appliance must be disconnected from the power mains for a few seconds.

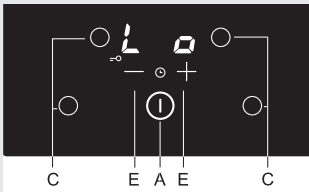
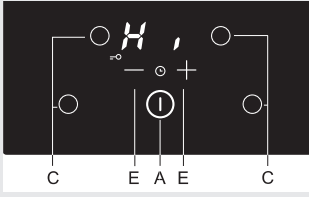

Note: To interrupt the setting procedure, press the on/off key (A); if no key is pressed, the process is cancelled automatically after one minute. The previous setting will remain active.

Example: If two cooking zones are set to »P« level, the other two cooking zones cannot be used.

TECHNICAL INFORMATION

Rating plate

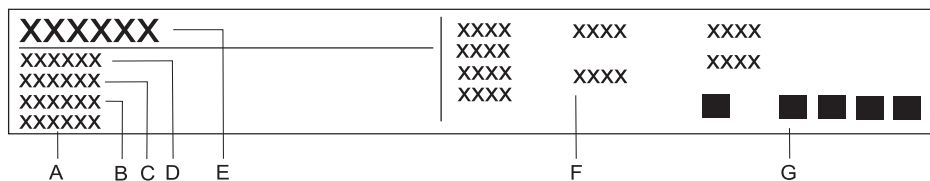

- A** Serial number
- B** Code
- C** Model
- D** Type
- E** Trademark
- F** Technical information
- G** Compliance indications / symbols

WE RESERVE THE RIGHT TO ALTER THE SPECIFICATIONS WITH NO INFLUENCE TO THE OPERATION OF THE APPLIANCE.

Instructions for use of the appliance can also be found on our website at www.gorenje.com / < <http://www.gorenje.com> / >

