

Side by Side Refrigerator

Disposal of Used Electrical & Electronic Equipment



The meaning of the symbol on the product, its accessory or packaging indicates that this product shall not be treated as household waste. Please, dispose of this equipment at your applicable collection point for the recycling of electrical & electronic equipments waste.

In the European Union and Other European countries there are separate collection systems for used electrical and electronic product. By ensuring the correct disposal of this product, you will help prevent potential hazards to the environment and to human health, which could otherwise be caused by unsuitable waste handling of this product. The recycling of materials will help conserve natural resources.

Please do not therefore dispose of your old electrical and electronic equipment with your household waste.

For more detailed information about recycling of this product, please contact your local city office, your household waste disposal service or the shop where you purchased the product.

SAFETY WARNING



This appliance contains a certain amount of isobutane refrigerant (R600a) a natural gas with high environmental compatibility that is, however, also combustible.

When transporting and installing the appliance, care should be taken to ensure that no parts of the refrigerating circuit are damaged.

Refrigerant squirting out of the pipes could ignite or cause eye injury. If a leak is detected, avoid any naked flames or potential sources of ignition and air the room in which appliance is standing for several minutes.

- In order to avoid the creation of a flammable gas-air mixture if a leak in the refrigerating circuit occurs, the size of the room in which the appliance may be sited depends on the amount of refrigerant used. The room must be 1 m³ in size for every 8g of R600a refrigerant inside the appliance. The amount of refrigerant is shown on the identification plate inside the appliance.
- Never start up an appliance showing any signs of damage. If in doubt, consult your dealer.

RoHS(Directive 2011/65/EU) Compliant



This product is environmentally sound and sustainable free from Pb, Cd, Cr+6, Hg, PBBs and PBDEs restricted in accordance with the Directive.

Refrigerant Information

Refrigerant	R-600a
Charge	0.064kg
Blowing Agent	C-pentane

Observe Ambient Temperature

This refrigerator is designed to operate in ambient temperature specified by its category, which is marked on the rating plate

Climatic category	Ambient temperature from...to
SN	10°C to 32°C
N	16°C to 32°C
ST	16°C to 38°C
T	16°C to 43°C

NOTE

Internal temperature may be affected by such factors as the location of the refrigerator, ambient temperature and frequency of the door opening.

Contents

Be sure to keep for safety!.....	1~2
Installation guide	3
Installation preparation	4
Door removal/replacement	5~6
Refrigerator Leveling & Door Adjustment (If needed).....	7
How to install Water Line	8~9
Control panel.....	10
Temperature control	11
How to use the interior parts.....	12~13
How to use the dispenser	14
How to use the automatic ice maker	14
How to adjust the automatic ice maker water supply	15~16
Refreshment compartment.....	16
Care & cleaning	17~18
Before you call for service.. ..	19
Something strange?	
Don't worry. Here is the answer.	20

Be sure to keep for safety!

* Read these safety instructions thoroughly and carefully before using. Please keep this user guide on hand for future reference.



Indicates the possibility of danger of death or serious injury



Indicates the possibility of risk of personal injury or material damage.

Other Signs



DO NOT remove or disassemble!



Be sure to unplug from outlet/mains!



NO. DO NOT...



Be sure to keep and follow!



Caution

1. If the supply cord becomes damaged, it must be replaced by a qualified person in order to avoid a hazard.
2. This appliance is not intended for use by persons (including children) with reduced physical, sensory or mental capabilities, or lack of experience and knowledge, unless they have been given supervision or instruction concerning use of the appliance by a person responsible for their safety.

WARNING



Never let the power cord be crushed by the refrigerator itself or other (heavy) objects. Never bend power cord excessively.

- If the cord is damaged or peeled, it can be a cause of fire and electric shock.



Do not plug several appliances into the same wall outlet.

- It can be a cause of overheating and/or fire. Use an exclusive grounding receptacle for the refrigerator.



Never hold the power cord or plug with wet hands.

- There is a risk of electric shock.



Never use a damaged power cord or plug, or loose main socket.

- There is a risk of fire, electric shock or serious injury.



Be sure to ground. Check if your wall outlet is grounded (earthed).

- There is a risk of electric shock hazards.



Never unplug by pulling only the power cord wire. Always grip the plug firmly.



Let the cord from the plug outlet be directed downwards.

- If it is directed up, the cord near the plug is bent and can be damaged, which can cause an electric shock or fire.



Do not install the refrigerator on a wet floor or in a place with excessive humidity and moisture.

- Electric insulation gets weakened, resulting in a risk of electric shock hazards.



Never let the power cord touch or pass over heating appliances.

- Power cord can be damaged, resulting in a risk of electric shock hazards.



Check if plug is loose from the wall outlet.

- Electric insulation gets weakened, resulting in a risk of electric shock hazards.



Never pour or spray water into the refrigerator (both interior and exterior).

- Electric insulation gets weakened, resulting in a risk of electric shock hazards.



Do not place containers with water or liquid on top of refrigerator.

- Water can spill into the refrigerator and can cause electric shock hazards or damage.



Do not move or remove compartment shelves/pockets while foods and containers are on them.

- Hard containers (of glass, metal etc.) can fall to hurt you and can break glass shelf and interior parts.



Never repair or disassemble or amend the refrigerator on your own.

- There is a risk of personal injury or damage to the refrigerator. It is recommended that any service be carried out by a qualified person.

 **Never store any flammable gas or liquid in the refrigerator.**

 **Never use flammable gas, benzene, thinners, gasoline, spray etc. near the refrigerator.**

- There is a risk of fire, explosion and personal injury or damage.

 **If a gas leak is found near the refrigerator or in the kitchen, ventilate it immediately without touching the power plug or refrigerator.**

 **Do not store medicine or academic research samples which require strict temperature control in the refrigerator.**

 **Never insert fingers or hands into the bottom of the refrigerator, especially into the bottom at the back.**

- You can be hurt by sharp metal edges or can receive an electric shock.

 **Do not change fuse or LED light on your own. Call the service agent to change them.**

 **When you find the power cord damaged or cut, call the service agent immediately.**

 **When you get rid of your old refrigerator, be sure to remove the doors first.**
• Children can be entrapped and suffocated in an abandoned refrigerator.

 **Keep ventilation openings, in the appliance enclosure or in the built-in structure, clear of obstruction.**

 **Do not use mechanical devices or other means to accelerate the defrosting process, other than those recommended by the manufacturer.**

 **Do not use electrical appliances inside the food storage compartments of the appliance.**

 **Do not damage the refrigerant circuit.**

 **To avoid a hazard due to instability of the appliance, it must be fixed in accordance with the instructions.**

 **The ice-maker in the freezer can be only replaced by the manufacturer or the service agent.**

 **When the freezer door is open, do not press the dispenser lever.**

 **Connect to portable water supply only.**

 **Do not let children step on the cabinet shelves or vegetable cases.**

 **Keep Children away from packaging or packaging parts.**

- There is a risk of suffocation from cardboard boxes and plastic films.

 **Do not let children hang on the refrigerator doors.**

- Refrigerator can fall and harm them.

CAUTION

 **Be sure to unplug the refrigerator when it is not going to be used for a long time.**

 **Never touch foods and containers especially of metal with wet hands in the freezer compartment.**

- You can be hurt by chilblains or cold burns.

 **Never eat any decayed or deteriorated food at all.**

- Foods stored too long in the refrigerator can deteriorate and become decayed.

 **Never place bottles and containers of glass in the freezer compartment.**

- Glass containers and bottles can break and can hurt you.

 **When moving the refrigerator (horizontally or tilted), more than 2 people are required to hold it. (One to hold top back handles, the other to hold the bottom holder.)**

If other parts are held instead, it is very dangerous and likely to slip.

 **Be sure to turn up the wheel first before moving the refrigerator.**

- The wheels can damage or scratch the floor. If you are moving it for a long distance, never forget to fasten the interior parts tightly with tapes. Otherwise, the parts can collide and break each other.

Installation Guide

* Read these safety instructions carefully before use and follow precautions for your safety.



Precautions in installation and power connection

■ To prevent fire, electric shock or leakage.

❶ Never install the refrigerator on a wet, watery floor or where water can gather easily.

❷ Check the following before power connection.

- Connect power plug only to a grounded wall socket (an earthed mains).
- Do not plug refrigerator power together with other appliances to the same socket.

❸ Do not use an adapter plug or an extension cord.

❹ Do not let the power cord be crushed by other (heavy) objects.

- If you hear a strange noise, strong chemical odour or find smoke etc. from the refrigerator after the power is plugged in, pull out the plug immediately and call a service agent.
- Wait about 5 minutes before you plug-in again in order to prevent any damage to the compressor and electrical devices of the refrigerator.
- Wait 2~3 hours until the inside gets cold enough after the first power plug-in, then store foods inside. (There can be some smell of plastic parts on initial operation of the refrigerator after plugging in. The smell fades away as the refrigerator works and doors are opened and closed.)



Precautions in use

■ To prevent personal injury, fire, electric shock etc. read this user guide carefully before use and keep it at hand for reference.

■ Accessories

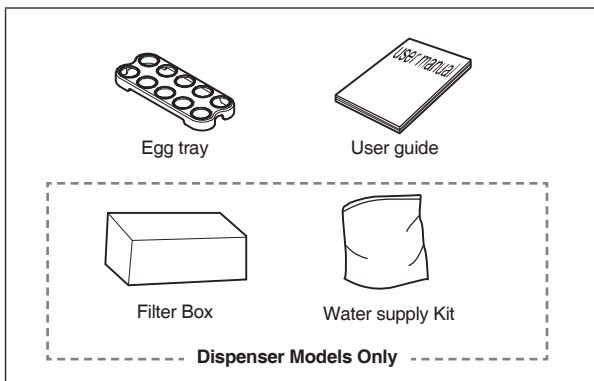

Install the door handles

After final installation and door levelling, install the fridge door handles.



Both handles are installed in the same way.

- Position one of the door handles into the guides on the door, the set screws on the handle needs to point to the centre of the fridge freezer.

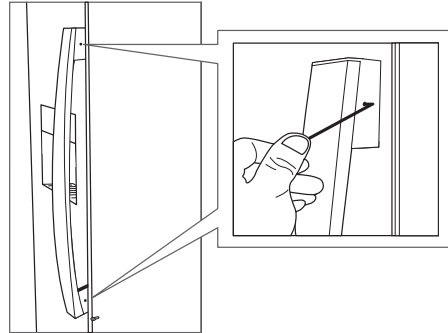

- Using the supplied Allen key tighten the two set screws (turn in a clockwise direction).
- Repeat this process for the other door handle.

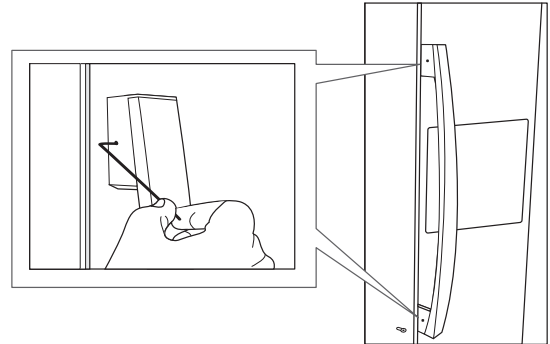

Installation Preparation

Dimensions (including Door Handles)

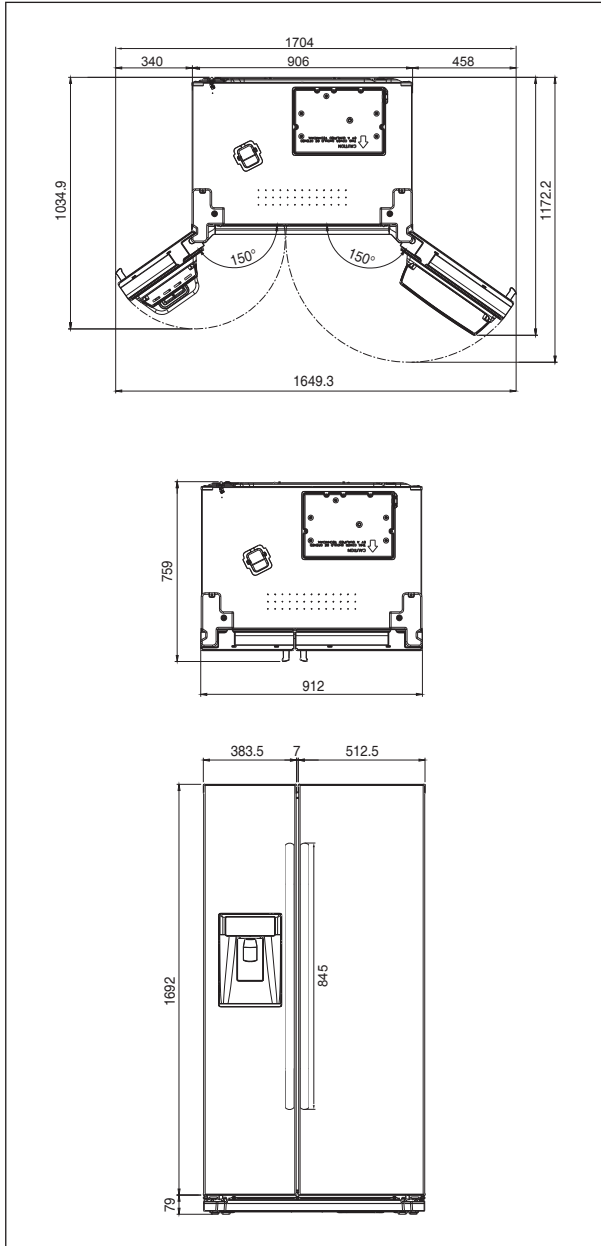

Check if the refrigerator can pass a doorway or enter a door first.

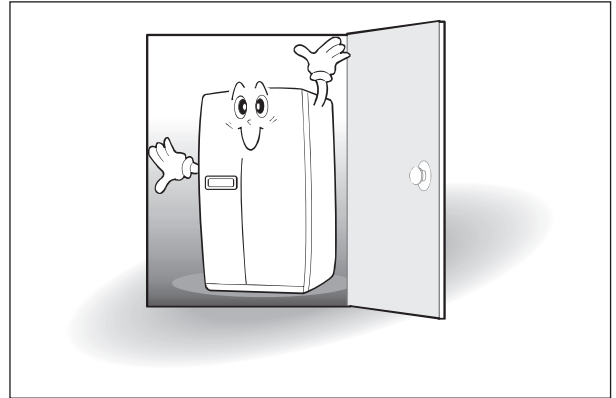

Find a suitable place to install

Ensure sufficient space from the back of refrigerator to the wall for free air ventilation.

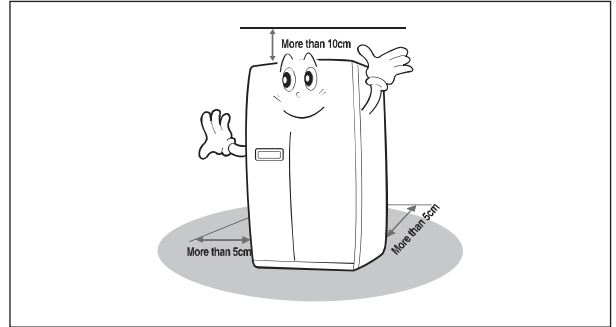

Avoid direct sunlight.

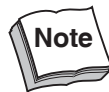
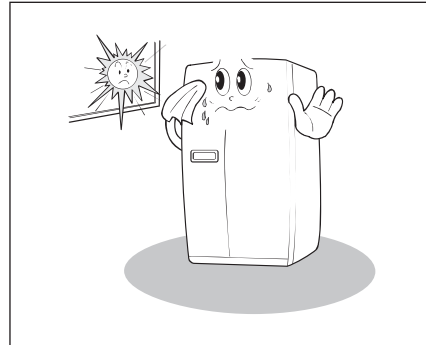

Once the installation place is ready, follow the installation instructions.

If the surrounding temperature of the refrigerator is low (below 5°C), foods can be frozen or the refrigerator can function abnormally.

Door removal/Replacement

If the refrigerator can not pass through a door during installation, follow these steps.

(This guide refers to several models. The real features are model dependent.)

Removing Refrigerator Door

* Remove front bottom cover first, if it is attached.

- 1 Unscrew top hinge cover with a screwdriver. Insert a thin screwdriver into the side groove of the cover to remove.

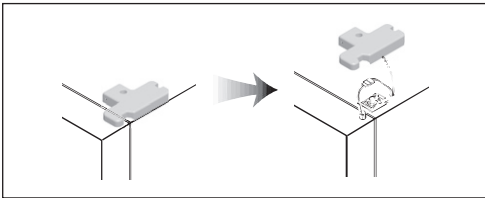

- 2 Turn top hinge fastener counterclockwise 3-4 times. Disconnect harness wires (model dependent).

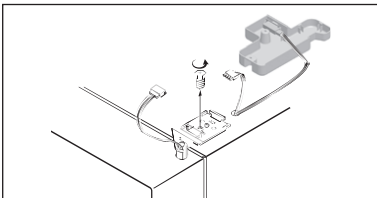

- 3 Lift up the front of hinge to remove. (After the hinge is removed the door can fall down forward. Be careful!)

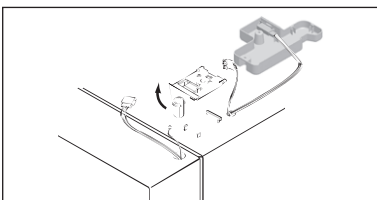

- 4 Lift the door straight up to remove.

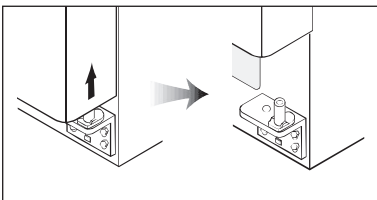

Removing Freezer Door

- 1 Pull out bending tube guide and the left water tube. (Dispenser Models Only)

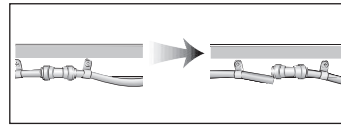

- 2 Unscrew top hinge cover with a screw driver.

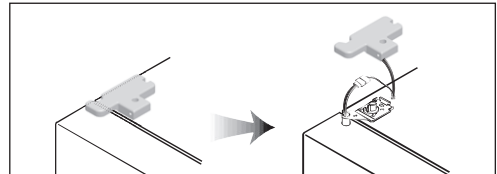

- 3 Turn top hinge fastener counterclockwise 3-4 times. Disconnect the harness wires.

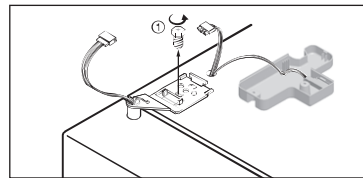

- 4 Lift up the front of hinge to remove. (After the hinge is removed the door can fall down forward. Be careful!)

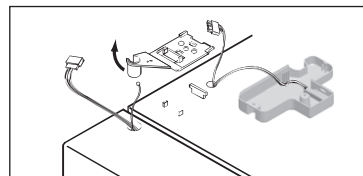

- 5 Be careful not to damage the water line when removing the door.

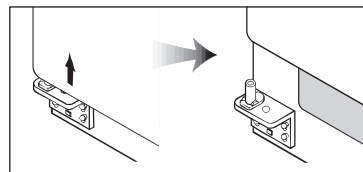

Replacing Refrigerator Door

- 1 Insert the bottom hole of the refrigerator door straight into the bottom hinge pin.

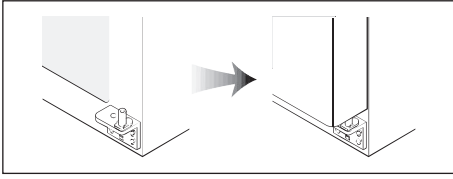

- 2 Let the top of the door close and insert the top hinge pin to the top hole of the refrigerator door. (Insert the back of hinge to the groove of protrusion first, then front to the top hole of door.)

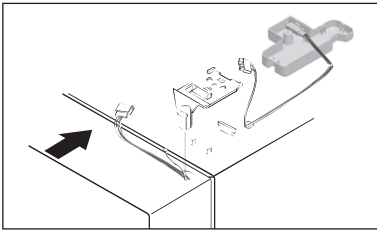

- 3 Turn the hinge fastener tightly to the end. Connect harness wirings (model dependent) and screw down the ground wire. Click and screw the top hinge cover.

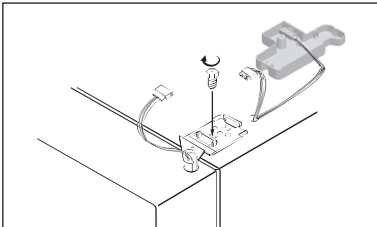

Replacing Freezer Door

- 1 Insert the water tube into the hole of the bottom hinge pin first (Dispenser Models Only). Insert the bottom of freezer door into the bottom hinge pin.

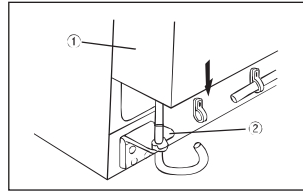

- 2 Let the top of the door close and insert the top hinge pin to the top hole of the freezer door. (Insert the back of hinge to the groove of protrusion first, then front to the top hole of door.)

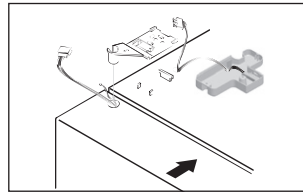

- 3 Turn the hinge fastener tightly to the end. Connect harness wirings and screw ground wire.

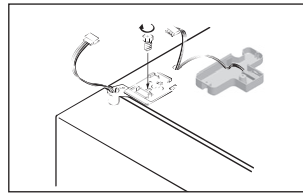

- 4 Click and screw the top hinge cover.

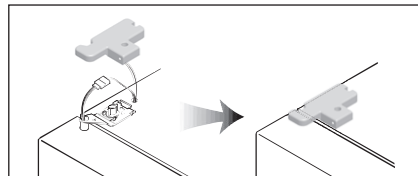

- 5 Fasten the bending tube guide and insert the water tube far into the coupling. (Dispenser Models Only)

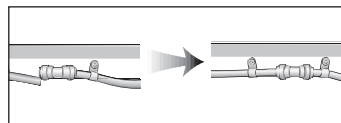

Refrigerator Leveling & Door Adjustment (If needed)

* The refrigerator must be level in order to maintain optimal performance and desirable front appearance. (If the floor beneath the refrigerator is uneven, the freezer and refrigerator doors may look unbalanced.)

In case freezer door is lower than refrigerator door...

1 Insert a screw driver (flat tip) into a groove of the left wheel (bottom of freezer) and turn it clockwise until the door is balanced. (Clockwise to raise freezer door, counterclockwise to lower.)

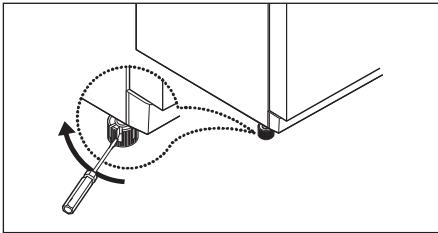

* If the freezer door is not balanced by step 1, then follow the next steps.

2 Open the doors, unscrew the front cover and remove, if it is attached.)

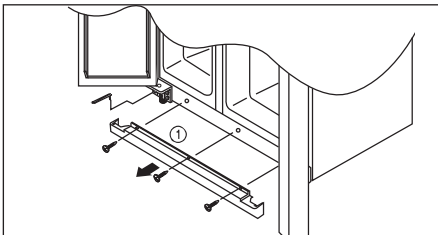

3 Insert a spanner (part A) into the hinge nut (part 1) and unscrew the nut by turning clockwise.

4 Insert a spanner (part B) into the hinge nut (part 2) and turn clockwise to lower the door.

5 If the door is aligned, fasten the nut (part 1) tightly by turning counter-clockwise

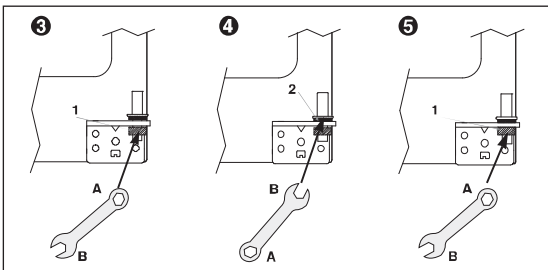

In case refrigerator door is lower than freezer door...

1 Insert a screw driver (flat tip) into a groove of the right wheel (bottom of refrigerator) and turn it clockwise until the door is balanced. (Clockwise to raise refrigerator door, counterclockwise to lower.)

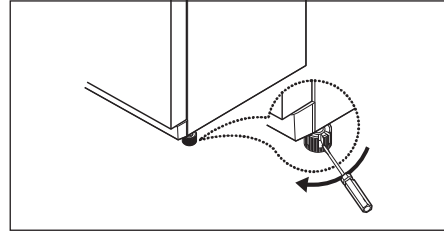

* If the freezer door is not balanced by step 1, then follow the next steps.

2 Insert a spanner (A part) into the hinge nut (1 part) and unscrew the nut by turning clockwise.

3 Insert a spanner (B part) into the hinge nut (2 part) and turn counter-clockwise to tighten the door.

4 If the door is aligned, fasten the nut (1) tightly by turning.

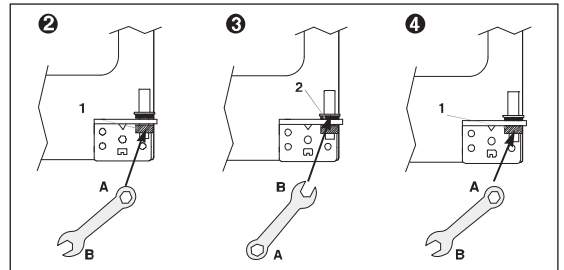

■ Front Cover

After installation and/or door leveling, fasten front cover with screws. (Remove the screws on the front bottom panel first. Click and screw the cover.)

⚡ Caution

- The front of the refrigerator needs to be just a little higher than the back for easy door closing, but if the wheel is raised too much for door balance, i.e. the front of refrigerator is much higher than the back, it can be difficult to open the door.

How to install Water Line (Dispenser models only)

- The water pressure should be 2.0~12.5 kgf/cm² (1.96~12.26 Bar) or more to run the automatic icemaker.
 - Check your tap water pressure; if a cup of 180cc is full within 10 seconds, the pressure is OK.
- When installing the water tubes, ensure they are not close to any hot surfaces.
- The water filter only filters water; it does not eliminate any bacteria or microbes.
- If the water pressure is not sufficient to run the icemaker, call the local plumber to get an additional water pressure pump.
- The filter life depends on the amount of use. We recommend you to replace the filter at least once every 6 months.
 - When attaching the filter, place it for easy access (removing & replacing)
- After installation of refrigerator and water line system, select [WATER] on your control panel and press it for 2~3 minutes to supply water into the water tank and dispense water.
- Use plumbers thread sealing tape on every connection of pipes/tubes to ensure there is no water leaks.
- The water tube should be connected to the cold water line.

■ WATER SUPPLY KIT

* Check the parts below for installing water supply. Some other necessary parts are available at your local service agents.

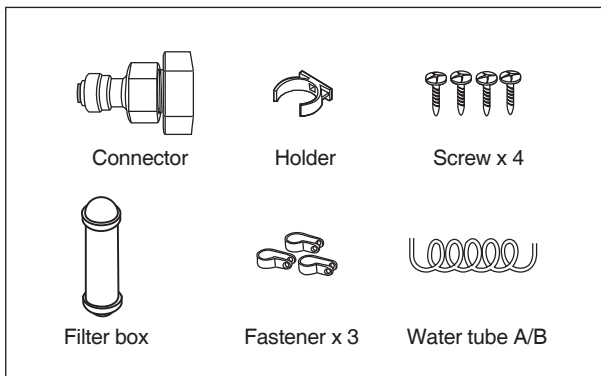

Installation Procedure (Dispenser models only)

1. Join Connector to the tap water line

Figure A

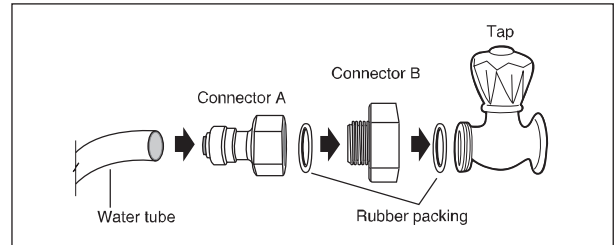
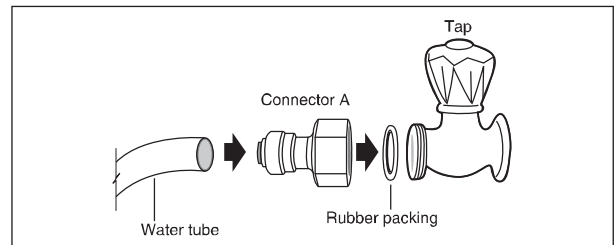

Figure B



! Place the rubber packing inside the tap connector and screw onto the water tap.

2. Get ready to install the Water Filter

- Measure an approximate distance between the filter and the water tube and cut the tube off filter vertically.
- Connect the tubes to the filter as the figure shows.

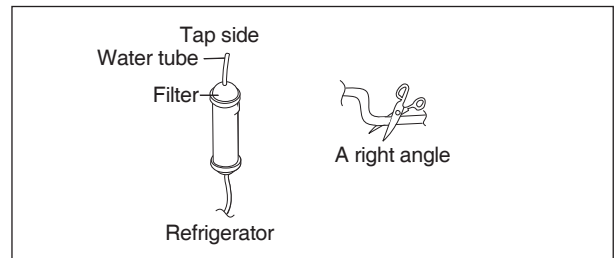

! Leave a sufficient distance when cutting the tubes.

3. Remove any substances in the filter.

- Open the main tap water valve and check if water comes out of the water tube.
- Check if the water valve is open in case water does not come out.
- Leave the valve open until clean water is coming out.
 - * Initial water may contain some substances out of filter (manufacturing process).

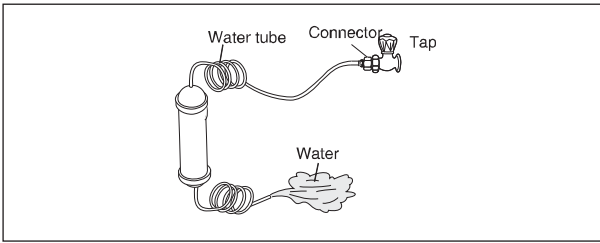

4. Attach the Filter Box

- 1) Screw and fasten the filter holder to the left/right side of the back of refrigerator.
* In case the holder is not fastened well, remove the back paper of the tape on the filter holder and attach it.
- 2) Insert the filter box into the holder.

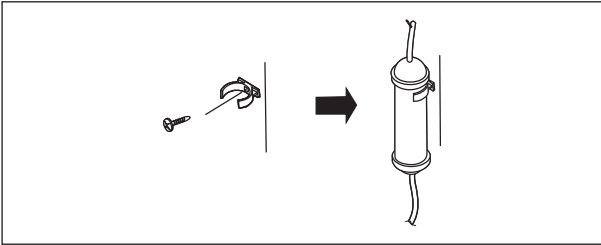

5. Connect the Water Tube to the refrigerator.

- 1) Remove the rear cover at the bottom back of the refrigerator.
- 2) Insert the fastening ring into the Water tube. (Be careful to follow the direction of the nut.)
- 3) Insert the Water Tube into the top of the water valve, turn the nut clockwise to fasten it. (The water valve is to the right of the motors.)
- 4) Check for any bent tubes or water leaks; if so, recheck installation procedure.
- 5) Replace the rear cover. (The water tube should be placed between the groove of the refrigerator back and motor cover.)

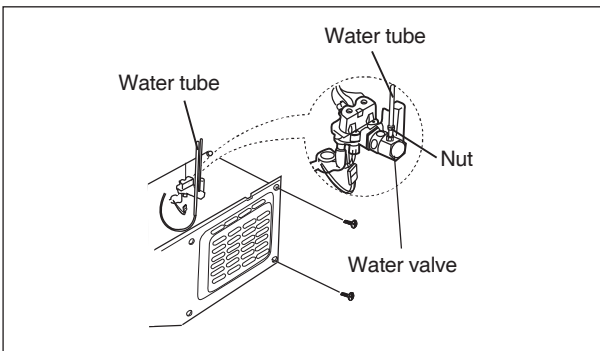

Set the tube upright as the figure shows.

6. Fasten the Water Tube.

- 1) Fasten the Water Tube with the [Fastener A] .
- 2) Check if the tube is bent or squeezed. If so, set it right to prevent any water leak.

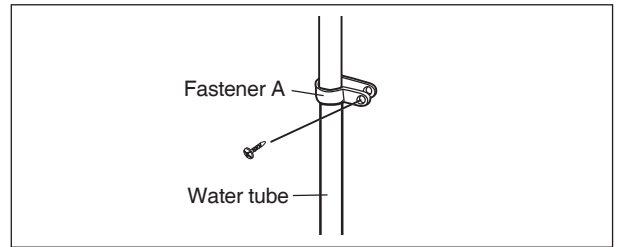

7. After installation of Water Supply System

- 1) Plug in the refrigerator, press the [WATER] button on the control panel for 2~3 minutes to remove any air (bubble) in the pipes and drain out the initial water.
- 2) Check for the water leaks again through the water supply system (tubes, connectors and pipes)
Rearrange the tubes again and do not move the refrigerator.

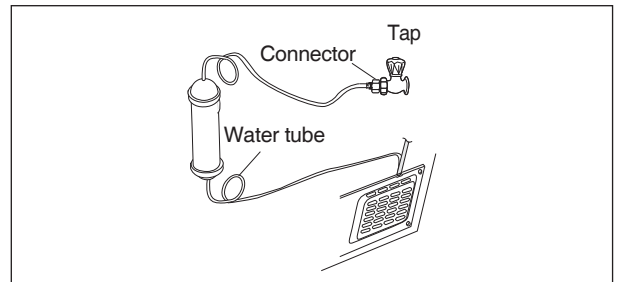

Information concerning the water filter

- After use, the water system is subject to low pressure. Proceed with caution when removing the filter.
- Flush the water system if the appliance has not been in use for a long period of time, or if the ice/water has an unpleasant taste or smell. To do this, dispense water through the water dispenser for several minutes. If the unpleasant taste or smell remains, replace the filter.
- Protect from frost: remove the filter cartridge if you expect the temperature to drop below freezing.
- If pressure surges could occur in the water pipe, do not install the water filter without a suitable surge eliminator. Contact an installation expert if you are not sure whether pressure surges could occur in the water pipe.
- After installing a new filter:
Discard any ice produced in the first 24 hours after switching on.
- If no ice has been removed for a long period of time, empty the ice box and discard any ice produced over the next 24 hours.

Control Panel

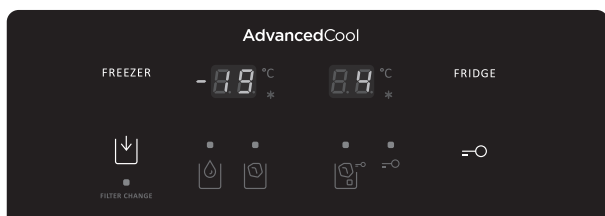

FREEZER

FREEZER

Temperature selection button for freezer compartment



DISPENSER/FILTER button

- 1) Button for dispenser function.
You can select WATER, CUBED ICE or ICE LOCK.
- 2) Button for filter exchange or reset.
After exchanging or to reset, press the button for 3 seconds.

FRIDGE

FRIDGE

Temperature selection button for refrigerator compartment.



Lock button for control panel

Press button for more than 3 seconds to activate and prevent settings from being unintentionally changed.
To unlock, press for more than 3 seconds.
The display goes out.



Indicators for water/ice dispenser

A orange LED above the icon will light up to indicate your selection for dispenser.



You can choose 'water' → 'cubed ice' → 'ice lock' by pressing the 'DISPENSER' button.



Indicator for control panel LOCK.



Filter change display

After 6 months of first power input, the icon will flicker.



- Interior lights of the refrigerator turn off when the doors are open for more than 10 minutes.
- In case either the freezer or refrigerator door is left open for more than a minute, door alarm rings for 5 minutes with 1 minute intervals.
- Display off function
 - All the light in the display will turn off after 20 seconds to save energy when doors closed.
 - The light will turn on when the door is opened or button is pressed.
 - Normal display mode resumes when customers operate buttons or doors.
- System off function (power off function)
 - You can stop operating the appliance without unplugging, especially on holidays.
 - Pressing FRZ.SET and REF.SET button at the same time for 5 seconds will turn the appliance off.
 - Under the 'off' mode, freezer and refrigerator temperature displays "-- --".
 - Other LED lights go out and all the operation of your appliance halts.
 - Conversely, pressing FRZ.SET and REF.SET button together for 5 seconds will switch it back on.

Temperature Control

* When this refrigerator is first plugged in, the temperature mode is set to 19°C / 4°C.

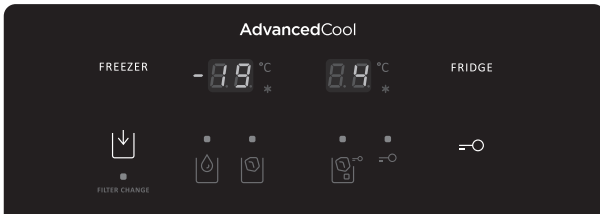

Freezer Compartment

Push the FRZ SET. button and the setting temperature changes as the figure shows.

>>> Sequential Temperature Change <<<



Faster Freezing...

When you want faster freezing, push the FRZ.SET button until LED '❄' turns on. Just push the button again to release.

Refrigerator Compartment

Push the FRZ SET. button and the setting temperature changes as the figure shows.

>>> Sequential Temperature Change <<<



Faster Cooling or Refrigeration

When you want faster cooling or refrigeration, push the REF.SET button until LED '❄' turns on. Just push the button again to release.



Caution

Foods in the refrigerator can be frozen if the ambient temperature of the refrigerator is below 5°C.

How to use the interior parts

■ Dispenser Models

NOTE: This guide covers several different models. The refrigerator you have purchased may have some or all of the items listed below. The locations of the features shown below may not match your model.

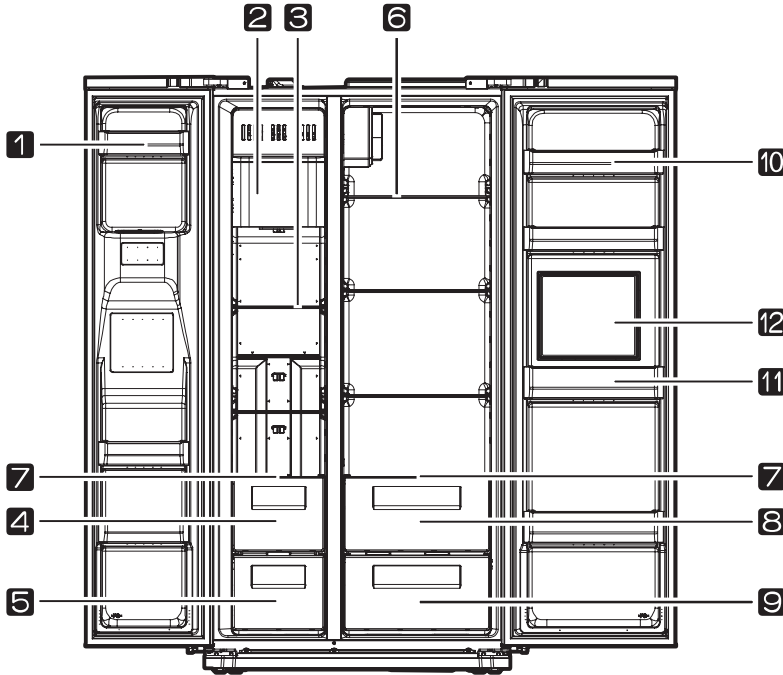

1. Freezer Pocket

For storing frozen foods (Do not store ice cream or long stored foods on the top freezer pocket.)

2. Ice maker & storage

3. Freezer Shelf (tempered glass)

For storing frozen foods such as meat, fish, icecream...

4. Meat case of Freezer

For storing meat, fish, chicken with foil cover or vinyl wrap

5. Drying Case of Freezer

For storing dried foods for so long (dried squid, dried anchovy etc.)

6. Refrigerator Shelf (tempered glass)

For storing common foods

7. Cover Case Shelf (tempered glass)

8. Vegetable Case

9. Fruit Case

For storing fruits

10. Refrigerator Pocket

For storing refrigerating foods, milk, juice, beer bottle etc.

11. Home bar Pocket

For frequently used cans, drink water, beverages

12. Home bar (Not all models)

Caution

- Do not store too much food in the appliance.
 - * When you open the door, an item may fall out and cause personal injury or material damage.
- Do not forget to prevent an undue rise in the temperature of frozen food while defrosting the appliance, such as wrapping the frozen food in several layer of newspaper.
- Do not remove the several part.
 - * It can be the risk of poor performance.

Food Storage Tips

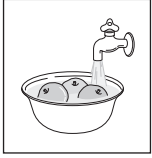

Wash foods before storing.

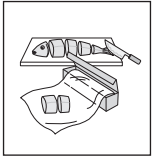

Divide and separate foods into smaller pieces.

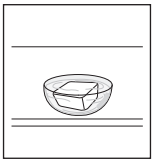

Place watery foods or foods with a lot of moisture in front shelves (close to door side).

If they are placed close to the cold air spout, they can be frozen.



Warm or hot foods should be cooled down enough before storing to reduce power consumption and to enhance refrigeration performance.



Be careful in storing tropical fruits such as bananas, pineapples and tomatoes, as they can easily deteriorate in lower temperatures.



Keep enough space between foods. If too tight or too close, cold air circulation is hindered, resulting in poor refrigeration.

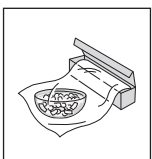

Never forget to cover or wrap foods to prevent odours.



Caution

- For further information about preparing food for freezing or food storage times, check a freezer guide or a reliable cookbook.

How to use the Dispenser (For Dispenser models)

* Select WATER / CUBED ICE
ICE(Optional) and press the cup on the PUSH pad for
your convenience.



Press the DISPENSER button() to select
WATER and ICON lights up to show it is on.



Press the DISPENSER button() to select
CUBED ICE and ICON turns on.

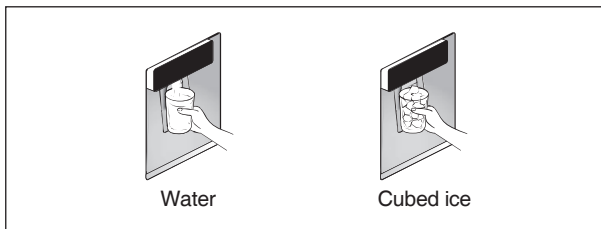

When cleaning the icecubes case assembly or if
you will not use it for a long time, remove the
icecubes in the ice storage case and lock the
icemaker by pushing the 'DISPENSER' button.

* When you get [CUBED ICE] release the cup from the
pad when it is half full.
(If you don't, the remaining ICES will make the cup
overflow or the dispenser outlet become blocked.)



Caution

- Avoid using thin fragile cups or crystal glasses when
taking icecubes.
- For your safety, never insert your fingers or other tools
into the dispenser outlet.
- If you find the icecubes are discolored, stop using the
dispenser and call a service agent.

How to use the Automatic Icemaker (For Dispenser models)

- About 7 icecubes (19~20 times a day) are made at one
time. If the ice storage case is full, icemaking stops.
- It is normal for the icemaker to make banging sounds
when the icecubes are falling into the ice storage case.
- To prevent bad odours or smells, regularly clean the
icecubes storage case.
- If the amount of ice in the storage case is not sufficient,
the ice may not be dispensed. Wait a day or so to make
more ice.
- If the ice does not dispense easily, ensure the dispenser
outlet is not blocked.

In case the icemaker doesn't work

If the icecubes get stuck and not dispensed

- Pull out the ice storage case and separate any icecubes
that may have stuck together.
- Press reset button on bottom of ice maker.
- If the amount of water which is supplied to the icemaker
needs adjusting, call for a service agent.

In case of power failure

- The icecubes in the case may melt and flow to the room.
- If many hours of power failure is predicted, pull out the
case, remove the icecubes in it and replace it back when
power resumes.



Use only the ices out of this refrigerator.

How to adjust the automatic ice maker water supply

Please ensure that water supply is adjusted to make the appropriate sized ice (80~85% of ice tray)

* If the ice is too small or too large, ice-making and icetransferring malfunctions may occur.

Before adjusting water supply, proper water supply should be measured according to the water pressure of the house which the refrigerator is installed.

■ Proper water supply measurement and control methods

1. After the initial power on, press 'dispenser' button to change to the mode of 'WATER'

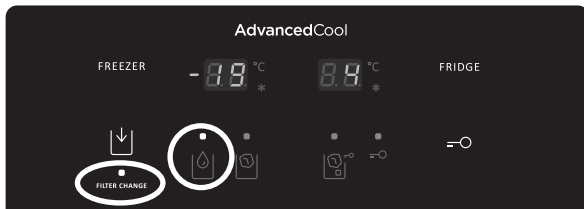

2. Press the water dispenser lever to receive more than 1 to 2 cups.

3. Press the LOCK button.

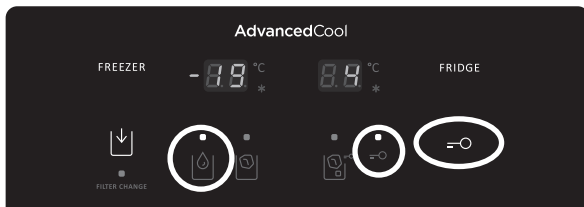

4. Change of water supply adjustment mode : Press the 'Dispenser' button for approximately 10 seconds

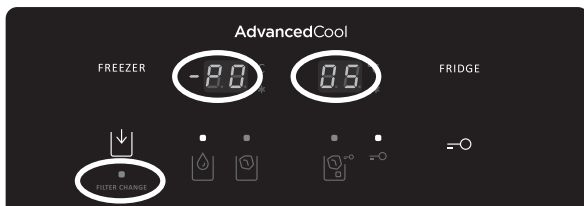

• The initial predetermined value of water supply is '5'

5. Push the dispenser lever and receive water until it stops.

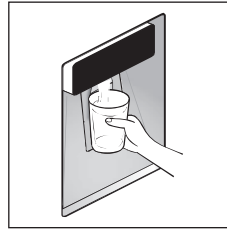

6. Pour the water received in a cup to the water supply measurement cover in order to determine the proper water supply compared to the water pressure.

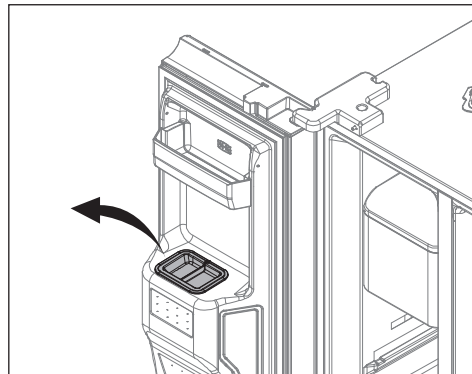

• If the water is filled as shown in the picture below, water supply is proper.
- Minimum proper water supply

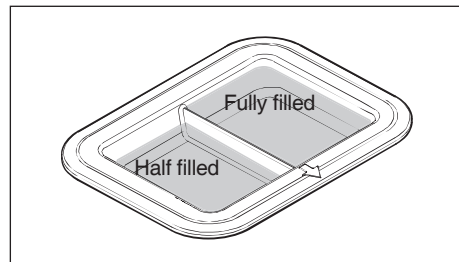

- Maximum proper water supply

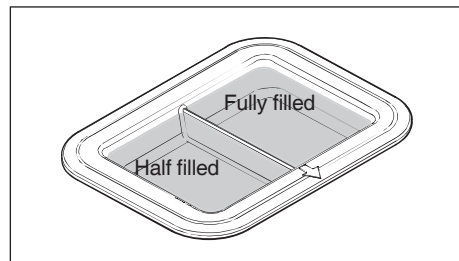

7. If the measured water supply is less or more than the proper water supply, take action as below.
- 7-1) If less than the minimum of proper water supply
Change the water supply set value to greater than '5' by pressing the dispenser button.

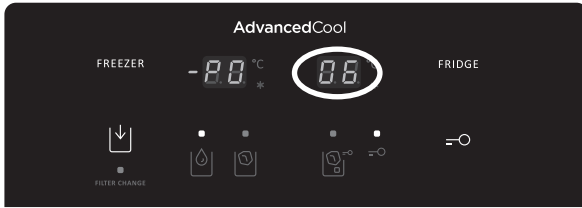

- 7-2) If less than the maximum of proper water supply
Change the water supply set value to lesser than '5' by pressing the dispenser button.

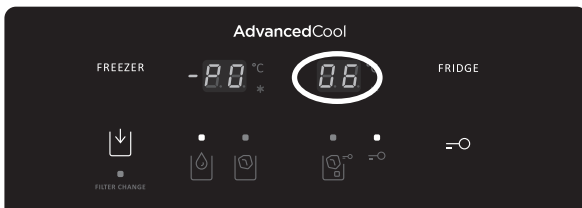

- 7-3) After change the water supply set value, determine the water supply over repeating items 5-6 above.
- The water supply set value is changed as follows depending on pressing 'dispenser' button once.

5 → 6 → 7 → 8 → 9 → 10 → 12 → 14 → 16 → 18 →
20 → 22 → 3 → 4

- The initial predetermined value of water supply is '5'

8. If the measured water supply is proper, hold the water supply adjustment mode by pressing 'Lock' button once.

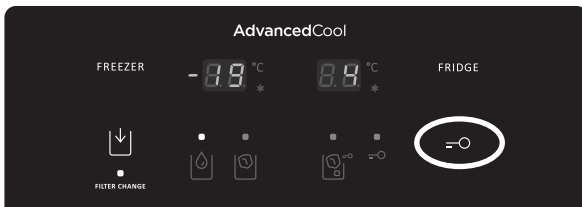

Refreshment compartment

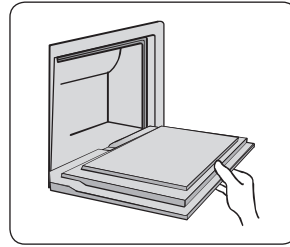

1. Softly press the upper centre of Home Bar to open (one-touch push type).
 - You can access the refreshment compartment without opening the door thus saving electricity.
 - The refrigerator lamp is lit when the refreshment compartment door is open. It is easy to identify the contents.

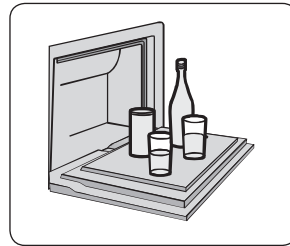

2. You can put your wine or food on the opened home bar cover.
 - Leaving the cover open for too long could weaken cooling performance.

Care & Cleaning

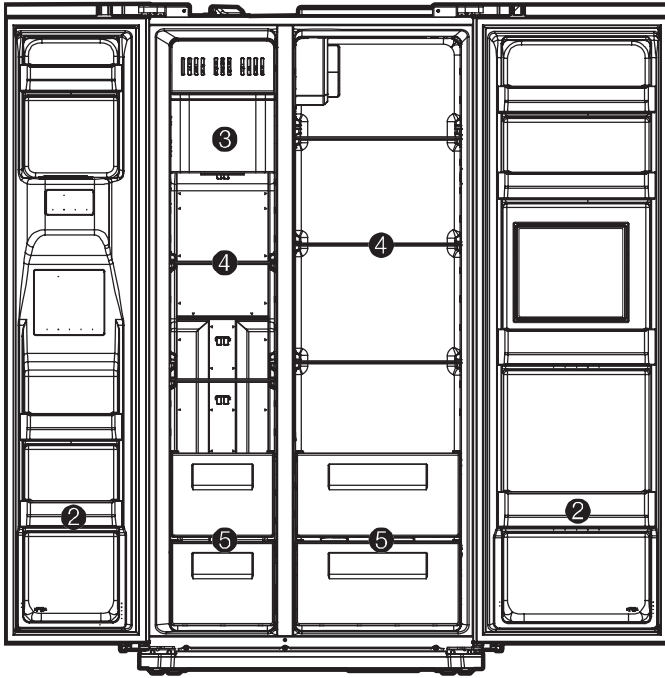

Be sure to unplug first !

* Full - option models illustrated.

❶ Dispenser Water Shelf

- Remove the water shelf and clean it. (The spill shelf is not self-draining.)

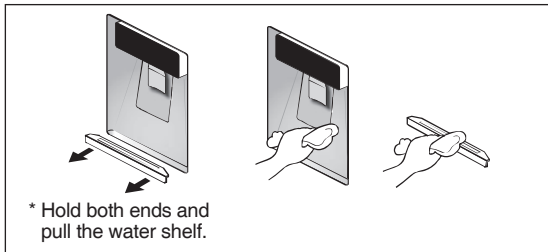

❷ Freezer & Refrigerator Pockets

- Hold both ends and pull up.

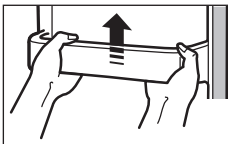

❸ Icecubes storage Case

- Removing: Pull the case assembly forward to remove.
 - Replacing: Fit to the side grooves and insert to the end. If it is difficult to fully insert the case, remove it, rotate the swirl coil in the case or drive mechanism a quarter turn and insert again.
- * Do not store the icecubes for too long.

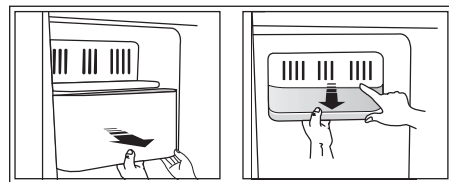

Never use any other electrical appliances together in the inside of the refrigerator for fear of electric shock or fire.

④ Freezer & Refrigerator Shelves

- Open the doors fully, then pull the shelves forward to remove.

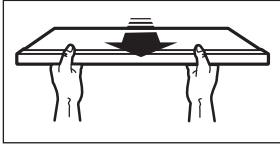

⑤ Vegetable Case & Fruit Case

- Pull forward and lift up a little to remove.

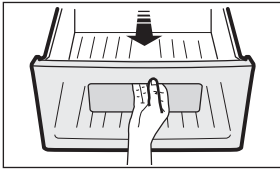

Caution

- For your safety, press the (ICE MAKER LOCK) once, when cleaning (removing & replacing) the icucubes storage assembly.
* Be careful not to hurt your hands and fingers when cleaning the assembly.

How to Clean

Interior Parts

- Use cloth with water and mild detergent to clean.

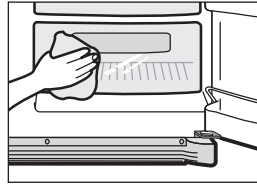

Door Packing

- Use cloth with mild (neutral) detergent.

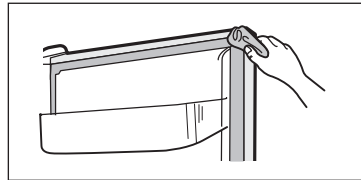

Back (Machine section)

- Remove dust on grill with a vacuum cleaner at least once a year.

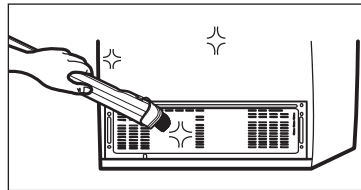

Caution

- Never use petrol, benzene, thinners, scouring pads or harsh abrasives, for they can damage the surfaces.



Before You Call for Service...

Please check the following troubleshooting tips before you call for service!

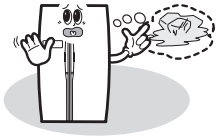

Problem

It never gets cold inside.
Freezing & refrigerating is not very good.

Checkup Point

- 1 Is the refrigerator unplugged?
- 2 Is the temperature set to [Low Mode]?
- 3 Is the refrigerator under direct sunlight or is a heat appliance placed near it?
- 4 Is the space between the refrigerator back and the wall too close?

Action

- 1 Plug in the refrigerator.
- 2 Set the temperature mode to Middle or High.
- 3 Move to a place where there is no direct sunlight, no heat appliances around.
- 4 Keep sufficient space between the back of the refrigerator and the wall.

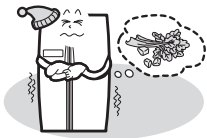

Problem

Foods in the refrigerator get frozen.

Checkup Point

- 1 Is temperature set to [High]?
- 2 Is the room temperature too low?
- 3 Is food with moisture stored close to the cold air spout?

Action

- 1 Set the temperature to [Middle] or [Low].
- 2 Foods can be frozen if ambient temperature is below 5°C. Move to a place where the temperature is over 5°C.
- 3 Place foods with moisture on the shelves close to the doors.

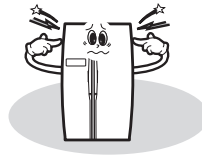

Problem

Strange sounds from the refrigerator.

Checkup Point

- 1 Is the floor beneath the refrigerator uneven?
- 2 Is the space between the refrigerator back and the wall too close?
- 3 Does any object touch the refrigerator?

Action

- 1 Move the refrigerator to a level and even floor.
- 2 Keep sufficient space.
- 3 Remove any object which touches the refrigerator.



Problem

Odour or unpleasant smell from the inside.





Checkup Point

- 1 Is the food stored uncovered or unwrapped?
- 2 Are the shelves and pockets stained with food stuff?
- 3 Is the food stored too long?

Action

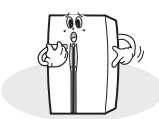
- 1 Be sure to cover and wrap the foods.
- 2 Clean them regularly. Once smell gets soaked into those parts, it is not easy to remove.
- 3 Do not store foods for too long. A refrigerator is neither a perfect nor a permanent food keeper.

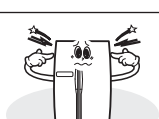
Something strange? Don't worry. Here is the answer.

	Case	Explanation
Heat	Front and side of refrigerator feels warm or hot. 	<ul style="list-style-type: none"> • Pipes (refrigerant vessel) are placed beneath the surface to prevent moisture forming on it.
Door is sticky	Doors do not open easily. 	<ul style="list-style-type: none"> • When you close the door and then open it again immediately, the door is not easy to open. Warm air rushes into the inside to create the pressure difference. In this case wait for a minute, it will then open easily.
Strange Sound	It sounds like water is flowing from the refrigerator. 	<ul style="list-style-type: none"> • When the compressor starts to run or stops, refrigerant which makes the inside cold flowing in the pipes can make such sound. • Defrosted water can also make such sound. (This refrigerator adopts an automatic defrosting system.)
	Cracking or clicking sounds. 	<ul style="list-style-type: none"> • Inside parts shrink and/or expand due to temperature change --- When the inside gets cold or when the door is open, such sounds can be made.
	Humming or buzzing sounds.	<ul style="list-style-type: none"> • Compressor or fans for cold air circulation can make such working sound. (If the refrigerator is not level, the sound can be louder.)
Frost & Dew	Dew or frost on the wall and/or food container surface in the freezer and refrigerator compartment. 	<p>Frost and/or dew can be made in the following cases;</p> <ul style="list-style-type: none"> • High temperature and/or high humidity around the refrigerator. • When doors are open too long. • Foods with much moisture are stored uncovered or unwrapped. <p>* You can see the same appearance when cold water is poured in a glass cup and dew is forming on the surface of it.</p>
	Dew on the cabinet surface.	<ul style="list-style-type: none"> • If it is highly humid around the refrigerator, moisture in the air sticks to the surface to form dew.