



Instructions for use



Refrigerator with freezer



Thank you for your confidence in buying our appliance and congratulations on the excellent choice. We hope it will successfully serve its purpose for many years.

The appliance is intended solely for household use.

Refrigerator with freezer is for domestic use only.

The lower part of the appliance is refrigerator and is used for storing fresh foods at the temperature of 0°C and higher.

The upper part is freezer and is used for freezing fresh foods and storing frozen foods for longer periods of time (up to one year, depending on the kind of foods you store). The compartment is marked with four stars.

Before first operation	3
A few tips on how to save power with your refrigerator-freezer combo	4
Description of the appliance	5
Installation and connection	8
Reverse door swing	10
Control panel - appliance with electronical regulation	11
Control panel - Appliance with mechanical regulation.....	13
Recommended distribution of food	15
Storing fresh food in the refrigerator	16
Freezing and storage of frozen food	18
Defrosting the appliance.....	20
Cleaning	21
Troubleshooting guide.....	22
Noise level.....	23

Before first operation

- This appliance can be used by children aged from 8 years and above and persons with reduced physical, sensory or mental capabilities or lack of experience and knowledge if they have been given supervision or instruction concerning use of the appliance in a safe way and understand the hazards involved. Children shall not play with the appliance. Cleaning and user maintenance shall not be made by children without supervision.
- Before connecting the appliance read these instructions carefully. They describe the appliance and provide instructions for its safe and correct use. The instructions are prepared for different types and models of the appliance so they may contain descriptions of functions and components your appliance may not have.
- Remove the wrapping protecting the appliance during transport. Door corners are fitted with protective spacers. Remove the spacers and replace them with the attached pegs.
- Before connecting the appliance to the mains supply, leave it in upright position for about 2 hours. This will reduce possibility of malfunctions in the cooling system resulting from prior transport and handling (certain models only).
- The appliance must be connected to the mains supply in accordance with the standing regulations and local requirements.
- The appliance must not be used in open air or exposed to weather precipitation.
- Always disconnect the appliance from power supply (pull the power cord from wall socket) before cleaning and before replacing the light bulb.
- If the power supply cord is damaged, in order to avoid hazard it must be replaced by the service or by qualified personnel.
- In case of longer disuse first turn the appliance off with the ON/OFF button and disconnect it from mains supply. Empty the appliance, clean the interior and leave the door ajar.
- For the protection of environment deliver the obsolete appliance to the authorized scrap appliance dealers.
- Wrappings contain environmentally friendly materials which can be recycled, recovered or disposed without threat to the environment.
- To prevent any pollution be careful not to damage the insulation or refrigeration tubes at the rear wall during the installation, cleaning and disposal of the appliance.
- Never let the children play with the appliance.
- Self closing door hinge (certain models only) pulls the door to the cabinet just before closing, thereby preventing the door to remain ajar. Equally it limits the door opening angle and prevents damage to adjacent elements.
- Practical longitudinal aluminum handle (certain models only) offers convenient grip anywhere along its length (convenient for children). It may also be decorated with a variety of design inserts (wood, inox,...).
- Odor filter (certain models only) removes foul and unpleasant smells from inside the cabinet and prevents their absorption by other food stored in the refrigerator. First remove the protective foil from the filter, then remove the aluminum gel protection at the back, and finally slip the filter onto the support from above, as shown on the sketch. After approximately 3 months the gel inside the filter is used up and the filter needs replacement. It can be purchased from the authorized Gorenje service centers.
- Rating plate with basic information is located in the interior of the appliance. If the sticker plate is not suitable for your language, replace it with the attached one.

- **WARNING!** Ventilation openings on the appliance or built-in cupboard must be kept clean and unobstructed at all times.
- **WARNING!** Do not use any mechanical accessories or other methods to defrost the appliance, except for those expressly recommended by the manufacturer.
- **WARNING!** During installation, cleaning, and removal of appliance, be careful not to damage the insulation of the parts of the cooling system. This will also prevent pollution.
- **WARNING!** Do not use any electric devices inside the appliance, except for those allowed by the manufacturer of this refrigeration appliance.



The symbol on the product or on its packaging indicates that this product may not be treated as household waste. Instead it shall be handed over to the applicable collection point for the recycling of electrical and electronic equipment. By ensuring this product is disposed of correctly, you will help prevent potential negative consequences for the environment and human health, which could otherwise be caused by inappropriate waste handling of this product. For more detailed information about recycling of this product, please contact your local city office, your household waste disposal service or the shop where you purchased the product.

A few tips on how to save power with your refrigerator-freezer combo

- Observe the installation instructions.
- Do not open the appliance door more frequently than necessary.
- Occasionally check whether air can circulate freely behind the appliance.
- Condenser unit mounted on the appliance back wall must be kept clean at all times (see section “Cleaning the appliance”).
- If the seal is damaged or loose, replace it as soon as possible.
- Store your food in closed containers or other appropriate packaging.
- Before placing the food in the refrigerator, let it cool down to room temperature.
- Defrost your frozen food in the refrigerator compartment.
- Remove the freezer drawers and door as described in the instructions, in order to make use of the entire capacity.
- Defrost your conventional freezer when a frost layer approximately 3-5 millimetres thick has accumulated on the surfaces in the freezer compartment.
- Make sure the shelves are evenly distributed and that the food is arranged in a way that allows free circulation of air (heed the recommended food arrangement as described in the instructions).
- In appliances fitted with a fan, do not block the fan slots.

Description of the appliance

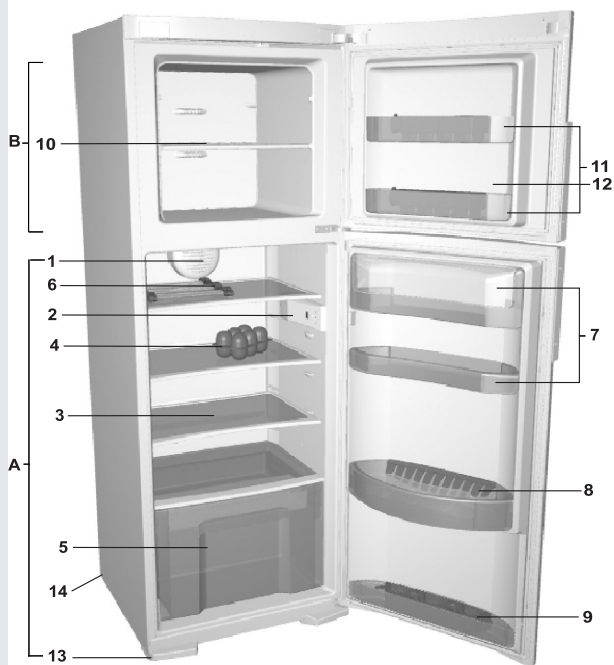

A Refrigerator

B Freezer

- 1 Fan*
- 2 Interior illumination
- 3 Fridge shelf (adjustable height)
- 4 Foldable egg tray (closed - 6 eggs, opened - 12 eggs)
- 5 Crisp pan
- 6 Bottle rack*
- 7 Door lining shelf (options: deep, shallow; lid or without lid)
- 8 Bottle carrier with safety holder*
- 9 Tube holder*
- 10 Freezer shelf (adjustable height)
- 11 Freezer door shelf
- 12 Ice tray
- 13 Leg
- 14 Wheel*

• Interior accessories of the appliance may vary according to the model.

* Certain models only.

A Refrigerator

B Freezer

- 1 Fan*
- 2 Interior illumination
- 3 Fridge shelf (adjustable height)
- 4 Pull-out guide shelf (max 12 kg)
- 5 Foldable egg tray (closed - 6 eggs, opened - 12 eggs)
- 6 Crisp pan
- 7 Bottle rack*
- 8 Fridge door shelf (max. 6 kg)
- 9 READY'N'SERVE removable tray with lid over deep shelf
- 10 Cheese tray
- 11 Twin row bottle carrier with safety holder*
- 12 Tube holder*
- 13 Freezer shelf (adjustable height)
- 14 Freezer door shelf
- 15 Ice tray
- 16 Leg
- 17 Wheel*

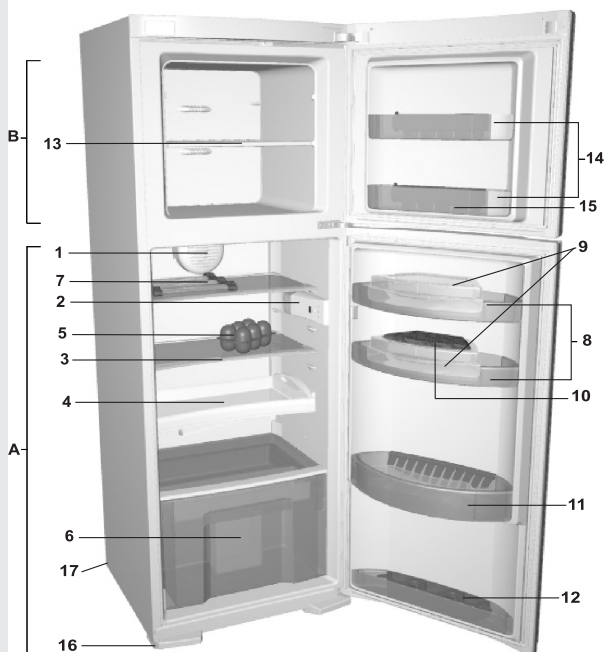

- Interior accessories of the appliance may vary according to the model.
- Crisp pan are extracted by lifting the rear end and pulling out inclined under the 45° angle. Reinsert in opposite sequence.
- * Certain models only.

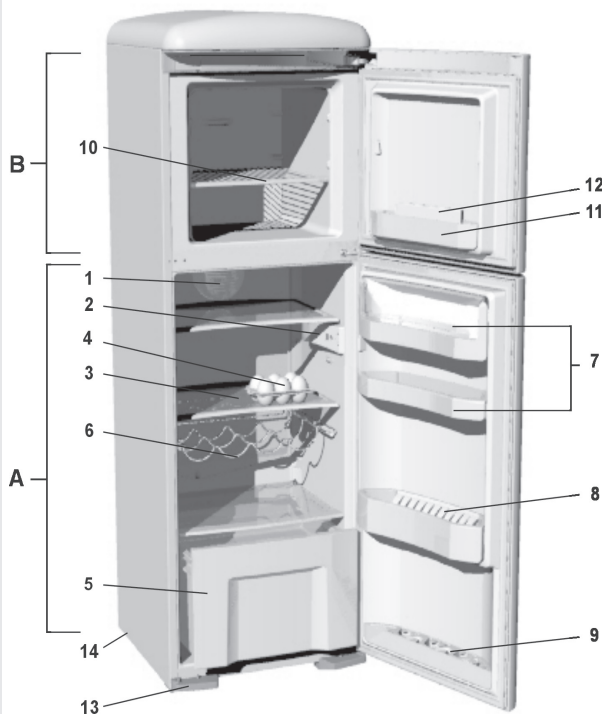

A Refrigerator

B Freezer

- 1 Fan*
- 2 Interior illumination
- 3 Fridge shelf (adjustable height)
- 4 Foldable egg tray (closed - 6 eggs, opened - 12 eggs)
- 5 Crisp pan
- 6 Bottle rack*
- 7 Door lining shelf (options: deep, shallow; lid or without lid)
- 8 Bottle carrier with safety holder*
- 9 Tube holder*
- 10 Freezer shelf (adjustable height)
- 11 Freezer door shelf
- 12 Ice tray
- 13 Leg
- 14 Wheel*

• Interior accessories of the appliance may vary according to the model.

* Certain models only.

Installation and connection

Selecting the location

- Place the appliance in dry and well aired room. The appliance operates best at temperature ranges indicated in the chart below. Relevant class of the appliance is indicated on the rating plate.

Class	Ambient temperature
SN (subnormal)	from +10°C to +32°C
N (normal)	from +16°C to +32°C
ST (subtropical)	from +16°C to +38°C
T (tropical)	from +16°C to +43°C

Positioning the appliance

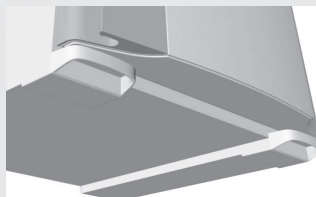
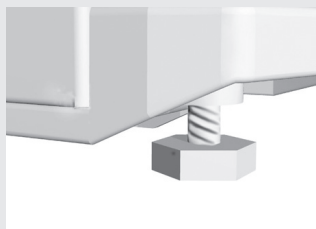

Positioning the appliance requires two persons in order to avoid injuries or damage to the appliance.

- Place the appliance flatly and firmly on a solid base. The appliance is fitted with adjustable feet on the front side, used to level the appliance. Rear side of the appliance is fitted with wheels facilitating the positioning of the appliance at the preselected place (certain models only).
- The element above the appliance must be at least 5 cm away to allow sufficient cooling of the condenser.
- Avoid exposing the appliance to direct sunlight or heat sources. If this is not feasible, install insulation plate between the appliance and adjacent heat source.
- Bottom front side of the appliance is fitted with handles to facilitate relocation. The appliance may stand independently or adjacent to a furniture element or wall. Be sure to leave enough space for the opening of the door, to avoid damage to the appliance or injuries to persons. Also leave ample space for extracting shelves (see installation diagram).

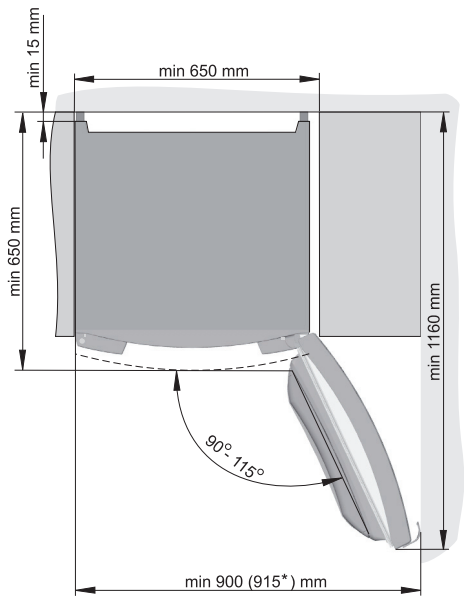
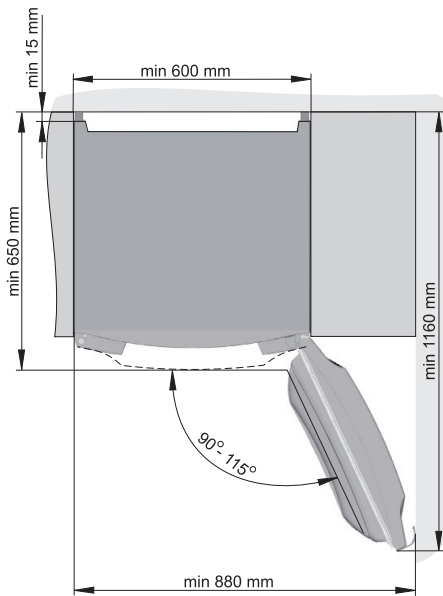

Connecting to power supply

Remark:

* Applies to RETRO appliances (in the model marking ...O...)

- Use the power cord to connect the appliance to the mains power. Wall outlet must be fitted with ground terminal (safety socket). Nominal voltage and frequency are indicated on the relevant label or rating plate of the appliance.
- Mains power connection and grounding must be made in line with standing regulations and local requirements.

The appliance is able to accommodate minor temporary voltage tolerances, but they may not exceed -6% to +6%.

Reverse door swing

Required tools: socket spanner nr. 8, screwdriver, torx 25.

Caution! After unscrewing of before fixing hinges, hold the door to prevent it from falling and damaging.

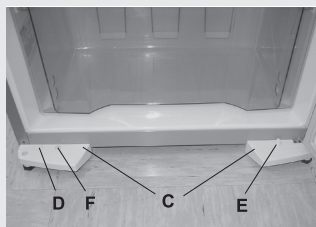
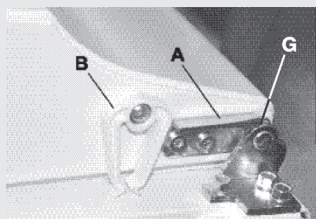

1. Remove upper hinge cover (save it for eventual later use), remove also the cover on the opposite side of the upper hinge cover (on the opposite side you will insert the attached cover during the assembly), and remove the cover on the opposite side of the upper part of the door.
2. Unscrew upper hinge screws and remove the upper door from the middle hinge.
3. On the bottom side of the upper door unscrew the swing stopper screws and remove the stopper (A). Keep this for eventual use later on. Fix the attached stopper with its bearing on the opposite side of the door.
4. Unscrew the forced door closure system (B) and fix it to the opposite side of the door (certain models only).
5. Unscrew middle hinge screws, remove the door from bottom hinge.
6. Unscrew leg holder fixing screws.
7. Tilt the appliance backward (max. 35°) to lean to the rear side of the cabinet. Unscrew the leg support screws (C) - left and right, and remove the leg support cover (D) and place it to the opposite side. Unscrew and remove, then reciprocally replace the position of end switch (E) and decorative peg (F) (for models with forced door closing system). Unscrew three screws fixing the bottom hinge (save the hinge for later use), and fix the attached bottom hinge on the opposite side.
8. Repeat the procedure 3 and 4 on the bottom door. In case there is no bottom door limit peg, transfer the bearing (G) and washer to the opposite side of the door.
9. Proceed with the assembly procedure in opposite sequence.

Note:

In appliances with the handle along the entire height of the door, the reverse door swing is not possible.

Remark:

At RETRO appliances (in the model marking ...O...) alteration of door opening direction is not possible.

Control panel - appliance with electronic regulation

CONTROL UNIT I

Model with keys

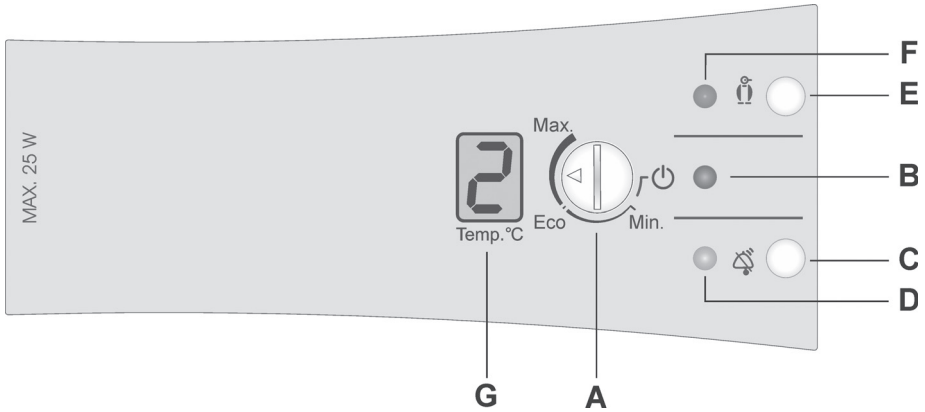

CONTROL UNIT II

Model without keys

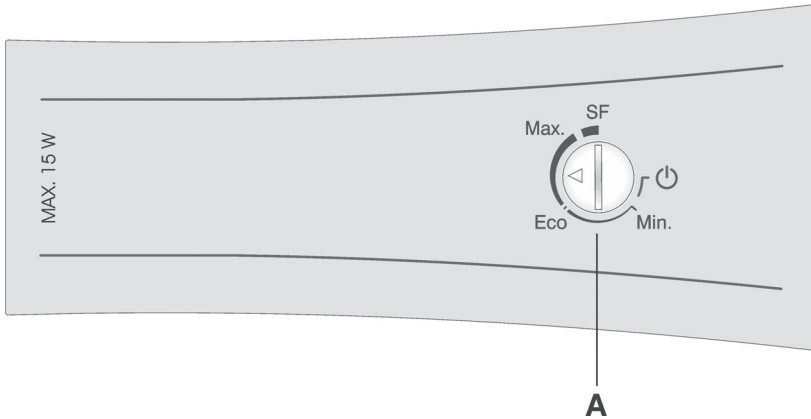

- A** Temperature selector and ON/OFF button
- B** Green LED: illuminated when the appliance is in operation*
- C** Freezer alarm off button*
- D** Red LED: flashing with freezer alarm*
- E** Fast freeze button*
- F** Orange LED: on during fast freezing procedure*
- G** The Digital temperature display indicates actual temperature inside the appliance from +1°C to +9°C.*

* Certain models only.

The ON/OFF button

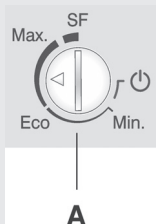
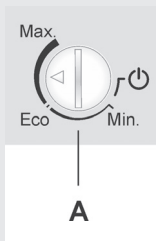

The appliance is switched on by turning the button **A** towards **Max.** Green LED is on. The appliance is switched off when the arrow on the button points to the ON/OFF mark  (the appliance, however, is still under mains power).

Setting freezer temperature

- Temperature of the appliance is set by turning the button **A** to the position between the **Min.** and **Max.**
- Recommended setting of the thermostat knob is to **Eco** position.
- If the room temperature, in which the appliance is installed, is lower than 16°C, the recommended setting of the thermostat knob is to the **Max.**

Rapid freeze function

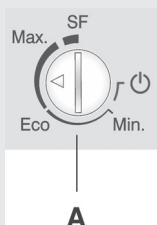
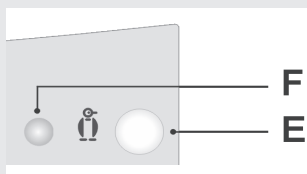

- Use this setting after switching on the appliance for the first time, and when inserting large quantities of unfrozen food (see “Freezing procedure”).
 - **models with keys:** press the **E** key (orange **LED F** will light up). The setting is automatically deactivated after approximately two days.
 - **models without keys:** rotate the **A** button to position **SF** (rapid freeze). After approximately two days, the rapid freeze function is switched off automatically and the appliance operates at the **Max** level. To repeat the rapid freeze procedure, rotate the **A** button to position **Eco**, and then back to **SF**.

Once the rapid freeze function is automatically deactivated, return the **A** button back to the desired position.

Freezer Alarm (certain models only)

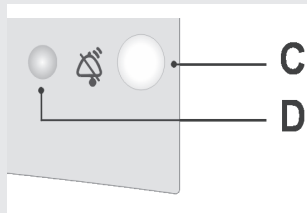

The sound alarm is activated if the freezer temperature rises above the allowed level (**intermittent tone**) and red lamp is flashing (**D**).

- The alarm can be turned off by pressing the Alarm Off button **C**, while the red light goes off automatically when the temperature inside the freezer reaches desired level and there is no danger for perishable goods.
- If the temperature in the freezer compartment fails to reach the required level even 24 hours after the alarm had been shut down, the alarm sounds again and shuts off automatically when the freezer compartment cools down to the required level and there is no danger for perishable food.
- After the first start, the appliance has a 24-hour default temperature alarm delay, since the freezer is not able to reach the required low temperature immediately. This is to prevent the alarm sounding.

Control panel - Appliance with mechanical regulation

ON/OFF button



The appliance is switched on/off by turning the temperature selector (see Fig.) to any position from 0 to 7.

The appliance operation is controlled by turning the thermostat (temperature selecting button) located within the refrigerator cabinet from the position STOP (0) to the position 7 and back.

Temperature setting

- The higher the position of the temperature selector (towards position 7) the lower is the temperature (cooler) within the cabinet of the appliance. Interior temperature in the refrigerator may even fall below 0°C. Higher position settings are to be used on in case of recommended low cooling temperature, or if the ambient temperature is below 16°C. If required, the  switch may also be activated. In case of standard ambient temperature we recommend the medium setting.
- Change in the ambient temperature affects the temperature of the appliance, so the position of the temperature selector should be adjusted accordingly.
- In the STOP (0) position the appliance is switched off (cooling system is off). However, the appliance is still powered (light bulb is turned on if you open the refrigerator door).

Fan

(only with some models)



- The fan contributes to more equal distribution of temperature and faster cooling, as well as reduces formation of dew on the shelves. It only operates when the compressor is activated.
- Turning on the fan is recommended as an additional function in the following cases:
 - increased temperature in the room (over 30°C),
 - increased humidity (during the summer),
 - when inserting larger quantities of food (rapid cooling).

• Turning the fan on / off

fan



ON

0

OFF

rapid cooling



ON

Note: When the fan is activated, power consumption is increased and temperature in the refrigerator drops.

Hence, we recommend resetting the temperature in the appliance:

- When the fan is activated: positions 1-4,
- When the fan is deactivated: positions 4-7.

Temperature setting for the refrigerator also affects the temperature in the freezer compartment.

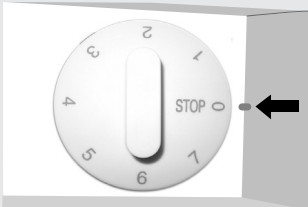

Recommended distribution of food

Recommended distribution of food

Refrigerator compartments:

- **top section:** canned food, bread, wine, cake, ...
- **middle section:** dairy products, cheese, readymade food, desserts, juices, beer, TV-dinners, ...
- **bottom section:** meat, meat products, delicatessen, ...
- **crisp pan:** fresh fruit, vegetables, salads, root vegetables, potatoes, onions, garlic, tomatoes, tropical fruit, sauerkraut, turnips, ...

Refrigerator door lining compartments:

- **top/middle section:** eggs, butter, cheese, ...
- **bottom section:** beverages, cans, bottles, ...









Freezer door lining compartments:

- **upper shelf position:** freezing
- **lower shelf position:** storage
- **door lining:** packed vegetables, ice-creams, ice,...



Storing fresh food in the refrigerator

Important precautions for storing fresh food

-  Proper use of the appliance, adequately packed food, correct temperature and hygienic precautions produce substantial impact on the quality of stored food.
-  Always respect the best before date, printed on the packaging.
-  Food to be stored in the refrigerator should be properly packed as to prevent emission and/or reception of moisture and odors.
-  Never store inflammable, volatile or explosive substances.
-  Beverages with high alcohol percentage shall be stored in tightly sealed bottles in vertical position.
-  Some organic solutions like volatile oils in lemon or orange peel, acids in butter etc. can cause damage in prolonged contact with plastic surfaces or gaskets for longer period of time they can cause accelerated aging of the plastic material.
-  Unpleasant odor inside the refrigerator is a sign that something is wrong with food or that your refrigerator needs cleaning (see chapter Cleaning).
-  If you plan a longer absence, make sure you removed quickly perishable articles of food from the appliance before you leave.

Interior accessories and space distribution

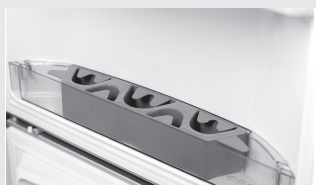
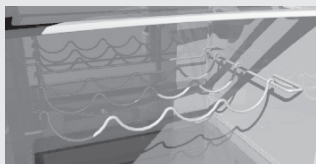
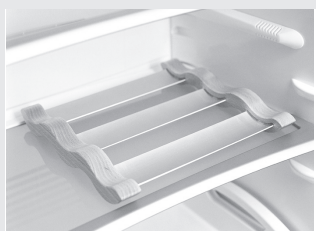

Equipment depends on the model.

- Shelves can be optionally placed on the guides inside the appliance. They are protected against pulling out. To remove the shelf, slightly lift up the back part and pull it out. Quickly perishable food should be stored on the back i.e. the coldest part of the shelves.
- Special pull-out drawer (certain models only) is installed onto the guide at the most convenient location in the refrigerator, to allow extraction from the appliance on a shelf and transfer to the table (used as a serving tray).
- Bottle carrier (certain models only) offers a choice of location. It can carry different bottles and/or cans, and it may also be used as a table bottle support. You can use it for storage of various bottles or tins, and it can also be used as a table plate. Certain models are equipped with wire bottle rack which enables placing of bottles on the cork. It is safeguarded against pulling out. It may be pulled out only if empty, by lifting the front part and pulling it towards you. Place the bottle rack in the appliance in such way to avoid obstruction of door closing by the length of the stacked bottles. Maximum load of the rack is 9 bottles of 0,75 l, or 13 kg of total mass - see label at the right side of the interior of the appliance.
- Crisp tray below the glass shelf at the bottom of the refrigerator is used for storage of fruit and vegetables. With some models, the compartment is mounted on telescopic runners/rails with one or two separate compartments (depending on the model); this enables separating various types of food and adjusting the compartments to your own requirements and habits.
- Interior of the door is fitted with trays and shelves for storage of cheese, butter, eggs, yoghurt and other small packages, cans, jars, etc. Bottom part of the door is fitted with the bottle rack and further below is the tube holder for convenient storage of tubes without overturning.
- Portable trays (certain models only) with lids are placed on deep trays. They are used for storage of small size food, used for breakfast and/or other snacks. You may also store food separated by the sweet, salty, sour, etc. principle. One of the lids carries the wooden cheese board.
- Two-row tray (certain models only) in the refrigerator door inner liner for frequently used food offer you much better use of space in the door inner liner. Food should be sorted in two rows according to the principle - high at the back and low in the front.
- Fan (located under the ceiling) provides better distribution of temperature and reduces dew on storage surfaces.

Approximate storage time of fresh foods

Food	Period
eggs, marinades, smoked meat,	up to 10 days
cheese	up to 10 days
carrots, etc...	up to 8 days
butter	up to 7 days
cake, fruit, TV-dinner dishes, raw chunks of meat	up to 2 days
fish, raw minced meat, seafood	up to 1 day

Freezing and storage of frozen food

Freezer interior accessories







- The freezer interior door lining is also fitted with various shelves and holders used for storing frequently used frozen food - quick access (ice-cream, open packages of vegetables, etc.)

Freezing procedure



- Activate intensive freezing 24 hours prior freezing fresh food.
Freezing procedure:
 - **control units I and II:** press the **E** key or rotate the **A** button to the SF position;
 - 24 hours before freezing fresh food, rotate the **A** knob to position between **4** and **6**. Tip the switch to , except in case of appliances of the A+++ energy class..
Do not let the already frozen packages touch the fresh ones.
- After 24 hours you can transfer food **into the bottom section of the freezer** and repeat freezing procedure if necessary.
- For freezing smaller quantities of fresh food (1-2 kg), the engagement of the fast freeze function is not required.

Important precautions for freezing of fresh food

-  **Freeze only such food which is suitable for freezing and sustain low temperatures. Food should be of adequate quality and fresh.**
-  **Select adequate packaging for each kind of food and pack it correctly.**
-  **The packaging should be air tight and well sealed without leaking since this could cause substantial vitamin loss and dehydration.**
-  **Mark packages with following data: kind and amount of foods and the date of loading.**
-  **It is imperative that food is frozen as quickly as possible. We therefore recommend the size of the package not to be too large and to be cooled before loading into the freezer.**
-  **The amount of the fresh foods that can be loaded in the freezer as a single load is declared on the rating plate. If the loaded amount is too large, the quality of freezing is reduced which in turn affects the quality of frozen foods.**

Storing commercially frozen food

The storage time and recommended temperature for storing commercially frozen foods is indicated on the packaging. Always follow manufacturer's instructions for storage and use of frozen food. When shopping be careful to choose only food which is adequately packed and provided with complete data and stored in freezers where the temperature never rises above -18°C. Do not buy packages of food wrapped with frost. This indicates that the package was thawed before at least once. Take care that packages don't start to thaw during transport to your home. Temperature rise shortens the storage time and affects the quality of commercially frozen foods.

Approximate storage time of frozen foods

Food	Period
ruit, beef	from 10 to 12 months
Vegetables, veal, poultry	from 8 to 10 months
Venison	from 6 to 8 months
Pork	from 4 to 6 months
Chopped (minced) meat	4 months
Bread, pastry, TV-dinner, fat free fish	3 months
Intestines	2 months
Smoked sausages, fat fish	1 month

Defrosting frozen food

Partially thawed or defrosted foods should be used as soon as possible. Cold air preserves the food but it does not destroy microorganisms which rapidly activate themselves after defrosting and make foods perishable. Partial defrosting reduces the nutritional value of food, especially fruits, vegetables and readymade meals.

Making ice



Remove the cap from ice tray (certain models only) and fill it to the mark with cold water or some other liquid, suitable for freezing. Close it and place it on the door shelf. Ice tray can produce 8 cubes.

It is recommended to make ice on stock.

Ice cubes are discharged from the tray by turning the tray upside down and placing it under cold running water. Shake the tray, open the cover and pour the ice out.

Defrosting the appliance

Automatic defrosting of the refrigerator

Refrigerator needs no special defrosting procedure, because ice deposited at the inner back wall is defrosted automatically. Ice deposited on the inner back wall during the compressor operation is defrosted when the compressor stops operating, and condensed water drops are drained through the outlet in the inner back wall into the drain pan situated above the compressor where it evaporates.

In case of excessive ice deposits at the inner rear wall of the refrigerator (3-5 mm), switch the appliance off by pressing the ON/OFF button and defrost it manually.

Defrosting the freezer

- Clean the freezer when the frost layer in the freezer reaches thickness of around 3-5 mm.
- 24 hours prior defrosting fresh food activate intensive freezing knob to quickly freeze freshly inserted food. After that empty the freezer and take care that the packages remain frozen.
- Switch the appliance off by turning the temperature selector (A) to the mark .
- Leave the door open for so much time to be able to remove easily the accumulated frost and ice from surfaces. You can use plastic scraper, but be careful not to damage the interior surfaces of the freezer.

Wipe the frost and ice from the freezer before it has completely melted.

- Never use powered appliances to defrost the freezer (hair dryer, etc.).
- Avoid using defrosting sprays, as they may cause damage to the plastic parts and may be hazardous to health.
- Clean the interior of the appliance and wipe it dry (see chapter Cleaning).
- Before reloading food into the freezer switch the appliance on.

Cleaning

Prior any cleaning attempt disconnect the appliance from the mains (pull the power cord from the mains wall outlet). Special antibacterial protection in top layer of inner walls prevents multiplication of bacteria and maintains the interior clean and germ free.

Make sure to remove traces of any cleansing agents you had been using.

- To clean any surface, use a soft cloth.
- Clean the **exterior** of the appliance with water and liquid detergent.
- For cleaning of plastic, coated, or aluminum parts avoid using abrasive or special cleansing agents (like the stainless steel polish), otherwise you may damage the surface.
- Clean coated and aluminum surfaces using the soft cloth and alcohol based cleaning agent (like glass cleaner).
- Wash the **interior** of the appliance with liquid detergent and lukewarm water, mixed with a little vinegar.

Groove and drain outlet located below the cooling panel at the rear wall collect the drained water, so they must not be clogged (with food particles, for example). Make sure you inspect them periodically and clean if necessary (use plastic straw to free the outlet hole).

- The **condenser** on the rear wall must always be clean and free of dust or kitchen fumes deposits, therefore clean the dust periodically with non-metallic brush or vacuum cleaner.
- Clean also the **drip pan** above the compressor. Ice and/or frost deposits exceeding 3-5 mm increase energy consumption, so you need to remove them regularly. Do not use sharp pointed objects, solvents or sprays.
- After cleaning switch the appliance on and reload the food.

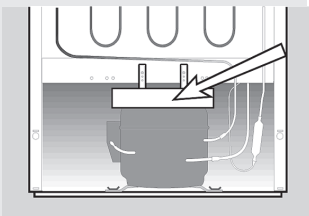
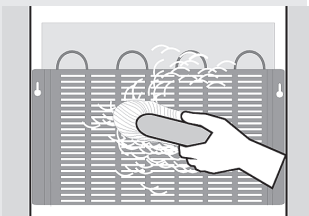

Troubleshooting guide

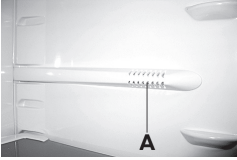
Fault:	Cause/Remedy
The appliance does not operate after connection to the mains:	<ul style="list-style-type: none"> • Check if there is power in the socket and if the appliance is switched on.
Cooling system operates continuously without intermittent stoppages:	<ul style="list-style-type: none"> • Ambient temperature too high. • Frequent opening of the door, door open too long. • Door not closed properly (particle between door gasket, sagged door, check gasket sealing, etc...). • Excessive quantity of fresh food inserted at once. • Check air circulation for sufficient cooling of the compressor, and clean the condenser. • Intensive freezing' or 'Intensive cooling' option is on.
Excessive ice formation at the rear interior wall of the refrigerator:	<ul style="list-style-type: none"> • Frequent opening of the door, door open too long. • Inserting hot food in the refrigerator. • Food or dish is touching the rear interior panel of the refrigerator. • Bad door sealing; clean or replace the gasket if dirty or damaged.
Water dripping from the appliance:	<ul style="list-style-type: none"> • Drain outlet is clogged, drain water drips past the collection groove. • Clean the clogged outlet using plastic straw. • Thaw thick ice deposits manually (see chapter Defrosting).
Interrupted or continuous sound alarm (refrigerator/freezer): 	<ul style="list-style-type: none"> • Frequent opening of the door, door open too long. • Door not closed properly (particle between door gasket, sagged door, damaged gasket, etc...). • Excessively long power failure. • Excessive quantity of fresh food inserted at once. • Refrigerator sensor (A) is crammed with fresh food. Free the sensor and allow air to circulate around it.
Difficult door opening:	<ul style="list-style-type: none"> • If you attempt to open the immediately closed door of the freezer you may experience resistance. This happens because certain quantity of cold air escapes from the appliance through the open door and is replaced by warm ambient air. Cooling of such air creates negative pressure (vacuum) and suction, which prevents easy opening of the door. Situation is normalized after a few minutes, and you can open the door with ease.

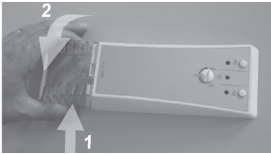
Fault:	Cause/Remedy
Bulb replacement: 	<ul style="list-style-type: none"> • Before replacing the light bulb, disconnect the appliance from the power supply. Remove the plastic cover, replace the bulb with a new one (E14, same voltage as the factory one) and fit back the cover. • Don't forget: the old bulb does not belong to organic waste. • Light bulb is consumption material and is not covered by the warranty. • Bulb lamps used in this appliance are special purpose lamps selected for household appliances use only. They are not suitable for household room illumination.
Green LED is flashing:	<ul style="list-style-type: none"> • If the green LED is flashing, call the nearest service center.
Troubleshooting helpful hints:	<ul style="list-style-type: none"> • If you are not able to fix the trouble by any of the above tips, disconnect the power cord from the mains outlet, wait 10 minutes, and reconnect the appliance. In case trouble persists, contact the nearest authorized service center, giving them the type, model and serial number of the appliance, written on the rating plate in the inside of the appliance.

Noise level

The refrigerator - freezer appliances are cooled by the refrigeration system with a compressor, whose operation may produce certain noise. The level of such noise depends upon the location, correct use and age of the appliance.

- **After starting the appliance**, the operation of the compressor (the refrigerant flow) may be somewhat louder. This does not mean that something is wrong with the appliance, neither has it any influence on the lifetime of the appliance. Gradually the noise is reduced and eventually subsides.
- Sometimes the appliance produces **unusual and stronger noise** which is rather unusual for the appliance. This noise is often the consequence of inadequate positioning of the appliance:
 - The appliance should be placed and leveled firmly on solid base.
 - It should not touch the wall or adjacent kitchen units standing next to it.
 - Check whether the accessories in the interior of the appliance are placed correctly in their positions; also check the bottles, tins and other vessels that might touch each other and rattle.

THE MANUFACTURER RESERVES THE RIGHT TO ALTER THE SPECIFICATIONS WITH NO IMPACT TO THE FUNCTIONAL OPERATION OF THE APPLIANCE.

Instructions for use of the appliance can also be found on our website at www.gorenje.com / < <http://www.gorenje.com> / >

HZZS 3067 CLA EXC PRE + OT



149809

en (04-19)