

GB Instructions for use



Refrigerator-freezer

We thank you for the confidence you have shown by purchasing our appliance.
We wish you a lot of pleasure using the appliance.

The appliance is intended solely for household use.

The lower part is the refrigerator compartment intended for storing fresh food at temperatures above 0°C.

The upper part is the freezer compartment intended for freezing fresh food and long-term storage of frozen food (up to one year, depending on the type of food). This compartment is labeled with four stars / asterisks.

Important warnings	3
A few tips on how to save power with your refrigerator-freezer combo	4
Appliance description	5
Installation and connection	6
Changing the door opening direction	8
Appliance operation	10
Recommended food arrangement in the appliance	13
Storing food in the refrigerator	14
Freezing fresh food and storing frozen food	15
Defrosting the appliance.....	17
Cleaning the appliance	19
Troubleshooting	20
Information on appliance noise	21

Important warnings

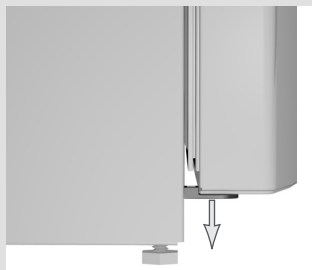

- This appliance can be used by children aged from 8 years and above and persons with reduced physical, sensory or mental capabilities or lack of experience and knowledge if they have been given supervision or instruction concerning use of the appliance in a safe way and understand the hazards involved. Children shall not play with the appliance. Cleaning and user maintenance shall not be made by children without supervision.
- Before connecting the appliance, carefully read the instructions for use which describe the appliance and its correct and safe use. The instructions apply to several types/ models; therefore, they may include descriptions of settings and equipment that may not be available in your refrigerator.
- Remove the packaging that is intended for protecting the appliance or its respective parts during transport.
- Spacers are fitted in the corners of the doors; these should be removed and the plugs attached (only with some models) should be inserted into the openings.
- Before connecting to the power mains, the appliance should be left to stand still in upright position for at least 2 hours. Thus, operation errors due to the effect of transport on the cooling system will be much less likely to occur.
- The appliance must be connected to the power mains and grounded in compliance with the effective standards and regulations.
- The appliance may not be used outdoors and should not be exposed to rain.
- The appliance must be disconnected from the power mains (unplug the power cord from the wall outlet) before cleaning or before replacing the bulb.
- If the power cord is damaged, it should be replaced by a service technician or other authorized person.
- If the appliance is not used for a longer period of time, switch it off with the relevant button and disconnect it from the power mains. Empty the appliance, defrost it, clean it, and leave the door ajar.
- To protect the environment, dispose of the appliance after its useful life by taking it to an authorized waste collection center.
- The packaging is made of environment-friendly materials that can be recycled, disposed of, or destroyed without hazard to the environment.
- Children should not play with the appliance.
- The label with basic information on the appliance is attached in the appliance interior. If the label is not in your local language, replace it with the one supplied with the appliance.

- **Warning!** Ventilation slots on the appliance or a built-in element must always be clean and unobstructed.
- **Warning!** Do not use mechanical devices or tools to defrost the refrigerator, nor any other methods except for those recommended by the manufacturer.
- **Warning!** When installing, cleaning, or removing the appliance, make sure the insulation on the refrigeration system parts is not damaged. Thus you will also prevent damage to the environment.
- **Warning!** Do not use electric appliances in the refrigerator or freezer interior, except for those expressly allowed by the refrigerator-freezer manufacturer.



The symbol on the product or on its packaging indicates that this product may not be treated as household waste. Instead it shall be handed over to the applicable collection point for the recycling of electrical and electronic equipment. By ensuring this product is disposed of correctly, you will help prevent potential negative consequences for the environment and human health, which could otherwise be caused by inappropriate waste handling of this product. For more detailed information about recycling of this product, please contact your local city office, your household waste disposal service or the shop where you purchased the product.

A few tips on how to save power with your refrigerator-freezer combo

- Observe the installation instructions.
- Do not open the appliance door more frequently than necessary.
- Occasionally check whether air can circulate freely behind the appliance.
- Condenser unit mounted on the appliance back wall must be kept clean at all times (see section "Cleaning the appliance").
- If the seal is damaged or loose, replace it as soon as possible.
- Store your food in closed containers or other appropriate packaging.
- Before placing the food in the refrigerator, let it cool down to room temperature.
- Defrost your frozen food in the refrigerator compartment.
- Remove the freezer drawers and door as described in the instructions, in order to make use of the entire capacity.
- Defrost your conventional freezer when a frost layer approximately 3-5 millimetres thick has accumulated on the surfaces in the freezer compartment.
- Make sure the shelves are evenly distributed and that the food is arranged in a way that allows free circulation of air (heed the recommended food arrangement as described in the instructions).
- In appliances fitted with a fan, do not block the fan slots.

Appliance description

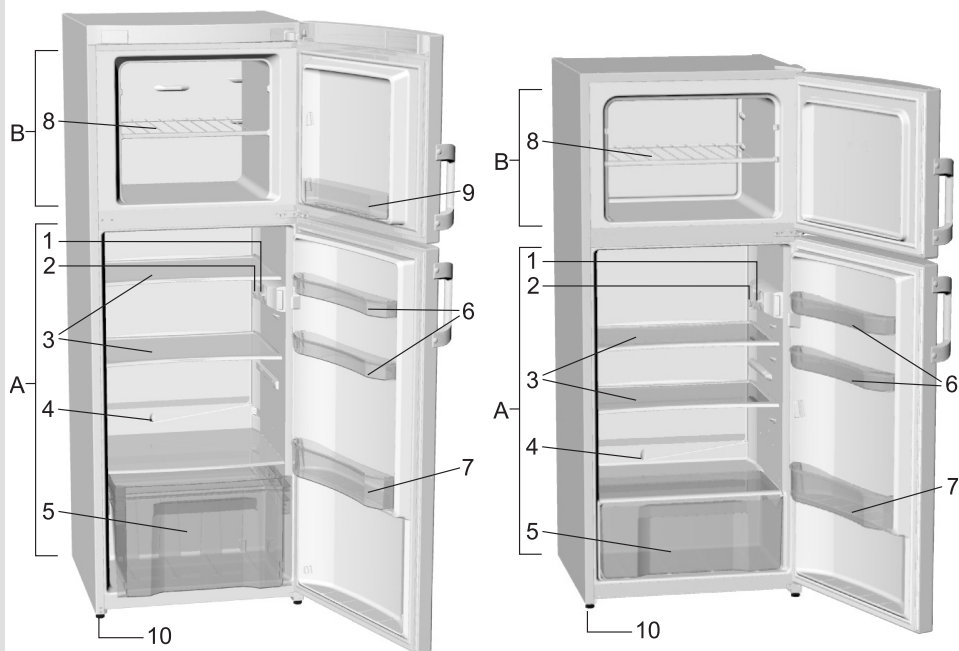

A Refrigerator compartment

B Freezer compartment

- 1 Control unit
- 2 Interior illumination lamp
- 3 Shelf (height adjustable)
- 4 Water discharge groove/gutter
- 5 Fruit and vegetables bin / drawer
- 6 Refrigerator door shelf (deep and shallow version)
- 7 Bottle shelf
- 8 Freezer shelf (height adjustable)
- 9 Freezer door shelf*
- 10 Foot

- Appliance interior equipment may change subject to appliance model.
- The drawers are protected against pulling out. If you wish to remove a drawer, pull it out as far as it will go, then lift its front part and pull it out completely.
- * Only with some models.

Installation and connection

Selecting the room

- The appliance should be installed in a dry and well ventilated room. The appliance will operate correctly if the environment temperature is within the ranges listed in the table below. The appliance class is indicated on the label with the basic information on the appliance.

Class	Temperature
SN (subnormal)	from +10°C to +32°C
N (normal)	from +16°C to +32°C
ST (subtropical)	from +16°C to +38°C
T (tropical)	from +16°C to +43°C

Installing the appliance

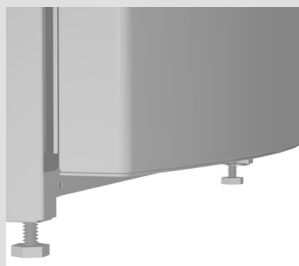

Appliance installation should be carried out by at least two persons to avoid any physical injury or damage to the appliance.

- The appliance should stand firmly in an upright position on a sufficiently solid base. At the front, the appliance is fitted with two adjustable legs that can be used to level the appliance.
- If there is a kitchen furniture element above the appliance, there should be a clearance of at least 5 centimeters between this element and the refrigerator, to ensure sufficient cooling of the condenser unit.
- Do not expose the appliance to direct sunlight and do not place it near sources of heat. If this cannot be avoided, install an insulation panel.
- The appliance may stand freely or it can be placed next to a kitchen furniture element or a wall. Mind the space required to open the door and pull out the drawers and shelves (see installation diagram).

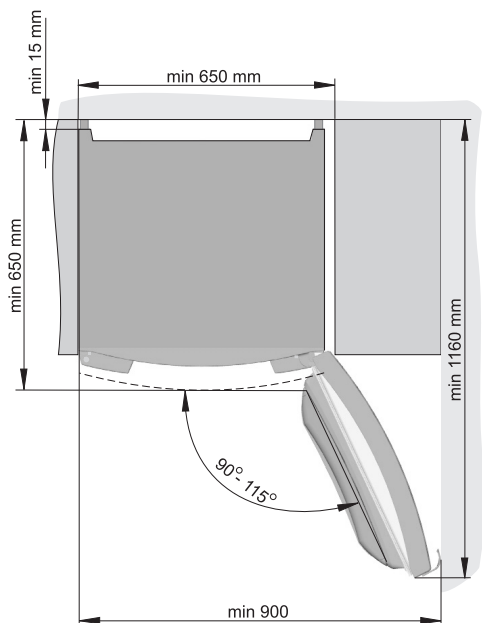

Connecting the appliance

- Use the power cord to connect the appliance to the power mains. The wall outlet should be fitted with a ground contact (safety socket). Nominal voltage and frequency are indicated on the label with basic information on the appliance.
- The appliance should be connected to the power mains and grounded in compliance with the relevant effective standards and regulations. The appliance will withstand short-term deviations from the nominal voltages, but not more than from -6 % to +6%.

Changing the door opening direction

Appliance: HZZS3067/ HZZS3067F

Tools required: ring spanner (box-end wrench) No. 8, screwdriver, torx25, flathead screwdriver

1. Use a flathead screwdriver to remove the hole plugs/covers A and B1.
 2. Unscrew and remove – one by one, in the specified order from top to bottom – the hinges (C, D, and E1) and the door (F, G). Make sure the door is not damaged.
 3. Move the hole plugs / covers (H) to the opposite side.
 4. Attach the lower hinge (E2, supplied in a bag) to the opposite side of the housing and add the washer (I).
 5. **Upper door (F):** Move the upper hinge (C) with the bearing (J) to the opposite side. Remove the door stopper with the hinge (K1) and attach a symmetrical door stopper (K2, supplied in a bag) to the opposite side.
 6. **Lower door (G):** move the hinges (L) and the cover (M) to the opposite side.
 7. Install / attach, from bottom up, the hinges (D, C) and doors (G, F). Do not forget to install the washers in the same way they were installed before disassembling (I).
 8. Install the covers A and B2 (cover B2 from the supplied bag).
 9. **Replacing the handle:** remove the hole plugs/covers, unscrew the screws and attach the handle to the opposite side. Insert the plugs into the holes on the opposite side.
- Save the elements B1, E1, and K1 in case you need them to change the door opening direction again at a later time.

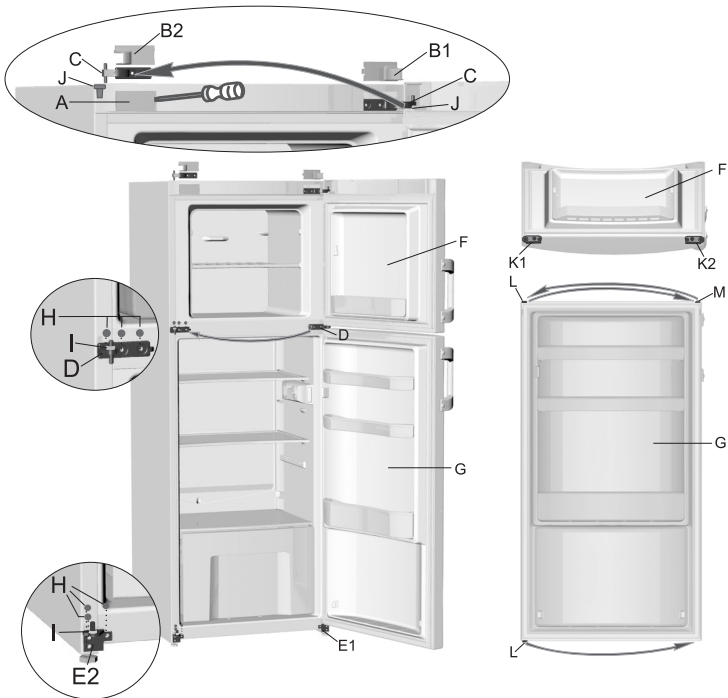

Appliance: HZS2767 / HZS2767F

Tools required: socket wrench / spanner Nr. 8, slot and cross screwdriver

1. Use the slot screwdriver to remove the covers A and B.
2. Undo / remove the hinges (C, D, E1) and the door (F, G), starting from the top and working your way down. Make sure the door is not damaged.
3. Move the covers (H) to the opposite side.
4. **Upper compartment door (F):** move the hinges (J) and the cover (M) to the opposite side.
5. **Lower compartment door (G):** move the hinges (L) and the cover (M) to the opposite side.
6. Start from the bottom and work your way up: attach and secure the lower hinge (E2) supplied in a bag; mount the door (G); fasten the hinge (D); mount the door (F); and fasten the hinge (C). Do not forget to use the washers, placing them as they were before the door was removed.
7. Attach the covers A and B.
8. **Changing the handle position:** remove the covers, undo the screws, and attach the handle to the opposite side. Place the covers on the opposite side. Use the covers supplied in a bag to cover the slot where the handle was initially attached.

Save the hinge E1 in case you need to change the direction of door opening again at a later time.

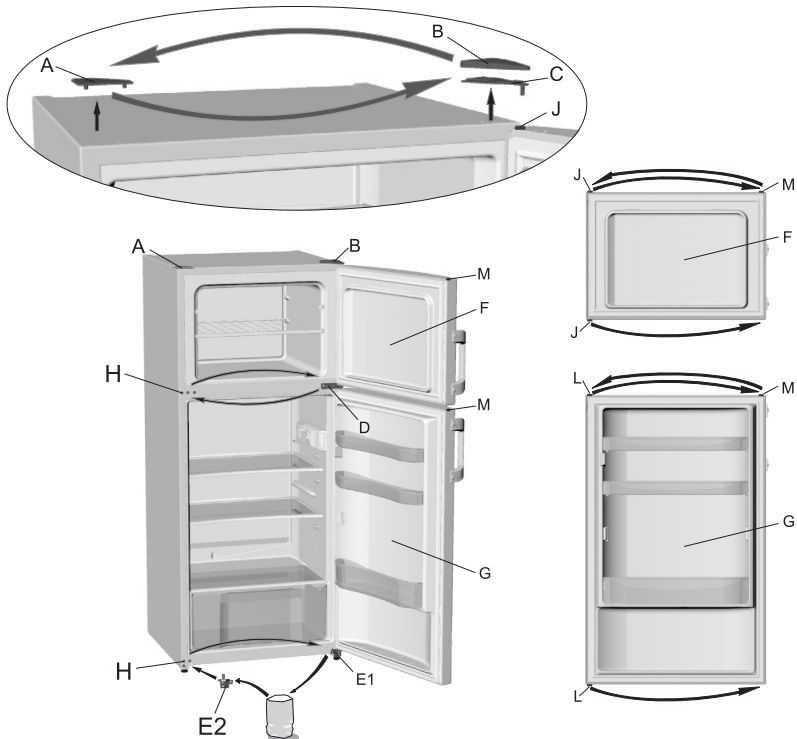

Appliance operation

CONTROL UNIT I

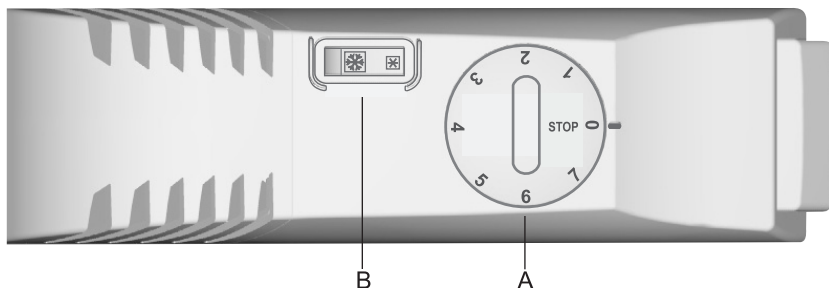

A Temperature setting and on/off knob

B Super Freeze switch

Turning the appliance on/off

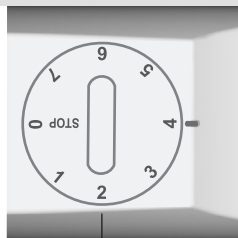

A

Turn on: rotate the thermostat knob clockwise towards position 7.

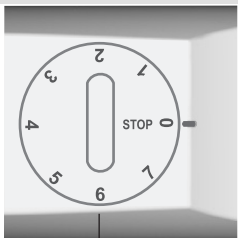

A

Turn off: rotate the knob back to position **STOP (0)**.

Setting the temperature

- Higher settings (towards 7) selected with the knob correspond to lower (cooler) temperatures. The temperature in the refrigerator interior may drop below 0°C. Only use higher settings when a lower temperature is desired and recommended or when environment temperature is lower than 16°C. If required, the ❄️ switch may also be activated. When the environment temperature is normal, a medium setting is recommended.
- A change in the environment temperature affects the temperature in the appliance. Hence, the thermostat setting should be adjusted accordingly.
- When the thermostat knob is set to position STOP (0), the appliance will not operate (cooling system is off); however, the appliance is still powered (a light will illuminate the interior when the refrigerator door is opened).

CONTROL UNIT II

Model without fan

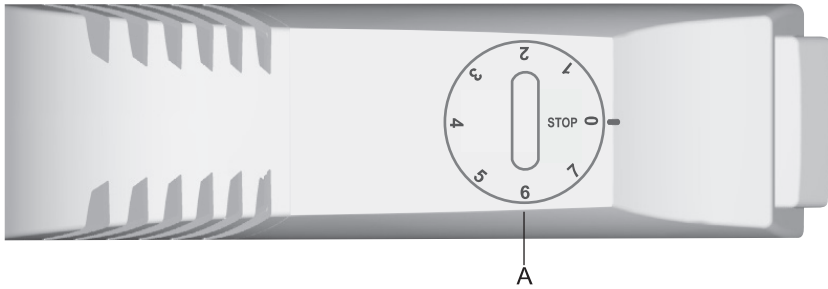

Model with fan

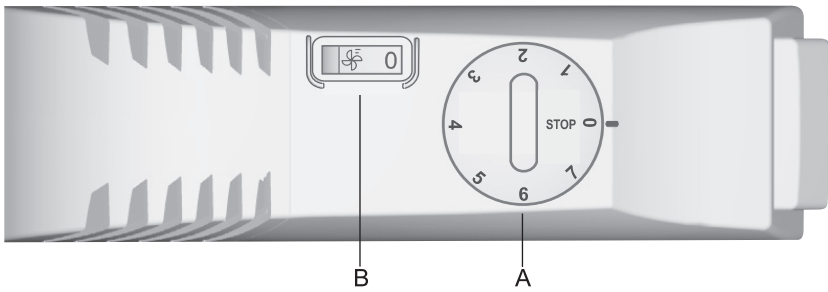

A Temperature setting and on/off knob

B Fan on/off switch (only with some models)

Turning the appliance on/off

Turn on: rotate the thermostat knob clockwise towards position 7.

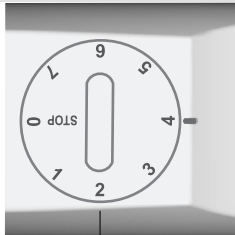

A

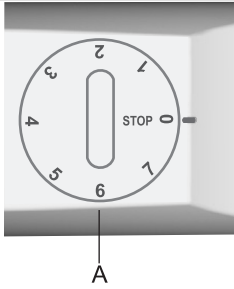

Turn off: rotate the knob back to position **STOP (0)**

Setting the temperature

- Higher settings (towards 7) selected with the knob correspond to lower (cooler) temperatures. The temperature in the refrigerator interior may drop below 0°C. Only use higher settings when a lower temperature is desired and recommended or when environment temperature is lower than 16°C. When the environment temperature is normal, a medium setting is recommended.
- A change in the environment temperature affects the temperature in the appliance. Hence, the thermostat setting should be adjusted accordingly.
- When the thermostat knob is set to position STOP (0), the appliance will not operate (cooling system is off); however, the appliance is still powered (a light will illuminate the interior when the refrigerator door is opened).

Fan

(only with some models)

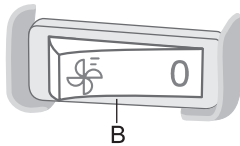
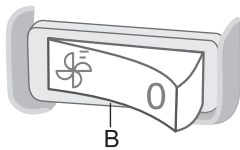

- The fan distributes the cool air in the refrigerator more evenly, speeds up the cooling process, and reduces accumulation of dew on the shelves. It only operates when the compressor is in operation.
- Switching on the fan is recommended as an additional function in the following cases:
 - when room temperature rises (above 30°C),
 - in case of high humidity or when droplets of dew start to accumulate on the shelves,
 - when inserting larger quantities of food (rapid cooling).

Switching the fan on and off

Switch on =  Switch off = 0

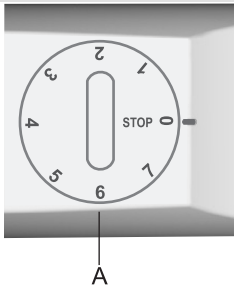

Warning: When the fan is switched on, power consumption increases and the temperature in the refrigerator drops. Hence, it is recommended to reset the temperature in the appliance interior.

- Recommended settings:
 - when fan is activated: position 1-4,
 - without the fan: position 4-7.

Temperature setting for the refrigerator compartment also indirectly affects the temperature in the freezer compartment.

Recommended food arrangement in the appliance

Recommended food arrangement in the appliance

Refrigerator compartment areas:

- **upper area:** canned / preserved food, bread, wine, pastry, etc.
- **medium area:** dairy products, ready-to-eat meals, deserts, juices, beer, cooked food, etc.
- **lower area:** meat, meat produce, delicatessen, etc.
- **vegetable drawer / bin:** fresh fruit, vegetables, salads, root vegetables, potatoes, onions, garlic, tomatoes, tropical fruit, sauerkraut, turnips, etc.

Refrigerator door areas:

- **upper / medium part:** eggs, butter, cheeses, etc.
- **lower part:** beverages, cans, bottles, etc.

Freezer parts:

- **upper shelf position:** freezing
- **lower shelf position:** storage
- **door lining:** packed vegetables, ice-creams, ice, etc.

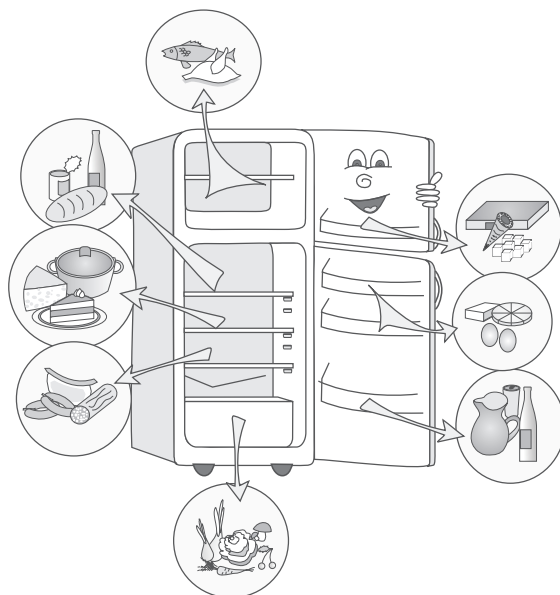

Storing food in the refrigerator

Important warnings on food storage

- ⚠ **Appropriate use of the appliance, appropriate food packaging, maintaining the appropriate temperature and observing the hygienic guidelines will affect decisively the quality of food storage.**
- ⚠ **Observe the best before dates indicated on the product packaging.**
- ⚠ **Food stored in the refrigerator should be placed in closed containers or otherwise suitably packed to prevent emitting scent and moisture.**
- ⚠ **Do not store inflammable, volatile, and explosive substances in the refrigerator.**
- ⚠ **Bottles with high alcohol content should be tightly sealed and stored in an upright position.**
- ⚠ **Some organic solutions, essential oils in lemon and orange peel, butter acid, etc. may damage the plastic surfaces in case of a prolonged contact, causing premature ageing of these materials.**
- ⚠ **Unpleasant smell warns of poor appliance cleanliness or deteriorated food (see Cleaning and Maintenance).**
- ⚠ **Remove perishables from the refrigerator before a longer period of absence from home.**

Refrigerator interior equipment



The equipment depends on the models.

- The shelves can be inserted to any of the shelf guides in the refrigerator interior. They are protected against pulling out. To remove a shelf from the refrigerator, lift it slightly at the front, tilt as required, and pull it out. Food that perishes quickly should be kept at the back of the shelf where the temperatures are lower.
- Certain models are equipped with wire bottle rack which enables placing of bottles on the cork. It is safeguarded against pulling out. It may be pulled out only if empty, by lifting the front part and pulling it towards you. Place the bottle rack in the appliance in such way to avoid obstruction of door closing by the length of the stacked bottles. Maximum load of the rack is 9 bottles of 0,75 l, or 13 kg of total mass - see label at the right side of the interior of the appliance.
- The bin / drawer at the bottom of the refrigerator compartment, under the glass shelf, is intended for storing fruit and vegetables. It provides humidity, thus preventing the food from dehydrating. The food must be appropriately packaged in order to prevent emitting or receiving smell and moisture.
- Interior side of the refrigerator door is fitted with racks and bins intended for storing cheese, butter, eggs, yoghurt, and other smaller packages, tubes, cans, etc. The lower part of the door is fitted with a bottle rack.

Food storage time

Recommended storage time for the refrigerator

Foodsmoked	Time
eggs, marinated meat, smoked meat	up to 10 days
cheese	up to 10 days
root vegetables	up to 8 days
butter	up to 7 days
deserts, fruit, ready-to-eat dishes, raw meat chunks	up to 2 days
fish, raw chopped meat, seafood	up to 1 day

Freezing fresh food and storing frozen food

Freezer interior equipment

- The shelves or bins on the interior side of the freezer door are suitable for storing frozen food that is often in use and hence requires quick access (ice creams, open vegetable packages, etc.)

Freezing process

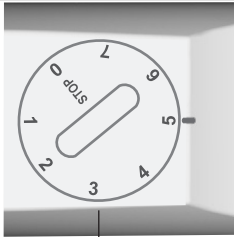

A

⚠ Maximum quantity of fresh food that can be introduced into the appliance at a time is indicated on the label with basic information on the appliance. If this quantity is exceeded, freezing quality will deteriorate, as will the quality of the already frozen food.

Control unit I:

- 24 hours before freezing fresh food, rotate the **A** knob to position between **4** and **6**. Tip the switch to , except in case of appliances of the A+++ energy class.

Control unit II:

- 24 hours before freezing fresh food, rotate the **A** knob to a position between **4** and **6**.

After 24 hours, place the fresh food, distributing them evenly across the **shelf** which should be in the upper position. Fresh food should not be in contact with already frozen packages!

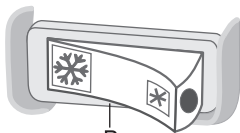

B

SUPER FREEZE ACTIVATED

- After 24 hours, move the food to the **lower part of the freezer compartment** and repeat the freezing process as required.
- When freezing a minor quantity of fresh food (1-2 kg), activating the super freeze function is not required.

Control unit I:

- After freezing, rotate the **A** knob back to the desired setting and use the **B** switch to deactivate the super freeze function.

Control unit II:



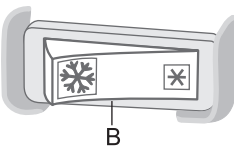

- After completing the freezing process, rotate the **A** knob back to the desired setting.



B

SUPER FREEZE DEACTIVATED

Important warnings on freezing fresh food

-  **The freezer should only be used for freezing food that is appropriate for freezing. The food should always be fresh and of adequate quality.**
-  **Choose an appropriate packaging for the food and package it correctly.**
-  **The packaging should be airtight and watertight to prevent loss of humidity or vitamins from the food.**
-  **Indicate the type of food, quantity, and freezing date on each food package.**
-  **It is important that the food is frozen as quickly as possible; therefore, smaller packages should be preferred. Before freezing, the food should be cooled.**

Storing pre-frozen food

- When storing or using frozen food, observe the manufacturer's instructions. Temperature and best before date are indicated on the packaging.
- Only choose food with undamaged packaging, stored in freezers at temperatures of -18°C or lower.
- Do not buy a food package covered with frost, as this is a sign that the food has been slightly thawed several times. Such food is of lesser quality.
- When transporting frozen food, prevent it from defrosting / thawing. Higher temperature will result in shorter storage time and deteriorated food quality.

Storage times for frozen food

Recommended time for storage in the freezer

Food	Time
fruit, beef	from 10 to 12 months
vegetables, veal, poultry	from 8 to 10 months
venison	from 6 to 8 months
pork	from 4 to 6 months
chopped, dice, or ground meat	4 months
bread, pastry, ready-to-eat meals, lean fish	3 months
triples / innards	2 months
smoked sausage, fatty fish	1 month

Defrosting frozen food

Microorganisms are not destroyed by freezing. After defrosting, their activity is resumed intensively and the food may perish quickly. Therefore, use the thawed food as quickly as possible. Partial thawing decreases the nutritive value of the food, particularly fruit, vegetables, and ready-to-eat food.

Defrosting the appliance

Automatic refrigerator defrosting

The refrigerator does not require defrosting, as ice accumulated on the back wall of the refrigerator compartment interior is melted automatically.

The accumulated ice is thawed when the compressor is not operating. The drops will drip through the opening in the refrigerator back wall into a container above the compressor, from where they will evaporate.

If an excessive layer of ice is accumulated on the refrigerator back wall (3-5 mm), the appliance should be disconnected and defrosted manually.

- The freezer should be defrosted when approximately 3-5 mm of frost or ice is accumulated on the freezer walls.

Control unit I:

- 24 hours before defrosting, rotate the **A knob** to a position between **4** and **6** and activate the super freeze function to additionally cool the food.

Control unit II:

- 24 hours before defrosting, rotate the A knob to a position between **4** and **6**.

Defrosting the freezer

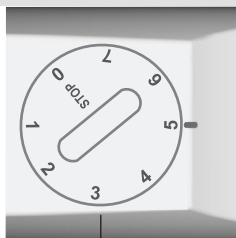

A

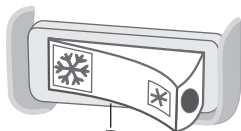

B

Then, take the frozen food from the freezer and protect it from thawing.

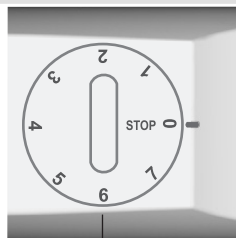

A

- Turn off the appliance – rotate the thermostat knob **A** to the **STOP (0)** position and unplug the power cord from the wall outlet.
- Leave the door open until the frost or ice can be easily removed from the surfaces using e.g. a plastic scraper. Be careful not to damage the freezer interior surfaces. Remove the frost or ice from the freezer using a cloth, before it melts.
- Do not use any electrical devices (e.g. a hairdryer) to defrost the appliance.
- Do not use any defrosting sprays to defrost the freezer as these sprays could damage the plastic parts or harm your health.
- Clean the appliance interior and wipe it dry (see Cleaning the Appliance).

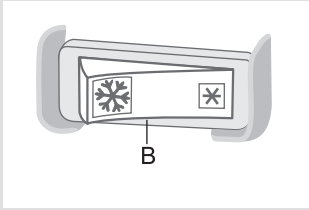

Control unit I:

- Before returning the food into the freezer, turn on the appliance, rotate the **A** knob back to the desired setting and **deactivate** the super freeze function.

Control unit II:

- Before putting the food back into the freezer, connect the appliance to the power mains and rotate the **A** knob back to the desired setting.

Cleaning the appliance

Before cleaning, disconnect the appliance from the power mains – rotate the thermostat knob **A** to the **STOP (0)** position and unplug the power cord from the wall outlet.

- Use a **soft cloth** to clean all surfaces. Cleaners containing **abrasive particles, acids, or solvents, are not appropriate** as they will damage the surface!

Clean the **appliance exterior** with water or a mild solution of suds.

Lacquer-coated and aluminum surfaces can be cleaned with lukewarm water to which some mild detergent was added.

Cleaning agents with minor alcohol content are also acceptable (e.g. window cleaners).

Cleaners with alcohol content are not allowed for cleaning plastic parts.

Clean the appliance **interior** with lukewarm water to which you may add some **vinegar**.

- Placed under the cooling board that cools the refrigerator interior are a trough (groove) and an opening through which melted water is discharged from the appliance interior. The through and the opening should never be blocked; therefore, check them often and clean as required (e.g. using a plastic straw).

- Frost and ice accumulated in a layer of 3-5 mm will cause an increase in power consumption; therefore it should be removed regularly. Do not use any sharp objects, solvents, or sprays.

- **Condenser unit** on the back of the refrigerator should always be kept clean, free of dust or deposit from kitchen smoke. Use a soft non-metal brush or a vacuum cleaner to clean the dust periodically.

- Also clean the **container** above the refrigerator compressor. If it was removed for cleaning, replace it afterwards. Make sure the container is in a horizontal position!

- After cleaning, switch on the appliance and put the food back in.

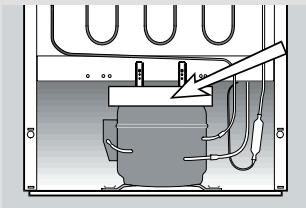
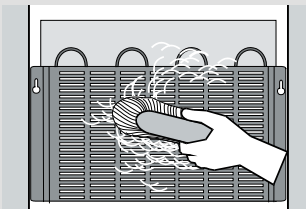

Troubleshooting

Problem:	Cause or remedy:
After connecting to the power mains, the appliance does not operate:	<ul style="list-style-type: none"> • Make sure the wall outlet is powered and that the appliance is plugged in.
Cooling system has been working continuously for a long period of time:	<ul style="list-style-type: none"> • Too high environment temperature. • Door is open too often or it is left open too long. • Door is not closed appropriately (there may be dirt between the door and the refrigerator, the door may be tilted, the seal should be checked, etc.). • Too much fresh food was inserted. • Insufficient compressor and condenser cooling. Check the air circulation behind the appliance and clean the condenser. • Super freeze option is on.
Excessive build-up of ice on the back wall of refrigerator interior may result form the following:	<ul style="list-style-type: none"> • Door is opened to often or it is left open too long. • Warm food was placed in the refrigerator. • Food or a container are in contact with the refrigerator interior back wall. • Poor door sealing. If the seal is dirty or damaged, clean it or replace it.
Water is dripping from the refrigerator:	<ul style="list-style-type: none"> • Blocked water discharge opening; or water from thawed ice is dripping past the water collection trough. • Clean the blocked opening, e.g. using a plastic straw. • If the layer of ice is too thick, defrost the appliance annually (see "Defrosting the appliance").
Door won't open easily:	<ul style="list-style-type: none"> • If you wish to open freezer door immediately or shortly after closing it, you may feel rather strong resistance. When the freezer door is opened, some cool air escapes from the freezer compartment and it is replaced by warm air from the environment. When this air is cooled, a sub-pressure builds up, causing resistance to door opening. After a few minutes, the condition is normalized and the door can be easily opened again.
Replacing the bulb:	<div data-bbox="112 1109 341 1268" data-label="Image"> </div> <ul style="list-style-type: none"> • Before replacing the bulb, disconnect the appliance from the power mains (unplug the power cord from the wall outlet / socket). Insert a screwdriver into the slot in the cover, lift it and remove it. Replace the bulb with a new one (E14, same power rating as the one provided by the manufacturer) and replace the cover. • Do not dispose of the blown bulb with organic waste. • The bulb is considered a consumable and is excluded from any warranty! • Bulb lamps used in this appliance are special purpose lamps selected for household appliances use only. They are not suitable for household room illumination.

If none of the above reasons seems to match your problem, please contact the nearest service center and state the type, model and serial number as indicated on the label with basic information attached in the appliance interior.

Cooling in the refrigerators-freezers is enabled by a cooling system with a compressor (with some appliances also a fan), which emits a certain level of noise during operation. The level of noise depends on installation, proper use, and appliance age.

- **After appliance startup**, the compressor may be somewhat louder (fluid noise, noise caused by refrigerant flowing through the system). This is not a sign of malfunction and it will not affect the appliance useful life. Eventually, the level of this noise will be reduced.
- Occasionally, **sudden or louder noise** may appear during appliance operation, which will appear uncommon; these are mostly the result of improper installation:
 - The appliance must be placed horizontally and firmly on a solid base.
 - The appliance should not be in contact with the wall or adjacent elements.
 - Make sure the appliance interior equipment is appropriately fitted and that the noise is not caused by vibrating cans, bottles, or other containers in contact with each other.

WE RESERVE THE RIGHT TO CHANGES THAT TO NOT AFFECT THE APPLIANCE FUNCTIONALITY.

Instructions for use of the appliance can also be found on our website at www.gorenje.com / < <http://www.gorenje.com> />

TOP MOUNT BASIC



305888

en (10-14)