gorenje⁺

Instructions for use

GDF67088



Freezer

We thank you for the confidence you have shown by purchasing our appliance.
We wish you a lot of pleasure using the appliance.

The appliance is intended solely for household use.

The upright freezer is intended for use in households, for freezing fresh food and long-term storage of frozen food (up to one year, depending on the type of food).

Important warnings	4
A few tips on how to save power with your refrigerator-freezer combo	5
Appliance description	6
Installation and connection	7
Operating the appliance.....	8
Freezing and storing frozen food.....	10
Defrosting the appliance.....	12
Cleaning the appliance	12
Troubleshooting	13
Information on appliance noise	14

Important warnings

- The appliance is manufactured in compliance with all relevant safety standards; however, it is recommended that persons with impaired physical, motional, or mental abilities, or persons with inadequate experience and knowledge, do not use the appliance without due supervision. The same recommendation applies to minors using the appliance. Cleaning and user maintenance shall not be made by children without supervision.
- Before connecting the appliance read these instructions carefully. They describe the appliance and provide instructions for its safe and correct use. The instructions are prepared for different types and models of the appliance so they may contain descriptions of functions and components your appliance may not have.
- Remove the wrapping protecting the appliance during transport.
- Wrappings contain environmentally friendly materials which can be recycled, recovered or disposed off without threat to the environment.
- On the door corners (on freestanding appliances) or on the housing of the appliances (on built-in appliances) the spacers are installed, which should be removed and replaced with the attached spacer-plugs.
- Before connecting the appliance to the mains supply, leave it in upright position for about 2 hours. This will reduce possibility of malfunctions in the cooling system resulting from prior transport and handling.
- The appliance must be connected to the mains supply in accordance with the standing regulations and local requirements.
- The appliance must not be used in open air or exposed to weather precipitation.
- Always disconnect the appliance from power supply (pull the power cord from wall socket) before cleaning and before replacing the light bulb.
- If the power supply cord is damaged, in order to avoid hazard it must be replaced by the service or by qualified personnel.
- In case of longer disuse first turn the appliance off with the ON/OFF button and disconnect it from mains supply. Empty the appliance, clean the interior and leave the door ajar.
- For the protection of environment deliver the obsolete appliance to the authorized scrap appliance dealers.
- Never let the children play with the appliance.
- Self closing shear door hinge pulls the door to the cabinet just before closing, thereby preventing the door to remain ajar. Equally it limits the door opening angle and prevents damage to adjacent elements.
- Rating plate with basic information is located in the interior of the appliance. If the sticker plate is not suitable for your language, replace it with the attached one.
- **WARNING!** Keep ventilation openings, in the appliance enclosure or in the built-in structure, clear of obstruction.
- **WARNING!** Do not use mechanical devices or other means to accelerate the defrosting process, other than those recommended by the manufacturer.
- **WARNING!** Do not damage the refrigerant circuit.

- **WARNING!** Do not use electrical appliances inside the food storage compartments of the appliance, unless they are of the type recommended by the manufacturer.



The symbol on the product or on its packaging indicates that this product may not be treated as household waste. Instead it shall be handed over to the applicable collection point for the recycling of electrical and electronic equipment. By ensuring this product is disposed of correctly, you will help prevent potential negative consequences for the environment and human health, which could otherwise be caused by inappropriate waste handling of this product. For more detailed information about recycling of this product, please contact your local city office, your household waste disposal service or the shop where you purchased the product.

A few tips on how to save power with your refrigerator-freezer combo

- Observe the installation instructions.
- Do not open the appliance door more frequently than necessary.
- Occasionally check whether air can circulate freely behind the appliance.
- Condenser unit mounted on the appliance back wall must be kept clean at all times (see section "Cleaning the appliance").
- If the seal is damaged or loose, replace it as soon as possible.
- Store your food in closed containers or other appropriate packaging.
- Before placing the food in the refrigerator, let it cool down to room temperature.
- Defrost your frozen food in the refrigerator compartment.
- Remove the freezer drawers and door as described in the instructions, in order to make use of the entire capacity.
- Defrost your conventional freezer when a frost layer approximately 3-5 millimetres thick has accumulated on the surfaces in the freezer compartment.
- Make sure the shelves are evenly distributed and that the food is arranged in a way that allows free circulation of air (heed the recommended food arrangement as described in the instructions).
- In appliances fitted with a fan, do not block the fan slots.

Appliance description

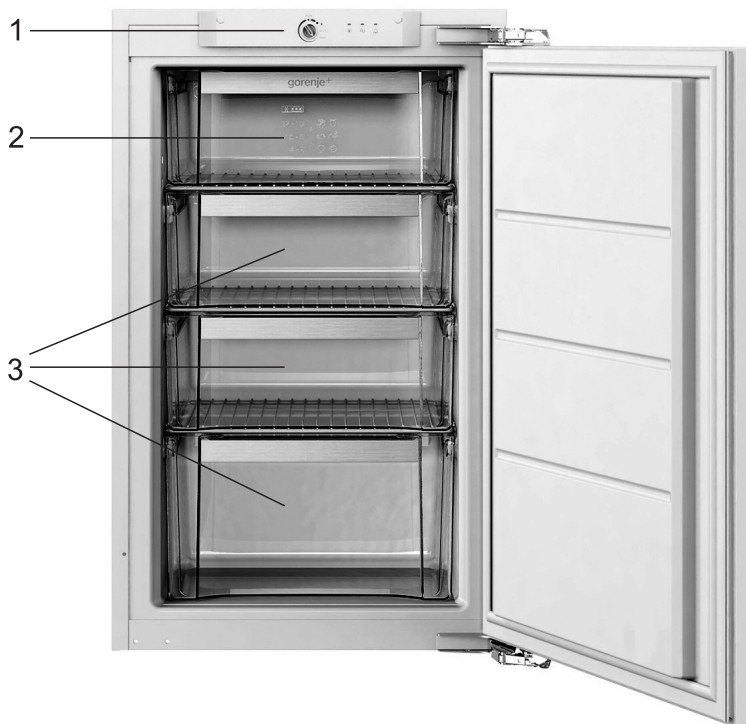

- 1 Control unit
- 2 Freezing compartment
- 3 Storage compartment

- Drawers are protected against accidental extraction. To extract the drawer from the appliance, open it and lift front part upwards, then pull it out.

Installation and connection

Selecting the location

- Place the appliance in dry and well aired room. The appliance operates best at temperature ranges indicated in the chart below. Relevant class of the appliance is indicated on the rating plate.

Class	Ambient temperature
SN (subnormal)	from + 10°C to + 32°C
N (normal)	from + 16°C to + 32°C
ST (subtropical)	from + 16°C to + 38°C
T (tropical)	from + 16°C to + 43°C

Positioning the appliance

Positioning the appliance requires two persons in order to avoid injuries or damage to the appliance.

- Place the appliance flatly and firmly on a solid base.
- Avoid exposing the appliance to direct sunlight or heat sources. If this is not feasible, install insulation plate between the appliance and adjacent heat source.
- Be sure to leave enough space for cooling of condenser (distance from the wall or the opening should be 200 cm²). Distance to the cabinet above the appliance should be at least 5 cm.
After the installation, the appliance mains plug should be accessible!

Connecting to power supply

- Use the power cord to connect the appliance to the mains power. Wall outlet must be fitted with ground terminal (safety socket). Required nominal voltage and frequency are indicated on the relevant label or rating plate of the appliance.
- Mains power connection and grounding must be made in line with standing regulations and local requirements.

The appliance is able to accommodate minor temporary voltage tolerances, but they may not exceed -6% to +6%.

Operating the appliance

CONTROL UNIT I

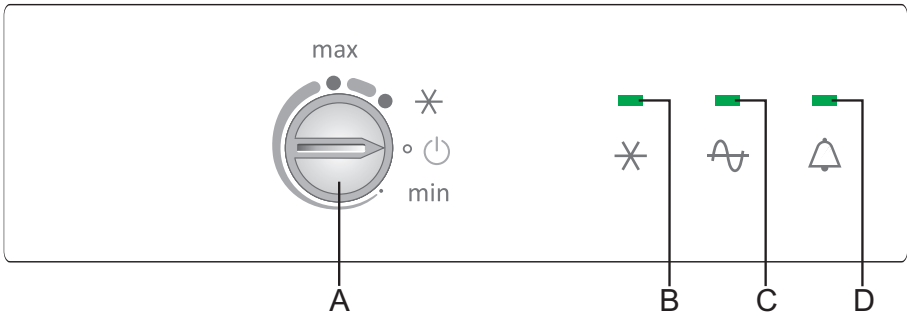

CONTROL UNIT II

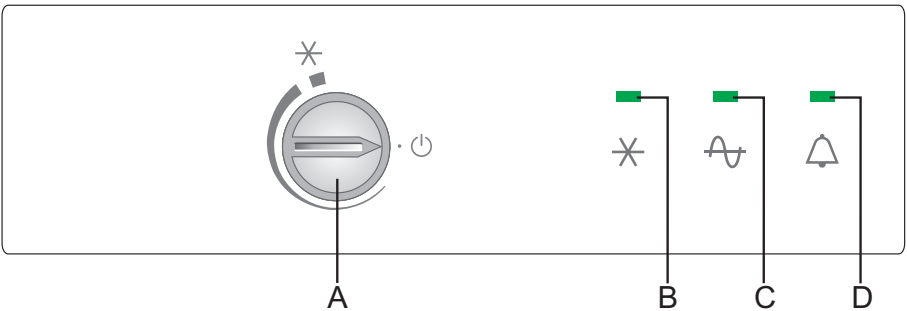

- A Temperature settings knob – Switching the appliance on/off – Activating the super freeze function**
- B Signal light on:** Super freeze function is activated
- C Signal light on:** The appliance is powered (there is voltage in the appliance)
- D Signal light on/ flashing:** High temperature alarm

Switching on the appliance

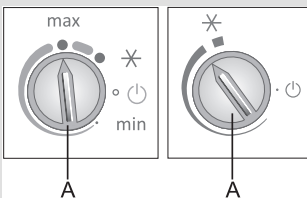

Rotate the thermostat knob **A** clockwise towards the thicker end of the sign.

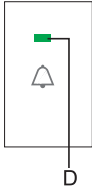

Control unit I:

When the appliance is switched on for the first time, the **D** signal light will be on. It will go off automatically when the freezer cools down to a temperature that no longer presents danger of food spoilage.

Control unit II:

When the appliance is switched on for the first time, there is a 24-hour delay in temperature alarm operation since the appliance will not have reached the adequate temperature. Thus, unnecessary activation of alarm is prevented.

Switching off the appliance

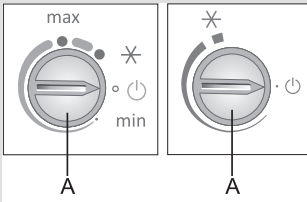

Rotate the **A** knob back to the position in which the arrow is aligned with the symbol  (appliance will remain powered, i.e. there will still be electric current in the appliance).

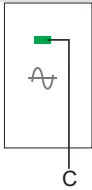

The signal light **C** will remain on.

Selecting the temperature in the appliance

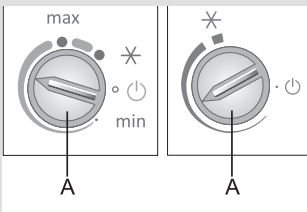

- Recommended setting for the thermostat knob **A** is half way between the thinner and the thicker end of the sign.
- A change in the environment temperature will affect the temperature in the appliance. The thermostat knob setting should be adjusted accordingly.

Positions towards the thicker part of the sign mean a lower temperature in the appliance (cooler). Settings towards the thinner part of the marking mean a higher temperature (warmer).

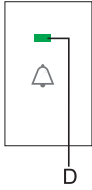

Signal light **D** will be on/will flash when the temperature in the freezer rises to a level that is too high, and goes off when the temperature drops back to a level that no longer represents food spoilage hazard (see section »Troubleshooting«).

Freezing and storing frozen food

Freezing process

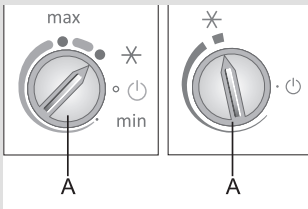

! Maximum quantity of fresh food that can be introduced into the appliance at a time is indicated on the label with basic information on the appliance. If this quantity is exceeded, freezing quality will deteriorate, as will the quality of the already frozen food.

- Activate the super freeze function 24 hours before freezing fresh food:
 - rotate the **A** button to the * position (signal light **B** will light up)

After 24 hours, place the fresh food in the freezing compartment, but not more than 5 kilograms to each compartment. Make sure the fresh food is not in contact with the food that is already frozen.

- When freezing smaller quantities of food (1-2 kilograms), activating the super freeze function is not required.
- After the end of the freezing process, rotate the **A** dial back to the desired setting, even if the **B** signal light is not on (this means that sufficiently low temperature has already been reached).
- If the freezer boost is not deactivated manually, it will be automatically switched off after approximately 2 days. Then the temperature of the freezer compartment returns to the most recently set value (knob position remains at *).
- In order to make use of the entire freezer volume, you may remove the drawers and place the food packages onto the shelf.

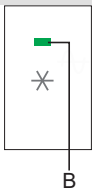

Important warnings on freezing fresh food

! The freezer should only be used for freezing food that is appropriate for freezing. The food should always be fresh and of adequate quality.

! Choose an appropriate packaging for the food and package it correctly.

! The packaging should be airtight and watertight to prevent loss of humidity or vitamins from the food.

! Indicate the type of food, quantity, and freezing date on each food package.



It is important that the food is frozen as quickly as possible; therefore, smaller packages should be preferred. Before freezing, the food should be cooled.

Storing pre-frozen food

- When storing or using frozen food, observe the manufacturer's instructions. Temperature and best before date are indicated on the packaging.
- Only choose food with undamaged packaging, stored in freezers at temperatures of -18°C or lower.
- Do not buy a food package covered with frost, as this is a sign that the food has been slightly thawed several times. Such food is of lesser quality.
- When transporting frozen food, prevent it from defrosting / thawing. Higher temperature will result in shorter storage time and deteriorated food quality.

Storage times for frozen food

Recommended time for storage in the freezer

Food	Time
fruit, beef	from 10 to 12 months
vegetables, veal, poultry	from 8 to 10 months
venison	from 6 to 8 months
pork	from 4 to 6 months
chopped, dice, or ground meat	4 months
bread, pastry, ready-to-eat meals, lean fish	3 months
tripes / innards	2 months
smoked sausage, fatty fish	1 month

Defrosting frozen food

Microorganisms are not destroyed by freezing. After defrosting, their activity is resumed intensively and the food may perish quickly. Therefore, use the thawed food as quickly as possible. Partial thawing decreases the nutritive value of the food, particularly fruit, vegetables, and ready-to-eat food.

Icemaker function



Remove the cover of the ice mold (only supplied with some models) and fill it with cold water or other fluid suitable for freezing, up to the marking. Close it and place in on the freezer shelf with mold-side down.

The ice mold enables making eight cubes of ice. We recommend making a stock of ice cubes. To take the cubes from the mold, pour some cold water over it, shake it, open the cover, and shake the cubes from the mold.

Defrosting the appliance

Defrosting traditional freezer

- The freezer should be defrosted 2 – 3 times a year, or more often if appliance door is opened more frequently. Moving the cold accumulators (only with some models) directly onto the frozen food in the upper freezer compartment may reduce the number of times the freezer needs to be defrosted.
- 24 hours before defrosting, activate the freezer power boost to additionally cool the food (see chapter “Freezing process”).

After 24 hours, remove the frozen food from the freezer and protect them from thawing.

- Disconnect the appliance – rotate the thermostat knob **A** to the  position and unplug the power cord from the wall outlet.
- Place absorbent cloths on the bottom of the freezer to absorb the water as the ice melts, and replace them as necessary.
- Do not use electrical appliances to defrost the appliance (hairdryer etc.);
- When defrosting the refrigerator, do not use any defrosting sprays as these may damage the plastic surfaces or harm your health.
- Clean the appliance interior and wipe it dry (see cleaning the appliance).
- Before putting the food back into the freezer, connect the appliance to the power mains and rotate the **A** knob back to the desired setting.

Cleaning the appliance

Before cleaning, unplug the appliance from the power mains – rotate the thermostat knob **A** to position  and unplug the power cord from the wall outlet.

- Use a **soft cloth** to clean all surfaces. Cleaners containing **abrasive particles, acids, or solvents, are not appropriate** as they will damage the surface.

Clean the **appliance exterior** with water or a mild solution of suds. Lacquer-coated and aluminum surfaces can be cleaned with lukewarm water to which some mild detergent was added. Cleaning agents with minor alcohol content are also acceptable (e.g. window cleaners). Cleaners with alcohol content are not allowed for cleaning plastic parts.

Clean the appliance **interior** with lukewarm water to which you may add some **vinegar**.

- A thick layer of frost will increase power consumption; therefore, defrost the appliance as soon as possible. Do not use any sharp objects, solvents, or sprays.

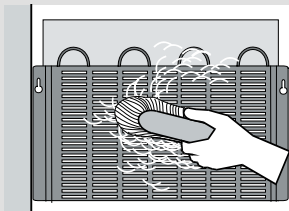

- The **condenser** unit mounted on the (exterior) back wall should always be kept clean, free of dust or similar deposits. Occasionally clean the dust using a soft non-metal brush or a vacuum cleaner.
- After cleaning, switch on the appliance and put the food back in.

Troubleshooting

Problem:	Cause or remedy:
After connecting to the power mains, the appliance does not operate:	<ul style="list-style-type: none"> • Make sure the wall outlet is powered and that the appliance is plugged in.
Cooling system has been working continuously for a long period of time:	<ul style="list-style-type: none"> • Too high environment temperature. • Door is open too often or it is left open too long. • Door is not closed appropriately (there may be dirt between the door and the refrigerator, the door may be tilted, the seal should be checked, etc.). • Too much fresh food was inserted. • Insufficient compressor and condenser cooling. Check the air circulation behind the appliance and clean the condenser.
Ice accumulation in the freezer interior is a result of:	<ul style="list-style-type: none"> • Poor door sealing. If the seal is dirty or damaged, clean or replace it. • Door is opened too often or left open too long. • Placing warm food into the freezer.
Signal light D is on/is flashing:	<ul style="list-style-type: none"> • Frequent opening of the door, door open too long. • Door not closed properly (particle between door gasket, sagged door, damaged gasket, etc...). • Excessively long power failure. • Excessive quantity of fresh food inserted at once.
Door won't open easily:	<ul style="list-style-type: none"> • If you wish to open freezer door immediately or shortly after closing it, you may feel rather strong resistance. When the freezer door is opened, some cool air escapes from the freezer compartment and it is replaced by warm air from the environment. When this air is cooled, a sub-pressure builds up, causing resistance to door opening. After a few minutes, the condition is normalized and the door can be easily opened again.
Occurrence of murmur after closing the door:	<ul style="list-style-type: none"> • After closing the door, some murmur can occur. This phenomenon is normal and is due to pressure equalisation.

If none of the above reasons seems to match your problem, please contact the nearest service center and state the type, model and serial number as indicated on the label with basic information attached in the appliance interior.

Cooling in the refrigerators-freezers is enabled by a cooling system with a compressor (with some appliances also a fan), which emits a certain level of noise during operation. The level of noise depends on installation, proper use, and appliance age.

- **After appliance startup**, the compressor may be somewhat louder (fluid noise, noise caused by refrigerant flowing through the system). This is not a sign of malfunction and it will not affect the appliance useful life. Eventually, the level of this noise will be reduced.
- Occasionally, **sudden or louder noise** may appear during appliance operation, which will appear uncommon; these are mostly the result of improper installation:
 - The appliance must be placed horizontally and firmly on a solid base.
 - The appliance should not be in contact with the wall or adjacent elements.
 - Make sure the appliance interior equipment is appropriately fitted and that the noise is not caused by vibrating cans, bottles, or other containers in contact with each other.

WE RESERVE THE RIGHT TO CHANGES THAT TO NOT AFFECT THE APPLIANCE FUNCTIONALITY.

Instructions for use of the appliance can also be found on our website at www.gorenje.com / < <http://www.gorenje.com> />

gorenje⁺



476452