

Hisense

LC **LASeR**
cinema



USER MANUAL

Read the manual carefully and ensure you have fully understood its contents before operating this device for the first time.

English

In order to promote environmental protection and assume social responsibility, we strongly recommend you to acquire the electronic user manual of multi-language through the QR code below.



Zeskanuj kod QR dla elektronicznych instrukcji obsługi w innych językach.

Nuskaitykite QR kodą norėdami rasti elektroninį vartotojų vadovą kitomis kalbomis

Skenējiet QR kodu , lai iegūtu elektroniskās lietotāja rokasgrāmatas citās valodās.

Skaneerige QR-koodi elektrooniliste kasutusjuhendite jaoks teistes keeltes.

Naskenujte QR kód pro elektronické uživatelské příručky v jiných jazycích.

Prehľadajte kód QR pre elektronické príručky používateľov v iných jazykoch

Scan de QR-code voor elektronische gebruiksaanwijzingen in andere talen.

Poskenirajte QR kodo za navodila za uporabo v ostalih jezikih.

Olvassa be a QR-kódot a többi idegen nyelvű elektronikus felhasználói kézikönyvekért.

Skenirajte QR kod za elektronske korisničke priručnike na drugim jezicima.

Сканирайте QR кода за електронни ръководства за потребителя на други езици.

Σαρώστε τον κωδικό QR για ηλεκτρονικά εγχειρίδια χρήσης σε άλλες γλώσσες.

Important Notice

Paragraphs beginning with the symbol  indicate important instructions, tips or conditions for the following settings.



For your own safety and the optimal performance of your device, ensure to read the safety instructions before performing any installation.

Compatibility with 3rd party products, software and services are not guaranteed. We cannot be held liable for any damage or loss suffered whilst operating, using or connecting to incompatible devices or apps.

The recording and playback of content on this or any other device may require permission from the owner of the copyright or other such rights in that content. It is your responsibility to ensure that your use of this or any other device complies with applicable copyright legislation in your country. Please refer to that legislation for more information on the relevant laws and regulations involved or contact the owner of the rights of the content you wish to record or playback.

Read these instructions
Follow all instructions
Heed all warnings
Keep these instructions
All rights reserved.



Safety Instructions

To ensure safe and correct use of this product, always comply with the following precautions to avoid dangerous situations and damage to your unit:

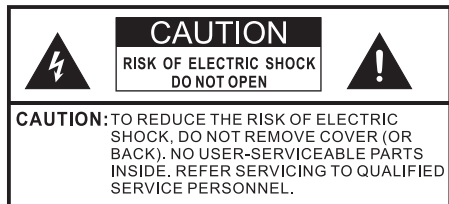

The lightning flash with arrowhead symbol, within an equilateral triangle is intended to alert the user to the presence of uninsulated dangerous voltage within the product's enclosure that may be of sufficient magnitude to constitute a risk of electric shock.



The exclamation point within an equilateral triangle is intended to alert the user to the presence of important operating and maintenance (servicing) instructions in the literature accompanying the appliance.



AC voltage: This symbol indicates that the rated voltage marked with the symbol is AC voltage.



Class I product: This symbol indicates that it requires a safety connection of protective earthing (ground).

The intended use and ambient conditions for this device

This device is intended for the rendering of video and audio signals, on a table-top, in a home or office environment. It must not be used in rooms with a high level of humidity or dust concentration. The warranty is only valid if used as intended by the manufacturer.



High humidity and dust concentration may lead to current leaks in the device. To reduce the risk of fire or electrical shock:

- Do not expose this unit to rain, moisture, dripping or splashing water, and do not place objects filled with liquids, such as vases, cups, etc. on or over the unit.
- Do not touch the device with wet hands.
- Do not expose to direct air-conditioning and keep candles or other naked flames away from the device at all times.

If the device is moved from a cold environment to a hot environment, leave it switched off for at least an hour to avoid condensation. If used outside, make sure it is protected from moisture.

If you notice anything unusual, immediately remove the power plug.

In case of fire, use preferably a CO₂ gas or powder fire extinguisher. If such extinguishers are not accessible, try to isolate the electrical supply before using a water fire extinguisher.

A Laser Cinema may fall, causing serious personal injury or death. Many injuries, particularly to children, can be avoided by taking simple precautions such as:

- ALWAYS use cabinets or stands or mounting methods recommended by the manufacturer of the Laser Cinema.
- ALWAYS use furniture that can safely support the Laser Cinema.
- ALWAYS ensure the Laser Cinema is not overhanging the edge of the supporting furniture.
- ALWAYS educate children about the dangers of climbing on furniture to reach the Laser Cinema or its controls.
- ALWAYS route cords and cables connected to your Laser Cinema so they cannot be tripped over, pulled or grabbed.
- NEVER place a Laser Cinema in an unstable location.
- NEVER place the Laser Cinema on tall furniture (for example, cupboards or bookcases) without anchoring both the furniture and Laser Cinema to a suitable support.
- NEVER place the Laser Cinema on cloth or other materials that may be located between the Laser Cinema and supporting furniture.
- NEVER place items that might tempt children to climb, such as toys and remote controls, on the top of the Laser Cinema or furniture on which the Laser Cinema is placed.

If your existing Laser Cinema is being retained and relocated, the same considerations as above should be applied.

■ Power Supply

Incorrect voltages can damage the device. Only connect this unit to a power supply with the correct voltage and frequency noted on the type plate, using the supplied power cable.

The power plug must be easily accessible so that the device can be disconnected at all time. The unit is live, even if in standby mode, as long as the unit is connected to a power outlet.

It is recommended that this unit is placed on a dedicated circuit.

- Do not overload the power outlets by connect too many appliances to the same outlet. Overloaded wall outlets, extension cords, etc. are dangerous and can result in electric shock and fire.

After power off, don't turn it on again in 5 seconds. Frequent switching power supply in a short period of time can cause abnormal device.

The apparatus shall be connected to a MAINS socket outlet with a protective earthing connection.

■ Power plug and power cable

- Do not touch the power plug with wet hands.
- Do not place heavy objects on the power cable. Route the cable so that it is not kinked or laid over sharp edges, walked on or exposed to chemicals. A power cable with damaged insulation can cause electric shock and fire.
- Pull the power plug, NOT on the cable when disconnecting. The cable can become damaged and cause a short circuit if pulled on.
- Do not place the power cable near a high temperature object.
- Do not move the device with the power cable plugged into a socket.
- Do not use a damaged or loose power cable, or a damaged socket outlet.
- Do not use any power cords other than the one supplied with this unit.
- MAIN plug on the power cord is used as the disconnect device, the disconnect device and socket-outlet shall be easily accessible.

■ Air ventilation and high temperatures

Install your device only where there is proper ventilation, and ensure that there is at least 20 cm free space on the sides and 5 cm free space on the back unit for air circulation. Excessive heat and obstruction of ventilation could lead to fire or early failure of some electric components.

- Do not block any ventilation openings with newspapers, tablecloths, curtains, etc.
- Do not dry clothing etc. on top of the unit.
- Take care not to touch the ventilation openings since they may become hot.
- Do not insert foreign objects into the device through the vents.

■ Warning about off-gassing

New furniture, carpet, paint, building materials and electronics can release chemicals into the air through evaporation. After you set your device up and turn it on for the first time, you may notice a slight smell within a couple of hours. This is because some components of device are heating up for the first time. The materials that we use fully meet the environmental requirements and regulations. Your device is working just fine and the fumes from the off-gassing will diminish eventually.

■ Supervision

- Do not let children play unsupervised close to the device. It could tip over, be pushed off or pulled down from the stand surface and injure someone.
- Do not allow a switched-on device to run unattended.

■ Volume

Loud music and noises can lead to irreversible damage to your ears. Avoid extreme volume, especially over long periods and when using headphones.

If you hear a drumming noise in your ears, turn down the volume or temporarily stop using headphones.

■ Thunder Storms

Pull out the power plug from the device during a thunderstorm. Overvoltage caused by lightning strikes can damage the device via the wall socket.

■ Long periods of absence

As long as the power plug is connected to a live socket outlet, the device will consume power even in standby mode. The power plug should be disconnected out during long periods of absence.

■ Cleaning and care

CAUTION:

Unplug the power cord prior to cleaning the device.

Clean the device, the screen, and the remote control with a soft, moist, clean and color-natural cloth only. Do not use any chemicals.

- Do not subject the surfaces to insect repellent, solvent, thinner or other volatile substances. This may degrade the surface quality.

- Do not spray water or other liquids directly on the device. Liquid inside the device could lead to product failure.
- The surface of the display panel is treated and may be easily damaged. Take care not to scratch it with fingernails or other hard objects.
- Also wipe the power plug with a dry cloth at regular intervals.

■ Service/Repair

Never remove the cover/back of the device; there are no user serviceable parts inside. Refer all service to qualified service personnel.

■ Packaging

Keep the anti-moisture materials and plastic bags out of reach of children.

Plastic bags can cause suffocation and the anti-moisture material is harmful if swallowed. If swallowed by mistake, force the patient to vomit and visit the nearest hospital.

■ Modification

Do not attempt to modify this product in any way. Unauthorized modification could void the warranty of this unit, cause electric shock and fires.

■ Remote Control batteries

- Incorrect installation may cause battery leakage, corrosion and explosion.
- Replace only with the same or equivalent type.

- Do not mix old and new batteries.
- Do not mix different battery types.
- Do not use rechargeable batteries.
- Do not burn or break up batteries.
- Be sure to dispose of batteries correctly.
- Do not expose batteries to excessive heat such as sunshine, fire or the like.

■ Disposal

Refer to the recycling section of this manual.

■ Laser

Do not look directly at the lens when this device is on because the laser light may damage your eyes!

- This product comes with a laser module. Do not tear or modify this device in any manner; otherwise, it may result in personal injury.

RG2

As with any bright light source, DO NOT STARE INTO THE BEAM IEC 62471-5: 2015

CLASS 1 LASER PRODUCT

$\lambda = 455\pm 6\text{nm}$

Wavelength 455±6nm

CLASS 1 LASER PRODUCT IEC 60825-1: 2014

CAUTION:

Use of controls or adjustments or performance of procedures other than those specified herein may result in hazardous radiation exposure.

- If this device requires a repair, please wear laser eye protection with an optical density OD that is 4 or higher and has a wave length of 445-465nm.
- Do not place any water-containing vessel on this device, such as cosmetics or liquid medicine.
- If any object or water enters this device, please unplug this device and contact the service staff of Hisense.
- Do not place any exposed fire source (e.g. burning candle) on this device. Keep away from high temperature and heat.
- Do not expose the battery to direct sunlight or candle light.
- Keep air vents on both sides clear from any objects to prevent the device from overheating inside.
- To avoid a short circuit, product damage or electric shock, do not use any sharp object or metal to touch the ports or other openings on the Laser Cinema.
- If this device has been in a warm environment, allow any built-up condensation to evaporate first BEFORE you switch the device on.
- Do not allow a child to stand on or climb up this device.
- Do not place any object above or in front of the lens because the laser light could cause the object to become flammable.
- Clean the lens periodically with a clean cloth and make sure the Laser Cinema is turned off before you start.

Congratulations on the purchase of your new Laser Cinema! This Manual will walk you through a few easy steps to set up your Laser Cinema.

Please visit Hisense official website for more details.

Product image is only for reference, actual product may vary in appearance.

Parts of the software function changes with the system upgrade.

Table of Contents

Accessories List	1
Laser Cinema Diagram	2
STEP 1. Mount the Screen	2
STEP 2. Install the Laser Cinema	2
STEP 3. Adjust the Display Image and the Screen	6
STEP 4. Use Your Remote	8
STEP 5. Proceed through the Screen Setup Menu	10
Maintenance & Quick Problem-Solving Tips	11
Product Specifications	13
Recycling / Licenses	14

Accessories List

- Laser Cinema × 1
- Remote control × 1
- AA or AAA batteries × 2
- Gloves for handling the Laser Cinema × 2
- Power cord × 1
- Laser Cinema User Manual × 1
- Laser Cinema European Guarantee × 1
- Cleaning kit for the lens × 1
- C-shape blocks × 2
- C-shaped Block Installing Instruction × 1

NOTE: The accessories may be different from the list above due to different models, countries/regions. Please refer to the actual accessory bag.

Laser Cinema Diagram

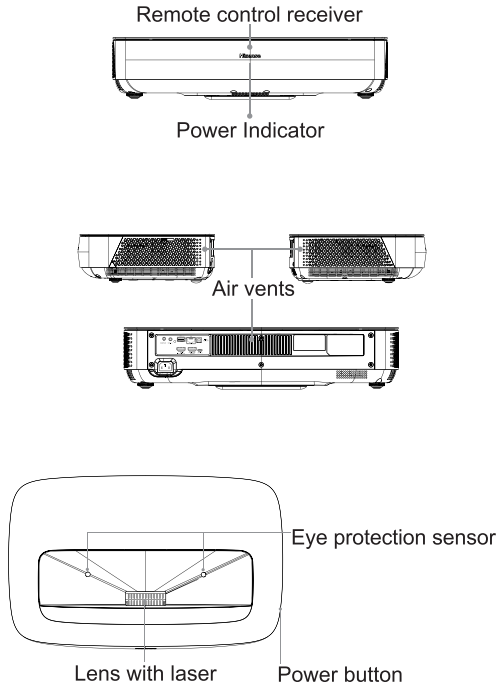

STEP 1 Mount the Screen

If you have purchased a screen, then refer to the specific screen installation guide.

STEP 2 Install the Laser Cinema

We strongly recommend that two people handle this device when moving it from one place to another. Be sure to protect the lens when you handle this device.

We recommend to connect all cables to the ports on the back of the Laser Cinema before positioning the Laser Cinema. (Audio, video, Ethernet cables and external devices are not included.)

Check to ensure that you have selected the right cables for the ports and that they are connected securely. Loose connections can affect the quality of the picture image and colour.

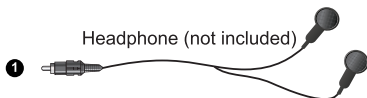
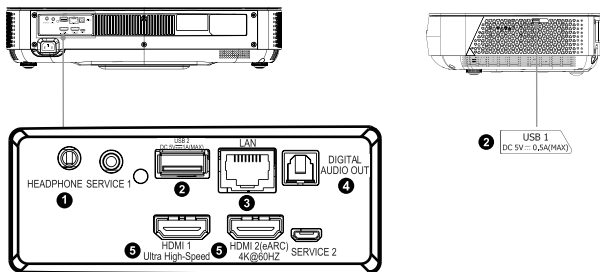

Headphone (not included)

- Excessive sound pressure from earphones and headphones can cause hearing loss.



NOTE:

- When connecting a hard disk or a USB hub, always connect the mains adapter of the connected device to the power supply. Exceeding a total current consumption may result in damage. The USB 1.1 and USB 2.0 devices maximum current consumption are 500mA. The USB 3.0 device maximum current consumption is 1A.
- For individual non-standard high-capacity mobile hard disk, if its impulse current is greater than or equal 1A, it may cause Laser Cinema-rebooting or self-locking. So the Laser Cinema does not support it.
- The USB port supports a voltage of 5V.

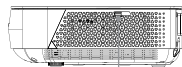

2 USB 1
[DC 5V - 0.5A(MAX)]

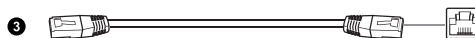

3 Ethernet (you will need a router for Internet connectivity)



4 Digital audio adapter

External audio devices

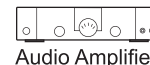

External AV devices

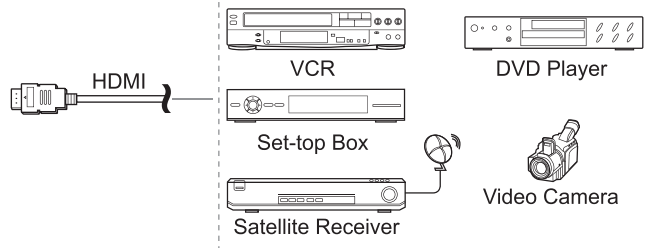

LAN (Wired setup)

- Connect your Laser Cinema to your network by connecting the LAN port on the back of your Laser Cinema to an external modem or router using a LAN (Ethernet/Cat 5) cable. See the illustration below.

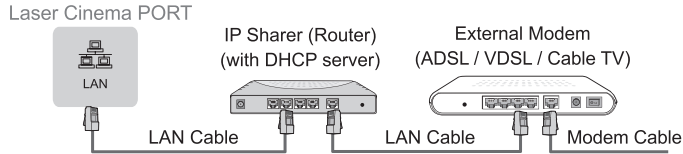

Wireless setup

- Connect your Laser Cinema to your network wirelessly, you need a wireless router or modem. See the illustration below.



NOTE:

- You must use the built-in Wireless LAN Adapter to use a wireless network because the set doesn't support external USB network adapters.
- If the wireless router supports DHCP, your Laser Cinema can connect more easily to the wireless network.
- If you apply a security system other than the systems listed below, it will not work with the Laser Cinema.
security system: WPA, WEP, WPA2.
- In order to guarantee smooth network, the distance between router and Laser Cinema should be less than 10 metres.

Plug the power cord into a wall outlet.

Press the POWER button to turn on the Laser Cinema.

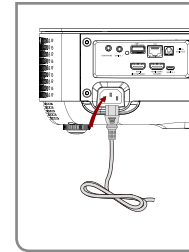

! WARNING: Insufficient ventilation space will cause this device to overheat or become damaged.

- Do not block the air vents or place any object on this device.
- Do not place this device in any narrow, enclosed or poorly ventilated space.

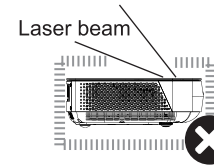

At a minimum, leave the amount of space shown in the diagram below for this device to have proper ventilation.

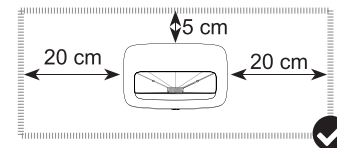
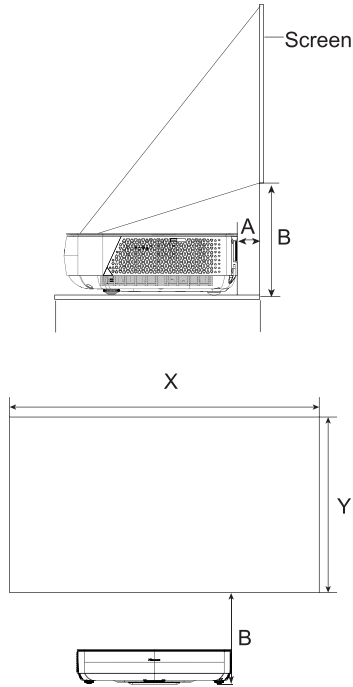

Image size and projection distance

NOTE: The sizes of the screen for each projection distance may differ depending on the actual installation environment.



Screen Size (inch)	X(mm)	Y(mm)	A(mm)	B(mm)
80	1771	996	215	312
90	1993	1121	259	353
100	2214	1245	318	382
110	2435	1370	374	412
120	2657	1494	429	442

STEP 3 Adjust the projected image and the console **PARALLEL THE BOTTOM OF THE IMAGE WITH THE SCREEN**

- Follow the steps in the order below, only if they apply to your situation.
- Adjust the screen using the mount bracket until it's parallel with the screen.
- Use the wrench to rotate the feet with an overlooking view, and don't look directly at the lens when the console is on because the laser light may damage your eyes.

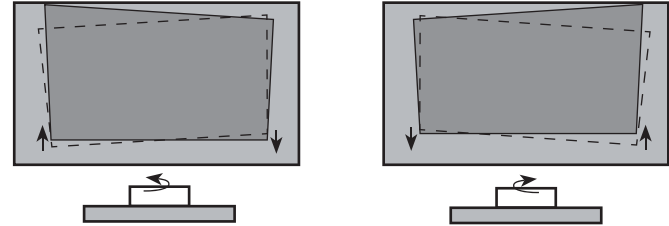

If the bottom of the image is lower on the left(right) and high on the right(left) rotate the console counterclockwise(clockwise) until the bottom of the image is parallel with the screen.

FIT THE BOTTOM OF THE IMAGE TO THE SCREEN

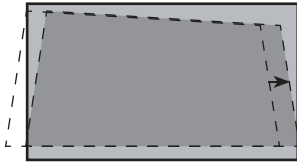

Move the console to the right

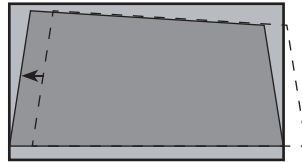

Move the console to the left

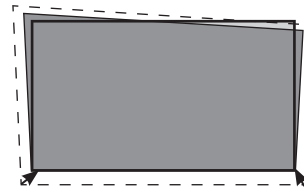

Move the console closer to the screen

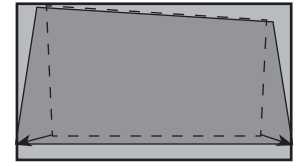

Move the console farther from the screen

ADJUST THE UPPER-RIGHT/UPPER-LEFT OF THE IMAGE

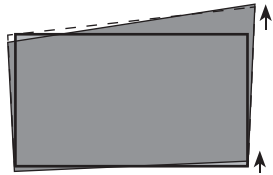

Rotate the front-right foot clockwise

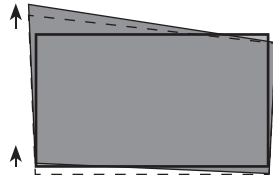

Rotate the front-left foot clockwise

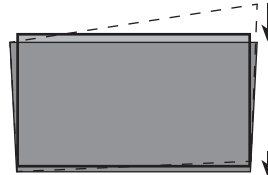

Rotate the console counterclockwise until the bottom of the image is parallel to the screen

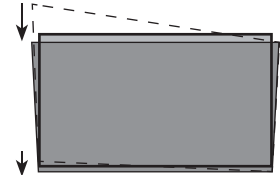

Rotate the console clockwise until the bottom of the image is parallel to the screen

FILL THE TOP OF THE IMAGE TO THE SCREEN



Rotate the left and right-front feet clockwise.

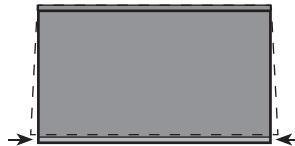











Rotate the left and right-back feet clockwise



Rotate the front feet counterclockwise if the back feet are already at their maximum height.

STEP 4 Use Your Remote

BUTTONS ON YOUR LASER CINEMA REMOTE

BUTTON	DESCRIPTION
	Power on/ Standby
INPUT	Select input sources
	Special function buttons
	Playpad keys
	Press to enter Menu
	D-pad (up/down/left/right navigation buttons)
OK	Confirmation button
	Under the Menu or App, return to the previous place
	Display the Home screen
VOL	Volume (up/down)
	Brightness (up/down)
	Mute and restore sound
EXIT	Exit the menu or exit the application
	Activate the microphone
	Custom button to launch input or apps quickly

APP	Quick access buttons to APP
	Input numbers

NOTE: Buttons listed here are for reference only. Actual remote control may vary depending on model, country/region.

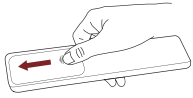

1. Slide the back cover to open the battery compartment of the remote control.

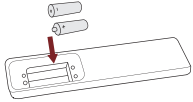

2. Insert two AA or AAA size batteries. Make sure to match the (+) and (-) ends of the batteries with the (+) and (-) ends indicated in the battery compartment.

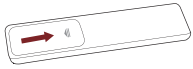

3. Close the battery compartment with the cover.

IMPORTANT INFORMATION ABOUT THE REMOTE AND BATTERIES

- Discard batteries in a designated disposal area. Do not throw them into a fire.
- Remove old batteries immediately to prevent them from leaking into the battery compartment.
- If you do not intend to use the remote control for a long time, then remove the batteries.
- Battery chemicals can cause a rash. If the batteries leak, clean the battery compartment with a cloth. If chemicals touch your skin then wash it immediately.
- Do not mix old and new batteries.
- Do not mix alkaline, standard (carbon-zinc) or rechargeable (NiCd, NiMH, etc.) batteries.
- Do not continue using the remote if it gets warm or hot.
- Call our Support Center immediately on the support website.

REMOTE CONTROL RANGE INFORMATION

- The remote control can work at a distance of up to 8 metres in front of the Laser Cinema. (This distance is used by infrared means in an unpaired state.)
- The remote control angle: taking the remote sensor as an apex, 6 metres away, its controlled horizontal angle is within $\pm 30^\circ$, while the vertical angle is within $\pm 15^\circ$. (This angle is used by infrared means in an unpaired state.)

PAIRING THE REMOTE CONTROL (ONLY FOR BLUETOOTH REMOTE CONTROL)

Pair the remote to the Laser Cinema after you power it on. Keep the remote control within 3 metres from the Laser Cinema. Press any button (except power and mic button) to pair.

NOTE:

- In special cases, press and hold [] button to pair.
- If an unknown error occurred with the remote, then it could have been caused by interference. Try to remove what's causing the interference and pair it again.
- If an unknown error occurred in the remote control while the battery power is normal, you can take out the batteries, press any key for 1~2 seconds, and insert them back. Then the remote control will work normally.
- The remote cannot be paired to the Laser Cinema while the Laser Cinema is in standby mode.

STEP 5 Proceed through the Screen Setup Menu

PROJECTION MODE

If you need to flip the image over top-to-bottom and/or left-to-right, select the Projection Mode.

AUTO GEOMETRIC CORRECTION

NOTE: ensure that Laser Cinema and your mobile device are connected to the same wireless network before starting correction.

1. Adjust the Laser Cinema position by using the levelling feet as needed, and ensure the frame of the screen is located inside the rectangular border.



2. Click Next to continue.
3. Scan the QR Code with your mobile device to begin Automatic Geometric Correction. After a few moments, an alignment grid pattern will appear on the screen.

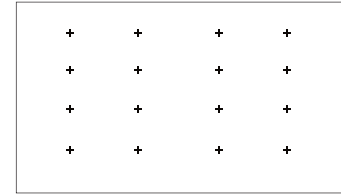

Alignment grid

4. Click "+" on your mobile device to take a photo of the full screen. For best results, stand about 10 feet away from the screen and use landscape mode.
5. Click "upload" on your mobile device to complete the Automatic Geometric Correction.

NOTE:

- Stand in front of the screen to take the photo, no deviation of more than 25° permitted.
- The whole screen should be fully visible on the photo, including the frame of the screen.
- All the 16 points in the alignment grid should be all in focus when taking the photo and visible on the photo used for correction.
- The screen image should take up at least 60% of the overall photo size.

MANUAL GEOMETRIC CORRECTION

Select points and move it to fit the projected image into the screen.

1. Press **^ / v / < / >** buttons on your remote control to move focus, and press **OK** button to choose a point you need to adjust.
2. Long press **^ / v / < / >** buttons: quick adjustment of the projected image;
Short press **^ / v / < / >** buttons: precise adjustment of the projected image.
3. Press **↵** button to save your adjustment, and you can select other points to adjust the image.

If you want to return the image position to the factory default, select Reset on the screen.

EYE PROTECTION

In order to protect your eyes, keep the Eye Protection on, and do not look into the lens. If you get too close to the Laser Cinema, the light output will be temporarily disabled after 5 seconds.

FOCUS ADJUSTMENT

You can adjust the focus parameters by pressing the up and down buttons on the remote. The focus effect is adjusted in real time according to the displayed background image card.

Maintenance

- Do not touch this device when it is running or just turned off because it may be hot.
- Do not wipe this device with oil because it may deteriorate the exterior or damage the paint. Contact with rubber or ethylene products for a long time may cause stains on this device.
- If the outside of the Laser Cinema is dirty, turn off the Laser Cinema and wipe with a damp soft cloth.
- Do not touch the lens with your hands.
- Do not touch or wipe the lens with ordinary cleaning cloth. Use a dust blower to remove the dust on the lens. Grease, dirt and fingerprints should be cleaned carefully by the professional by using optical cleaning cloth, lens wiping paper or professional cleaning solutions to avoid destroying the optical filming and affecting the image quality.
- To turn off this device, press the Power button on the remote control. Do not cut off the power directly when the device is working.

Quick Problem-Solving Tips

When you experience an issue with your Laser Cinema, turn it off and on again. If this does not resolve the problem, then refer to the tips below.

When I turn on my Laser Cinema, there is a delay for a few seconds before the picture appears. Is this normal?

Yes, this is normal. The Laser Cinema is initializing and searching for previous setting information.

No sound or picture

1. Check if the power cord is plugged into a powered AC outlet.
2. Press the  Power button on the remote control to activate the unit from 'Standby' mode.
3. Check to see if the LED light is on or not. If it is, then the Laser Cinema is receiving power.

I have connected an external source to my Laser Cinema and I get no picture and/or sound

1. Check for the correct output connection on the external source and for the correct input connection on the Laser Cinema.
2. Make sure you have made the correct selection for the input mode for the incoming signal.

The picture is normal but there is no sound

1. Check the volume settings.
2. Check if 'Mute' mode is set to On.

Sound but no picture or black and white picture

1. If the picture is black and white, unplug the Laser Cinema from the AC outlet and replug it after 60 seconds.

2. Check that the Colour Saturation is set to 50 or higher.
3. Try different channels.

The sound and/or picture is distorted or appears wavy

1. An electric appliance may be affecting the Laser Cinema. Turn off any appliances that are nearby and move it farther away from the Laser Cinema.
2. Insert the power plug of the Laser Cinema set into another power outlet.

The plastic cabinet makes a "clicking" type of sound

The 'click' sound can occur when the temperature of the Laser Cinema changes. This change causes the Laser Cinema cabinet to expand or contract, which makes the sound. This is normal and the Laser Cinema is OK.

The remote control does not work

1. Confirm that Laser Cinema still has power and is operational.
2. Change the batteries in the remote control.
3. Check if the batteries are correctly installed.

Product Specifications

Model Name	Laser Cinema	
Dimension (W × H × D)	20.9 × 4.7 × 13.2 inches (531 × 120 × 335 mm)	
Weight	18.7 lbs (8.5 kg)	
Active Screen Size (Diagonal)	80 ~ 120 inches	
Screen resolution	3840 × 2160	
Audio power	2 × 15 W	
Power consumption	300 W	
Power supply	120-240V ~ 50/60Hz	
Wireless LAN Module specifications	Frequency Range	2.4-2.4835GHz 5.15-5.85GHz
	Output Power (Max.)	2.4-2.4835GHz 17dBm 5.15-5.25GHz 14dBm 5.25-5.35GHz(DFS Band) 14dBm 5.49-5.71GHz(DFS/TPC Band) 14dBm 5.725-5.85GHz(for Non EU) 14dBm

Bluetooth Module specifications	Frequency Range	2.4-2.4835GHz
	Output Power (Max.)	2.4-2.4835GHz, Class1, 6dBm
Environmental conditions		Temperature: 41°F - 104°F (5°C - 40°C) Humidity: 20% - 80% RH Atmospheric pressure: 86 kPa - 106 kPa
HDMI Input		RGB / 60Hz (640×480, 800×600, 1024×768) YUV / 60Hz (480i, 480p, 720p, 1080i, 1080p) YUV / 50Hz (576i, 720p, 1080i, 1080p) 3840×2160 / 24Hz, 3840×2160 / 25Hz, 3840×2160 / 30Hz 3840×2160 / 50Hz, 3840×2160 / 60Hz
Network Standby Power Consumption		≤ 2.0 W
Power Consumption in Standby Mode		≤ 0.5 W
WIFI		IEEE802.11 a/b/g/n/ac
Bluetooth		BT5.0

Disclaimer: All products, product specifications, and data are subject to change without notice to improve reliability, function, design or otherwise.

Recycling / Licenses

WEEE (Waste Electronic Electric Equipment) European Directive 2012/19/EU



This symbol on the product or on its packaging indicates that this product must not be disposed of with your household waste. Instead, it is your responsibility to dispose of your waste equipment by handing it over to a designated collection point for the recycling of waste electrical and electronic equipment. The separate collection and recycling of your waste equipment at the time of disposal will help to conserve natural resources and ensure that it is recycled in a manner that protects human health and the environment. For more information about where you can drop off your waste equipment for recycling, please contact your local city office, your household waste disposal service or the shop where you purchased the product.

Batteries



In accordance with the Battery Directive, used batteries should not be disposed of in the domestic waste. Dispose your batteries in the collection containers specific for this purpose in retail stores.

ROHS (Restriction of Hazardous Substance) European Directive 2011/65/EU



This European directive limits the use of dangerous and hazardous substances which are difficult to recycle.

This allows recycling easily the EEE and contributes to the safeguard of the environment.

Substances included in this product match to the RoHS directive.



The terms HDMI and HDMI High-Definition Multimedia Interface, and the HDMI Logo are trademarks or registered trademarks of HDMI Licensing Administrator, Inc. in the United States and other countries.



Dolby, Dolby Vision, Dolby Atmos, and the double-D symbol are registered trademarks of Dolby Laboratories Licensing Corporation. Manufactured under license from Dolby Laboratories. Confidential unpublished works. Copyright © 2012–2022 Dolby Laboratories. All rights reserved.

THIS PRODUCT IS LICENSED UNDER THE AVC PATENT PORTFOLIO LICENSE FOR THE PERSONAL USE OF A CONSUMER OR OTHER USES IN WHICH IT DOES NOT RECEIVE REMUNERATION TO (i) ENCODE VIDEO IN COMPLIANCE WITH THE AVC STANDARD ("AVC VIDEO") AND/OR (ii) DECODE AVC VIDEO THAT WAS ENCODED BY A CONSUMER ENGAGED IN A PERSONAL ACTIVITY AND/OR WAS OBTAINED FROM A VIDEO PROVIDER LICENSED TO PROVIDE AVC VIDEO. NO LICENSE IS GRANTED OR SHALL BE IMPLIED FOR ANY OTHER USE. ADDITIONAL INFORMATION MAY BE OBTAINED FROM MPEG LA, L.L.C. SEE [HTTP://WWW.MPEGLA.COM](http://www.mpegla.com)

SIMPLIFIED EU DECLARATION OF CONFORMITY

Hereby, Hisense Visual Technology Co., Ltd. declares that the radio equipment type [PL1SE / PL1TUKSE / PL1CHSE / PL1A / PL1TUKA / PL1CHA / PL1C / PL1TUKC / PL1CHC / ERF3E96H] is in compliance with Directive 2014/53/EU. The full text of the EU declaration of conformity is available at the following internet address: <https://global.hisense.com/support/certificate-download/>.

For Great Britain:

SIMPLIFIED UK DECLARATION OF CONFORMITY

Hereby, Hisense Visual Technology Co., Ltd. declares that the radio equipment type [PL1SE / PL1TUKSE / PL1CHSE / PL1A / PL1TUKA / PL1CHA / PL1C / PL1TUKC / PL1CHC / ERF3E96H] is in compliance with Radio Equipment Regulations 2017. The full text of the UK declaration of conformity is available at the following internet address: <https://global.hisense.com/support/certificate-download/>.

ES-A2250Z1-1

