

Hisense

DRYER User manual

DHQA902UT

(2312662)X08061785B

Please read these instructions carefully.
Please keep these instructions properly for future reference.

Thank you very much for choosing our products.

- Please install and use this product correctly.
- The pictures in the manual are schematic diagrams, and the appearance and printing shall be subject to the actual products.
- The product subject to technical changes without prior notice for overall performance improvement.
- This dryer is intended solely for household use. Please do not use it to dry clothes that are not suitable for machine wash.

The symbols used in this manual are as follows:



Warning

It is used for matters related to safety and may cause personal injury.



Warning

Risk of fire /Flammable materials



Read the instructions.

Contents

1. Safety information	
Safety information.....	02
2. Product and Accessories	
Name of parts.....	12
Attached accessories.....	12
3. Installation Method	
Precautions before installation.....	13
Adjustable foot.....	13
Installation of the drain pipe.....	14
Drying rack.....	14
Power supply connection.....	15
Stacked installation.....	15
4. Drying Instructions	
Tips for clothes drying.....	16
Preparation before clothes drying.....	16
Sorting the clothes.....	17
5. Method of Use	
Control panel and functions.....	18
Program guide.....	20
6. Maintenance	
Exterior of the dryer.....	22
Door seal.....	22
Cleaning of lint and debris filter screen.....	22
Cleaning of water box.....	23
Cleaning of heat exchanger.....	23
7. Troubleshooting	
Troubleshooting.....	25
Information codes.....	27
8. Disposal	
Disposal.....	27
9. Technical data	
Technical data.....	28
10. Typical consumption table	
Typical consumption table.....	29
11. Machine parameters	
Machine parameters.....	30

1.Safety information

- ◇ Carefully read the instructions for use before using the dryer.
- ◇ Please, do not use the dryer without reading and understanding these instructions for use first.
- ◇ These instructions for use of a dryer are supplied with different types or models of dryers. Therefore, they may include descriptions of settings or equipment that are not available in your dryer.
- ◇ Failure to observe the instructions for use or inappropriate use of the dryer may result in damage to the laundry or the appliance, or injury to the user. Keep the instruction manual handy, near the dryer.
- ◇ Your dryer is intended solely for household use. If the dryer is used for professional, for-profit purpose or purpose exceeding normal use in a household, or if the dryer is used by a person who is not a consumer, the warranty period shall be equal to the shortest warranty period required by relevant legislation.
- ◇ The dryer is made in compliance with all relevant safety standards.

WARNING:

To reduce the risk of explosion, fire, death, electric shock, injury or scalding to persons when using this product, follow basic precautions, including the following.

Installation

- Follow the instructions for correct installation of the Hisense dryer and connection to the power mains.
- For appliances with ventilation openings in the base, a carpet must not obstruct the openings.
- The appliance must not be installed behind a lockable door, a sliding door or door with a hinge on the opposite side to that of the tumble dryer, in such a way that a full opening of the tumble dryer door is restricted.
- All and any repairs or maintenance tasks on the dryer should only be done by trained experts. Unprofessional repair may result in an accident or major malfunction.
- To avoid danger, a damaged power cord may only be replaced by the manufacturer, a service technician, or an authorized person.
- After installation, the dryer should stand still for two hours before it is connected to the power mains.
- At least two persons are required to install the tumble dryer on top of a washing machine.
- Install the dryer in a room with adequate ventilation and a temperature between 10°C and 25°C.
- Always use the ducts or hoses supplied with the dryer.
- Place the dryer on a level and stable solid (concrete) base.
- Do not place the dryer behind lockable or sliding door, or door with a hinge on the opposite side of the dryer door hinge. Install the dryer in such way that the door can always be freely opened.

- Never block the air exhaust (evacuation opening).
- Do not place the dryer on a carpet with long fibres as this may impede air circulation.
- Air in the dryer environment should not contain dust particles.
- The appliance may not be in contact with a wall or adjacent furniture.
- This appliance must not be stored or used in any outdoor location.
- That adequate ventilation has to be provided to avoid the back flow of gases into the room from appliances burning other fuels, including open fires.

Electrical safety

- If the supply cord is damaged, it must be replaced by the manufacturer, its service agent or similarly qualified persons in order to avoid a hazard.
- The dryer may not be connected to the power mains using an extension cord.
- Do not connect the tumble dryer to an electrical outlet intended for an electric shaver or a hair dryer.
- The dryer is protected with an automatic switch-off system in case of overheating. This system will switch off the dryer if the temperature is too high.
- If the net filter is clogged, the overheating automatic switch-off system may be activated. Clean the filter, wait for the dryer to cool down, and try running it again. If the dryer still fails to start, call a service technician.

- Do not use multiple outlet sockets, an extension power cable or double adapter with this appliance.
- This appliance must be earthed via the power cord. In the event of malfunction or breakdown, grounding will reduce the risk of electric shock by providing a path of least resistance for electric current.
- Improper connection of the equipment-grounding conductor can result in risk of electric shock. Check with a qualified electrician or service personnel if you are in doubt as to whether the appliance is properly grounded.
- This appliance is equipped with a power cord having an equipment-grounding earthing pin and a grounding power plug. The power plug must be plugged into an appropriate outlet socket that is installed and grounded in accordance with all local codes and ordinances.
- Never unplug the appliance by pulling on the power cable. Always grip the power plug firmly and pull straight out from the outlet socket.
- Do not spray water inside or outside the appliance to clean it.

WARNING:

- The appliance must not be supplied through an external switching device, such as a timer, or connected to a circuit that is regularly switched on and off by a utility.
- There is a risk of electric shock as the dryer is operated with electricity .
- Check the dryer for visible damage .
- You must not operate the dryer if it is damaged .

- Before connecting the dryer to the power supply , ensure that the electric voltage specified on the rating plate matches the voltage of your socket .
- Only use residual current circuit breakers with the following symbol.
- Ensure that the mains cable is not kinked or trapped , and it does not come into contact with heat sources or sharp edges .

Children safety

- This appliance is not intended for use by persons (including children) with reduced physical, sensory or mental capabilities, or lack of experience and knowledge, unless they have been given supervision or instruction concerning use of the appliance by a person responsible for their safety.
- Children should be supervised to ensure that they do not play with the appliance.
- This appliance can be used by children aged from 8 years and above and persons with reduced physical, sensory or mental capabilities or lack of experience and knowledge if they have been given supervision or instruction concerning use of the appliance in a safe way and understand the hazards involved. Children shall not play with the appliance. Cleaning and user maintenance shall not be made by children without supervision.
- Children of less than 3 years should be kept away unless continuously supervised.
- Prevent your children and pets from entering the dryer drum.
- Before closing the dryer door and running the programme, make sure there is nothing except laundry in the drum (e.g. if a child climbed into the dryer drum and closed the door from the inside).
- Do not leave the appliance door open. Children may hang on the door or crawl inside the appliance, causing damage or injury.

Use

- The tumble dryer is not to be used if industrial chemicals have been used for cleaning.
- The lint trap has to be cleaned frequently.
- Do not dry unwashed items in the tumble dryer.
- Items that have been soiled with substances such as cooking oil, acetone, alcohol, petrol, kerosene, spot removers, turpentine, waxes and wax removers should be washed in hot water with an extra amount of detergent before being dried in the tumble dryer.
- Items such as foam rubber (latex foam), shower caps, waterproof textiles, rubber backed articles and clothes or pillows fitted with foam rubber pads should not be dried in the tumble dryer.
- Fabric softeners, or similar products, should be used as specified by the fabric softener instructions.
- Remove all objects from pockets such as lighters and matches.
- Oil-affected items can ignite spontaneously, especially when exposed to heat sources such as in a tumble dryer. The items become warm, causing an oxidation reaction in the oil. Oxidation creates heat. If the heat cannot escape, the items can become hot enough to catch fire. Piling, stacking or storing oil-affected items can prevent heat from escaping and so create a fire hazard.
- If it is unavoidable that fabrics that contain vegetable or cooking oil or have been contaminated by hair care products be placed in a tumble dryer they should first be washed in hot water with extra detergent - this will reduce, but not eliminate, the hazard.
- In case of a defect, only use approved spare parts by authorized manufacturers.

- If the condensate tube is blocked or clogged, then tumble dryer operation is stopped.
- Before moving the dryer or before storing it in a non-heated room during the winter, the condensate tank has to be emptied.
- Clean the dryer filters after each drying cycle. If you have removed the filters, replace them before the next drying cycle.
- Do not use any solvents or cleaning agents that could damage the dryer (please observe the recommendations and warnings provided by the manufacturers of the cleaning agents).
- Never add chemicals or fragrances into the condensate tank.
- After the drying process, unplug the dryer power cord from the power outlet.
- The dryer uses a heat pump system to heat the air.
- The system consists of a compressor and a heat exchanger. When the dryer is started, compressor operation (the sound of flowing liquid) or flow of refrigerant may be louder as long as the compressor operates. This is not a sign of malfunction and it will not affect useful life of the dryer. In time and with use of the dryer this noise will become quieter.
- Do not drink or prepare food with the condensed water/distilled water. It can cause health problems to people and pets.
- Remove clothes from the product immediately when drying is complete or the power is turned off during the drying process. Leaving clothes that has been dried in the appliance unattended could result in fire. Clothes not removed from the appliance after drying could result in fire. Remove clothes immediately after drying, and then hang or lay the clothes flat to cool.
- Never attempt to operate the appliance if it is damaged, malfunctioning, partially disassembled, or has missing or broken parts, including a damaged cord or plug.
- Do not attempt to separate any panels or disassemble the appliance. Do not apply any sharp objects to the control panel in order to operate the appliance.
- Never reach into the appliance while it is operating. Wait until the drum has completely stopped.
- In case of flood, disconnect the power plug and contact the After-sales Service Center.
- Do not push down on the door, when the appliance door is open.
- Do not touch the power plug or the appliance controls with wet hands.
- Do not bend the power cable excessively or place a heavy object on it.
- Lint must not be allowed to accumulate around the tumble dryer.
- Keep the area underneath and around the appliance free of combustible materials such as fibres, paper, rags, chemicals, etc.
- As the dryer is heavy , you could injure yourself by trying to lift it . Do not lift the dryer on your own .
- You could cut your hands on the sharp edges of the dryer . Do not hold the dryer by the sharp edges .
- Protruding parts on the dryer may break off when it is lifted or pushed .
- Do not move the dryer by holding onto protruding parts .

- Check the dryer for damage caused during transportation . Never operate a dryer if it is damaged .
- Any residual water in the dryer may freeze and damage the dryer .
- Do not install the dryer in rooms that are at risk of frost .

The appliance contains refrigerant which although it is environmentally friendly, is flammable R290. Failure to dispose of it properly may result in a fire or poisoning. Dispose of the appliance properly and do not damage the pipes in the refrigerant circuit.

 **WARNING:**

Never stop a tumble dryer before the end of the drying cycle unless all items are quickly removed and spread out so that the heat is dissipated.

 **WARNING:**

In the appliance enclosure or in the built-in structure, keep ventilation openings clear of obstruction.

 **WARNING:**

Do not damage the refrigerant circuit.

Maximum Capacity

The maximum capacity of dry textile material to be used in the appliance is:

DHQA902UT
9kg

Danger of hot surface

- At higher drying temperatures, the door glass will heat up. Be careful to avoid burns. Make sure children do not play near the door glass.
- The back of the dryer may get very hot during operation. Wait for the dryer to cool down completely before touching its back side.
- If you open the dryer door during the drying process, the clothes may be very hot and there is a risk of burning.

Service

- In case of incorrect dryer connection, incorrect use, or servicing by an unauthorized person, the user shall bear the cost of any damage as such damage shall not be covered by warranty.
- The warranty does not cover consumables, minor deviations in colour, increased noise that results from appliance age and which does not affect the functionality of the dryer, and aesthetic defects on components, which do not affect the dryer's functionality and safety.

2. Product and Accessories

Name of parts

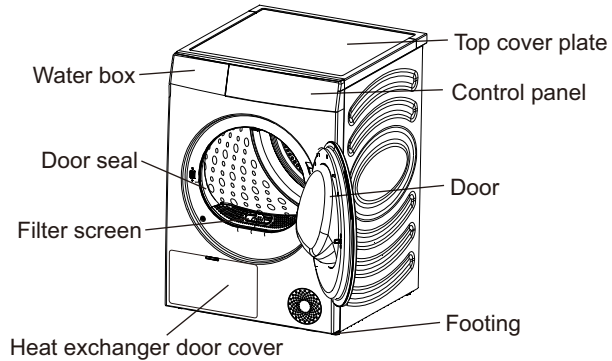

Attached accessories



Instructions × 1

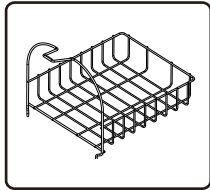

Drying rack × 1

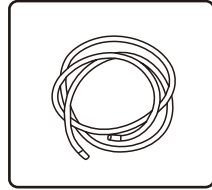

Drain pipe × 1

3. Installation Method

The clothes dryer must be properly installed by qualified professionals to ensure use safety. The user shall be responsible for the service caused by poor and incorrect installation.

1). Precautions before installation

Installation environment

- ◇ It is recommended to installed in an embedded space, please reserve the minimum installation clearance for the dryer: 25 mm at the top, 20 mm at the left and right sides and 50 mm at the back.

Installation requirements

- ◇ Please install the dryer in a dry and well ventilated place with flat and solid ground. Do not place it on carpet, cardboard, or place with direct sunlight.
- ◇ The working environment temperature of the dryer is 5°C-35°C. Do not place it below 0°C or at a high temperature. The appliance performs best at a room temperature of 23 °C.
- ◇ During handling, the inclination angle of the dryer shall not exceed 45°; after handling, it needs to stand for more than 2 hours.
- ◇ The dryer shall not be placed next to the oven, stove and other high-temperature equipment, nor next to the refrigeration equipment. The back of the dryer must be well ventilated.
- ◇ It is recommended that the clothes dryer and washing machine be placed close to each other to facilitate clothes dehydration after washing dehydration.
- ◇ Install the appliance on a flat hard floor. Allowable slope under the appliance is 1 degree.

2). Adjustable foot

- ◇ Press the diagonal on the top of the dryer to confirm whether the dryer is in a stable state.
- ◇ If the dryer shakes, rotate the four adjustable feet at the bottom to adjust them to the appropriate height to ensure that the dryer is in a stable state.
- ◇ Never try to correct any unevenness in the floor with pieces of wood, cardboard or similar materials under the appliance.

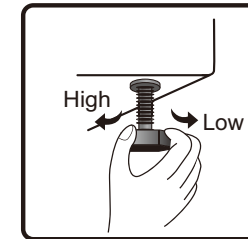
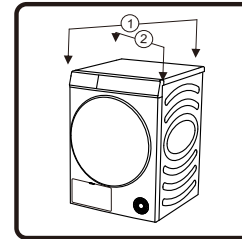

3). Installation of the drain pipe

Usually, the condensate water after drying is stored in the water box, and the water box needs to be emptied after each program. If the installation position of the dryer is close to the sewer, or the clothes dryer is stacked on the washing machine, the attached drain pipe can be installed to discharge the water directly to the sewer.

- ◇ Remove the connecting pipe at the rear of the water box, and install the drain pipe among the attached accessories to this position (as shown in the figure). Please confirm that the installation connector is firmly connected.

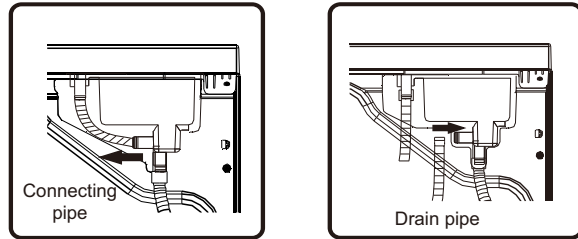

- ◇ Please insert the other end of the drain pipe into the floor drain without twisting or flattening. If the pipe is too long, please cut off the excess part.
- ◇ The drain pipe shall not be higher than the dryer, otherwise the water cannot be drained.
- ◇ Do not place the drain in accumulated water, which may cause backsuction.
- ◇ After the drain pipe is installed in place, the condensate water can be discharged directly without emptying the water box after each use.

4). Drying rack

- ◇ When drying shoes and plush toys, etc., or selecting rack dry, the drying rack can be used.
- ◇ When drying clothes, please take out the drying rack.
- ◇ Installation of drying rack: Please tilt the drying rack to a certain angle with the lower end clamped in the two holes of the filter screen and the upper end hooked in the slot of the front support.

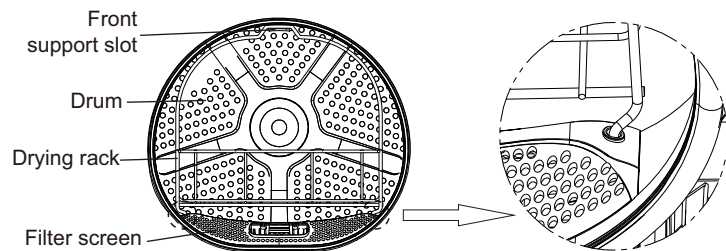

5). Power supply connection

- ◇ Ensure that the power supply is consistent with the power requirements of the dryer.
- ◇ The dryer must be grounded reliably.
- ◇ Do not use a power strip or multi-purpose socket for secondary connection.

NOTE

- Always unplug the appliance after use.

6). Stacked installation

- ◇ The dryer can be stacked with a Hisense washing machine with 486mm side plate of the box.
- ◇ When stacking, it shall be fixed with accessories for stacking. Please contact qualified service personnel for installation.
- ◇ Without stacking accessories, the dryer and washing machine must not be stacked to avoid safety accidents.
- ◇ For safety reasons, two or more people need to work together to install. The weight of the appliance and the height of the installation makes the installation procedure too risky for one person.
- ◇ The surface on which the appliance is placed should be clean and level.
- ◇ The stack suit needs to be placed against the wall with a distance of 50-200mm.

NOTE

- Some models are not sold with all of the available accessories, you may need to purchase the stacking kit first if it was not provided with your model. Please contact Hisense After-sales Department for purchase.

Stacking bracket (optional accessories)

- ◇ The clothes dryer and washing machine can also be fixed with a stacking bracket. For the installation method, please refer to the installation instructions attached to the accessories.
- ◇ Please purchase the optional accessories from the After-sales Department.

4. Drying Instructions

1). Tips for clothes drying

- ◇ Clothes must be dehydrated before being put into the dryer. In order to save energy, please increase the dehydration speed of washing machine to above 1000 rpm.
- ◇ Please shake the dehydrated clothes up before putting them into the dryer.
- ◇ In order to achieve ideal drying effect, please classify the clothes by types and select the appropriate drying program. Each program has its maximum load requirements, and do not overload.
- ◇ After drying clothes, clean the lint and debris filter screen in time.
- ◇ When drying a small amount of clothes, it is recommended to use a timer program.
- ◇ Do not dry the starched clothes, because the hardening of the starch layer will reduce the drying effect.
- ◇ Clothes that are easy to fade should be dried separately.
- ◇ A mixed fabric load can cause the drying time to be extended and the time remaining in the display to pause during active drying. The remaining time will then continue when it is the actual time that remains.

2). Preparation before clothes drying















- ◇ Before drying, please check the clothing tab to confirm whether it is suitable for drying.
- ◇ Empty your pockets and take out coins, pins, keys and other items to avoid clothing damage.
- ◇ Zip up the zipper, button up the buttons and tighten the belt. In order to avoid the sound of zippers and buttons during drying, please turn the clothes over before putting them into the dryer.
- ◇ Check whether the water box is drained off and whether the lint and debris filter has been cleaned and installed in place.

NOTE

- The drying time of clothes will be automatically adjusted according to the following factors:
type of clothes, load of clothes, water content after dehydration, and ambient temperature.
- Please be sure to check the clothing tag to ensure that the clothes can be dried to avoid damage to the clothes.
- Drying clothes with different textures and thicknesses at the same time will have different drying effects.

3). Sorting the Clothes

- ◇ Clothes have their own fabric care labels, so drying according to the fabric care label is recommended. Sort the clothes into size and type of fabric and then prepare the clothes according to the symbols on the fabric care labels.

Symbol	Description
	Dry
	Tumble Dry
	Permanent Press / Crease Resistant
	Gentle / Delicate
	Do not Tumble Dry
	Do not Dry
	High Heating
	Medium Heating
	Low Heating
	No Heating / Air
	No Heating / Air
	Line Dry / Hang to dry
	Drip Dry
	Dry Flat
	In the Shade

5. Method of Use

1). Control panel and functions

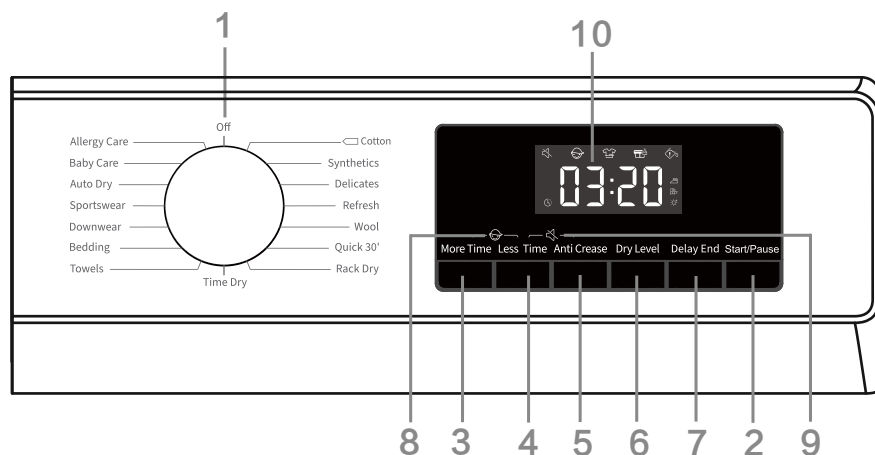

(1). Knob

- It is used to turn the power on/off. In case of shut down during operation, rotate the knob to "OFF".
- The dryer will automatically shut down after the program ends. If there is no operation within 2 minutes in the standby mode, the dryer will shut down automatically.
- It is used for program selection. Please refer to [Program guide] for program introduction.

(2). Start Pause

- Press the "Start Pause" key to pause or start the program.
- When the program is suspended, the set functions cannot be changed. If the program or function needs to be changed during operation, or the power is off during operation and the power needs to be powered on again, turn the knob to "Off", then turn the knob again to select the required program and function, and finally start it.

(3). More Time

- Before the program starts, this function can add drying time of the program. Press continuously to cycle through the set tap positions. Different programs have different tap position settings.

(4). Less Time

- Before the program starts, this function can reduce drying time of the program. Press continuously to cycle through the set tap positions. Different programs have different tap position settings.

(5). Anti crease

- If the clothes cannot be taken out in time after drying, select the anti crease program. At this time, the inner drum rotates intermittently to prevent clothes from creasing.
- Touch any key or open the door to exit the anti crease mode. If there is no operation, the longest execution will end automatically after 12 h by default.

(6). Dry level

- For selection of drying effect. The default option is [], and press the dry level key to select.

[] means the clothes can be stored after drying.

[] means the clothes has a small amount of water and can be ironed.

[] means the clothes can be worn immediately after drying.

(7). Delay End

This function can delay the end time of the program.

- Make an appointment after selecting programs and functions. Press the appointment button to add or reduce the appointment time. The time changes by 1 hour for each press, and the maximum optional time is 24 hours.
- The appointment time is the end time of the program, including the running time of the whole program, so the appointment time must be longer than the running time of the program.
- During the appointment process, the appointment icon is lit up. After the appointment process ends, the appointment text goes out.
- Before the program starts, the selected appointment can be canceled by selecting other programs or function keys.
- After the program is started, in case of canceling the appointment, shut down and restart the dryer.

(8). Child Lock

In order to avoid children's misoperation and protect children's safety, this dryer is equipped with child lock.

- After the program is started, press and hold "More Time+Less Time" simultaneously, the child lock will be enabled and the child lock icon will be lit up. The child lock can be released by the same operation.
- After the child lock function is set, other function keys are locked. In case of program ends or restart after power-off, the child lock function set remains.
- After the child lock function is enabled: Press the "Start Pause" key to cancel the prompt in case of prompt for lint and debris cleaning. During running in anti crease mode, the child lock needs to be released manually, and the anti crease function ends automatically.





(9). Mute

- It is used to turn on/off the beep, except the alarm tone.
- After standby or startup, press and hold "Less Time+Anti Crease" key to turn on/off the mute function.
- The mute function will not be released automatically in case of end of program or power-off.

(10). Display

- It is used to display the remaining time, appointment time, fault code and other information of the program.
- The time displayed by the program may be different from the actual running time. Due to the influence of type of clothes, load of clothes, water content after dehydration, and ambient temperature, the actual drying time will be automatically adjusted.
- When the program ends, "End" will be displayed.

Icon description

	Appointment icon. When the icon is lit up, it indicates that the appointment function is enabled.
	Anti crease icon. When the icon is lit up, it indicates that the anti crease function is enabled.
	Lint and debris cleaning icon. The flashing icon indicates that the lint and debris needs to be cleaned.
	Water box cleaning icon. The flashing icon indicates that the water box needs to be emptied.

(11). Other functions

Drum light

- This dryer is equipped with a drum light. In the states of standby, operation (rotate the knob, press any key or open the door), pause, and program ends, the drum light will automatically illuminate for 1 minute and then turn off automatically, so that the drum interior can be seen.

Stop when the clothes are dry

- This dryer stops when the clothes are dry. When the load of clothes is small, it is likely that the program is not completed but the clothes have been dried, at this time, the program will end automatically to save energy.

2). Program guide

NOTE

- Users can choose the appropriate program according to their habits. If the clothes are not completely dried, additional drying of timer program can be selected.
- When drying large fabrics such as bed sheets and quilt covers, due to large load, they may be wrapped into clusters, affecting the drying effect. Please take them out and shake them up before putting them into the dryer to continue drying.
- When drying down clothes, please turn out the inner side of the clothes before drying.

Sensor dry programs

Programs	Type of clothes	Maximum capacity (kg)
		DHQA902UT
 cotton	Use this programme for thicker non-sensitive cotton laundry of approximately the same thickness. After drying, it will be dry.	9
synthetics	The programme is used for drying delicate laundry made of synthetics fibres.	4.5
Delicates	Use this programme to dry highly delicate laundry made of synthetic fibres, which may be slightly moist after the drying process. We recommend using a special-purpose laundry bag.	1
Towels	Use this programme for drying non-sensitive items (towels, kitchen cloths...). After drying, the items will be dry and ready to be stored in the cupboard.	4
Bedding	Use the programme for larger items. When the programme is complete, they will be dry. Adjusted drum rotation prevents the laundry from tangling.	2.5
Downwear	Use this programme to dry textiles stuffed or padded with down (pillows, duvets, jackets etc.). Dry large items separately and use the Extra Dry function or the Time Programme if necessary.	2
Sportswear	Use this programme for clothing with a membrane, for sportswear made of mixed materials, and breathable fabrics..	2
Auto Dry	Use this program for thicker non-sensitive cotton laundry of approximately the same thickness. After drying, it will be dry or slightly moist.	4.5
Baby Care	Use this programme to dry baby clothes. Clothes dried with this programme are usually normally dry.	2
Allergy Care	For removing allergens such as mites.	2
Quick'30	For quick drying of light and thin clothes.	0.5

* EN 61121 test program setting.

* These programs have reversing function specially for big load

Manual and special dry programs

Programs	Type of clothes	Maximum capacity (kg)
		DHQA902UT
Refresh	In this programme, the heater is switched off. The programme is suitable for refreshing your laundry.	/
Wool	This short program is intended for softening or fluffing of clothes made of wool and silk, which have to be dried thoroughly according to manufacturer's instructions.	1
Rack Dry	When using this program, you can place the load to be dried (e.g., small stuffed animals, sneakers, etc.) on the drying rack for drying.	/
Time Dry	Use this programme for non-sensitive laundry that is still slightly moist and has to be thoroughly dried. In the time programme, remaining moisture is not detected automatically. If the laundry is still damp after the programme is complete, repeat the programme; if it is too dry and therefore creased and rough to touch, the drying time you selected was too long.	/

6. Maintenance

Regular maintenance can prolong the service life of the dryer. Be sure to cut off the power supply before maintenance.

1). Exterior of the dryer

- ◇ Clean with a soft wet cloth and wipe the body surface with a non-corrosive household cleaner.
- ◇ Then, dry it with a soft dry cloth.

2). Door seal

- ◇ Check the door seal regularly and clean it with wet cloth if necessary.
- ◇ After use, open the door slightly for ventilation and drying.

3). Clean the lint and debris filter screen

- ◇ Excessive fluff accumulated on the filter screen will affect the drying effect. Please clean the filter screen after each use.
- ◇ After cleaning, be sure to reinstall the filter screen in place before use.

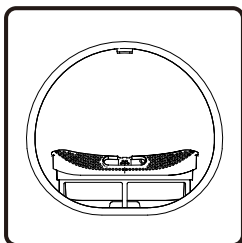

1. Open the door and take out the filter screen from the front support.

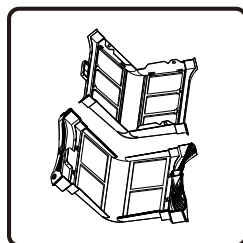

2. Open the filter screen and clean the fluff of the two-layer filter screen with a wet towel or flowing water.

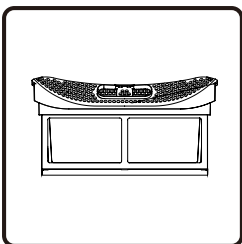

3. After drying the filter screen, reassemble it.

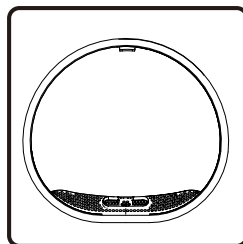

4. Install the filter screen to the front support.

Notes:

- There is a temperature sensor at the bottom of the front support. After the lint and debris filter screen is taken out, please be careful not to touch it to avoid scratching.
- When reinstalling the filter screen, install in the correct direction and at the correct position.
- Do not use this dryer when the filter screen is not installed correctly.

4). Cleaning of water box

- ◇ If the drain pipe is not installed, the condensate water after drying is stored in the water box. Please drain off it in time after program ends.
- ◇ During running, if the water box is full,  on the display flashes for prompt, please empty the water box immediately.
- ◇ The condensate water is not edible.

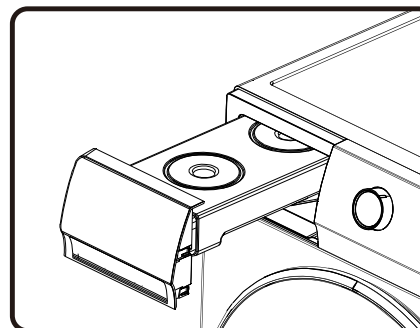

1. Take out the water box horizontally to avoid spillover of condensate water.

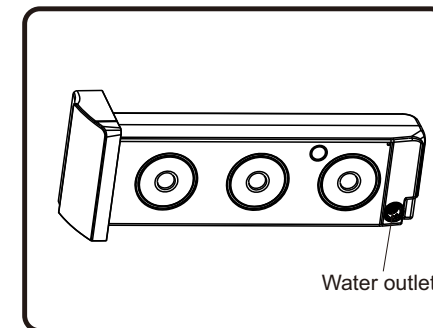

2. Dump the condensate water and reinstall the water box in place.

5). Cleaning of heat exchanger

- ◇ Please clean the heat exchanger regularly, otherwise the performance of the dryer will be affected.

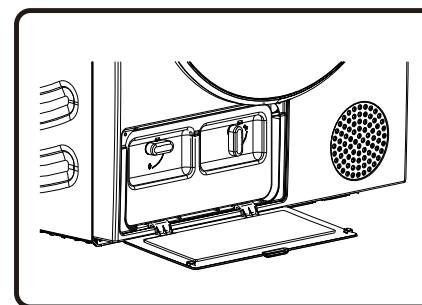

1. Press the buckle of the heat exchanger door cover at the lower left to open the door cover.

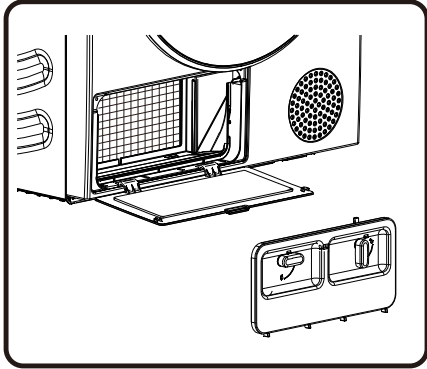

2. Turn the locking knob of the base filter cover to unlock position.

After using for a period of time, if there is dust on the heat exchanger, please remove the dust with tools. Do not touch the heat exchanger directly with your hands to avoid injury.

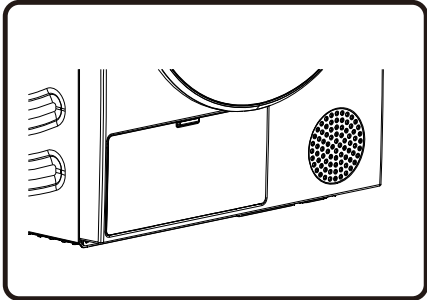

3. Install the cleaned filter and filter cover back to the original positions, lock the knob and close the heat exchanger door cover.

7. Troubleshooting

When the machine fails to operate normally, it may not be a fault. Please refer to the following methods for troubleshooting. If the fault still exists after self handling according to the recommended method, please unplug the power supply and contact us for after-sales service.

All consequences caused by the maintenance by the user himself or by hiring non-professional after-sales personnel will be borne by the user.

Fault phenomenon	Recommended handling method
The dryer cannot be started	<ul style="list-style-type: none"> ◇ Check the power connection; ◇ Confirm the "Start/Pause" key is pressed down; ◇ Confirm the door is closed properly; ◇ House fuse is blown, circuit breaker has tripped, or power outage has occurred.
The dryer cannot be started and displays "End"	<ul style="list-style-type: none"> ◇ Check whether the program setting is correct; ◇ Confirm there are clothes in the drum;
Excessive drying time	<ul style="list-style-type: none"> ◇ Check whether the program setting is correct; ◇ Confirm whether there are too many clothes wrapping into clusters; ◇ Check whether the filter screen is cleaned; ◇ There will be air supply for cooling after drying in some programs;
Poor drying effect	<ul style="list-style-type: none"> ◇ Confirm that the clothes have been dehydrated; ◇ Check whether the program setting is correct; ◇ Confirm that there are too many clothes; ◇ Load is not properly sorted. Whether clothes that are not easy to dry are mixed with clothes that are easy to dry; ◇ Large load of heavy fabrics. ◇ Check whether the filter screen is cleaned;
The remaining time of the display stops or jumps	<ul style="list-style-type: none"> ◇ The remaining time varies with clothing type, load, dehydration and ambient temperature, which is a normal phenomenon;
Clothes are wrinkled.	<ul style="list-style-type: none"> ◇ Clothes have dried too long. Try a shorter drying time. ◇ Clothes have been left in the appliance for too long after cycle ends.

Fault phenomenon	Recommended handling method
The dryer is too loud.	<ul style="list-style-type: none"> ◇ Look for coins, loose buttons, nails, and other objects and remove them immediately. ◇ Check the lint filter. Remove any items stuck inside the lint filter. ◇ Make sure the dryer is level and standing firmly on the floor. ◇ The dryer may hum due to air moving through the drum and fan. This is normal.
Clothes are shrinking.	<ul style="list-style-type: none"> ◇ Garment care instructions are not being followed. Use a low or no heat setting.
Lint is left on clothes.	<ul style="list-style-type: none"> ◇ Lint filter has not been cleaned properly. ◇ Clothes have not been sorted properly. ◇ Some fabrics cause more lint and should be dried separately from fabrics that lint attaches easily. ◇ Tissue, paper, etc., has been left in pockets.
The appliance has an odour.	<ul style="list-style-type: none"> ◇ The smell is caused by rubber material that is attached to the appliance inside. This kind of smell is a rubber's own smell and disappears automatically after using the appliance several times. ◇ When washing the clothes, use the detergent in accordance with the manufacturers recommendations. If you use the detergent excessively not according to the recommendations, undissolved detergent may accumulate on the clothes and cause an odour. ◇ You can smell odours from the clothes if the clothes were left in the appliance after drying or in the washing machine after washing. Unload the clothes promptly at the end of the drying or washing cycle. ◇ Ensure you can smell same odour in the washing machine. If so, clean the tub of the washing machine referring to the washing machine user manual. ◇ Always take care of both lint filters clean. If any residues were left in the lint filter after drying, it may cause odours. And also dry the lint filter completely after cleaning.
The machine is powered on and started directly after power failure, but does not work	<ul style="list-style-type: none"> ◇ When the program is suspended, the set functions cannot be changed. If the program or function needs to be changed during operation, or the power is off during operation and the power needs to be powered on again, turn the knob to "Off", then turn the knob again to select the required program and function, and finally start it.

Information codes

Code	Interpretation	Recommended handling method
F50/F51	Abnormal sensor	◇ Please contact after-sales service.
F21	Abnormal display panel and the power board	<ul style="list-style-type: none"> ◇ Rotate the knob to "Off" to shut down the dryer, and restart it after 10 seconds. ◇ If the abnormality is not removed, please contact after-sales service.

8. Disposal

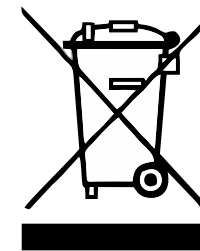

Packaging is made of environmentally friendly materials that can be recycled, disposed of, or destroyed without any hazard to the environment. To this end, packaging materials are labelled appropriately.

The symbol on the product or its packaging indicates that the product should not be treated as normal household waste. Take the product to an authorized collection centre for waste electric and electronic equipment processing.

When disposing of the dryer at the end of its useful life, remove all power cords, and destroy the door latch and switch to prevent the door from locking or latching (child safety).

Correct disposal of the product will help prevent any negative effects on the environment and health of people, which could occur in case of incorrect product removal. For detailed information on removal and processing of the product, please contact the relevant municipal body in charge of waste management, your waste disposal service, or the store where you bought the product.

9. Technical data

Trade Mark	Hisense
Model	DHQA902UT
Rated capacity (kg)	9
Air-vented or condenser tumble drier	condenser
Energy efficiency class	A++
Weighted Annual Energy Consumption (kWh) ⁽¹⁾	245.0
Automatic tumble drier or nonautomatic tumble drier Automatic	Automatic tumble dryer
Energy consumption of the standard cotton programme at full load (kWh)	1.96
Energy consumption of the standard cotton programme at partial load (kWh)	1.15
Power consumption of the off-mode (W)	0.49
Power consumption in left-on mode (W)	0.57
Duration of the left-on mode (min) ⁽²⁾	5
Standard drying programme ⁽³⁾	☐ cotton
Weighted programme time of the 'standard cotton programme at full and partial load' (min)	158
Programme time of the 'standard cotton programme at full load' (min)	209
Programme time of the 'standard cotton programme at partial load' (min)	120
Condensation efficiency class on a scale from G (least efficient) to A (most efficient)	B
Average condensation efficiency of the standard cotton programme at full load as a percentage	81
Average condensation efficiency of the standard cotton programme at partial load as a percentage	81
Weighted condensation efficiency for the 'standard cotton programme at full and partial load as a percentage.	81
Sound power level (dB) ⁽⁴⁾	65
Built-in	NO

(1) Based on 160 drying cycles of the standard cotton programme at full and partial load, and the consumption of the low-power modes. Actual energy consumption per cycle will depend on how the appliance is used.

(2) If the household tumble drier is equipped with a power management system.

(3) The 'standard cotton programme' used at full and partial load is the standard drying programme to which the information in the label and the fiche relates, this programme is suitable for drying normal wet cotton laundry and it is the most efficient programme in terms of energy consumption for cotton.

(4) For the standard cotton programme at full load.

10. Typical consumption table

The table lists the values for drying time and power consumption for drying of a test batch of laundry with various spinning rpm in the washing machine.

Program	Load	Spinning [rpm]	Electric energy consumption [kWh]	Drying time [min]
			9kg	
☐ cotton	total	1000	2.09	206
	partial	1000	1.14	125
	low	1000	1.08	120
	low	1200	1.01	112
cotton moist for ironing	total	1000	1.45	150
	partial	1000	0.95	111
	low	1000	0.82	98
synthetics	partial	1000	0.48	55

Test programme in accordance with Regulation 392/2012/EU for energy labelling, measured in accordance with EN61121.

Program	Amount of laundry Max./half load [kg]	Programme duration [min]	Electric energy consumption [kWh]
			A++
☐ cotton	9/4.5	209/120	1.96/1.15

The Cotton programme ☐, is intended for drying of normally wet cotton laundry. It is the most efficient programme for drying cotton laundry in terms of power consumption.

Due to deviations in terms of type and amount of laundry, power supply oscillation, and environment temperature and humidity, the values measured at the end user may differ from the one stated in the table.

11. Machine parameters

Product Model Parameter	DHQA902UT
Power	220-240V~ 50Hz
Rated capacity	9.0kg
Rated power	650W
Overall dimension (W × D × H)	595x685x845(mm)
Net weight	54kg
Refrigerant	R290
Charge	125g

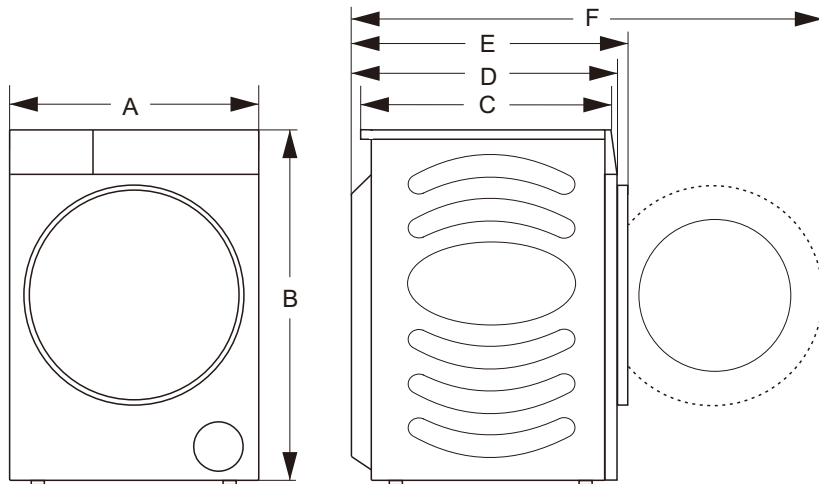

Dimensions	A	595mm
	B	845mm
	C	590mm
	D	640mm
	E	685mm
	F	1170mm