

Hisense

life reimagined

USER'S OPERATION MANUAL

Before operating this unit, please read this manual thoroughly, and retain for future reference

RF815N4SESE

EN

English

Thank you for choosing Hisense. We are sure you will find your new refrigerator a pleasure to use. However, before you use the appliance, we recommend that you carefully read the instructions, which provide details about installing and using the product. Please keep this manual for future reference.

Contents

REFRIGERATOR SAFETY.....	3
PARTS AND FEATURES.....	11
INSTALLATION REQUIREMENTS.....	12
Location Requirements.....	12
Electrical Requirements.....	12
INSTALLATION INSTRUCTIONS.....	13
Unpack the Refrigerator.....	13
Installation Positioning.....	13
Door Removal.....	13
Installing the water lines.....	16
Level Refrigerator.....	17
Align Doors.....	17
REFRIGERATOR USE.....	18
Opening and Closing Doors.....	18
Using the Controls.....	19
Features.....	23
General Use Information.....	26
REFRIGERATOR CARE.....	27
Cleaning.....	27
Lights.....	27
Vacation and Moving Care.....	28
Reinstalling/Using Refrigerator Again.....	28
TROUBLESHOOTING.....	29

Refrigerator Safety

Your safety and the safety of others are very important.

We have provided many important safety messages in this manual and on your appliance. Always read and obey all safety messages.



This is the safety alert symbol.

This symbol alerts you to potential hazards that can kill or hurt you and others. All safety messages will follow the safety alert symbol and either the word "DANGER," "WARNING" or "CAUTION."

These words mean:



DANGER

An imminently hazardous situation. You could be killed or seriously injured if you don't immediately follow instructions.



WARNING

A potentially hazardous situation which, if not avoided, could result in death or serious bodily injury.



CAUTION

A potentially hazardous situation which, if not avoided, may result in moderate or minor injury.

All safety messages will tell you what the potential hazard is, tell you how to reduce the chance of injury, and tell you what can happen if the instructions are not followed.



Safety and warning information

For your safety and correct usage, before installing and first using the appliance, read this user manual carefully, including its hints and warnings. To avoid unnecessary mistakes and accidents, it is important to make sure that all people using the appliance are thoroughly familiar with its operation and safety features. Save these instructions and be sure that they remain with the appliance if it is moved or sold, so that anyone using it throughout its life, will be properly informed on its usage and safety notices.

For the safety of life and property, keep the precautions of these user's instructions as the manufacturer is not responsible for damages caused by omission.

Safety for children and others who are vulnerable people

➤ According to EN standard

This appliance can be used by children aged from 8 years and above and persons with reduced physical, sensory or mental capabilities or lack of experience and knowledge if they have been given supervision or instruction concerning use of the appliance in a safe way and understand the hazards involved. Children shall not play with the appliance. Cleaning and user maintenance shall not be made by children without supervision. Children aged from 3 to 8 years are allowed to load and unload refrigerating appliances.

➤ According to IEC standard

This appliance is not intended for use by persons (including children) with reduced physical sensory or mental capabilities, or lack of experience and knowledge, unless they have been given supervision or instruction concerning use of the appliance by a person responsible for their safety.

- Children should be supervised to ensure that they do not play with the appliance.
- Keep all packaging away from children as there is risk of suffocation.
- If you are discarding the appliance, pull the plug out of the socket, cut the connection cable (as close to the appliance as you can) and remove the door to prevent children playing from suffering an electric shock or from closing themselves inside it.
- If this appliance, featuring a magnetic door seals, is to replace an older appliance having a spring lock (latch) on the door or lid, be sure to make the spring lock unusable before you discard the old appliance. This will prevent it from becoming a death trap for a child.



General safety

- This appliance is intended to be used in household and similar applications such as :
 - staff kitchen areas in shops, offices and other working environments;
 - farm houses and by clients in hotels, motels and other residential type environments;
 - bed and breakfast type environments;
 - catering and similar non-retail applications.
- Do not store explosive substances such as aerosol cans with a flammable propellant in this appliance.
- If the supply cord is damaged, it must be replaced by the manufacturer, its service agent or similarly qualified persons in order to avoid a hazard.
- **WARNING** — Keep ventilation openings, in the appliance enclosure or in the built-in structure, clear of obstruction.
- **WARNING** — Do not use mechanical devices or other means to accelerate the defrosting process, other than those recommended by the manufacturer.
- **WARNING** — Do not damage the refrigerant circuit.
- **WARNING** — Do not use electrical appliances inside the food storage compartments of the appliance, unless they are of the type recommended by the manufacturer.
- The refrigerant and insulation blowing gas are flammable. When disposing of the appliance, do so only at an authorized waste disposal centre. Do not expose to flame.
- **WARNING** —When positioning the appliance, ensure the supply cord is not trapped or damaged.
- **WARNING** — Connect to potable water supply only.

- **WARNING** —Do not locate multiple portable socket outlets or portable power supplies at the rear of the appliance.

Replacing the LED

- **WARNING**—The LED light must not be replaced by the user! If the LED light is damaged, contact the customer helpline for assistance.

Refrigerant

The refrigerant isobutene (R600a) is contained within the refrigerant circuit of the appliance, a natural gas with a high level of environmental compatibility, which is nevertheless flammable. During transportation and installation of the appliance, ensure that none of the components of the refrigerant circuit becomes damaged.

The refrigerant (R600a) is flammable.

- **WARNING** — Refrigerators contain refrigerant and gases in the insulation. Refrigerant and gases must be disposed of professionally as they may cause eye injuries or ignition. Ensure that tubing of the refrigerant circuit is not damaged prior to proper disposal.



Warning: Risk of fire/flammable materials

If the refrigerant circuit should be damaged:

- Avoid opening flames and sources of ignition. Thoroughly ventilate the room in which the appliance is situated.

It is dangerous to alter the specifications or modify this product in any way.

Any damage to the cord may cause a short circuit, fire, and/or electric shock.

Electrical safety

- The power cord must not be lengthened.
- Make sure that the power plug is not crushed or damaged. A crushed or damaged power plug may overheat and cause a fire.
- Make sure that you can access the main plug of the appliance.
- Do not pull the main cable.
- If the power plug socket is loose, do not insert the power plug. There is a risk of electric shock or fire.

You must not operate the appliance without the interior lighting lamp cover.

- The fridge is only applied with power supply of single phase alternating current of 220~240V/50Hz. If fluctuation of voltage in the district of user is so large that the voltage exceeds the above scope, for safety sake, be sure to apply A.C. Automatic voltage regulator of more than 350W to the fridge. The fridge must employ a special power socket instead of common one with other electric appliances. Its plug must match the socket with ground wire.

Daily use

- In order to sense the temperature and humidity near the appliance and make the appliance run better, add temperature and humidity sensors outside the box of appliance.
- Do not store flammable gas or liquids in the appliance, There is a risk of an explosion.
- Do not operate any electrical appliances in the appliance (e.g. electric ice cream makers, mixers etc.).
- When unplugging always pull the plug from the mains socket, do not pull on the cable.

- Do not place hot items near the plastic components of this appliance.
- Do not place food products directly against the air outlet on the rear wall.
- Store pre-packed frozen food in accordance with the frozen food manufacture's instructions.
- The appliances manufactures storage recommendations should be strictly adhered to.Refer to relevant instructions for storage.
- Do not place carbonated or fizzy drinks in the freeze compartment as it creates pressure on the container,which may cause it to explode,resulting in damage to the appliance.
- Frozen food can cause frost burns if consumed straight from the freezer compartment.
- Do not place the appliance in direct sunlight.
- Keep buring candles,lamps and other items with naked flames away from the appliance so that do not set the appliance on fire.
- The appliance is intended for keeping food stuff and/ or beverages in normal household as explained in this instruction booklet The appliance is heavy.Care should be taken when moving it.
- Do not remove nor touch items from the freezer compartment if your hands are damp/wet,as this could cause skin abrasions or frost/freezer burns.
- Never use the base,drawers, doors etc. to stand on or as supports.
- Frozen food must not be refrozen once it has been thawed out.
- Do not consume ice popsicles or ice cubes straight from the freezer as this can cause freezer burn to the mouth and lips.
- To avoid items falling and causing injury or damage to the appliance, do not overload the door racks or put too much food in the crisper drawers.

- **WARNING** - Food needs to be packed into bags before it is put into the refrigerator. Liquids need to be stored in bottles or capped containers in order to avoid a spill, as the design structure of the product is not easy to clean.
- This refrigerating appliance is not intended to be used as a built-in appliance.



Caution!

Care and cleaning

- Before maintenance, switch off the appliance and disconnect the mains plug from the mains socket.
- Do not clean the appliance with metal objects, steam cleaner, ethereal oils, organic solvents or abrasive cleansers.
- Do not use sharp objects to remove frost from the appliance. Use a plastic scraper.

Installation Important!

- For electrical connection carefully, follow the instructions given in this manual.
- Unpack the appliance and check if there are damages on it. Do not connect the appliance if it is damaged. Report possible damages immediately to the place you bought it. In this case retain packing.
- It is advisable to wait at least four hours before connecting the appliance to allow the oil to flow back in the compressor.
- Adequate air circulation should be around the appliance, lacking this leads to overheating. To achieve sufficient ventilation, follow the instructions relevant to installation. Wherever possible the back of the product should not be too close to a wall to avoid catching warm parts (compressor, condenser) to prevent the risk of a fire, follow the instructions relevant to installation. touching or catching warm parts (compressor, condenser) to prevent the risk of a fire, follow the instructions relevant to installation.



- The appliance must not be located close to radiators or cookers.
- Make sure that the mains plug is accessible after the installation of the appliance

Service

- Any electrical work required to do the servicing of the appliance should be carried out by qualified electrician or competent person.
 - This product must be serviced by an authorized Service Center, and only genuine spare parts must be used.
7. If the appliance is Frost Free.
 2. If the appliance contains freezer compartment.

 **Warning!**

To avoid a hazard due to instability of the appliance, it must be installed in accordance with the instructions. The incorporated ice-maker can only be installed by the manufacturer and can not be changed by the user. The appliance is intended to be permanently connected to the water mains and not connected by a detachable hose-set.

	Correct Disposal of this product
 	<p>This marking indicates that this product should not be disposed with other household wastes throughout the EU. To prevent possible harm to the environment or human health from uncontrolled waste disposal, recycle it responsibly to promote the sustainable reuse of material resources. To return your used device, please use the return and collection systems or contact the retailer where the product was purchased. They can take this product for environmental safe recycling.</p>

Proper Disposal of Your Old Refrigerator

! WARNING

Suffocation Hazard

Remove doors from your old refrigerator.
Failure to do so can result in death or brain damage.

IMPORTANT: Child entrapment and suffocation are not problems of the past. Junked or abandoned refrigerators are still dangerous— even if they will sit for “just a few days.” If you are getting rid of your old refrigerator, please follow these instructions to help prevent accidents.

Before You Throw Away Your Old Refrigerator or Freezer:

- Take off the doors.
- Leave the shelves in place so that children may not easily climb inside.

Important information to know about disposal of refrigerants:

Dispose of refrigerator in accordance with Federal and Local regulations. Refrigerants must be evacuated by a licensed, EPA certified refrigerant technician in accordance with established procedures.

Parts and Features

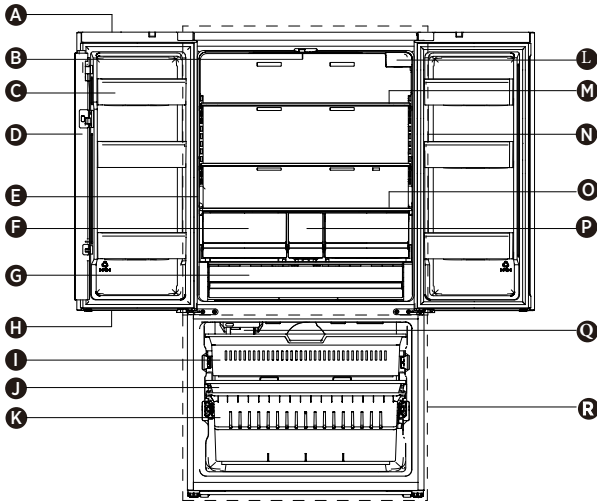

- | | | |
|----------------------------------|---------------------------------|--------------------------------|
| A WiFi Module | G Multifunctional Drawer | M Glass Shelf |
| B Refrigerator LED Light | H Freezer LED Light | N Fridge Compartment |
| C Refrigerator Door Bin | I Freezer Upper Drawer | O Cover |
| D Vertical Baffle Part | J Freezer Middle Drawer | P Middle Storage Drawer |
| E Refrigerator Side Light | K Freezer Lower Drawer | Q Ice-Maker |
| F Storage Drawer | L Water Filter | R Freezer Compartment |

NOTE: Your model may look different from this and other images in this manual, depending on your model's features.

NOTE: To get the best energy efficiency of this product, please place all shelves, drawers on their original position as the illustration above.

Installation Requirements

Location Requirements

WARNING



Risk of fire/ flammable materials

Keep flammable materials and vapors, such as gasoline, away from appliance.
Failure to do so can result in death, explosion or fire.

IMPORTANT: This refrigerator is designed for indoor, household use only.

Temperature

This refrigerator is intended for use in a location where the temperature ranges from a minimum of 16°C to a maximum of 43°C. The preferred room temperature range for optimum performance, which reduces electricity usage and provides superior cooling, is between 16°C and 32°C. It is recommended that you do not install the refrigerator near a heat source, such as an oven or radiator.

Exterior and Dimensions

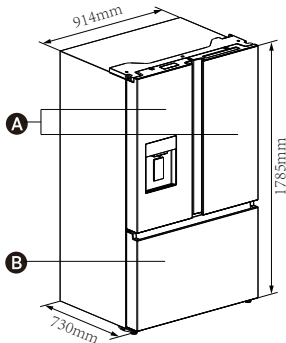

- A Fridge door
- B Freezer door

Ventilation

Adequate air circulation around the refrigerator is required for efficient operation.

To ensure proper ventilation, maintain the recommended clearances.

Recommender Clearances

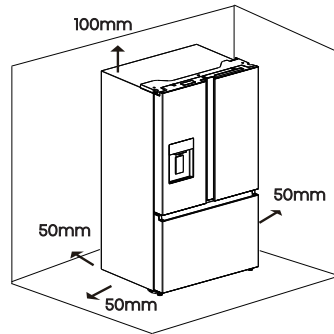

NOTE: If you place the refrigerator next to a fixed wall, leave 1471.4mm minimum space to allow the door to swing open.

Electrical Requirements

WARNING



Electrical Shock Hazard

- Plug into a grounded 3 prong outlet.
- Do not remove the ground prong from the power cord plug.
- Do not use an adapter.
- Do not use an extension cord.
- Failure to do so can result in death, fire or electrical shock.

Before you move your refrigerator into its final location, it is important to make sure you have the proper electrical connection.

Recommender Grounding Method

AC 220-240 volt, 50 Hz, AC only 15- or 20-amp fused, grounded electrical supply is required. It is recommended that a separate circuit serving only your refrigerator be provided. Use an outlet that cannot be turned off by a switch. Do not use an extension cord.

NOTE: Before performing any type of installation or cleaning, disconnect the refrigerator from the electrical source. When you are finished, reconnect the refrigerator to the electrical source and reset the temperature controls to the desired setting.

Installation Instructions

Unpack the Refrigerator

WARNING



Fire or Explosion Hazard

- Do not puncture refrigerant tubing.
- Follow handling instructions carefully.
- Flammable refrigerant used.
- Failure to do so can result in death, explosion or fire.

IMPORTANT: Handle with care when moving refrigerator to avoid either damaging the refrigerant tubing or increasing the risk of a leak.

WARNING

Excessive Weight Hazard

- Use two or more people to move and install refrigerator.
- Failure to do so can result in back or other injury.

Remove the Packaging

- Remove tape and glue residue from surfaces before turning on the refrigerator. Rub a small amount of liquid dish soap over the adhesive with your fingers. Wipe with warm water and dry.

NOTE: Do not use sharp instruments, rubbing alcohol, flammable fluids, or abrasive cleaners to remove tape or glue. These products can damage the surface of your refrigerator. For more information, see "Refrigerator Safety."

- Dispose of/recycle all packaging materials.
- If the refrigerator has been placed in a horizontal or tilted position for any period of time wait 4 hours before plugging it in to allow the oil to settle into the compressor.

When Moving Your Refrigerator:

Your refrigerator is heavy. When moving the refrigerator for cleaning or service, be sure to cover the floor with cardboard or hardboard to avoid floor damage. Always pull the refrigerator straight out when moving it. Do not wiggle or "walk" the refrigerator when trying to move it, as floor damage could occur.

Clean Before Using

After you remove all of the packaging materials, clean the inside of the refrigerator before using it. See the cleaning instructions in "Refrigerator Care."

Important information to know about glass shelves and covers:

Do not clean glass shelves or covers with warm water when they are cold. Shelves and covers may break if exposed to sudden temperature changes or impact, such as bumping. Tempered glass is designed to shatter into many small, pebble-size pieces. This is normal. Glass shelves and covers are heavy. Use both hands when removing them to avoid dropping.

Installation Positioning

- This application perform well from SN to ST. The Appliance may not work properly if it is left for a longer period at a temperature above or below the indicated range.

Climate class	Ambient temperature
SN	+10°C to +32°C
N	+16°C to +32°C
ST	+16°C to +38°C
T	+16°C to +43°C

Door Removal (only if needed)

Measure the refrigerator to make sure it will fit through the doorway. If the refrigerator cannot pass easily through the doorway, follow the instructions to remove the two refrigerator compartment doors and the front panel of the freezer drawer.



WARNING



Electrical Shock Hazard

- Disconnect power before removing doors.
- Reconnect ground wire before operating.
- Failure to do so could result in death or electric shock.

Tools you will need (Not provided)

	
Allen Wrench (4mm)	Wrench (8mm)
	
Phillips Screwdriver	

Remove the Doors

IMPORTANT: Keep the refrigerator doors closed until you are ready to lift them from the cabinet.

1. Unplug refrigerator or disconnect power.
2. Using a Phillips screwdriver, remove the three screws attaching the hinge cover, and then remove the hinge cover with the entire harnesses attached.

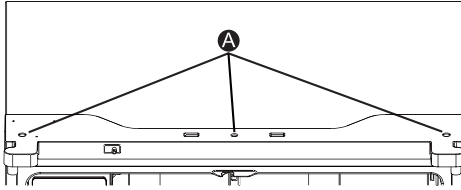

A Screws

3. Separate the two connectors on the left side door. To remove the wire connector, press the top of the connector (B) and separate it from the other one. To remove the water coupler from the hinge, twist and pull the clips from the coupler. Remove the water line (C) while pressing the movable part (D) of the water line coupler.

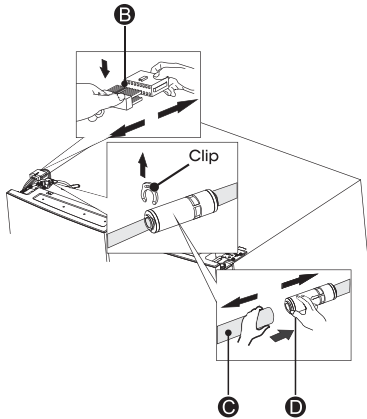

4. Remove the 3 screws (E) fixed on the hinges, with a Wrench (8mm) and 1 ground screws (F) attached to the hinge with Philips (+) screwdriver. Remove the upper left door hinge (G).

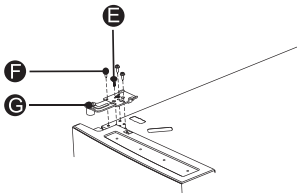

5. Use your both hands to open the door more than 90°. Lift it up and take it off.

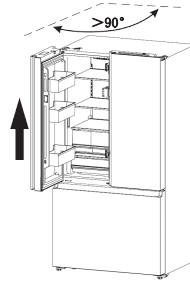

6. If necessary, remove the 2 hex head bolts hinges (I) with an Allen wrench (5 mm). Remove the lower left door hinge (H).

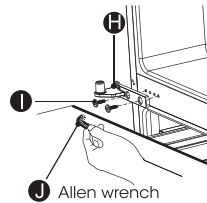

7. Pull out the freezer compartment door and freezer middle drawer completely .

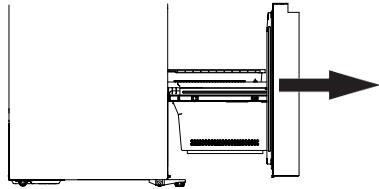

8. Lift the freezer middle drawer up 45 degrees and take it out.

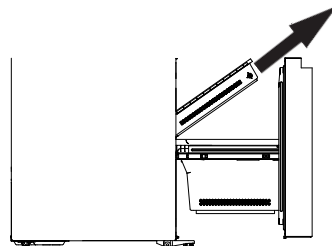

9. Lift the freezer lower drawer up 45 degrees and take it out.

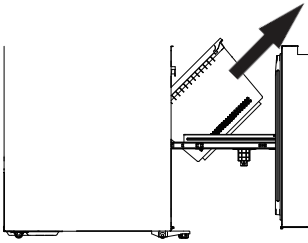

10. Remove the screws on both sides indicated by the arrows.

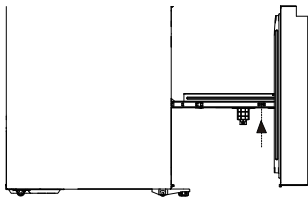

11. Lift the freezer compartment door up 45 degrees and take it out.

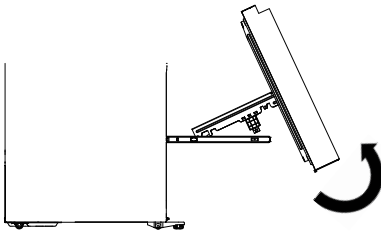

Replace the Doors

1. If removed, reinstall the bottom hinge.
2. Using two or more people, set the refrigerator door onto the bottom hinge.
3. Insert the top hinge into the top of the door.
4. Using the three screws removed earlier, fasten the top hinge to the top of the cabinet.
NOTE: Left-hand door only, replace the ground screw into the top hinge, reattach the wire harness, reconnect the water line, make sure the clips are properly connected to the coupler.
5. Repeat steps 1 through 4 to replace the opposite door.
6. Using the three screws removed earlier, reinstall the top hinge cover and control panel to the top of the cabinet.

Installing the water lines

A water dispenser with a filter is one of the helpful features on your new appliance.







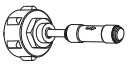

To help promote better health, the water filter removes unwanted particles from your water. However, it does not sterilize or destroy microorganisms. You may need to purchase a water purifying system to do that. In order for the ice maker to operate properly, a water line is required.

- the maximum inlet water pressure is 700kPa;
- the minimum inlet water pressure is 207kPa.

NOTE: The quality of your ice will be only as good as the quality of the water supplied to your ice maker. Avoid connecting the ice maker to a softened water supply. Water softener chemicals (such as salt) can damage parts of the ice maker and lead to poor quality ice. If a softened water supply cannot be avoided, make sure the water softener is operating properly and is well-maintained.

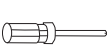
Parts for water line installation

The tools you will need:

			
Connector and check valve	Valve Seat	Clip	Screw
			
Phillips screwdriver	Water line (5m)	Two-Way Connector	Spanner

Connecting to the water supply line

The connector and the check valve are provided as one part. You should use the new connector incidentally but not the old one you have.

First, turn off the main water supply line. Screw the adaptor onto a suitable 3/4" BSP connector water outlet and use the spanner to tighten it. Fully insert the water line into the check valve. Then insert the clip in the install pack as the figure shown below.

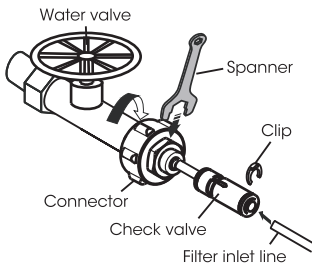

To prevent the clips loose, use the valve seat to hold it. Then use the screw to hold the valve seat with Philips(+) screwdriver.

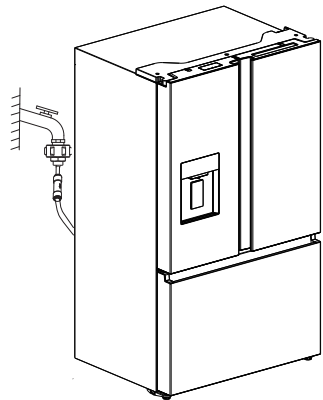
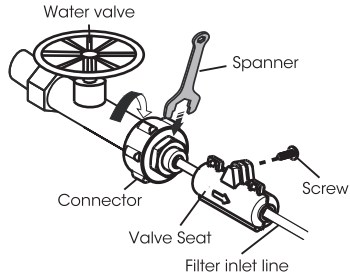

NOTE:

- After connected to the water supply line, please open the water valve to flush the filter for 5 minutes before use.
- If the main supply line is too far away from the refrigerator to be connected to the filter inlet line, the water line(5m) provided may be helpful. The outlet line of the water filter should be connected with the inlet line of the refrigerator by a Two-Way Connector. The water line must be fully inserted into the center of the connector to prevent water leaking. Insert the 2 clips in the installation pack as shown in the diagram, and then confirm that each clip holds the line firmly.

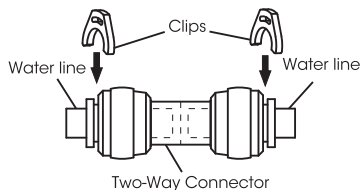

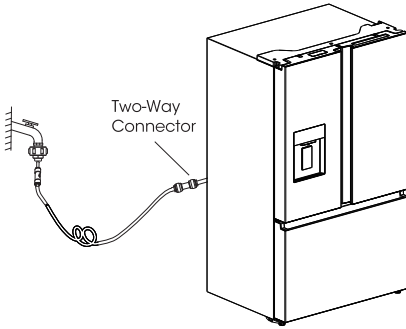

- The initial dark discoloration of water is normal.
- The water lines must be connected with the potable water only.
- The water lines should not be pressed by heavy things and should not bend too much.
- It is normal that there will be sound of exhaust coming out from the appliance when you connect the water line to the appliance and press the level of the dispenser for the first time.

Warning:

- After turning on the water valve, make sure that there is no leakage at all connection points of the water lines. If there is a leakage, turn off the valve immediately and tighten the water connector or make the lines fully inserted into the connector.
- The water line must be connected to the cold water pipe. If it is connected to the hot water pipe, it may cause the purifier to malfunction.

Complete the Installation

⚠ WARNING

Electrical Shock Hazard

Plug into a grounded 3 prong outlet.
Do not remove the ground prong from the power cord plug.
Do not use an adapter.
Do not use an extension cord.
Failure to do so can result in death, fire or electrical shock.

1. Plug into a grounded 3 prong outlet.
NOTE: This refrigerator begins operating as soon as it is connected to the power supply.
2. Move the refrigerator into its final location, making sure to maintain the recommended clearance.

Level Refrigerator if needed

The refrigerator must be level to maintain optimal performance and appearance.

1. Turn the leveling feet on the bottom, front of the cabinet to raise or lower that side of the refrigerator until the refrigerator is level side to-side.
2. Turn both feet, by the same amount, to slightly raise the front of the refrigerator. This will make it easier for the doors to close.

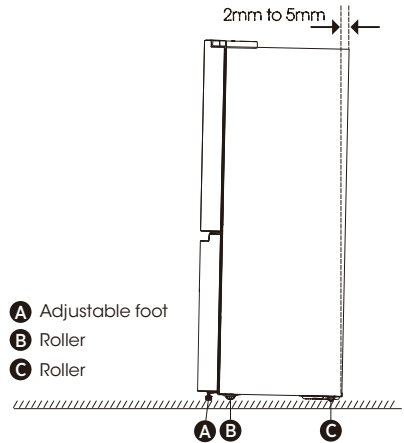

NOTE: Having someone push against the top of the refrigerator takes some weight off the leveling feet. This makes it easier to turn the feet. Rotate the adjustable feet clockwise to raise or raise counter-clockwise to lower your refrigerator. To make sure that the doors close automatically, tilt the top of your refrigerator backward about 10mm to 15mm. If necessary, use a spanner wrench to adjust the feet.

Align Doors (if needed)

The gaskets is used to align doors, you can find them in the manual bag.

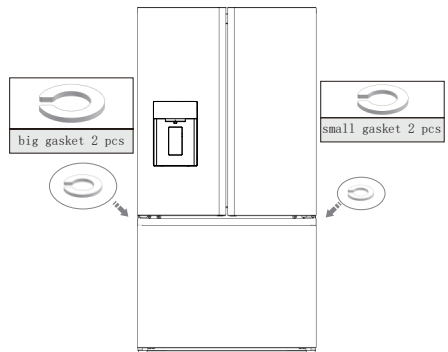

Refrigerator Use

Opening and Closing Doors

Providing room for doors to open

Make sure that you have enough room in front of your refrigerator to swing the doors open.

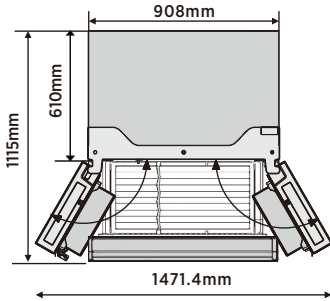

The four doors can be opened and closed either separately or together.

- There is a mullion on the left-hand side refrigerator compartment door.
- When closing the left-hand door, the mullion folds behind the right-hand door joining the two doors.
- The temperature of the door frame is controlled

to help prevent moisture from developing on the mullion. The temperature of the surface may be warm, which is normal, and will not affect the performance of the refrigerator.

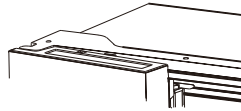

NOTE: Before closing the left-hand door, make sure the mullion is folded inward. If the mullion is pulled outward it may become damaged when you try to close the door.

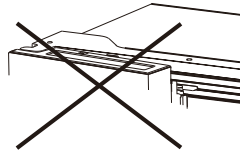

Using the Controls

Your product has one control panel which is on the fridge door. Use your appliance according to the following control guidelines.

Control Panel

The control panel shows in the diagram below.

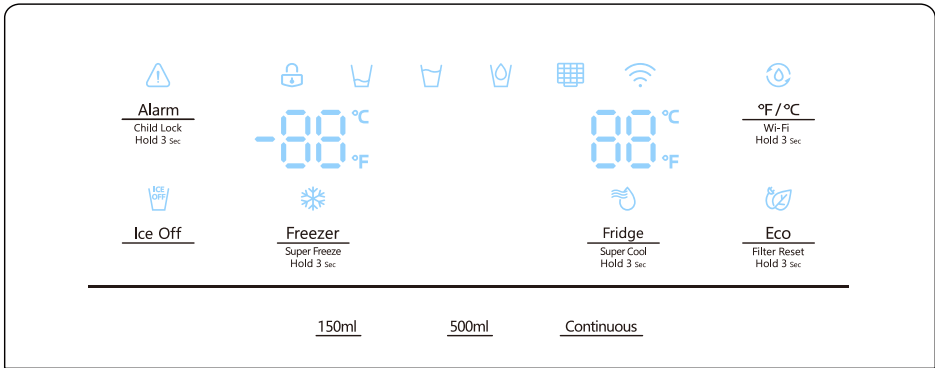

The display will illuminate when the refrigerator is first plugged in. However, the lights will automatically turn off after 60 seconds.

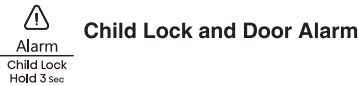

This button serves two purposes:

1. Child Lock

Press and hold "Alarm" for 3 seconds to lock the whole Control Panel including dispenser function. If Control panel is locked, the icon "🔒" will be on, and none of the buttons on the Control panel work. To unlock the Control panel, please press and hold "Alarm" for 3 seconds again.

2. Door Alarm

Leaving any door open for over 2 minutes will activate door alarm. The "⚠️" icon will flicker, the control panel will display "dr", and you will hear a buzzer sound. The buzzer will sound 3 times per minute and will stop after 8 minutes. In case of alarm, you can touch the Alarm button to cancel door alarm, then the "⚠️" icon stop flickering and keep on, the buzzer sound will stop at the same time. Also door alarm can be stopped by closing all the doors.

To save energy, please avoid keeping doors open for a long time when using refrigerator.



When the Child Lock is off, you can touch the "°F/°C" button to switch between Celsius and Fahrenheit units. When it is switched to Fahrenheit, the icon "🌡️" will be on.



This button controls the ice maker. You can touch "Ice Off" button to control the ice maker. When the Child Lock is off, you can touch the "Ice Off" icon to lock the ice maker, and the icon "🧊" will be illuminated. If you want to unlock the ice maker, please touch the "Ice Off" icon again, and the icon "🧊" will be off.



Fridge Temperature Control

When you touch the button continuously, the temperature will be set in the following sequence.

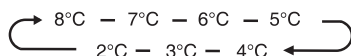

If you have set the temperature type to Fahrenheit, the temperature settings cycle from 46°F to 36°F.

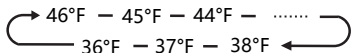

If you want to decrease the time needed to cool products in the Fridge, please touch and hold this button for 3 seconds, the Super Cool icon "❄️" will be illuminated, the fridge temperature setting displays 2°C (or 36°F). Super Cool automatically switches off after 3 hours, and the refrigerator temperature setting will revert back to the previous setting. When Super Cool functioning is on, you can touch the "Fridge" to switch it off.

NOTE: On the Super Cool function, when you touch the "Eco" button, "Eco" function will be activated, and "Super Cool" mode will be off.



Freezer
Super Freeze
Hold 3 sec

Freezer Temperature Control

You can touch the "Freezer" button to activate the mode to control the freezer temperature. When you press the button continuously, the temperature will be set in the following sequence.

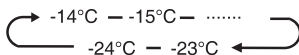

If you have set the temperature type to Fahrenheit, the temperature settings cycle from 7°F to -11°F.

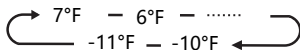

Press and hold the button for 3 seconds, the icon "❄️" will be illuminated, the freezer temperature setting displays -24°C (or -11°F). Super Freeze can quickly lower the temperature and freeze your food faster than usual. This can retain more of the vitamins and nutrition in fresh food and keep your food longer. Super Freeze automatically switches off after 52 hours, and the freezer temperature setting will revert back to the previous setting. When the Super Freeze function is on, you can touch "Freezer" to switch off the Super Freeze function.

The Super Freeze is used to perform pre-freezing and fast freezing in sequence of Freezer compartment. This function accelerates the freezing of fresh food and, at the same time, protects foodstuffs already stored from undesirable warming.



To freeze fresh food activate the Super Freeze function at least 24 hours before placing the food to complete pre-freezing

NOTE:

On the Super Freezer Function, when you touch the "Eco" button, "Eco" function will be activated, and "Super Freezer" mode will be off.

Water Dispense Control

When the Child Lock is on, the dispenser will not work. When the Child Lock is off, you can press the "150ml" or "500ml" option to choose the volume of water to be dispensed, and press the "Continuous" button will activate the continuous water mode. If you choose the function of "150ml", the "150ml" icon will be illuminated, choose the function of "500ml" the "500ml" icon will be illuminated, and the "Continuous" icon will be illuminated when "Continuous" function is chosen.

When uses "150ml" or "500ml" to fetch water, it automatically switches to the continuous water fetching function after 30 seconds. During the process of fetching water, it is forbidden to switch the three outlet modes of 150ml, 500ml and Continuous. It is necessary to release the water intake switch before it can be operated.



Eco
Filter Reset
Hold 3 sec

Energy Save

You can touch this button to turn Energy Save mode on and off. When you turn Energy Save on, the Eco icon "🌿" lights.

The temperature of the fridge is automatically switched to 6°C (or 43°F) and the freezer to -17°C (or 1°F). If Energy Save is off, the icon "🌿" will go off and the temperature setting will revert back to the previous setting.

Water Filter

The first time the power is switched on and the water enters the filter, the filter state is calculated at 99%. When the water filter state drops to 15%, the icon "🧼" is lit. When the filter state reaches 10%, the icon "🧼" will flash. The user needs to replace the filter and long press the Energy Save Button for 3 seconds to reset the water filter state. The filter state will then be re-calculated to 99%.

Demo mode

Demo mode is for store display, and it prevents the refrigerator from generating cool air. In this Cooling off Mode, the refrigerator may seem like it is working but it will not make cool air. The indicators on the control panel will show "OF". To cancel this mode, press and hold "Alarm" and "F / °C" keys at the same time for 3 seconds and the buzzer gave a long sound.

Wi-Fi function

This appliance may be controlled remotely with a smart phone or a tablet computer. If the appliance is not connected to the home network, it will function like a regular appliance.

What do you need to connect the appliance?

- Signal from the local wireless network (Wi-Fi) should be sufficiently strong in the spot where the appliance is installed.
- Home network router has to be connected to the internet, and the Wi-Fi function on the appliance should be activated.
- The smart phone/tablet computer has to be connected to the internet.
- Operating system on your smart phone/tablet computer should be compatible with the ConnectLife app.

APPLIANCE Wi-Fi STATE

There are three WiFi states as shown below, you can activate the display board according to the relevant steps.

● CONNECT APPLIANCE TO Wi-Fi

After activating the Wi-Fi function, connect your device to your home router in order to connect your appliance with the ConnectLife mobile app.

- Step 1:** Set the appliance to normal operation. Touch the Wi-Fi icon for approximately 3 seconds. You entered network connection menu when ' - - ' appears in the display.
- Step 2:** Touch the Fridge key to select ' O ' within 60 seconds.
- Step 3:** Touch the Wi-Fi icon to confirm the selection mode. The Wi-Fi symbol starts blinking and the network of this appliance is now open to connect to, for 5 minutes.
- Step 4:** When the Wi-Fi symbol is on, it means that the Wi-Fi connection is successful. The display will return to normal.

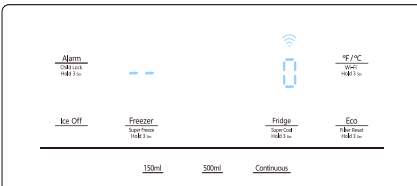

● MULTI-USER PAIR APPLIANCE

The appliance can be paired with your mobile device. Simply pair another user to your appliance. This requires, that your appliance was already to be set up before and is connected to your home network. If not, go back and select SET UP APPLIANCE.

- Step 1:** Set the appliance to normal operation. Touch the Wi-Fi icon for approximately 3 seconds. You entered network connection menu when ' - - ' appears in the display.
- Step 2:** Touch the Fridge key to select ' P ' within 60 seconds.
- Step 3:** Touch the Wi-Fi icon to confirm the selection mode. The PAIR network of this appliance is now open to connect to, for 5 minutes.
- Step 4:** When the display returns to normal, it means the PAIR connection is successful.

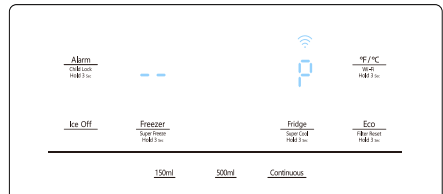

● UNBIND ALL USERS OF APPLIANCE

By activating this function, the user information stored in the appliance will be deleted, and appliance will be removed from all paired app user accounts.

- Step 1:** Set the appliance to normal operation. Touch the Wi-Fi icon for approximately 3 seconds. You entered network connection menu when ' - - ' appears in the display.
- Step 2:** Touch the Fridge key to select ' 88 ' within 60 seconds.
- Step 3:** Touch the Wi-Fi icon to confirm the selection mode to realize unbinding.
- Step 4:** After the device is unbound, it will automatically enter the distribution network state, the Wi-Fi icon  flashes, and the distribution network time is up to 5 minutes.

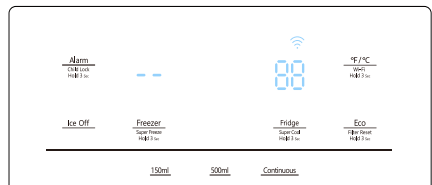

INFORMATION!

We recommend downloading and installing the mobile app and creating a ConnectLife account before attempting to set up the connection with your appliance.

ConnectLife App

The ConnectLife App is available to download free of charge from the Apple App Store or from the Google Play Store.



Installing the ConnectLife app

1. Go to the App Store (on Apple devices), AppGallery (on Huawei devices) or Google Play Store (on Android devices) on your phone/tablet computer.
2. Search for "ConnectLife".



3. Choose the ConnectLife app and install it on your smart phone/tablet computer.

Add Refrigerator on APP

1. Select 'Add appliances' or '+'. .
2. Select 'Refrigerator' .
3. Open the Camera on App to scan the appliance SN code(barcode). The 23-bit barcode can be found under the data plate on the inside of the refrigerator.
4. Select 'SET UP APPLIANCE', follow the instruct and make sure Wi-Fi function of the appliance is activated, then select 'Next'.

Note: When the appliance has connected to the home network and other users want to pair the same appliance, they can directly select 'PAIR APPLIANCE' to bind.

5. Turn on bluetooth as prompted, you are now presented with the appliance (refrigerator HIS -XXXX), then select it.

6. Select secure Wi-Fi option, input the password and connect.
7. Select the location of appliance and save.
8. Add successful, you are now able to control appliance remotely.

Note!

- The control panel will light up when the door is open or you touch any button.
- The light will go off without touching any button or the doors have been closed for one minutes.
- When the refrigerator is powered on, all the icons of the control panel will light up for 3 seconds, and a buzzer sounds. The Child Lock is off. And the temperature setting reverts back to the previous setting.

- As the application continues to be upgraded, please refer to the actual display interface.

User manual:

- Transmitting frequency band(s) and max allowed transmitting power in the operating frequency band(s): 2040-2483.5MHz, less than or equal to 20dbm.
- This equipment should be installed and operated with minimum distance 20cm between the radiator & your body.

Features

Important information to know about glass shelves and covers:

Do not clean glass shelves or covers with warm water when they are cold. Shelves and covers may break if exposed to sudden temperature changes or impact, such as bumping. Tempered glass is designed to shatter into many small, pebble-size pieces. This is normal. Glass shelves and covers are heavy. Use both hands when removing them to avoid dropping.

1.Refrigerator

IMPORTANT: To avoid damage to the doors, make sure all shelves and drawers are pushed fully into the cabinet before closing a door.

Adjustable Shelves

The height of the shelves can be adjusted to fit your storage needs.

1. To remove a shelf, gently lift upward and then pull the shelf forward until the end of the shelf is past the rail support.

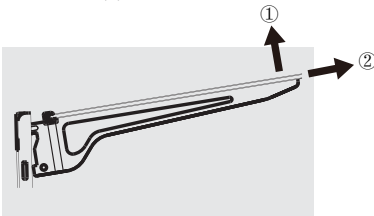

2. To reinstall a shelf, gently slide the shelf back into the refrigerator compartment, and then lower the shelf onto the rail support.

2.Removable door bins

The bins located in the middle of the door are adjustable.

To Remove and Replace a Door Bin:

1. Place hands on both sides of the bin and lift upward.
2. Pull the door bin out.
3. Replace the door bin by inserting it above the support and pressing down to snap into place.

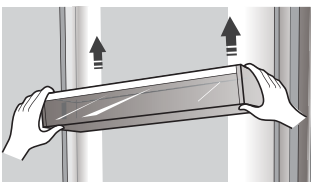

3.To Remove/Replace freezer drawer

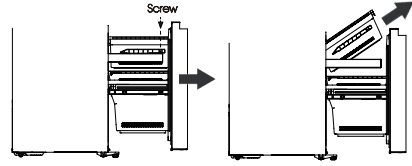

1. Pull out the freezer compartment door and freezer upper drawer completely .
2. Remove the screws on both sides indicated by the arrows.
3. Lift the freezer upper drawer up 45 degrees and take it out.
4. Lift the freezer middle and lower drawer up 45 degrees and take it out.

4.Getting cold water and making ice

Getting cold water

The water dispenser is located in the fridge door. To get water, touch the "150ml" or "500ml" or "Continuous" button on the display panel to choose the different modes, then put the glass in suitable place and press down the impact pole. After taking the water, keep the glass in place for 2 seconds to prevent water from dripping out.



Making ice

- Following installation, allow 24 hours to produce the first batch of ice. Discard the first three batches of ice produced. Allow 2 to 3 days to fill the ice storage container.
- If the ice in the ice container clumps, break up ice using a plastic utensil and discard. Do not use a sharp tool to break up the ice. This can cause damage to the ice container.
- Do not store any items other than ice in the ice storage container.

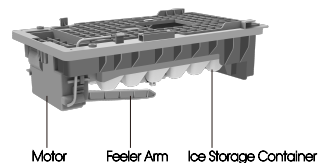

NOTE:

- The inside of the ice bucket is very cold when the refrigerator is operating. Don't reach deep inside the ice bucket.
- Use only the ice maker provided with the refrigerator. The water supply to this refrigerator must only be installed by a suitably qualified person.
- To operate the ice maker properly, water pressure of 30~125 psi is required.

Going on vacation

If you have a long vacation or business trip and won't use the water or ice dispensers for a long time:

1. Close the water valve. Otherwise, water leakage may occur.
2. Remove all food.
3. Unplug the refrigerator.
4. Wipe excess moisture from inside and leave the doors open. Otherwise, odor and mold may develop.

Warning:

- Do not put your fingers, hands or any other unsuitable objects in the chute or ice-maker bucket. It may result in personal injury or material damage.
- Never put your fingers or any other objects in the dispenser opening. It may cause injury.
- Do not try to disassemble the ice maker.
- Do not wash or spray the ice bucket with water while it is in the refrigerator. Remove it to clean it.

Water clouding phenomenon

All water provided to the refrigerator flows through the filter which is an alkaline water filter. In the filtering process, the pressure of the water that has flowed out of the filter is increased, and the water becomes saturated with oxygen and nitrogen. When this water flows out into the air, the pressure plummets and the oxygen and nitrogen get supersaturated, which results in gas bubbles. The water may temporarily look misty or cloudy due to these oxygen bubbles. After a few seconds, the water will look clear.

Cleaning

After using for a period, water accumulated in receiving tank might overflow, thus you should clean it with dry towel regularly to avoid water spilling out onto the floor.

NOTE:

In case of stained by dust or other pollutant, dispensing water with unpleasant smell, etc., water dispenser parts should be cleaned thoroughly.

5.Using your fridge compartment

The refrigerator compartment is suitable for storage of vegetables and fruit. Food inside should be packed to store in order to avoid losing moisture or flavor permeating into other foods.

Caution

Never close the refrigerator door while the shelves, crisper and/or telescopic slides are extended. It may damage both them and the refrigerator.

Door baskets

The refrigerator compartment is provided with several different door baskets, which are suitable for the storage of canned liquid, bottled drink and packed food.

To remove the door baskets, simply lift the To racks up and pull straight out. relocate the door baskets, slide it in above the desired location and push down until it stops.

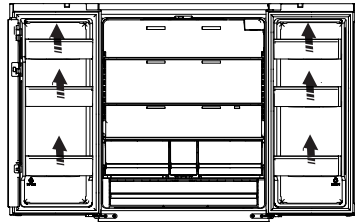

Warning:

Do not place too many heavy things in the baskets. Before you lift up the door shelf vertically, please take the food out.

Glass shelves

To remove the glass shelves, tilt up the front of the shelf in the direction shown (1) and lift it up vertically (2). Pull the shelf out.

6. Changing the water filter

To drink the freshest and cleanest water from your refrigerator, change the filter on time. To change the water filter, follow these steps:

1. Shut off the water supply. Pull out the cover (B) about 1.5 cm and open.

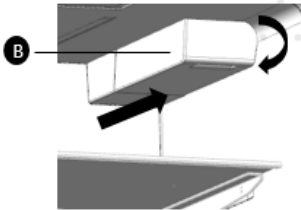

2. Turn the water filter (C) about 1/4 turn, counter-clockwise. Then pull the water filter from the filter holder.

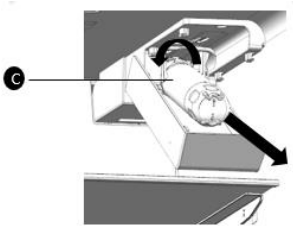

Note:

- Sometimes, it is hard to disassemble the water filter because impurities in the water cause it to stick. If you are having difficulties, grip the water filter firmly and pull it out.
- When you pull the water filter, a little water can leak from the opening. This is normal. To minimize the water leaks, keep the filter cartridge horizontal when pulling it. To insert the new water filter, follow the directions below.

3. Insert the new filter into the filter holder.

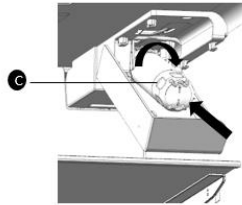

4. Push the filter, and then turn it clockwise until it locks

- If you have trouble inserting the water filter because of high water pressure, shut off the water supply valve.

5. If you turned off the water supply, turn it back on.

Note:

- After turning on the water supply, you should check the leaks. If leaks occur, repeat the steps 1-5.
- If leaks persist, discontinue use and call customer service.

Removing any residual matter inside the water supply line after installing the water filter

1. After the water filter is replaced, dispense 2.5 gallons of water (flush for approximately 5 minutes) to remove trapped air and contaminants from the system.
2. Additional flushing may be required in some households.
3. Open the refrigerator door and make sure there are no water leaks coming from the water filter.

Note:

- Sometimes, it is hard to disassemble the water filter because impurities in the water cause it to stick. If you are having difficulties, grip the water filter firmly and pull it out.

- Be sure to flush the dispenser thoroughly, otherwise water may drip from the dispenser. This means that there is still air in the line.
- Do not dispense the entire 2.5 gallon amount continuously. Depress and release the dispenser pad for cycles of 30 seconds ON and 60 seconds OFF.

Reverse osmosis water supply:

The pressure of the water supply coming out of a reverse osmosis system going to the water inlet valve of the refrigerator needs to be between 30 and 100psi (207 and 700kPa). If a reverse osmosis water system is connected to your cold water supply, the water pressure to the reverse osmosis system needs to be a minimum of 40 to 60 psi (276 to 414 kPa). If the water pressure to the reverse osmosis system is less than 40 to 60 psi (276 to 414 kPa):

- Check to see whether the sediment filter in the reverse osmosis system is blocked. Replace the filter if necessary.
- Allow the storage tank on the reverse osmosis system to refill after heavy usage.
- If your refrigerator has a water filter, it may further reduce the water pressure when used in conjunction with a reverse osmosis system. To resolve it, remove the water filter.

General Use Information

- When first turning on refrigerator after a period of non-use, allow the refrigerator to cool at least 2 hours before adding food.
- Do not block air circulation vents with stored items.
- Store items so that the air can circulate freely around them.
- Cover or wrap stored food well to avoid transfer of odors.
- Once defrosted, food quality will deteriorate rapidly. Defrosted food should not be refrozen.

• Neither bottled nor canned drinks should be stored in the freezer compartment. Bottles and cans may explode.

To avoid contamination of food, please respect the following instructions:

- Opening the door for long periods can cause a significant increase of the temperature in the compartments of the appliance.
- Clean regularly surfaces that can come in contact with food and accessible drainage systems.
- Store raw meat and fish in suitable containers in the refrigerator, so that it is not in contact with or drip onto other food.

Order	Compartments Type	Target storage temp.[°C]	Appropriate food
1	Fridge	+2~+8	Eggs, cooked food, packaged food, fruits and vegetables, dairy products, cakes, drinks and other foods which are not suitable for freezing.
2	(***)*-Freezer	≤ -18	Seafood (fish, shrimp, shellfish), freshwater aquatic products and meat products (recommended for 3 months ,the longer the storage time, the worse the taste and nutrition),suitable for frozen fresh food.

NOTE: please store different foods according to the compartments or target storage temperature of your purchased products.

If the refrigerating appliance is left empty for long periods, switch off, defrost, clean, dry, and leave the

door open to prevent mould developing within the appliance.

Compliance is checked by inspection.

Refrigerator Care

Cleaning

Both the refrigerator and freezer sections defrost automatically. However, clean both sections about once a month to avoid buildup of odors. Wipe up spills immediately. To avoid odor transfer and drying out of food, wrap or cover foods tightly.

WARNING



Explosion Hazard

Use nonflammable cleaner.

Failure to do so can result in death, explosion or fire.

IMPORTANT:

- Do not use harsh chemicals, ammonia, chlorine bleach, concentrated detergent, solvents, abrasives or metal scouring pads to clean your refrigerator inside or out. They can damage and/or discolor the refrigerator finish.
- Do not use warm water to clean glass shelves while they are still cold. Glass may break when exposed to sudden temperature changes or

Shelf parts clean

- When cleaning the shelf parts, remove the lower shelf parts should be placed horizontally, either front or back, to prevent the shelf support from falling off.
- If the shelf parts are placed at an angle and the side of the shelf parts touch the ground. When the cleaning force is not correct, the shelf bracket is easy to fall off.

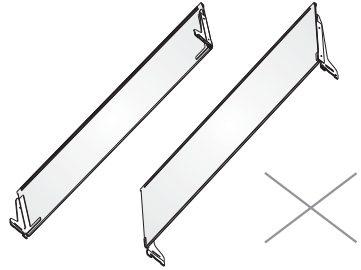
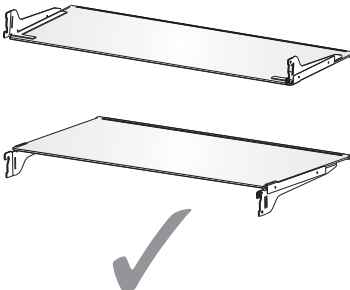

WARNING



Electrical Shock Hazard

Unplug your appliance or disconnect power before cleaning.

Failure to do so can result in death, electric shock or personal injury.

1. Unplug refrigerator or disconnect power.
2. Clean the interior.

Hand wash, rinse, and dry removable parts and interior surfaces thoroughly. Use a clean sponge or soft cloth and a mild detergent in warm water.

3. Clean the door seals (gaskets). A dirty or sticky door seal may adhere to the cabinet and tear when you open the door.

Using a soft cloth and a solution of mild detergent and warm water, hand wash the door seals. Rinse with clear water and dry thoroughly.

4. Clean the exterior surfaces.

Wash exterior surfaces with a clean, soft cloth or sponge and a mild detergent in warm water. Rinse surfaces with clean, warm water and dry immediately to avoid water spots.

5. Plug in refrigerator or reconnect power.

Lights

This product contains a light source of energy efficiency class G on the top and side of the refrigerating chamber.

IMPORTANT: Your refrigerator is equipped with LED lighting. These lights are designed to last for the life of your refrigerator. However, if the lights stop operating, please contact a qualified technician for replacement.

Vacation and Moving Care

Vacation

If You Choose to Leave the Refrigerator On While You're Away:

1. Use up any perishables and freeze other items.

If You Choose to Turn Off the Refrigerator Before You Leave:

1. Remove all food from the refrigerator and freezer.
2. Unplug refrigerator or disconnect power.
3. Clean refrigerator, wipe it, and dry well.
4. Tape rubber or wood blocks to the tops of both doors to prop them open far enough for air to get in. This stops odor and mold from building up.

Moving

WARNING



Fire or Explosion Hazard

Do not puncture refrigerant tubing.
Follow handling instructions carefully.
Flammable refrigerant used.
Failure to do so can result in death, explosion or fire.

IMPORTANT: Handle with care when moving refrigerator to avoid either damaging the refrigerant tubing or increasing the risk of a leak.

WARNING

Excessive Weight Hazard

Use two or more people to move and install refrigerator.
Failure to do so can result in back or other injury

When you are moving your refrigerator to a new home, follow these steps to prepare it for the move.

1. Remove all food from the refrigerator and pack all frozen food in dry ice.
2. Unplug refrigerator.
3. Clean, wipe, and dry thoroughly.
4. Take out all removable parts, wrap them well, and tape them together so they don't shift and rattle during the move.

5. Raise the leveling legs so they don't scrape the floor. See "Level Refrigerator."
6. Tape the doors closed and tape the power cord to the back of the refrigerator. When you get to your new home, put everything back and refer to the "Installation Instructions" section for preparation instructions.

Reinstalling/Using Refrigerator Again

If the refrigerator has been placed in a horizontal or tilted position for any period of time wait 4 hours before plugging it in to allow the oil to settle into the compressor.

1. Clean refrigerator. See "Cleaning."
2. Place refrigerator in desired location and level. See "Installation Instructions."

WARNING



Electrical Shock Hazard

Plug into a grounded 3 prong outlet.
Do not remove the ground prong from the power cord plug.
Do not use an adapter.
Do not use an extension cord.
Failure to do so can result in death, fire or electrical shock.

3. Plug into grounded 3 prong outlet.

Troubleshooting

Try the solutions suggested here first in order to avoid the cost of an unnecessary service call.
Refrigerator is Not Operating

Problem	Possible Cause & Solution
Appliance is not working correctly	Check whether the power cord is plugged into the power outlet properly.
	Check the fuse or circuit of your power supply, replace if necessary.
	The room temperature may be too low. Try setting the refrigerator or freezer temperature to a colder level to solve this problem.
	It is normal that the freezer is not operating during the defrost cycle, or for a short time after the appliance is switched on to protect the compressor.
Odors from the compartments	The interior may need to be cleaned
	Some food, containers or wrapping may cause odors.
Noise from the appliance	<p>The sounds below are quite normal:</p> <ul style="list-style-type: none"> • Compressor running noises. • Air movement noise from the small fan motor in the freezer compartment or other compartments. • Gurgling sound similar to water boiling. • Popping noise during automatic defrosting. • Clicking noise before the compressor starts. • Clicking noise when you get the water. • The motor running noises when you get ice.
	<p>Other unusual noises are due to the reasons below and may need you to check and take action:</p> <p>The cabinet is not level. The back of appliance is touching the wall. Bottles or containers have fallen or are rolling.</p>
Water dispenser is not functioning	<ul style="list-style-type: none"> • Did you wait for 12 hours after installation of the water supply line before making ice? If it is not sufficiently cool, it may take longer to make ice, such as when first installed. • Is the water line connected and the water valve open? • Did you manually stop the icemaking function? Make sure you do not set the "Ice Off" mode. • Is there any ice blocked with in the icemaker bucket? • Is the water pressure less than 30psi? Install a booster pump to compensate for the low pressure. • Is the freezer temperature too warm? Try setting the freezer temperature lower. • Icemaker is not making the ice fast enough. Please wait for at least 90 minutes.

<p>The motor runs continuously</p>	<p>It is normal to frequently hear the sound of the motor, it will need to run more when in following circumstances:</p> <ul style="list-style-type: none"> • Temperature setting is set colder than necessary. • Large quantity of warm food has recently been stored with in the appliance. • The temperature outside the appliance is high. • Doors are kept open too long or too often. • After first installing the appliance or if it has been switched off for a long time.
<p>A layer of frost occurs in the compartment</p>	<p>Check that the air outlets are not blocked by food and ensure food is placed within the appliance to allow sufficient ventilation. Ensure that door is fully closed. To remove the frost, please refer to the Cleaning and Care chapter.</p>
<p>Temperature inside is too warm</p>	<p>You may have left the doors open too long or too frequently; or the doors are kept open by some obstacle; or the appliance is located with insufficient clearance at the sides, back and top.</p>
<p>Temperature inside is too cold</p>	<p>Increase the temperature by following the "Display Controls" chapter.</p>
<p>Doors can't be closed easily</p>	<p>Check whether the top of the refrigerator is tilted back by 0.4"-0.6"(10-15mm) to allow the doors to self-close, or if something inside is preventing the doors from closing.</p>
<p>The light is not working</p>	<ul style="list-style-type: none"> • The LED light may be damaged. Refer to replace LED lights in "Cleaning and Care" chapter. • The control system has disabled the lights due to the door being kept open too long. Close and reopen the door to reactivate the lights.
<p>Hear water bubbling in the refrigerator</p>	<p>This is normal. The bubbling comes from the refrigerant coolant liquid circulating through the refrigerator.</p>
<p>Water dispenser is not functioning</p>	<ul style="list-style-type: none"> • Is the water line connected and the water valve open? • Has the water line been crushed or kinked? Make sure the waterline is free and clear of any obstruction. • Is the water tank frozen because the refrigerator temperature is too low? Try selecting a warmer setting on the display panel. • Check if the filter is properly installed. If it is not properly installed, the water dispenser may not work.

Hisense Service Help Line: 0191 387 0804



Hisense UK Ltd

Ground floor Munroe Court

White Rose Office Park

Millshaw Park Lane

Leeds LS11 0EA