

Hisense

life reimagined

USER'S OPERATION MANUAL

Before operating this unit, please read this manual thoroughly, and retain for future reference

English

Contents

Safety and warning information.....2	Using your appliance.....14
Installing your new appliance.....8	Helpful hints and tips.....15
Description of the appliance.....9	Cleaning and care.....16
Reversing the door.....10	Troubleshooting.....18
Operation.....13	Disposal of the appliance.....19



Safety and warning information

For your safety and correct usage, before installing and first using the appliance, read this user manual carefully, including its hints and warnings. To avoid unnecessary mistakes and accidents, it is important to make sure that all people using the appliance are thoroughly familiar with its operation and safety features. Save these instructions and be sure that they remain with the appliance if it is moved or sold, so that anyone using it throughout its life, will be properly informed on its usage and safety notices.

For the safety of life and property, keep the precautions of these user's instructions as the manufacturer is not responsible for damages caused by omission.

Safety for children and others who are vulnerable people

- According to EN standard

This appliance can be used by children aged from 8 years and above and persons with reduced physical, sensory or mental capabilities or lack of experience and knowledge if they have been given supervision or instruction concerning use of the appliance in a safe way and understand the hazards involved. Children shall not play with the appliance. Cleaning and user maintenance shall not be made by children without supervision.

Children aged from 3 to 8 years are allowed to load and unload refrigerating appliances.

- According to IEC standard

This appliance is not intended for use by persons (including children) with reduced physical, sensory or mental capabilities, or lack of experience and knowledge, unless they have been given supervision or instruction concerning

use of the appliance by a person responsible for their safety. **Children should be supervised to ensure that they do not play with the appliance.**

- Keep all packaging away from children as there is risk of suffocation.
- If you are discarding the appliance, pull the plug out of the socket, cut the connection cable (as close to the appliance as you can) and remove the door to prevent children playing from suffering an electric shock or from closing themselves inside it.
- If this appliance, featuring a magnetic door seals, is to replace an older appliance having a spring lock (latch) on the door or lid, be sure to make the spring lock unusable before you discard the old appliance. This will prevent it from becoming a death trap for a child.

General safety



- **WARNING** — This appliance is intended to be used in household and similar applications such as
 - staff kitchen areas in shops, offices and other working environments;
 - farm houses and by clients in hotels, motels and other residential type environments;
 - bed and breakfast type environments;
 - catering and similar non-retail applications.
 - **WARNING** — Do not store explosive substances such as aerosol cans with a flammable propellant in this appliance.
 - **WARNING** — If the supply cord is damaged, it must be replaced by the manufacturer, its service agent or similarly qualified persons in order to avoid a hazard.
 - **WARNING** — Keep ventilation opening, in the appliance enclosure or in the built-in structure, clear of obstruction.
 - **WARNING** — Do not use mechanical devices or other means to accelerate the defrosting process, other than those recommended by the manufacturer.
 - **WARNING** — Do not damage the refrigerant circuit.
 - **WARNING** — Do not use electrical appliances inside the food storage compartments of the appliance, unless they are of the type recommended by the manufacturer.
-

-
- **WARNING** — The refrigerant and insulation blowing gas are flammable. When disposing of the appliance, do so only at an authorized waste disposal centre. Do not expose to flame.
 - **WARNING** —When positioning the appliance, ensure the supply cord is not trapped or damaged.
 - **WARNING** —Do not locate multiple portable socket-outlets or portable power supplies at the rear of the appliance.
 - **WARNING** —Food needs to be packed in bags before putting into the refrigerator, and liquids need to be packed in bottles or capped containers to avoid the problem that the product design structure is not easy to clean.



The symbol  is a warning and indicates the refrigerant and insulation blowing gas are flammable.

Warning: Risk of fire / flammable materials

Replacing the illuminating lamps

- **WARNING**—The illuminating lamps must not be replaced by the user! If the illuminating lamps is damaged, contact the customer helpline for assistance.

This warning is only for refrigerators that contain illuminating lamps.

Refrigerant

The refrigerant isobutene (R600a) is contained within the refrigerant circuit of the appliance, a natural gas with a high level of environmental compatibility, which is nevertheless flammable. During transportation and installation of the appliance, ensure that none of the components of the refrigerant circuit becomes damaged.

The refrigerant (R600a) is flammable.

- **WARNING** — Refrigerators contain refrigerant and gases in the insulation. Refrigerant and gases must be disposed of professionally as they may cause eye injuries or ignition. Ensure that tubing of the refrigerant circuit is not damaged prior to proper disposal.

If the refrigerant circuit should be damaged:

- Avoid opening flames and sources of ignition.
- Thoroughly ventilate the room in which the appliance is situated.

It is dangerous to alter the specifications or modify this product in any way.

Any damage to the cord may cause a short circuit, fire, and/or electric shock.



Electrical safety

- 1.The power cord must not be lengthened.
2. Make sure that the power plug is not crushed or damaged. A crushed or damaged power plug may overheat and cause a fire.
3. Make sure that you can access the main plug of the appliance.
4. Do not pull the main cable.
5. If the power plug socket is loose, do not insert the power plug. There is a risk of electric shock or fire.
- 6.You must not operate the appliance without the interior lighting lamp cover.
- 7.The fridge is only applied with power supply of single phase alternating current of 220~240V/50Hz. If fluctuation of voltage in the district of user is so large that the voltage exceeds the above scope, for safety sake, be sure to apply A.C. automatic voltage regulator of more than 350W to the fridge. The fridge must employ a special power socket instead of common one with other electric appliances. Its plug must match the socket with ground wire.

Daily use

- Do not store flammable gases or liquids in the appliance, There is a risk of an explosion.
- Do not operate any electrical appliances in the appliance (e.g.electric ice cream makers,mixers etc.).
- When unplugging always pull the plug from the mains socket,do not pull on the cable.
- Do not place hot items near the plastic components of this appliance.

-
- Do not place food products directly against the air outlet on the rear wall.
 - Store pre-packed frozen food in accordance with the frozen food manufacture's instructions.
 - The appliances manufactures storage recommendations should be strictly adhered to relevant instructions for storage.
 - Do not place carbonated or fizzy drinks in the freeze compartment as it creates pressure on the container, which may cause it to explode, resulting in damage to the appliance.
 - Frozen food can cause frost burns if consumed straight from the freezer compartment.
 - Do not place the appliance in direct sunlight.
 - Keep burning candles, lamps and other items with naked flames away from the appliance so that do not set the appliance on fire.
 - The appliance is intended for keeping food stuff and/or beverages in normal household as explained in this instruction booklet. The appliance is heavy. Care should be taken when moving it.
 - Do not remove nor touch items from the freezer compartment if your hands are damp/wet, as this could cause skin abrasions or frost/freezer burns.
 - Never use the base, drawers, doors etc. to stand on or as supports.
 - Frozen food must not be refrozen once it has been thawed out.
 - Do not consume ice popsicles or ice cubes straight from the freezer as this can cause freezer burn to the mouth and lips.
 - To avoid items falling and causing injury or damage to the appliance, do not overload the door racks or put too much food in the crisper drawers.
 - **This refrigerating appliance is not intended to be used as a built-in appliance.**

Caution!

Care and cleaning

- Before maintenance, switch off the appliance and disconnect the mains plug from the mains socket.
- Do not clean the appliance with metal objects, steam cleaner, ethereal oils, organic solvents or abrasive cleansers.
- Do not use sharp objects to remove frost from the appliance. Use a plastic scraper.

Installation Important!

- For electrical connection carefully, follow the instructions given in this manual.
- Unpack the appliance and check if there are damages on it. Do not connect the appliance if it is damaged. Report possible damages immediately to the place you bought it. In this case retain packing.
- It is advisable to wait at least four hours before connecting the appliance to allow the oil to flow back in the compressor.
- Adequate air circulation should be around the appliance, lacking this leads to overheating. To achieve sufficient ventilation, follow the instructions relevant to installation.
- Wherever possible, the back of the product should not be too close to a wall to avoid touching or catching warm parts (compressor, condenser) to prevent the risk of a fire, follow the instructions relevant to installation.
- The appliance must not be located close to radiators or cookers.
- Make sure that the mains plug is accessible after the installation of the appliance.

Service

- Any electrical work required to do the servicing of the appliance should be carried out by qualified electrician or competent person.
- This product must be serviced by an authorized Service Center, and only genuine spare parts must be used.
 - 1)If the appliance is Frost Free.
 - 2)If the appliance contains freezer compartment.

Installing your new appliance

Before using the appliance for the first time, you should be informed of the following tips.

Ventilation of appliance



In order to improve efficiency of the cooling system and save energy, it is necessary to maintain good ventilation around the appliance for the dissipation of heat. For this reason, sufficient clear space should be available around the refrigerator. Suggest :It is advisable for there to be 50-70mm of space from the back to the wall, at least 100mm from its top, at least 100mm from its side to the wall and a clear space in front to allow the doors to open 135°. As shown in following diagrams.

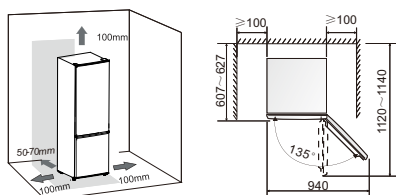

Note:

● This appliance performs well within the climate class from N to T showed in the table below.

It may not work properly if being left at a temperature above or below the indicated range for a long period.

Climate class	Ambient temperature
SN	+10°C to +32°C
N	+16°C to +32°C
ST	+16°C to +38°C
T	+16°C to +43°C

- Stand your appliance in a dry place to avoid high moisture.
- Keep the appliance out of direct sunlight, rain or frost. Stand the appliance away from heat sources such as stoves, fires or heaters.

Leveling of appliance

- For sufficient leveling and air circulating in the lower rear section of the appliance, the bottom rear feet may need to be adjusted. You can adjust them manually by hand or by using a suitable spanner.
- To allow the doors to self-close, tilt the top backwards by about 10mm.

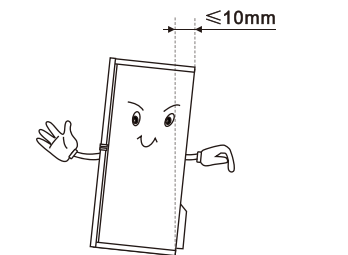

Description of the appliance

View of the appliance

- 1.Refrigerator lamp
- 2.Door switch
- 3.Shelf
- 4.Vegetable drawer cover
- 5.Vegetable drawer
- 6.Screw hole cover
- 7.Freezer upper drawer
- 8.Freezer lower drawer
- 9.Adjustable foot
- 10.Egg rack(inside)
- 11.Upper rack
- 12.Refrigerator door
- 13.Lower rack
- 14.Freezer door

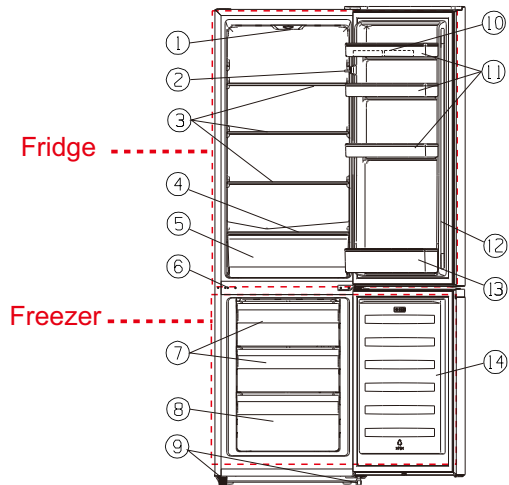





Note: Due to unceasing modification of our products, your refrigerator may be slightly different from this instruction manual, but its functions and using methods remain the same. To get more space in the freezer, you can remove drawers (except lower freezer drawer), install bracket and integrative ice maker/twistable ice tray.

Note: To get the best energy efficiency of this product, please place all shelves, drawers on their original position as the illustration above.

Reversing the door

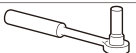
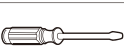
The side at which the door opens can be changed, from the right side (as supplied) to the left side, if required.
Warning! When reversing the door, the appliance must not be connected to the mains. Ensure that the plug is removed from the mains socket.

Tools you will need

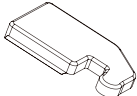
Not provided		
		
8mm socket wrench	Thin-blade screwdriver	Putty knife
		
Cross-shaped screwdriver	Monkey wrench	8mm wrench
Additional parts (in the plastic bag)		
		
Left Hinge Cover		

Note: If required, you may lay the refrigerator on its back in order to gain access to the base, you should rest it on soft foam packaging or similar material to avoid damaging the backboard of the refrigerator. To reverse the door, the following steps are generally recommended.

1. Stand the refrigerator upright. Open the upper door to take out all door racks (to avoid damage) and then close the door.

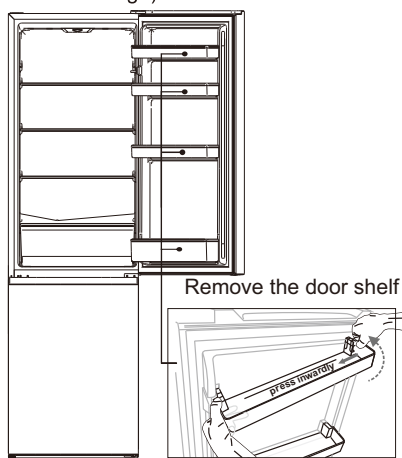

2. Use a putty knife or thin-blade screwdriver to prize the screw hole cover which is at the top left corner of the refrigerator, and the upper hinge cover which is at the top right corner of the refrigerator.

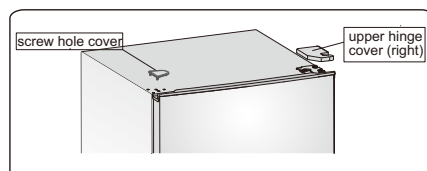

3. Unscrew the special flange self-tapping screws which are used for fixing the right upper hinge part by a 8mm socket driver or a spanner (please support the upper door with your hand when doing it).

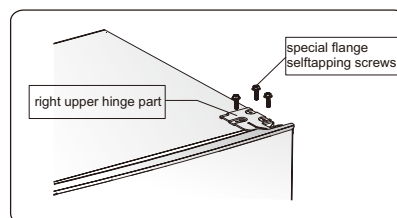

4. Remove the upper hinge axis, transfer it to reversed side and tighten securely, then put it in a safe place.

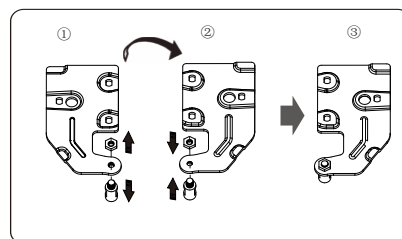

5. Remove the upper door from the middle hinge by carefully lifting the door straight up.

NOTE: When removing the door, watch for washer(s) between the center hinge and the bottom of the upper door that may stick to the door. Do not lose.

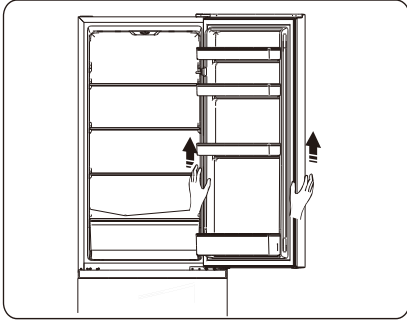

6. Place the upper door on a smooth surface with its panel upwards. Loose screw ② and part ①, then Install them to the left side and tighten

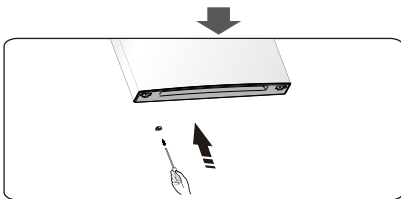
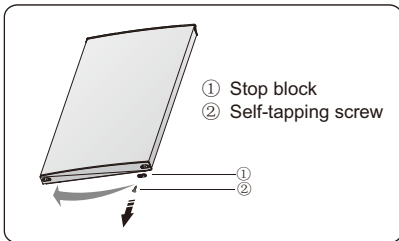

7. Unscrew the two special flange self-tapping screws which are used for fixing the middle hinge part, then remove the middle hinge part that hold the lower door in place.

NOTE: When removing the door, watch for washer(s) between the lower hinge and the bottom of the lower door that may stick to the door. Don't lose it.

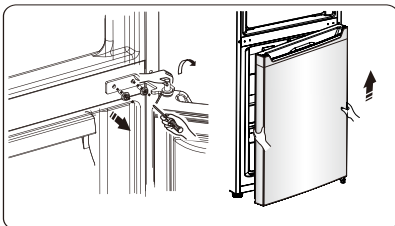

8. Place the lower door on a smooth surface with its panel upwards. Loose screw ② and part ①, then Install them to the left side and tighten securely.

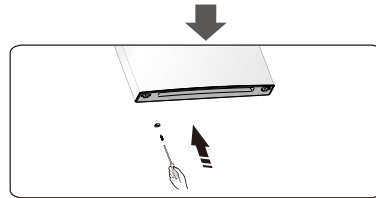
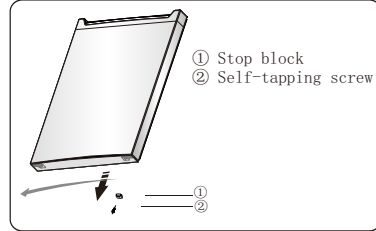

9. Change screw hole covers on middle cover plate from left to right (as shown in figure below).

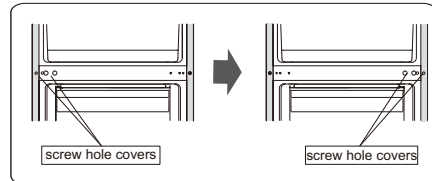

10. Lay the refrigerator on soft foam packaging or similar material. Remove both adjustable bottom feet parts, and remove the front feet board and the lower hinge part by unscrewing the special flange self-tapping screws.

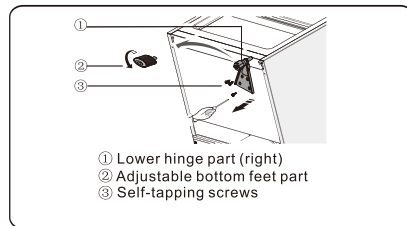

11. Replace the lower hinge part to the left side and fixing it with the special flange self-tapping screws. Replace the adjustable bottom feet parts to another side and fixing it.

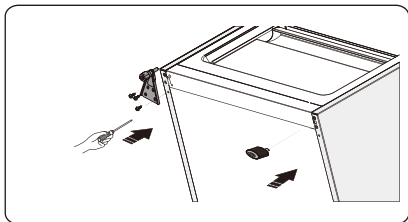

12. Transfer the lower door to the property position, adjust the lower hinge part, make the hinge axis into the lower hole of the lower door, then tight the bolts.

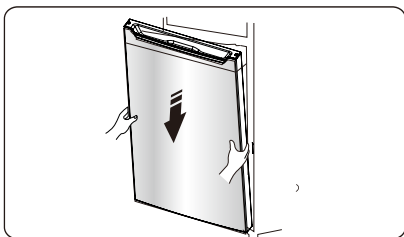

13. Upturn the middle hinge part the direction 180 degree, transfer it and adjust its position, make the middle hinge axis into the upper hole of the lower door, tight the bolts.

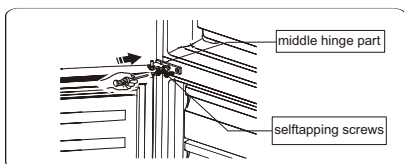

14. Transfer the upper door to the appropriate position. Secure the door's level, make the middle hinge axis into the lower hole of the upper door.

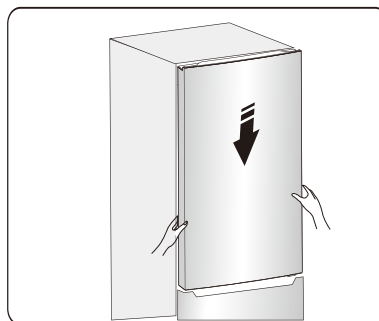

15. Transfer the upper hinge part and make the upper hinge axis into the upper hole of the upper door, and adjust the position of the upper door (please support the upper door with your hand when doing it), fixing the upper hinge part with the special flange self-tapping screws.

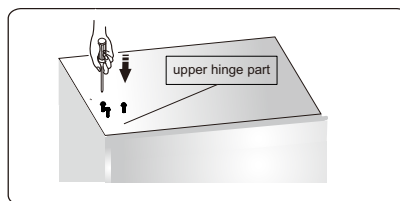

16. Install the screw hole cover on the top right corner of the refrigerator. Install the upper hinge cover (which is in the plastic bag) on the left corner. Put the other upper hinge cover into the plastic bag.

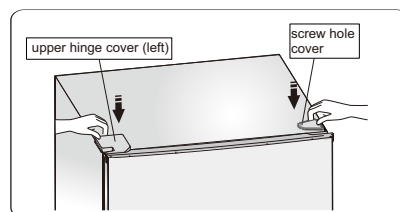

17. Open the upper door and install the door shelves, then close it.

Warning!

When changing the side at which the door opens, the appliance must not be connected to the mains. Remove plug from the mains beforehand.

Operation

Starting up and temperature regulation

- Insert the plug of the connection lead into the plug socket with protective earth contact. When the refrigerator compartment door is opened, the internal lighting is switched on. After the fridge has been placed in position, wait for 5 minutes before electricity is supplied. Don't store anything until the temperature inside the fridge becomes low enough.
- The temperature selector knob is located on the top of the refrigerator compartment.

Setting 0 means:

Off.

Clockwise rotate the knob to turn on the appliance

Setting 1 means:

Highest temperature, warmest setting.

Setting 7 (end-stop) means:

Lowest temperature, coldest setting.

Important! Normally we advise you select setting of 2 or 3 or 4, if you want the temperature higher or colder please turn the knob to warmer or colder setting accordingly. When you turn the knob to colder which can lead to the more energy efficiency. Otherwise, it would result in more energy-consuming.

NOTE: High temperature setting will accelerate food waste.

● For optimum food preservation, a medium setting is generally the most suitable.

Important! High ambient temperatures (e.g. on hot summer days) and a cold setting (position 6 to 7) may cause the compressor to run continuously or even non-stop!

Reason: when the ambient temperature is high, the compressor must run continuously to maintain the low temperature in the appliance

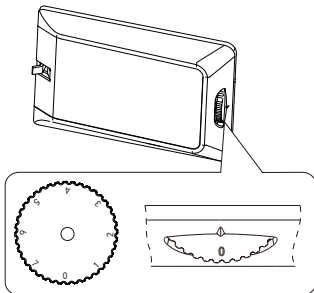

Changing the light bulb



Warning! If the LED light is damaged. DO NOT CHANGE IT BY THE USER!

Changing the LED light carried out by inexperienced persons may cause injury or serious malfunctioning. It must be replaced by a qualified person in order to avoid a hazard. Contact your local Service Force Center for help.

- Before changing the LED light, switch off the appliance and unplug it, or pull the fuse or the circuit breaker.
- LED Light data: 220-240 V, max. 1.5W.
- To switch off the appliance, set the temperature regulator to position "0".
- Unplug the mains plug.
- Press the Lampshade, and slide it backwards.
- To change the LED light, undo the screw.
- Remove the bulb fixed block, change the defective LED light.
- Refit the bulb fixed block, the LED light cover and the screw.
- Put the refrigerator back into operation.

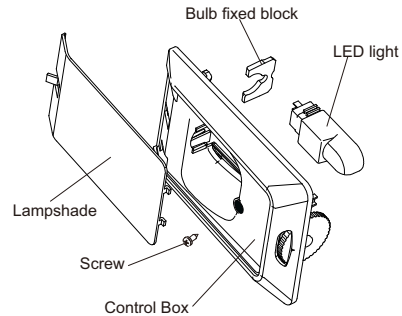

Using your appliance

Movable shelves/trays

- Various glass, plastic storage shelves or wire trays are included with your appliance-different models have different combinations and different models have different features.
- The walls of the refrigerator are equipped with a series of runners so that the shelves can be positioned as desired.

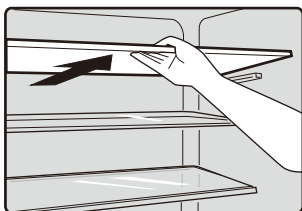

Remove and install the door shelf

Warning: The door shelf must not be removed and installed by the user! If the door shelf is damaged, contact the customer helpline for assistance. To replace the door shelf, the below steps can be followed:

Remove the door shelf



Press the right side of the door shelf inwardly, while holding the left side. When the notch of the shelf has been detached from the refrigerator door, remove the rack obliquely upwardly.

Install the door shelf

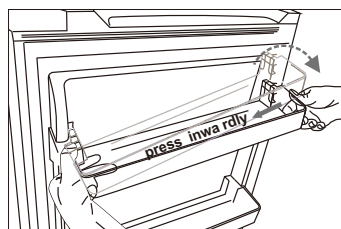

Firstly tilt the left side of the door shelf, and make sure the notch has been fastened to the door. Then press the right side inwardly. push it down to the right place.

Vegetable Drawer

- For storing fruit and vegetables.

Freezer Drawer

- For storing frozen food.

Ice-cube tray

- For making ice and storing ice-cubes.

Refrigerator compartment

- For storing food that does not need to be frozen and different sections suitable for different kinds of food.

Freezer food compartment

- For freezing fresh food and storing frozen and deep-frozen food for long periods of time.

Thawing food

- In the refrigerator compartment.
- At room temperature.
- In a microwave oven.
- In a conventional or convection oven.
- Food once thawed should not be

1) If the appliance contains related accessories and functions.

2) If the appliance contains a freezer compartment.

Helpful hints and tips

Energy saving tips

We recommend that you follow the tips below to save energy.

- Try to avoid keeping the door open for long periods in order to conserve energy.
- Ensure the appliance is away from any sources of heat (Direct sunlight, electric oven or cooker etc)
- Don't set the temperature colder than necessary.
- Don't store warm food or evaporating liquid in the appliance.
- Place the appliance in a well ventilated, humidity free, room. Please refer to Installing your new appliance chapter.
- If the diagram shows the correct combination for the drawers, crisper and shelves, do not adjust the combination as this is designed to be the most energy efficient configuration.

Hints for fresh food refrigeration

- Do not place hot food directly into the refrigerator or freezer, the internal temperature will increase resulting in the compressor having to work harder and will consume more energy.
- Do cover or wrap the food, particularly if it has a strong flavor.
- Place food properly so that air can circulate freely around it.

Hints for refrigeration

- Meat (All Types) wrap in polythene food: wrap and place on the glass shelf above the vegetable drawer. Always follow food storage times and use by dates suggested by manufacturers.
- Cooked food, cold dishes, etc.: They should be covered and may be placed on any shelf.
- Butter and cheese: Should be wrapped in airtight foil or plastic film wrap.
- Milk bottles: Should have a lid and be stored in the door racks.

Hints for freezing

- When first starting-up or after a period out of use, let the appliance run at least 2 hours on the higher settings before putting food in the compartment.
- Prepare food in small portions to enable it to be rapidly and completely frozen and to make it possible to subsequently thaw only the quantity required.
- Wrap up the food in aluminum foil or polyethylene food wraps which are airtight,
- Do not allow fresh, unfrozen food to touch the food which is already frozen to avoid temperature rise of the latter.
- Iced products, if consumed immediately after removal from the freezer compartment, will probably cause frost burns to the skin.
- It is recommended to label and date each frozen package in order to keep track of the storage time.

Hints for the storage of frozen food

- Ensure that frozen food has been stored correctly by the food retailer
- Once defrosted, food will deteriorate rapidly and should not be re-frozen. Do not exceed the storage period indicated by the food manufacturer.

Switching off your appliance

If the appliance needs to be switched off for an extended period, the following steps should be taken prevent mould on the appliance.

1. Remove all food.
2. Remove the power plug from the mains socket.
3. Clean and dry the interior thoroughly.
4. Ensure that all the doors are wedged open slightly to allow air to circulate.

Cleaning and care

For hygienic reasons the appliance (including exterior and interior accessories) should be cleaned regularly at least every two months.

Caution! The appliance must not be connected to the mains during cleaning. Danger of electrical shock! Before cleaning switch the appliance off and remove the plug from the mains socket.

Exterior cleaning

To maintain good appearance of your appliance, you should clean it regularly.

-Wipe the digital panel and display panel with a clean, soft cloth.

-Spray water onto the cleaning cloth instead of spraying directly on the surface of the appliance. This helps ensure an even distribution of moisture to the surface.

-Clean the doors, handles and cabinet surfaces with a mild detergent and then wiped dry with a soft cloth.

Caution!

-Don't use sharp objects as they are likely to scratch the surface.

-Don't use thinner, car detergent, clorox, ethereal oil, abrasive cleansers or organic solvent such as Benzene for cleaning. They may damage the surface of the appliance and may cause fire.

Interior cleaning

You should clean the appliance interior regularly. It will be easier to clean when food stocks are low. Wipe the inside of the fridge freezer with a weak solution of bicarbonate of soda, and then rinse with warm water using a wrung-out sponge or cloth. Wipe completely dry before replacing the shelves and baskets.

Thoroughly dry all surfaces and removable parts.

A layer of frost may occur on the freezer compartment's interior walls if the freezer door is opened frequently or kept open too long. If the frost is too thick, choose a time when the supply of food stocks are low and proceed as follows:

1. Remove existing food and accessories baskets, unplug the appliance from the mains power and leave the doors open. Ventilate the room thoroughly to accelerate the thawing process.

2. When defrosting is completed, clean your freezer as described above.

Caution! Don't use sharp objects to remove frost from the freezer compartment. Only after the interior is completely dry should the appliance be switched back on and plugged back into the mains socket.

Door seals cleaning

Take care to keep door seals clean. Sticky food and drinks can cause seals to stick to the cabinet and tear when you open the door. Wash seal with a mild detergent and warm water. Rinse and dry it thoroughly after cleaning.

Caution! Only after the door seals are completely dry should the appliance be powered on.

Defrosting

Why defrosting

- Water contained in food or getting into air inside the fridge by opening doors may form a frost layer inside. It will weaken the refrigeration when the frost is thick. While it is more than 10mm thick, you should defrost.

Defrosting in fresh food storage compartment

- It is automatically controlled by switching the temperature regulator on or off so that there is no need of operation of defrosting. Water from defrosting will be drained into a drip tray through a drain pipe at the back of the fridge automatically.

Defrosting in frozen-food storage compartment

- Defrosting in freezer chamber is operated manually. Before defrosting, take the food out.
- Take the ice tray and food in drawers out or put them into the fresh food compartment temporarily.
- Set the knob of the temperature regulator to position "0" (where the compressor will stop working) and leave the door of the refrigerator open until ice and frost

dissolve thoroughly and accumulation at the bottom of the freezer chamber. Wipe off the water with soft cloth.

- In the case of speeding up the process of defrosting, you may put a bowl of warm water (about 50°C) into the freezer chamber, and scrape away the ice and frost with a defrosting spatula. After doing so, be sure to set the knob of the temperature regulator to the original position.
- It is not advisable to heat the freezer chamber directly with hot water or hair dryer while defrosting to avoid deformation of the inner case.
- It is also not advisable to scrape off ice and frost or separate food from the containers which have been congealed together with the food with sharp tools or wooden bars, so as not to damage the inner casing or the surface of the evaporator.

Warning! Switching off the appliance before defrosting, turn the temperature regulator to position "0".

Important! The fridge should be defrosted at least every one month. During the using process, if the door was opened frequently or using the appliance in the extreme humidity, we advise the user to defrost every two weeks.

Go out of use for a long time

- Remove all refrigerated packages.
- Switch off the appliance by turning the temperature regulator to position "0".
- Remove the mains plug or switch off or disconnect the electricity supply.
- Clean thoroughly (see section: Cleaning and Care)
- Leave the door open to avoid the build up of odors.

Note: If the appliance contains freezer compartment

Troubleshooting

If you experience a problem with your appliance or are concerned that the appliance is not functioning correctly, you can carry out some easy checks according to this section before calling for service.

Warning! Don't try to repair the appliance yourself. If the problem persists after you have made the checks mentioned below, contact a qualified electrician, authorized service engineer or the shop where you purchased the product.

Problem	Possible cause & Solution
Appliance is not working correctly	Check whether the power cord is plugged into the power outlet properly.
	Check the fuse or circuit of your power supply, replace if necessary.
	The ambient temperature is too low. Try setting the chamber temperature to a colder level to solve this problem.
Odours from the compartments	The interior may need to be cleaned
	Some food, containers or wrapping cause odours.
Noise from the appliance	The sounds below are quite normal: <ul style="list-style-type: none"> ● Compressor running noises. compartment or other compartments. ● Gurgling sound similar to water boiling. ● Popping noise during automatic defrosting. ● Clicking noise before the compressor starts.
	Other unusual noises are due to the reasons below and may need you to check and take action: <ul style="list-style-type: none"> ● The cabinet is not level. ● The back of appliance touches the wall. ● Bottles or containers fallen or rolling.
The motor runs continuously	It is normal to frequently hear the sound of the motor, it will need to run more when in following circumstances: <ul style="list-style-type: none"> ● Temperature setting is colder than necessary ● Large quantity of warm food has recently been stored within the appliance. ● The temperature outside the appliance is too high. ● Doors are kept open too long or too often. ● After your installing the appliance or it has been switched off for a long time.
A layer of frost occurs in the compartment	Ensure food is placed within the appliance to allow sufficient ventilation. Ensure that door is fully closed. To remove the frost, please refer to cleaning and care chapter.
Temperature inside is too warm	You may have left the doors open too long or too frequently; or the doors are kept open by some obstacle; or the appliance is located with insufficient clearance at the sides, back and top.

Temperature inside is too cold	Increase the temperature by following the "Display controls" chapter.
Doors cant be closed easily	Check whether the top of the refrigerator is tilted back by 10-15mm to allow the doors to self close, or if something inside is preventing the doors from closing.
Water drips on the floor	The water pan (located at the rear bottom of the cabinet) may not be properly leveled, or the draining spout (located underneath the top of the compressor depot) may not be properly positioned to direct water into this pan, or the water spout is blocked. You may need to pull the refrigerator away from the wall to check the pan and spout.
The light is not working	The light may be damaged. Refer to replace lights in operation chapter.

Disposal of the appliance

It is prohibited to dispose of this appliance as household waste.

Packaging materials

Packaging materials with the recycle symbol are recyclable. Dispose of the packaging into a suitable waste collection container to recycle it.

Before disposal of the appliance

1. Pull out the mains plug from the mains socket.
2. Cut off the power cord and discard with the mains plug.

Warning! Refrigerators contain refrigerant and gases in the insulation. Refrigerant and gases must be disposed of professionally as they may cause eye injuries or ignition.

Ensure that tubing of the refrigerant circuit is not damage prior to proper disposal.

	Correct Disposal of this product
	<p>This symbol on the product or in its packing indicates that this product may not be treated as household waste. Instead, it should be taken to the appropriate waste collection point for the recycling of electrical and electronic equipment. By ensuring this product is disposed of correctly, you will help prevent potential negative consequences for the environment and human health, which could otherwise be caused by the inappropriate waste handling of this product. For more detailed information about the recycling of this product, please contact your local council your household waste disposal service, or the shop where you purchased the product.</p>

To avoid contamination of food, please respect the following instructions

- Opening the door for long periods can cause a significant increase of the temperature in the compartments of the appliance.
- Clean regularly surfaces that can come in contact with food and accessible drainage systems.
- Clean water tanks if they have not been used for 48 h.
- Store raw meat and fish in suitable containers in the refrigerator, so that it is not in contact with or drip onto other food.
- Two-star frozen-food compartments are suitable for storing pre-frozen food, storing or making icecream and making ice cubes.
- One-, two- and three-star compartments are not suitable for the freezing of fresh food.
- If the refrigerating appliance is left empty for long periods, switch off, defrost, clean, dry, and leave the door open to prevent mould developing within the appliance.

Order	Compartments TYPE	Target storage temp.[°C]	Appropriate food
1	Fridge	+2 ~+8	Eggs, cooked food, packaged food, fruits and vegetables, dairy products, cakes, drinks and other foods are not suitable for freezing.
2	(***)*-Freezer	≤ -18	Seafood (fish, shrimp, shellfish), freshwater aquatic products and meat products (recommended for 3 months, the longer the storage time, the worse the taste and nutrition), suitable for frozen fresh food.
3	***-Freezer	≤ -18	Seafood (fish, shrimp, shellfish), freshwater aquatic products and meat products (recommended for 3 months, the longer the storage time, the worse the taste and nutrition), are not suitable for frozen fresh food.
4	** -Freezer	≤ -12	Seafood (fish, shrimp, shellfish), freshwater aquatic products and meat products (recommended for 2 months, the longer the storage time, the worse the taste and nutrition), are not suitable for frozen fresh food.
5	*-Freezer	≤ -6	Seafood (fish, shrimp, shellfish), freshwater aquatic products and meat products (recommended for 1 months, the longer the storage time, the worse the taste and nutrition), are not suitable for frozen fresh food.
6	0-star	-6 ~0	Fresh pork, beef, fish, chicken, some packaged processed foods, etc. (Recommended to eat within the same day, preferably no more than 3 days) . Partially encapsulated processed foods (non-freezable foods)
7	Chill	-2 ~+3	Fresh/frozen pork, beef, chicken, freshwater aquatic products, etc.(7 days below 0 °C and above 0 °C is recommended for consumption within that day, preferably no more than 2 days). Seafood (less than 0 for 15 days, it is not recommended to store above 0 °C)

8	Fresh Food	0 ~+4	Fresh pork, beef, fish, chicken, cooked food, etc. (Recommended to eat within the same day, preferably no more than 3 days)
9	Wine	+5 ~+20	red wine, white wine, sparkling wine etc.

Note: please store different foods according to the compartments or target storage temperature of your purchased products.

- If the refrigerating appliance is left empty for long periods, switch off, defrost, clean, dry, and leave the door open to prevent mould developing within the appliance.

Water dispenser cleaning (special for water dispenser products):

- Clean water tanks if they have not been used for 48 h; flush the water system connected to a water supply if water has not been drawn for 5 days.

Hisense

life reimagined

UPUTSTVO ZA UPOTREBU

Pre upotrebe ovog uređaja, molimo vas da temeljno pročitate ovo uputstvo i da ga zadržite za slučaj potrebe.

RD-35DC4SAB/CV2-002

Srpski

Sadržaj

Bezbednosne informacije i upozorenja	2	Upotreba uređaja	14
Instaliranje vašeg novog uređaja	8	Korisni saveti	15
Opis uređaja	9	Čišćenje i nega	16
Promena strane vrata	10	Otklanjanje problema	18
Rad uređaja	13	Odlaganje uređaja	19



Bezbednosne informacije i upozorenja

U cilju bezbedne i pravilne upotrebe, pre instaliranja i prve upotrebe uređaja, pažljivo pročitati ovo korisničko uputstvo, uključujući savete i upozorenja. Kako bi se izbegle nepotrebne greške i nezgode, važno je osigurati da su sve osobe koje koriste uređaj dobro upoznate sa njegovom upotrebom i sigurnosnim karakteristikama. Sačuvati ovo uputstvo i postarati se da ono prati uređaj ukoliko se uređaj premesti ili proda, kako bi se sve osobe koje će koristiti uređaj propisno informisale o njegovoj upotrebi i upoznale sa sigurnosnim napomenama. Iz razloga zaštite zdravlja i imovine, primenjivati mere predostrožnosti iz ovog uputstva za upotrebu jer proizvođač neće biti odgovoran za štetu nastalu usled propusta.

Bezbednost dece i ostalih ugroženih kategorija ljudi

- U skladu sa EN standardom

Ovaj uređaj mogu koristiti deca starija od 8 godina i osobe sa fizičkim, čulnim ili mentalnim invaliditetom kao i neiskusne osobe i osobe koje nisu upoznate sa upotrebom ovog uređaja, ukoliko to čine pod nadzorom ili prema datim smernicama i na bezbedan način i ukoliko su svesne povezanih opasnosti. Deci nije dozvoljeno da se igraju sa uređajem. Čišćenje i korisničko održavanje uređaja ne smeju obavljati deca bez nadzora.

Deca uzrasta od 3 do 8 godina mogu stavljati i uzimati hranu i druge proizvode iz rashladnih uređaja.

- U skladu sa IEC standardom

Ovaj uređaj nije predviđen za upotrebu od strane osoba (uključujući decu) sa smanjenim fizičkim, čulnim ili mentalnim sposobnostima, kao i neiskusnih osoba i osoba koje nisu upoznate sa upotrebom ovog uređaja, osim ukoliko to čine pod nadzorom ili prema smernicama za upotrebu uređaja datim od strane osobe odgovorne za njihovu bezbednost.

Deca bi trebalo da budu pod nadzorom kako bi se sprečilo njihovo igranje sa uređajem.

- Držati svu ambalažu van dohvata dece jer postoji rizik od gušenja.
- Ukoliko više nećete koristiti uređaj, isključiti ga iz struje, iseći strujni kabl (što bliže uređaju) i skinuti vrata, kako bi se sprečio strujni udar ili zatvaranje dece u frižideru tokom igre.
- Ukoliko se ovim uređajem, koji sadrži magnetne zaptivače na vratima, zameniti stariji uređaj koji sadrži ručicu sa oprugom na vratima ili poklopcu, obavezno onesposobiti ručicu sa oprugom pre odlaganja starog uređaja. To će sprečiti zaglavljivanje deteta u starom frižideru.

Opšta bezbednost



- **UPOZORENJE** — Ovaj uređaj je predviđen za upotrebu u domaćinstvu i sličnim primenama kao što su
 - kuhinja za radno osoblje u prodavnicama, kancelarijama i drugim radnim okruženjima;
 - farmerske kućice i za klijente u hotelima, motelima i drugim postavkama stambenog tipa;
 - objektima koji nude noćenje sa doručkom;
 - ugostiteljske i slične nemaloprodajne primene.
- **UPOZORENJE** — Ne držati eksplozivne supstance kao što su boce sa aerosolima sa zapaljivom sadržinom u ovom uređaju.
- **UPOZORENJE** — Ukoliko je strujni kabl oštećen, mora se zameniti od strane proizvođača, njegovog ovlašćenog servisera ili drugih kvalifikovanih lica kako bi se izbegla opasnost.
- **UPOZORENJE** — Ukloniti sve prepreke sa otvora za ventilaciju u kućištu uređaja ili u objektu u kom se uređaj koristi.
- **UPOZORENJE** — Ne koristiti mehaničke uređaje ili druga sredstva za ubrzavanje procesa odmrzavanja, osim onih koje preporučuje proizvođač.
- **UPOZORENJE** — Čuvati kolo sa rashladnim sredstvom od oštećenja.
- **UPOZORENJE** — Ne koristiti električne uređaje unutar odeljaka za skladištenje hrane u uređaju, osim ukoliko su odobreni od strane proizvođača.

-
- UPOZORENJE — Rashladno sredstvo i izolacioni gas su zapaljivi. Pri odlaganju uređaja, to učiniti isključivo u ovlašćenom centru za odlaganje otpada. Ne izlagati otvorenom plamenu.
 - UPOZORENJE — Pri pozicioniranju uređaja, uveriti se da strujni kabl nije zaglavljen ili oštećen.
 - UPOZORENJE — Ne postavljati produžne kablove ili prenosive izvore napajanja sa zadnje strane uređaja.
 - UPOZORENJE — Hrana se mora spakovati u kesice pre stavljanja u frižider a tečnosti se moraju staviti u flaše ili posude sa poklopcem kako bi se izbegli problemi jer konstrukcija proizvoda nije laka za čišćenje.



- Simbol  predstavlja upozorenje i ukazuje na to da su rashladno sredstvo i izolacioni gas zapaljivi.

Upozorenje: Rizik od požara/zapaljivih materijala

Zamena lampica za osvetljenje

- UPOZORENJE — Lampice za osvetljenje se ne smeju menjati od strane korisnika! Ukoliko dođe do oštećenja lampica za osvetljenje, kontaktirati korisničku službu za pomoć.

Ovo upozorenje važi samo za frižidere koji su opremljeni lampicama za osvetljenje.

Rashladno sredstvo

Rashladni izobutan (R600a) se nalazi u rashladnom kolu uređaja i predstavlja prirodni gas sa visokim nivoom kompatibilnosti sa prirodnom sredinom, ali je zapaljiv. Tokom transporta i instalacije uređaja, sprečiti oštećivanje bilo koje komponente kola sa rashladnim sredstvom.

Rashladno sredstvo (R600a) je zapaljivo.

- UPOZORENJE — Frižideri sadrže rashladno sredstvo i gasove u izolaciji. Rashladno sredstvo i gasovi se moraju odlagati na stručan način jer mogu izazvati povrede očiju ili se mogu zapaliti. Uveriti se da cevi kola sa rashladnim sredstvom nisu oštećene pre pravilnog odlaganja.

Ukoliko dođe do oštećenja kola sa rashladnim sredstvom:

-
- Izbegavati otvorene plamenove i izvore vatre.
 - Dobro provetriti prostoriju u kojoj se nalazi uređaj.
- Opasno je menjati specifikacije ili modifikovati ovaj proizvod na bilo koji način.
- Bilo koje oštećenje kabla može izazvati kratak spoj, požar i/ili strujni udar.



Električna bezbednost

1. Strujni kabl se ne sme produžavati.
2. Uveriti se da utikač nije prignječen ili oštećen. Prignječen ili oštećen utikač se može pregrejati i izazvati požar.
3. Uveriti se da je omogućen pristup glavnom utikaču uređaja.
4. Ne vući glavni strujni kabl.
5. Ukoliko je utičnica labava, ne uključivati strujni utikač. Postoji rizik od strujnog udara ili požara.
6. Uređaj se ne sme koristiti ukoliko fali poklopac unutrašnje lampice za osvetljenje.
7. Frižider se može napajati isključivo jednofaznom naizmjeničnom strujom od 220~240V/50Hz. Ukoliko je fluktuacija napona u mestu korisnika toliko velika da napon prelazi gorenavedeni opseg, iz razloga bezbednosti obavezno povezati frižider na automatski regulator naizmjeničnog napona, čija je snaga veća od 350W. Frižider mora koristiti posebnu utičnicu a ne utičnicu koju deli sa drugim električnim uređajima. Žice za uzemljenje na utikaču frižidera i na utičnici se moraju poklapati.

Svakodnevna upotreba

- Ne držati zapaljive gasove ili tečnosti u uređaju. Postoji rizik od eksplozije.
- Ne koristiti bilo koje električne uređaje u uređaju (npr. električne aparate za sladoled, miksera, itd.).
- Prilikom isključivanja iz struje uvek najpre izvući utikač iz utičnice a ne vući za kabl.
- Ne postavljati vruće predmete blizu plastičnih komponenti ovog uređaja.

-
- Ne postavljati prehrambene proizvode direktno uz odvod za vazduh na zadnjoj strani.
 - Prethodno upakovane zamrznute namirnice držati u skladu sa smernicama proizvođača za zamrznutu hranu.
 - Preporuke za skladištenje koje je definisano proizvođač uređaja se moraju strogo poštovati.
 - Ne stavljati gazirana pića ili sokove u odeljak za zamrzavanje jer se stvara pritisak u boci, koji može izazvati njeno pucanje i oštećenje uređaja.
 - Zamrznuta hrana može izazvati promrzline ukoliko se konzumira direktno iz odeljka za zamrzavanje.
 - Ne izlagati uređaj direktnoj sunčevoj svetlosti.
 - Držati sveće, lampe i ostale predmete sa otvorenim plamenom dalje od uređaja kako se uređaj ne bi zapalio.
 - Uređaj je predviđen za držanje namirnica i/ili pića u normalnom domaćinstvu kao što je opisano u ovom uputstvu. Uređaj je težak. Potrebno je biti oprezan pri premeštanju uređaja.
 - Ne uklanjati niti dodirivati predmete iz odeljka za zamrzavanje ukoliko su vam ruke vlažne/mokre, jer to može izazvati nagrizanje kože ili promrzline.
 - Nikada ne koristiti osnovu, fijeke, vrata, itd., za stajanje na njima ili kao oslonac.
 - Zamrznuta hrana se ne sme ponovo zamrzavati nakon otapanja.
 - Ne konzumirati ledene lizalice ili kockice leda direktno iz zamrzivača jer mogu izazvati promrzline u ustima i na usnama.
 - Kako bi se izbeglo ispadanje predmeta i izazivanje fizičke povrede ili oštećenja uređaja, ne preopterećivati police na vratima niti stavljati previše hrane u fijeke za održavanje svežine.
 - **Ovaj rashladni uređaj nije predviđen za upotrebu kao ugradni uređaj.**

Oprez!

Nega i čišćenje

- Pre održavanja, isključiti uređaj i izvaditi glavni utikač iz utičnice.
- Ne čistiti uređaj metalnim predmetima, paročistačima, eteričnim uljima, organskim razređivačima ili abrazivnim sredstvima za čišćenje.
- Ne koristiti oštre predmete za uklanjanje leda sa uređaja. Koristiti plastični strugač.

Važno za instalaciju!

- U vezi sa električnim povezivanjem pažljivo pratiti smernice iz ovog uputstva.
- Otpakovati uređaj i proveriti da na njemu nema oštećenja. Ne povezivati uređaj ukoliko je oštećen. Sve moguće štete odmah prijaviti tamo gde ste kupili uređaj. U ovom slučaju zadržati ambalažu.
- Savetuje se da se sačeka najmanje četiri sata pre povezivanje uređaja kako bi se omogućilo vraćanje ulja u kompresor.
- Potrebno je obezbediti adekvatnu cirkulaciju vazduha oko uređaja, jer u suprotnom može doći do pregrevanja. Kako bi se postigla dovoljna ventilacija, pratiti smernice vezane za instalaciju.
- Gde je to moguće zadnja strana proizvoda ne bi trebalo da bude preblizu zida kako bi se izbeglo dodirivanje ili hvatanje za vruće delove (kompresor, kondenzator) kako bi se sprečio rizik od požara; poštovati smernice vezane za instalaciju.
- Uređaj se ne sme postavljati blizu radijatora ili šporeta.
- Uveriti se da je strujni utikač pristupačan nakon instaliranja uređaja.

Servis

- Sve električne radove koji su potrebni za servisiranje uređaja bi trebalo da obavi kvalifikovani električan ili stručno lice.
- Ovaj proizvod se mora servisirati od strane ovlašćenog servisa i moraju se koristiti isključivo originalni rezervni delovi.
 - 1) Ukoliko je uređaj Frost Free (sprečava formiranje leda).
 - 2) Ukoliko uređaj sadrži odeljak za zamrzavanje

Instaliranje vašeg novog uređaja

Pre prve upotrebe uređaja, potrebno je upoznati se sa sledećim savetima.

Ventilacija uređaja

Kako bi se unapredila efikasnost rashladnog sistema i uštedela energija, neophodno je omogućiti dobru ventilaciju oko uređaja u svrhu disipacije toplote. Iz ovog razloga je potrebno ostaviti dovoljno slobodnog prostora oko frižidera. Savetuje se ostavljanje prostora od 50-70mm od zadnje strane do zida, najmanje 100mm od gornje strane, najmanje 100mm od bočnih strana do zida i slobodan prostor ispred uređaja kako bi se omogućilo otvaranje vrata do 135°. Kao što je prikazano na sledećim dijagramima.

- Postavite vaš uređaj na suvo mesto kako bi se izbeglo oštećenje od vlage.

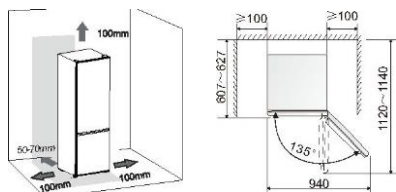

Napomena:

- Ovaj uređaj dobro radi u klimatskoj klasi od N do T koje su prikazane u tabeli u nastavku.

Možda neće raditi kako treba ukoliko se duže vreme ostavi na temperaturi višoj ili nižoj od prikazanog opsega.

Klimatska klasa	Temperatura sredine
SN	+10°C do +32°C
N	+16°C do +32°C
ST	+16°C do +38°C
T	+16°C do +43°C

- Držati uređaj dalje od direktne sunčeve svetlosti, kiše ili mraza. Postaviti uređaj dalje od izvora toplote kao što su šporeti, kamini ili grejalice.

Nivelisanje uređaja

- Kako bi se obavilo pravilno nivelisanje i omogućila cirkulacija vazduha u donjem zadnjem delu uređaja, možda će biti neophodno podesiti nožice. Mogu se podesiti ručno ili pomoću odgovarajućeg ključa
- Kako bi se omogućilo samostalno zatvaranje vrata, nagnuti gornji deo unazad za oko 10mm.

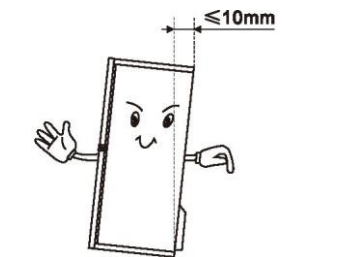

Opis uređaja

Izgled uređaja

1. Lampica frižidera
2. Prekidač na vratima
3. Polica
4. Poklopac fijke za povrće
5. Fijoka za povrće
6. Poklopac rupe za vijak
7. Gornja fijoka zamrzivača
8. Donja fijoka zamrzivača
9. Podesiva nožica
10. Polica za jaja (unutra)
11. Gornja polica
12. Vrata frižidera
13. Donja polica
14. Vrata zamrzivača

Frižider

Zamrzivač

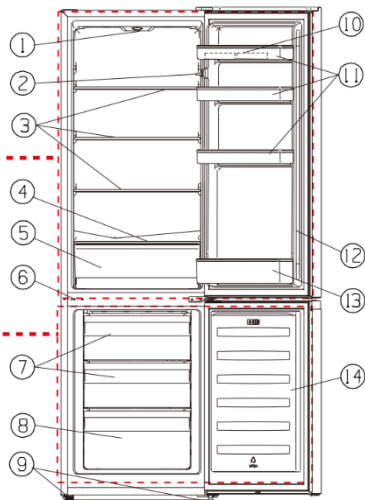

Napomena: Usled neprekidnog razvoja naših proizvoda, izgled vašeg frižidera se može donekle razlikovati od primera iz ovog uputstva, ali njegove funkcije i metode upotrebe ostaju isti. Kako biste dobili više prostora u zamrzivaču, možete izvaditi fijke (osim donje fijke zamrzivača), nosač za montažu i integrisani ledomat/posuda za led na izvrtanje.

Napomena: Kako bi se postigla najbolja energetska efikasnost ovog proizvoda, molimo vas da sve police i fijke postavite u njihov predviđen položaj kao što je prikazano na ilustraciji iznad.

Promena strane vrata

Strana na koju se vrata otvaraju se može promeniti, sa desne strane (u isporučenom stanju) na levu stranu, ukoliko je potrebno. Upozorenje! Prilikom promene strane vrata, uređaj ne sme biti uključen u struju. Uveriti se da je utikač izvađen iz utičnice.

Alati koji su vam potrebni

Ne dolaze uz uređaj		
		
račna sa nasadnom glavom od 8mm	Odvijač sa ravnim vrhom	Špahtla
		
Odvijač sa krstastim vrhom	Vodoinstalaterska klešta	Ključ od 8mm
Dodatni delovi (u plastičnoj vrećici)		
		
Poklopac leve šarke		

Napomena: Ukoliko je potrebno možete oboriti frižider na zadnju stranu kako biste imali bolji pristup osnovi, trebalo bi da ga naslonite na materijal od meke pene ili sličan materijal kako bi se izbeglo oštećivanje zadnje table frižidera. Za promenu strane vrata, preporučuju se sledeći koraci.

1. Postaviti frižider uspravno. Otvoriti gornja vrata kako biste uklonili sve police sa vrata (kako bi se izbeglo njihovo oštećivanje) pa zatim zatvoriti vrata.

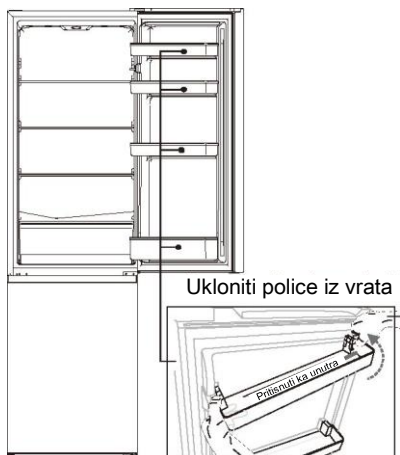

Ukloniti police iz vrata

2. Pomoću špahtle ili odvijača sa ravnim vrhom ukloniti poklopac rupe za vijak koji se nalazi u gornjem levom uglu frižidera i poklopac gornje šarke koji se nalazi u gornjem desnom uglu frižidera.

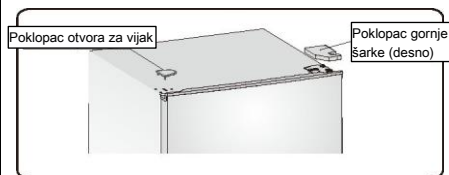

3. Odšrafiti specijalne samourezne vijke koji se koriste za fiksiranje desne gornje šarke pomoću račne sa nasadnom glavom od 8mm ili ključa (molimo vas da gornji deo vrata pridrđavate rukom tokom ovog koraka).

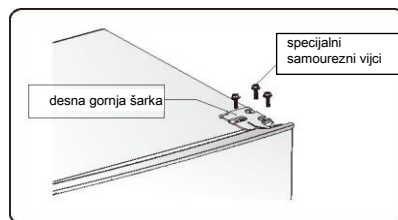

4. Ukloniti osovinicu gornje šarke, preneti je na suprotnu stranu i čvrsto zategnuti, zatim je zaštititi.

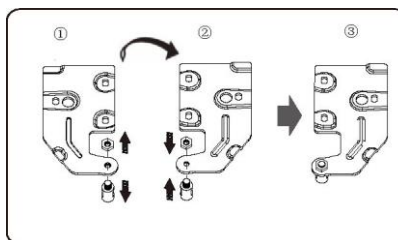

5. Skinuti gornja vrata sa srednje šarke pažljivo podižući vrata nagore.

NAPOMENA: Prilikom uklanjanja vrata, voditi računa o podloškama između središnje šarke i donjeg dela vrata jer se mogu zalepiti za vrata. Voditi računa da se ne izgube.

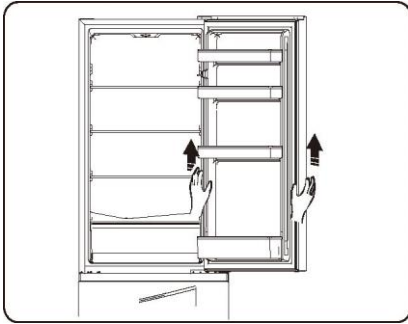

6. Postaviti gornja vrata na ravnu površinu tako da je spoljašnja strana okrenuta nagore. Odšrafiti vijak ② i deo ① pa ih zatim postaviti na levu stranu i zategnuti.

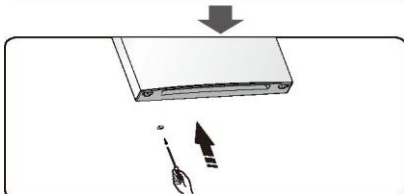

7. Odšrafiti dva specijalna samourezna vijka koji se koriste za pričvršćivanje središnje šarke, zatim ukloniti srednju šarku koja drži donja vrata.

NAPOMENA: Prilikom uklanjanja vrata, voditi računa o podloškama između donje šarke i donjeg dela vrata jer se mogu zalepiti za vrata. Paziti da se ne izgube.

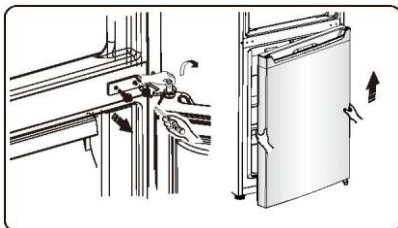

8. Postaviti donja vrata na ravnu površinu tako da je spoljašnja strana okrenuta nagore. Odšrafiti vijak ② i deo ① pa ih zatim postaviti na levu stranu i čvrsto zategnuti.

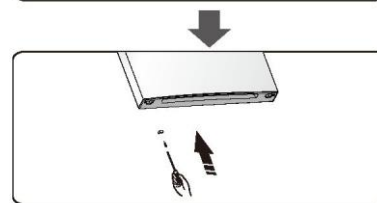

9. Zameniti poklopce za rupe za vijke na središnjoj tabli sa leve na desnu stranu (kao što je prikazano na slici u nastavku).

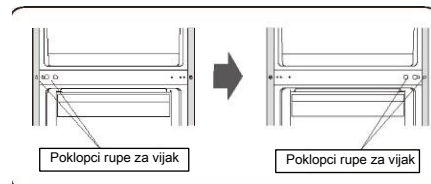

10. Postaviti frižider na materijal od meke pene ili sličan materijal. Ukloniti obe podesive nožice i ukloniti prednju donju tablu i donju šarku odvijanjem specijalnih samoureznih vijaka.

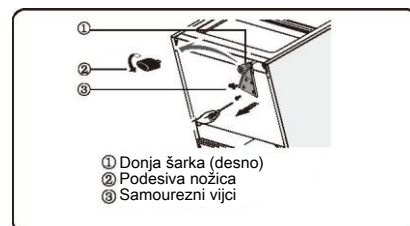

11. Premestiti donju šarku na levu stranu i pričvrstiti je specijalnim samoureznim vijcima. Prebaciti podesive nožice na drugu stranu i pričvrstiti ih.

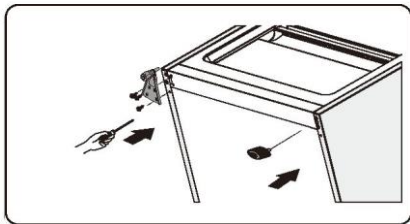

12. Postaviti donja vrata u odgovarajući položaj, podesiti donju šarku, postaviti osovnicu šarke u donji otvor na donjim vratima, pa zatim zategnuti vijke.

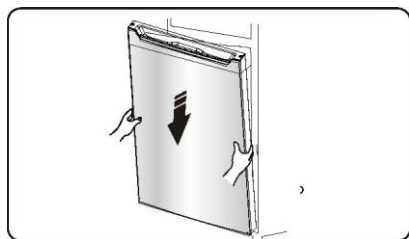

13. Okrenuti srednju šarku za 180 stepeni, preneti je i podesiti njen položaj, postaviti osovnicu srednje šarke u gornji otvor na donjim vratima, zategnuti vijke.

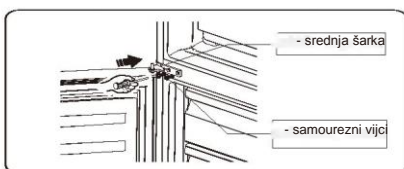

14. Preneti gornja vrata u predviđeni položaj. Pričvrstiti ručicu vrata, postaviti osovnicu srednje šarke u donji otvor na gornjim vratima.

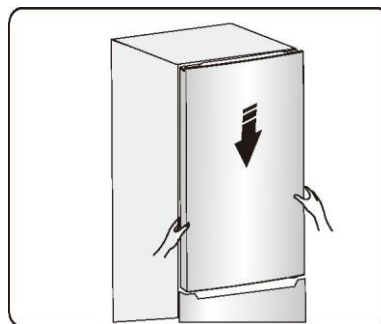

15. Preneti gornju šarku i postaviti osovnicu gornje šarke u gornji otvor na gornjim vratima i podesiti položaj gornjih vrata (molimo pridržavajte gornja vrata rukom kada to radite), pričvrstiti gornju šarku specijalnim samoureznim vijcima.

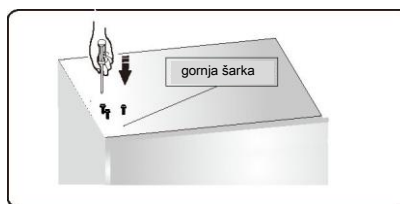

16. Postaviti poklopac rupe za vijke na gornji desni ugao frižidera. Postaviti poklopac gornje šarke (koji je u plastičnoj vrećici) na levi ugao. Staviti drugi poklopac za gornju šarku u plastičnu vrećicu.

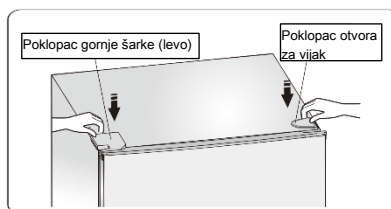

17. Otvoriti gornja vrata i postaviti police za vrata, zatim zatvoriti.

Upozorenje!

Prilikom promene strane na koju se vrata otvaraju, uređaj ne sme biti uključen u struju. Prethodno izvaditi utikač iz utičnice.

Rad uređaja

Uključivanje i regulacija temperature

- Povezati utikač na kraju strujnog kabela u utičnicu sa zaštitnim uzemljenjem. Kada se vrata komore frižidera otvore, unutrašnje svetlo se uključuje. Nakon što se frižider postavi u željeni položaj, sačekati 5 minuta pre uključivanja u struju. Ne stavljati ništa u frižider pre nego što se temperatura unutar frižidera ne spusti dovoljno.
- Dugme za odabir temperature se nalazi na vrhu komore frižidera.

Postavka 0 znači:

Isključeno.

Okrenuti dugme u smeru kazaljke na satu kako bi se uređaj uključio

Postavka 1 znači:

Najviša temperatura, najtoplija postavka.

Postavka 7 (krajnja tačka) znači:

Najniža temperatura, najhladnija postavka.

Važno! Obično savetujemo da izaberete postavku 2, 3 ili 4, a ukoliko želite višu ili nižu temperaturu okrenite dugme na topliju ili hladniju postavku. Kada okrenete dugme na hladnije to može dovesti do veće energetske efikasnosti. U suprotnom, rezultovaće većom potrošnjom energije.

NAPOMENA: Podešena visoka temperatura će ubrzati propadanje hrane.

- **Za optimalno čuvanje hrane, srednja postavka je generalno najpodesnija.**

Važno! Visoke temperature u okruženju (npr. tokom toplih letnjih dana) i hladna postavka na regulatoru temperature (položaj 6 do 7) mogu izazvati dugotrajan ili čak neprekidan rad kompresora! Razlog: kada je temperatura sredine visoka, kompresor mora raditi neprekidno kako bi se održala niska temperatura u uređaju.

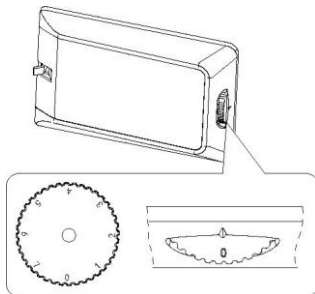

Zamena sijalice



Upozorenje! Ukoliko je LED sijalica oštećena.

ZAMENU SIJALICE NE SME OBAVLJATI KORISNIK!

Zamena LED sijalice koju obavljaju neiskusna lica može izazvati povredu ili ozbiljan kvar. Zamenu mora obaviti stručno lice kako bi se izbegla bilo kakva opasnost. Kontaktirajte vaš lokalni Servis za pomoć.

- Pre zamene LED sijalice, isključiti uređaj i izvaditi utikač iz utičnice, ili isključiti osigurač ili sklopku.
- Podaci o LED sijalici: 220-240 V, max. 1,5W.
- Kako bi se isključio uređaj, regulator temperature postaviti u položaj "0".
- Isključiti uređaj iz struje.
- Pritisnuti poklopac sijalice i gurnuti ga unazad.
- Kako biste zamenili LED sijalicu, skinuti vijak.
- Izvaditi fiksni blok sijalice, zameniti neispravnu LED sijalicu.
- Postaviti fiksni blok sijalice, poklopac LED sijalice i vijak.
- Uključiti frižider.

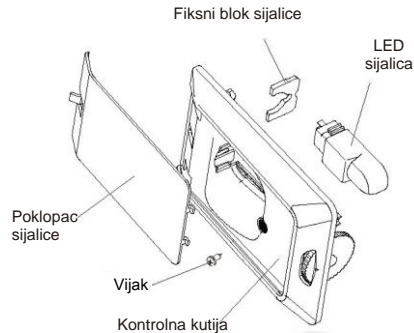

Upotreba vašeg uređaja

Prenosive police/fijoke

- Vaš aparat sadrži različite staklene, plastične police ili fijoke za čuvanje hrane—različiti modeli imaju različite kombinacije i različite karakteristike.
- Zidovi frižidera su opremljeni nizom klizača tako da se police mogu postaviti prema preferencijama korisnika.



Uklanjanje i montaža policia na vratima

Upozorenje: Polica na vratima se ne sme uklanjati i montirati od strane korisnika! Ukoliko dođe do oštećenja police u vratima, kontaktirati korisničku službu za pomoć. Za zamenu police u vratima obaviti korake opisane u nastavku:

Skidanje police za vrata



Pritisnuti desnu stranu police na vratima ka unutra, uz istovremeno držanje leve strane. Kada je jezičak na polici izašao iz vrata frižidera, ukloniti policu ukoso i nagore.

Montaža police za vrata

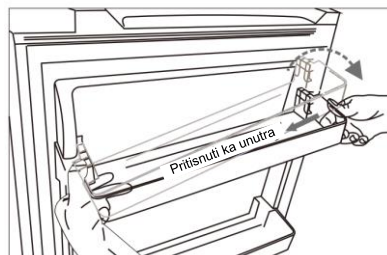

Najpre nagnuti levu stranu police i uveriti se da je jezičak postavljen u vrata. Zatim pritisnuti desnu stranu ka unutra i gurnuti je nadole dok ne legne u predviđeni položaj.

Fijoka za povrće

- Za čuvanje voća i povrća.

Fijoka za zamrzavanje

- Za čuvanje zamrznute hrane.

Polica za kockice leda

- Za pravljenje leda i čuvanje kockica leda.

Komora frižidera

- Za čuvanje hrane koju nije potrebno zamrzavati u različitim odeljcima koji su podesni za različite vrste hrane.

Odeljak za zamrzavanje hrane

- Za zamrzavanje sveže hrane i čuvanje zamrznutih i duboko zamrznutih namirnica duže vreme.

Odmrzavanje namirnica

- U komori frižidera.
- Na sobnoj temperaturi.
- U mikrotalasnoj pećnici.
- U konvencionalnoj ili konvekcijskoj retni.

Odmrznutu hranu ne bi trebalo ponovo zamrzavati.

- 1) Ukoliko uređaj sadrži pripadajuću prateću opremu i funkcije.
- 2) Ukoliko uređaj sadrži odeljak za zamrzavanje.

Korisni saveti

Saveti za uštedu energije

Preporučujemo da poštujuete savete koji su dati u nastavku kako biste uštedeli struju.

- Izbegavati duže otvaranje vrata kako bi se uštedela energija.
- Uverite se da su uređaji daleko od svih izvora toplote (direktna sunčeva svetlost, električna rerna ili šporet, itd.)
- Ne podešavati nižu temperaturu nego što je to potrebno.
- Ne stavljati toplu hranu ili tečnosti koje isparavaju u uređaj.
- Postaviti uređaj u dobro provetrenu prostoriju bez vlage. Pročitati poglavlje Instaliranje vašeg novog uređaja.
- Ukoliko dijagram pokazuje tačan raspored fijoka, odeljka za održavanje svežine i police, ne menjati takvu kombinaciju jer je projektovana tako da omogući najveće uštede energije.

Saveti za čuvanje sveže hrane

- Ne stavljati vrelu hranu direktno u frižider ili zamrzivač, unutrašnja temperatura će se povećati što je uzrokovati neprekidan rad kompresora i veću potrošnju struje.
- Pokriti ili obmotati hranu, naročito ukoliko ima jak miris.
- Pravilno rasporediti namirnice kako bi se omogućila cirkulacija vazduha oko njih.

Saveti za hlađenje

- Meso (sve vrste) umotati u polietilensku foliju za hranu i staviti na staklenu policu iznad fijke za povrće. Uvek poštovati rokove čuvanja namirnica i iskoristiti ih do datuma koje preporučuju proizvođači.
- Kuvana hrana, hladna jela, itd.: Potrebno je pokriti ih i mogu se postaviti na bilo koju policu.
- Maslac i sir:

Obmotati nepropusnom aluminijumskom ili plastičnom folijom.

- Flaše za mleko:
Moraju imati poklopac i moraju se držati u polici u vratima.

Saveti za zamrzavanje

- Prilikom prvog uključivanja nakon dužeg perioda nekorišćenja, ostaviti uređaj da radi najmanje 2 sata na višoj temperaturi pre stavljanja hrane u komoru.
- Namirnice podeliti u male porcije kako bi se omogućilo njihovo brzo i potpuno zamrzavanje i kasnije omogućilo otapanje samo one količine koja je potrebna.
- Umotati namirnice u aluminijumsku foliju ili polietilensku foliju za hranu koje omogućuju dobru zaptivenost.
- Sprečiti da sveža, nezamrznuta hrana dodirne zamrznutu hranu, kako bi se izbegao zagrevanje zamrznute hrane.
- Ukoliko se konzumiraju odmah nakon vađenja iz komore za zamrzavanje, zaleđeni proizvodi će verovatno uzrokovati promrzline na koži.
- Preporučuje se da se na svakom zamrznutom pakovanju napiše naziv i datum zamrzavanja kako bi se pratilo vreme držanja.

Saveti za čuvanje zamrznutih namirnica

- Uveriti se da je zamrznuta hrana pravilno čuvana u prodavnici
- Kada se odlede, namirnice brzo propadaju i ne mogu se ponovo zalediti. Ne prekoračivati period čuvanja koji je naznačen od strane proizvođača.

Isključivanje vašeg uređaja

Ukoliko je potrebno isključiti uređaj na duži vremenski period, potrebno je preduzeti sledeće korake kako bi se sprečila pojava buđi u uređaju.

1. Izvaditi svu hranu.
2. Izvaditi utikač iz utičnice.
3. Temeljno očistiti i osušiti unutrašnjost.
4. Uveriti se da su oba vrata blokirana u blago otvorenom položaju kako bi se omogućila cirkulacija vazduha.

Čišćenje i nega

Iz higijenski razloga uređaj (uključujući unutrašnje i spoljašnje elemente) bi trebalo redovno čistiti, najmanje svaka dva meseca. **Oprez!** Uređaj ne bi trebalo da bude uključen u struju tokom čišćenja. Opasnost od strujnog udara! Pre održavanja, isključiti uređaj i izvaditi glavni utikač iz utičnice.

Čišćenje spoljašnjosti

Kako bi se zadržao dobar izgled uređaja, potrebno je redovno čišćenje.

- Prebrisati digitalni panel i panel displeja čistom, mekom krpom.

- Navlažiti krpu za čišćenje vodom umesto prskanja direktno na površinu uređaja. To omogućuje ravnomerno raspoređivanje vlage po površini.

- Očistiti vrata, ručice i površine kutije blagim deterdžentom pa zatim obrisati mekom krpom.

Oprez!

- Ne koristiti oštre predmete jer mogu izgrebati površinu.

- Ne koristiti razređivače, deterdžent za automobile, Clorox, eterična ulja, abrazivna sredstva za čišćenje ili organske rastvarače kao što je Benzen. Oni mogu oštetiti površinu uređaja i izazvati požar.

Čišćenje unutrašnjosti

Potrebno je redovno čistiti unutrašnjost uređaja. Lakše je očistiti uređaj kad je u njemu malo hrane. Prebrisati unutrašnjost frižidera i zamrzivača blagim rastvorom sode bikarbone a zatim isprati toplom vodom pomoću iscećenog sunđera ili krpe. Pre ponovnog postavljanja polica i kutije za održavanje svežine prebrisati unutrašnjost dok ne bude potpuno suva.

Dobro osuširi sve površine i montažne delove.

Na unutrašnjim zidovima komore zamrzivača se može formirati sloj leda ukoliko se vrata zamrzivača često otvaraju ili se predugo drže otvorenim. Ukoliko je led previše debeo, izabrati trenutak kada su zalihe hrane niske i postupiti na sledeći način:

1. Izvaditi hranu i pomoćne elemente i korpe, isključiti uređaj iz struje i ostaviti otvorena vrata. Dobro provetriti prostoriju kako bi se ubrzao procesa otapanja.
2. Kada je otapanje gotovo, očistite zamrzivač kao što je opisano u nastavku.

Oprez! Ne koristiti oštre predmete za uklanjanje leda iz komore zamrzivača. Tek kada se unutrašnjost potpuno osuši uređaj bi trebalo uključiti u struju.

Čišćenje dihtunga vrata

Voditi računa da dihtunzi vrata budu uvek čisti. Lepljiva hrana i pića mogu uzrokovati slepljivanje dihtunga za konstrukciju i njihovo cepanje prilikom otvaranja vrata. Oprati dihtung blagim deterdžentom i toplom vodom. Isprati i dobro osušiti nakon čišćenja.

Oprez! Uređaj se može uključiti tek nakon što se dihtunzi vrata potpuno osuše.

Otapanje frižidera

Zbog čega otapamo frižider

- Voda iz hrane ili vlaga iz vazduha koji ulazi u frižider prilikom otvaranja vrata mogu formirati sloj leda unutar frižidera. To će oslabiti moć hlađenja kada je led debeo. Kada sloj leda postane deblji od 10mm, potrebno je obaviti otapanje.

Otapanje u odeljku za čuvanje sveže hrane

- Ovaj proces se kontroliše automatski uključivanjem ili isključivanjem regulatora temperature tako da nema potrebe za operacijom otapanja. Voda koja se stvara otapanjem će se automatski sakupiti u posudi za kapanje preko drenažne cevi na zadnjoj strani frižidera.

Otapanje u odeljku za čuvanje zamrznute hrane

- Otapanje u komori za zamrzavanje se kontroliše manuelno. Pre otapanja izvaditi namirnice.
- Izvaditi policu za led i hranu iz fижoka ili ih privremeno smestiti u odeljak za svežu hranu.
- Podesiti dugme regulatora temperature u položaj "0" (kompresor će se isključiti) i ostaviti vrata frižidera otvorenim sve dok se led i inje u potpunosti ne otope i dok se voda ne akumulira na dnu komore zamrzivača.

Prikupiti vodu mekom krpom.

- Kako bi se ubrzao proces otapanja, možete postaviti posudu sa toplom vodom (oko 50°C) u komoru za zamrzavanje i sastrugati led pomoću strugača za otapanje. Nakon toga, obavezno vratiti dugme regulatora temperature u početni položaj.
- Ne savetuje se direktno zagrevanje komore za zamrzavanje toplotom vodom ili fenom za sušenje kose prilikom otapanja kako bi se izbeglo deformisanje unutrašnjeg kućišta.
- Ne savetuje se struganje leda ili razdvajanje namirnica od ambalaže koja je slepljena sa namirnicama pomoću oštrih alata ili drvenih štapova, kako se ne bi oštetilo unutrašnje kućište ili površina evaporatora.
Upozorenje! Za isključivanje uređaja pre otapanja, okrenuti regulator temperature u položaj "0".

Važno! Frižider bi trebalo otpadati najmanje jednom mesečno. Ukoliko se vrata uređaja često otvaraju tokom njegove upotrebe ili se uređaj koristi u veoma vlažnim uslovima, savetujemo korisniku da postupak otapanja frižidera obavlja svake dve nedelje.

Stavljanje uređaja van upotrebe duže vreme

- Izvaditi sva rashlađena pakovanja.
- Isključiti uređaj okretanjem regulatora temperature u položaj "0".
- Izvaditi utikač iz utičnice, isključiti prekidač ili prekinuti dovod struje.
- Temeljno ga očistiti (videti odeljak: Čišćenje i nega)
- Ostaviti vrata otvorenim kako bi se sprečilo stvaranje neprijatnih mirisa.
Napomena: Ukoliko uređaj sadrži odeljak za zamrzavanje

Otklanjanje problema

Ukoliko otkrijete problem na vašem uređaju ili mislite da vaš uređaj ne funkcioniše kako treba, možete obaviti neke jednostavne provjere pre pozivanja servisa, kao što je opisano u nastavku.

Upozorenje! Ne pokušavajte da sami popravite uređaj. Ukoliko se problem nastavi nakon što se obavili provjere pomenute u nastavku, kontaktirajte kvalifikovanog električara, ovlašćenog servisera ili prodavnicu u kojoj ste kupili proizvod.

Problem	Mogući uzrok i rešenje
Uređaj ne funkcioniše kako treba	Proveriti da li je utikač pravilno uključen u utičnicu.
	Proveriti osigurač ili strujno kolo vašeg napajanja, zameniti ukoliko je potrebno.
	Temperatura sredine je preniska. Pokušati za podešavanjem temperature komore na niži nivo kako bi se razrešio ovaj problem.
Neprijatni mirisi iz komora	Unutrašnjost se možda mora očistiti
	Neke namirnice, posude ili omotači mogu izazvati neprijatne mirise.
Šum iz uređaja	<ul style="list-style-type: none"> • Zvuci opisani u nastavku su normalni: <ul style="list-style-type: none"> Šum prilikom rada kompresora. • Komora ili drugi odeljci. • Zvuk mehurića sličan kao pri klučanju vode. • Zvuk pucanja nakon automatskog otapanja. • Zvuk klikova pre uključivanja kompresora.
	Drugi neuobičajeni šumovi su posledica doleopisanih razloga i možda će zahtevati vašu proveru i preduzimanje mera: <ul style="list-style-type: none"> • Frižider nije nivelisan. • Zadnja strana uređaja dodiruje zid. • Flaše ili posude su pale ili se kotrljaju.
Neprekidan rad motora	Normalno je da se zvuk motora često čuje, jer će u sledećim okolnostima morati više da radi: <ul style="list-style-type: none"> • Podešena temperatura je niža nego što je potrebno • Velika količina vruće hrane je nedavno stavljena u uređaj. • Temperatura van uređaja je previsoka. • Vrata su predugo otvorena ili se otvaraju prečesto. • Nakon instaliranja uređaja ili dugog perioda van upotrebe.
U komori se javlja sloj leda	Uveriti se da je hrana raspoređena u uređaju tako da je omogućena dovoljna ventilacija. Uveriti se da su vrata potpuno zatvorena. Za uklanjanje leda, molimo pogledajte poglavlje Čišćenje i nega.
Unutrašnja temperatura je previsoka	Možda ste ostavili vrata otvorenim predugo ili prečesto; ili su vrata otvorena zbog neke prepreke; ili je uređaj postavljen tako da nije obezbeđeno dovoljno slobodnog prostora sa bočnih strana, sa zadnje ili sa gornje strane.

Unutrašnja temperatura je preniska	Povećati temperaturu u skladu sa poglavljem "Kontrole na displeju".
Vrata se teško zatvaraju	Proveriti da li je gornji deo frižidera nagnut unazad za 10-15mm kako bi se omogućilo samostalno zatvaranje vrata, ili nešto unutra sprečava zatvaranje vrata.
Voda kaplje na pod	Posuda za vodu (koja se nalazi sa donje zadnje strane frižidera) možda nije pravilno nivelisana, ili drenažna cev (koja se nalazi ispod gornje strane odeljka sa kompresorom) nije pravilno postavljena za usmeravanje vode u ovu posudu, ili je drenažna cev zapušena. Možda ćete morati da izvučete frižider dalje od zida kako biste proverili posudu i cev.
Svetlo ne radi	Sijalica može biti oštećena. Za zamenu sijalica videti poglavlje Rad uređaja.

Odlaganje uređaja

Zabranjeno je odlagati ovaj uređaj zajedno sa kućnim otpadom.

Ambalažni materijal

Ambalažni materijal obeležen simbolom za reciklažu se može reciklirati. Ambalažu odlagati u odgovarajući kontejner za otpad kako bi se omogućila njena reciklaža.

Pre odlaganja uređaja

1. Izvući utikač iz utičnice.
2. Iseći strujni kabl i odložiti ga zajedno sa utikačem

Upozorenje! Frižideri sadrže rashladno sredstvo i gasove u izolaciji. Rashladno sredstvo i gasovi se moraju odlagati na stručan način jer mogu izazvati povrede očiju ili se mogu zapaliti.

Uveriti se da cevi kola sa rashladnim sredstvom nisu oštećene pre pravilnog odlaganja.

	Pravilno odlaganje ovog proizvoda
	<p>Ovaj simbol na proizvod ili na njegovoj ambalaži ukazuje na to da se ovaj proizvod ne sme tretirati kao običan otpad iz domaćinstva. Umesto toga, potrebno je odneti ga na odgovarajuće odgovarajuće mesto za prikupljanje otpada za reciklažu električne i elektronske opreme. Obezbeđivanjem pravilnog odlaganja ovog proizvoda, pomoći ćete u sprečavanju negativnih posledica po životnu sredinu i zdravlje ljudi, koje bi inače bile izazvane neodgovarajućim odlaganjem ovog proizvoda. Za detaljnije informacije o recikliranju ovog proizvoda, molimo vas da kontaktirate lokalne nadležne organe, službu za odlaganje vašeg kućnog otpada ili prodavnicu u kojoj ste kupili proizvod.</p>

Kako bi se izbegla kontaminacija hrane, molimo pratite sledeće smernice

- Otvaranje vrata na duže vreme može izazvati znatno povećanje temperature u komorama uređaja.
- Redovno čistiti površine koje dolaze u dodir sa hranom i pristupačne sisteme za pražnjenje vode.
- Očistiti rezervoare za vodu ukoliko nisu korišćeni 48 h.
- Sveže meso i ribu držati u odgovarajućim posudama u frižideru, tako da ne dođu u dodir ili kako ne bi kapali na druge namirnice.
- Odeljci za zamrznutu hranu sa dve zvezdice su podesni za skladištenje prethodno zamrznute hrane, čuvanje ili pravljenje sladoleda i pravljenje ledenih lizalica.
- Odeljci sa jedno, dve ili tri zvezdice, nisu podesni za zamrzavanje sveže hrane.
- Ukoliko je rashladni uređaj prazan duže vreme, isključiti ga, otopiti, očistiti, osušiti i ostaviti vrata otvorenim kako bi se sprečilo formiranje buđi u uređaju.

Redosled	TIP odeljka	Ciljna temp. čuvanja hrane [°C]	Odgovarajuće namirnice
1	Frižider	+2 ~ -1-8	Jaja, kuvana hrana, upakovana hrana, voće i povrće, mlečni proizvodi, torte, pića i druge namirnice koje nisu podesne za zamrzavanje.
2	(***)*-Zamrzivač	≤-18	Morska hrana (riba, škampi, školjke), namirnice od slatkovodnih životinja i proizvodi od mesa (preporučeno 3 meseca, što je duže vreme čuvanja, lošiji je ukus i hranljiva vrednost), podesno za zamrznutu svežu hranu.
3	***-Zamrzivač	≤-18	Morska hrana (riba, škampi, školjke), namirnice od slatkovodnih životinja i proizvodi od mesa (preporučeno 3 meseca, što je duže vreme čuvanja, lošiji je ukus i hranljiva vrednost), nije podesno za zamrznutu svežu hranu.
4	** -Zamrzivač	≤-12	Morska hrana (riba, škampi, školjke), namirnice od slatkovodnih životinja i proizvodi od mesa (preporučeno 2 meseca, što je duže vreme čuvanja, lošiji je ukus i hranljiva vrednost), nije podesno za zamrznutu svežu hranu.
5	*-Zamrzivač	≤-6	Morska hrana (riba, škampi, školjke), namirnice od slatkovodnih životinja i proizvodi od mesa (preporučeno 1 meseca, što je duže vreme čuvanja, lošiji je ukus i hranljiva vrednost), nije podesno za zamrznutu svežu hranu.
6	0-zvezdica	-6 — 0	Sveža svinjetina, junetina, riba, piletina, određene upakovane prehrambene namirnice, itd. (Preporučeno da se jedne istog dana, uz preporuku da ne prođe više od 3 dana). Delimično upakovane prehrambene namirnice (namirnice koje se ne smeju zamrzavati)
7	Hlađenje	-2 — 3	Sveža/zamrznuta svinjetina, junetina, piletina, proizvodi od slatkovodnih životinja, itd. (7 dana ispod 0°C a iznad 0°C se preporučuje za konzumaciju istog dana, poželjno ne duže od 2 dana). Morska hrana (ispod 0 stepeni - 15 dana, ne preporučuje se držanje na temperaturi višoj od 0°C)

8	Sveža hrana	0 ~ +4	Sveža svinjetina, junetina, riba, spremljena hrana, itd. (Preporučeno da se jedne istog dana, uz preporuku da ne prođe više od 3 dana).
9	Vino	+5 ~ +20	crveno vino, belo vino, penušavo vino, itd.

Napomena: molimo vas da različite namirnice čuvate u skladu sa odeljcima, odnosno ciljnim temperaturama čuvanja u vašem uređaju.

- Ukoliko je rashladni uređaj prazan duže vreme, isključiti ga, otopiti, očistiti, osušiti i ostaviti vrata otvorenim kako bi se sprečilo formiranje buđi u uređaju.

Čišćenje uređaja za točenje vode (važi za proizvode sa uređajem za točenje vode):

- Očistiti rezervoare za vodu ukoliko nisu korišćeni 48h; isprati sistem za vodu koji je povezan sa dovodom vode ukoliko vode nije točena 5 dana.

Hisense
life reimagined