

EN

gorenje

INSTRUCTION MANUAL
FOR REFRIGERATOR-
FREEZER



www.gorenje.com

We thank you for the confidence you have shown by purchasing our appliance which is designed to simplify your life. To make the use of the product easier, we have supplied detailed instructions for use, and installation instructions supplied on a separate sheet. The instructions should allow you to learn about your new appliance as quickly as possible.

We wish you find a lot of pleasure in its use.

The appliance is intended solely for household use.

The refrigerator is intended for storing fresh food at temperatures above 0°C. **The freezer** is intended for freezing fresh food and for long-term storage of frozen food (up to one year, depending on the type of food).

Please visit our website where you can enter your appliance model number, indicated on the rating plate or the warranty sheet, to find detailed description of your appliance, tips on use, troubleshooting, service information, instructions for use etc.



<http://www.gorenje.com>



Important safety warning

CONTENTS

4 IMPORTANT NOTES AND PRECAUTIONS	INTRODUCTION
4 SAFETY AND WARNING INFORMATION	
11 INSTALLING YOUR NEW APPLIANCE	APPLIANCE DESCRIPTION
13 APPLIANCE DESCRIPTION	
14 CHANGING THE DOOR OPENING DIRECTION	
21 OPERATING THE APPLIANCE	
22 USING YOUR APPLIANCE	
25 HELPFUL HINTS AND TIPS	DEFROSTING AND CLEANING THE APPLIANCE
27 CLEANING AND CARE	
29 TROUBLESHOOTING	MISCELLANEOUS
31 DISPOSAL OF THE APPLIANCE	

IMPORTANT NOTES AND PRECAUTIONS



SAFETY AND WARNING INFORMATION

For your safety and correct usage, before installing and first using the appliance, read this user manual carefully, including its hints and warnings. To avoid unnecessary mistakes and accidents, it is important to make sure that all people using the appliance are thoroughly familiar with its operation and safety features. Save these instructions and be sure that they remain with the appliance if it is moved or sold, so that anyone using it throughout its life, will be properly informed on its usage and safety notices. For the safety of life and property, keep the precautions of these user's instructions as the manufacturer is not responsible for damages caused by omission.

Safety for children and others who are vulnerable people

According to EN standard

This appliance can be used by children aged from 8 years and above and persons with reduced physical, sensory or mental capabilities or lack of experience and knowledge if they have been given supervision or instruction concerning use of the appliance in a safe way and understand the hazards involved. Children shall not play with the appliance. Cleaning and user maintenance shall not be made by children without supervision.

Children aged from 3 to 8 years are allowed to load and unload refrigerating appliances.

According to IEC standard

This appliance is not intended for use by persons (including children) with reduced physical, sensory or mental capabilities, or lack of experience and knowledge, unless they have been given supervision or instruction concerning use of the appliance by a person responsible for their safety.

- Keep all packaging away from children as there is risk of suffocation.
- If you are discarding the appliance, pull the plug out of the socket, cut the connection cable (as close to the appliance as you can) and remove the door to prevent children playing from suffering an electric shock or from closing themselves inside it. I
- If this appliance, featuring a magnetic door seals, is to replace an older appliance having a spring lock (latch) on the door or lid, be sure to make the spring lock unusable before you discard the old appliance. This will prevent it from becoming a death trap for a child.



General safety

- **WARNING** —This appliance is intended to be used in household and similar applications such as
 - staff kitchen areas in shops, offices and other working environments;
 - farm houses and by clients in hotels, motels and other residential type environments;
 - bed and breakfast type environments;
 - catering and similar non-retail applications.

- WARNING — Do not store explosive substances such as aerosol cans with a flammable propellant in this appliance.
- WARNING — If the supply cord is damaged, it must be replaced by the manufacturer, its service agent or similarly qualified persons in order to avoid a hazard.
- WARNING — Keep ventilation openings, in the appliance enclosure or in the built-in structure, clear of obstruction.
- WARNING — Do not use mechanical devices or other means to accelerate the defrosting process, other than those recommended by the manufacturer.
- WARNING — Do not damage the refrigerant circuit.
- WARNING — Do not use electrical appliances inside the food storage compartments of the appliance, unless they are of the type recommended by the manufacturer.
- WARNING — The refrigerant and insulation blowing gas are flammable. When disposing of the appliance, do so only at an authorized waste disposal centre. Do not expose to flame.
- WARNING —When positioning the appliance, ensure the supply cord is not trapped or damaged.
- WARNING —Do not locate multiple portable socket-outlets or portable power supplies at the rear of the appliance.

Replacing the LED

- WARNING—The LED light must not be replaced by the user! If the LED light is damaged, contact the customer helpline for assistance.

Refrigerant

The refrigerant isobutene (R600a) is contained within the refrigerant circuit of the appliance, a natural gas with a high level of environmental compatibility, which is nevertheless

flammable. During transportation and installation of the appliance, ensure that none of the components of the refrigerant circuit becomes damaged. The refrigerant (R600a) is flammable.

- **WARNING** — Refrigerators contain refrigerant and gases in the insulation. Refrigerant and gases must be disposed of professionally as they may cause eye injuries or ignition. Ensure that tubing of the refrigerant circuit is not damaged prior to proper disposal.



WARNING! Risk of fire/flammable materials.

If the refrigerant circuit should be damaged:

- Avoid opening flames and sources of ignition.
- Thoroughly ventilate the room in which the appliance is situated.

It is dangerous to alter the specifications or modify this product in any way.

Any damage to the cord may cause a short circuit, fire, and/or electric shock.



Electrical safety

- The power cord must not be lengthened.
- Make sure that the power plug is not crushed or damaged. A crushed or damaged power plug may overheat and cause a fire.
- Make sure that you can access the main plug of the appliance.
- Do not pull the main cable.
- If the power plug socket is loose, do not insert the power plug. There is a risk of electric shock or fire.

- You must not operate the appliance without the interior lighting lamp cover.
- The fridge is only applied with power supply of single phase alternating current of 220~240V/50Hz. If fluctuation of voltage in the district of user is so large that the voltage exceeds the above scope, for safety sake, be sure to apply A.C. Automatic voltage regulator of more than 350W to the fridge. The fridge must employ a special power socket instead of common one with other electric appliances. Its plug must match the socket with ground wire.

Daily use

- Do not store flammable gass or liquids in the appliance, There is a risk of an explosion.
- Do not operate any electrical appliances in the appliance (e.g.electric ice cream makers,mixers etc.).
- When unplugging always pull the plug from the mains socket,do not pull on the cable.
- Do not place hot items near the plastic components of this appliance.
- Do not place food products directly against the air outlet on the rear wall.
- Store pre-packed frozen food in accordance with the frozen food manufacture's instructions.
- The appliances manufactures storage recommendations should be strictly adhered to.Refer to relrelevant instructions for storage.
- Do not place carbonated or fizzy drinks in the freeze compartment as it creates pressure on the container,which may cause it to explode,resulting in damage to the appliance.
- Frozen food can cause frost burns if consumed straight from the freezer compartment.
- Do not place the appliance in direct sunlight.

- Keep burning candles, lamps and other items with naked flames away from the appliance so that do not set the appliance on fire.
- The appliance is intended for keeping food stuff and/ or beverages in normal household as explained in this instruction booklet The appliance is heavy. Care should be taken when moving it.
- Do not remove nor touch items from the freezer compartment if your hands are damp/wet, as this could cause skin abrasions or frost/freezer burns.
- Never use the base, drawers, doors etc. to stand on or as supports.
- Frozen food must not be refrozen once it has been thawed out.
- Do not consume ice popsicles or ice cubes straight from the freezer as this can cause freezer burn to the mouth and lips.
- To avoid items falling and causing injury or damage to the appliance, do not overload the door racks or put too much food in the crisper drawers.
- WARNING - Food needs to be packed into bags before it is put into the refrigerator. Liquids need to be stored in bottles or capped containers in order to avoid a spill, as the design structure of the product is not easy to clean.

caution!

Care and cleaning

- Before maintenance, switch off the appliance and disconnect the mains plug from the mains socket.
- Do not clean the appliance with metal objects, steam cleaner, ethereal oils, organic solvents or abrasive cleansers.
- Do not use sharp objects to remove frost from the appliance. Use a plastic scraper.

Installation Important!

- For electrical connection carefully, follow the instructions given in this manual.
- Unpack the appliance and check if there are damages on it. Do not connect the appliance if it is damaged. Report possible damages immediately to the place you bought it. In this case retain packing.
- It is advisable to wait at least four hours before connecting the appliance to allow the oil to flow back in the compressor.
- Adequate air circulation should be around the appliance, lacking this leads to overheating. To achieve sufficient ventilation, follow the instructions relevant to installation. Wherever possible the back of the product should not be too close to a wall to avoid touching or catching warm parts (compressor, condenser) to prevent the risk of a fire, follow the instructions relevant to installation.
- The appliance must not be locate close to radiators or cookers.
- Make sure that the mains plug is accessible after the installation of the appliance

Service

- Any electrical work required to do the servicing of the appliance should be carried out by qualified electrician or competent person.
- This product must be serviced by an authorized Service Center, and only genuine spare parts must be used.
 - 1) If the appliance is Frost Free.
 - 2) If the appliance contains freezer compartment.

INSTALLING YOUR NEW APPLIANCE

- Before using the appliance for the first time, you should review the following tips.

Ventilation of appliance

In order to improve efficiency of the cooling system and save energy, it is necessary to maintain good ventilation around the appliance for the dissipation of heat. For this reason, sufficient clear space should be available around the refrigerator.

Suggest: It is advisable for there to be 50-70 mm of space from the back to the wall, at least 100 mm from its top, at least 100 mm from its side to the wall and a clear space upfront to allow the doors to open 135 °.

Please see the following diagrams

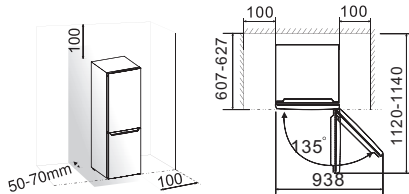

Note:

- This appliance performs well in the climate class from N to ST. It may not work properly if being left at a temperature above or below the indicated range for a long period.

Class	Temperature
SN	from +10 °C to +32 °C
N	from +16 °C to +32 °C
ST	from +16 °C to +38 °C
T	from +16 °C to +43 °C

- Stand you appliance in a dry place to avoid damage moisure.
- Keep the appliance out of direct sunlight, rain or frost. Stand the appliance away from heat sources such as stoves, fires or heaters.

Leveling of appliance

- For sufficient leveling and air circulating in the lower rear section of the appliance, the bottom feet may need to be adjusted, you can adjust them by your fingers or a suitable spanner.
- To allow the doors to self-close, tilt back the top backwards for about 10 mm.

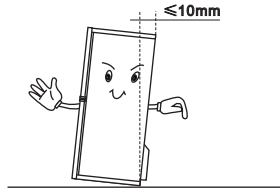

APPLIANCE DESCRIPTION

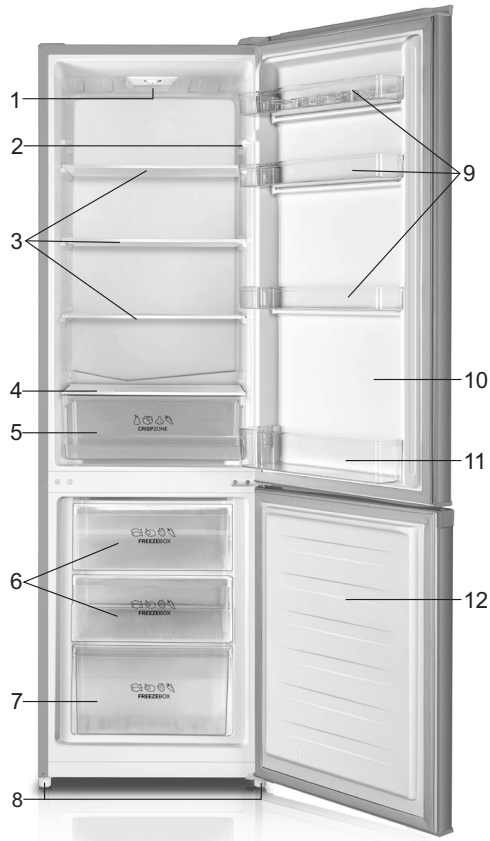

- 1. Controller box and LED light
- 2. Door switch
- 3. Shelf
- 4. Crisper box cover
- 5. Crisper drawer
- 6. Freezer upper drawer

- 7. Freezer lower drawer
- 8. Adjustable bottom feet
- 9. Upper rack
- 10. Refrigerator door
- 11. Lower rack
- 12. Freezer door







Note: Due to unceasing modification of our products, your refrigerator may be slightly different from this instruction manual, but its functions and using methods remain the same. To get more space in freezer, you can remove drawers (except the bottom freezer drawer), ice tray.

CHANGING THE DOOR OPENING DIRECTION

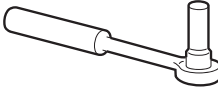
The side at which the door opens can be changed, from the right side (as supplied) to the left side, if the installation site requires.

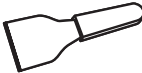
Warning! When reversing the door, the appliance must not be connected to the mains. Ensure that the plug is removed from the mains socket

Tools you will need.

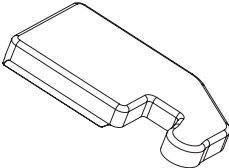
		
8mm socket wrench	Thin-blade screwdriver	Putty knife
		
Cross-shaped screwdriver	Monkey wrench	8mm wrench
Additional parts (in the plastic bag)		
		
Left hinge cover		

Note: If required you may lay the refrigerator on its back in order to gain access to the base, you should rest it on soft foam packaging or similar material to avoid damaging the backboard of the refrigerator. To reverse the door, the following steps are generally recommended.

1. Stand the refrigerator upright. Open the upper door to take out all door racks (to avoid damage) and then close the door.

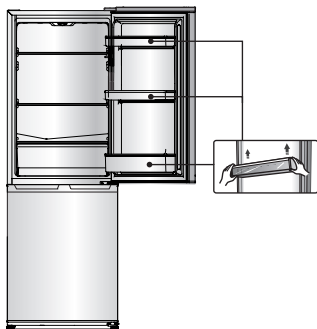

2. Use a putty knife or thin-blade screwdriver to prize the screw hole cover which is at the top left corner of the refrigerator, and the upper hinge cover which is at the top right corner of the refrigerator.

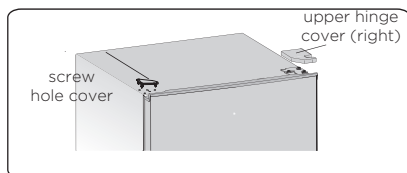

3. Unscrew the special flange self-tapping screws which are used for fixing the right upper hinge part by a 8 mm socket driver or a spanner (please support the upper door with your hand when doing it).

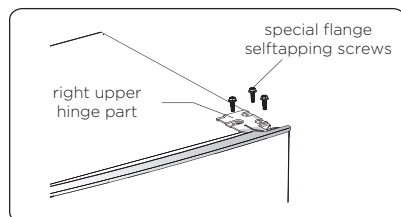

4.Remove the upper hinge axis, transfer it to reversed side and tighten securely, then put it in a safe place.

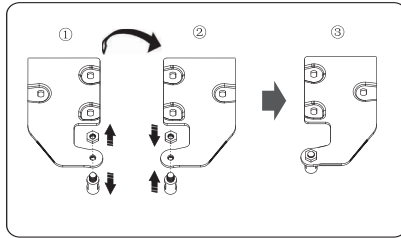

5.Remove the upper door from the middle hinge by carefully lifting the door straight up.

NOTE: When removing the door watch for washer(s) between the center hinge and the bottom of the upper door that may stick to the door. Do not lose.

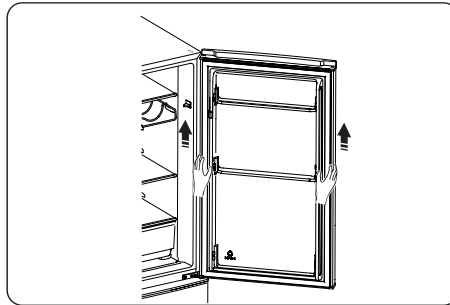

6.Place the upper door on a smooth surface with its panel upwards. Loose screw (2) and part (1), then install them to the left side and tighten securely.

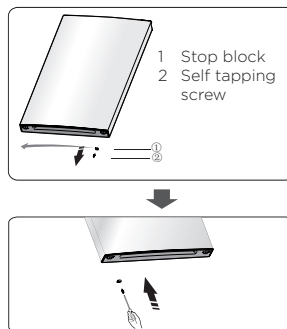

7. Unscrew the two special flange self-tapping screws which are used for fixing the middle hinge part, then remove the middle hinge part that hold the lower door in place.

NOTE: When removing the door, watch for washer(s) between the lower hinge and the bottom of the lower door that may stick to the door. Do not lose.

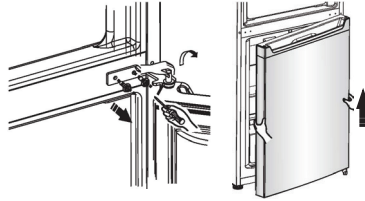

8. Place the lower door on a smooth surface with its panel upwards. Loose screw (2) and part (1), then install them to the left side and tighten securely.

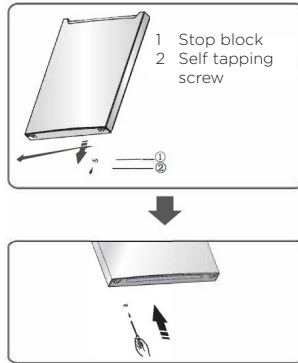

9. Change screw hole covers on middle cover plate from left to right (as shown in figure below).

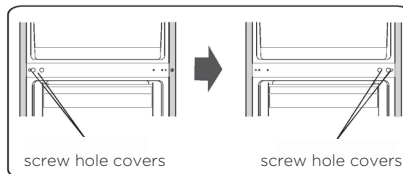

10. Lay the refrigerator on soft foam packaging or similar material. Remove both adjustable bottom feet parts, and remove the front feet board and the lower hinge part by unscrewing the special flange self-tapping screws.

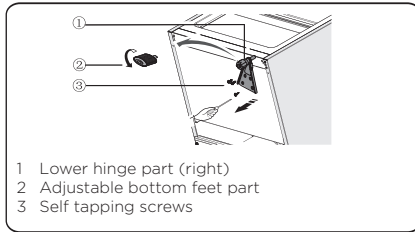

11 Replace the lower hinge part to the left side and fixing it with the special flange self-tapping screws. Replace the front feet fixed board to another side and fixing it with the special flange self-tapping screws. Install the adjustable bottom feet parts.

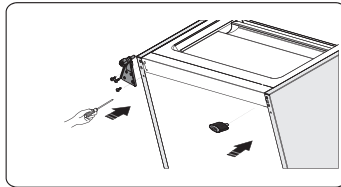

12. Transfer the lower door to the property position, adjust the lower hinge part, make the hinge axis into the lower hole of the lower door, then tight the bolts.

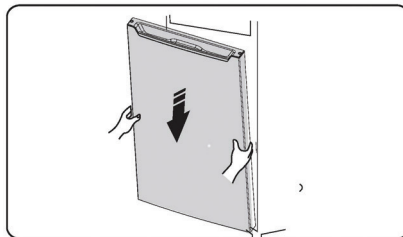

13. Upturn the middle hinge part the direction 180 degree, transfer it and adjust its position, make the middle hinge axis into the upper hole of the lower door, tight the bolts.

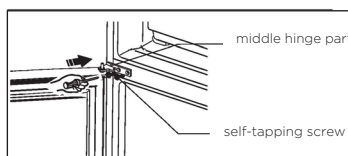

14. Transfer the upper door to the appropriate position. Secure the door's level, make the middle hinge axis into the lower hole of the upper door.

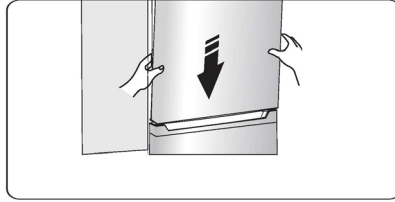

15. Transfer the upper hinge part and make the upper hinge axis into the upper hole of the upper door, and adjust the position of the upper door (please support the upper door with your hand when doing it), fixing the upper hinge part with the special flange self-tapping screws.

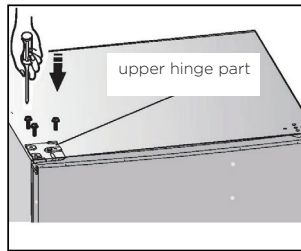

16. Install the screw hole cover on the top right corner of the refrigerator. Install the upper hinge cover (which is in the plastic bag) on the left corner. Put the other upper hinge cover into the plastic bag.

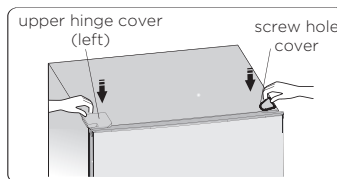

17. Open the upper door and install the door shelves, then close it.

Warning! When changing the side at which the door opens, the appliance must not be connected to the mains. Remove plug from the mains beforehand.

OPERATING THE APPLIANCE

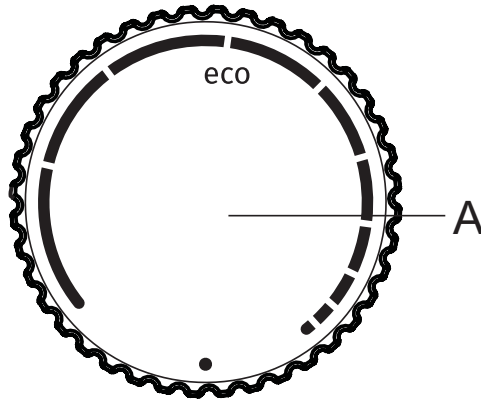

A Temperature setting and on/off knob

SWITCHING THE APPLIANCE ON/OFF

To switch on: rotate the **A** dial clockwise.

Switching off: Rotate the **A** knob back to the position in which the arrow is aligned with the symbol ● (caution: appliance will remain powered, i.e. there will still be electric current in the appliance).

ADJUSTING THE TEMPERATURE

- To set the desired temperature, rotate the **A** dial in clockwise direction, i.e. to the right.
- A change in the environment temperature will affect the temperature in the appliance. Adjust the setting with the **A** dial accordingly. Positions towards the **longer lines** mean a lower temperature in the appliance (cooler). Settings towards the **shorter lines** mean a higher temperature (warmer).
- Recommended setting of the **A** dial is on the **eco** position (see figure).
- If the temperature of the room where the appliance is installed is below 16°C, we recommend setting the **A** dial temperature to the **longest line.**

USING YOUR APPLIANCE

Accessories

Movable shelves/trays

- Various glass, plastic storage shelves or wire trays are included with your appliance - different models have different combinations and different models have different features.
- The walls of the refrigerator are equipped with a series of runner so that the shelves can be positioned as desired.

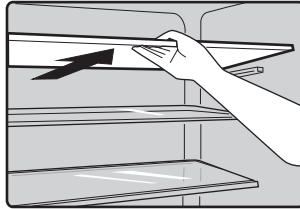

Positioning the door shelves

- To permit the storage of food packages of various sizes, the door shelves can be placed at different heights.
- To adjust, gradually pull the shelf in the direction of the arrows until it comes free, then reposition as required.

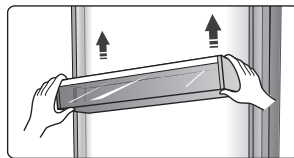

Vegetable drawer

- The drawer is suitable for storing fruit and vegetables.

Refrigerator compartment

- For storing the food that does not need to be frozen and different kinds of food.

Freezer compartment

- For freezing fresh food and storing frozen and deep-frozen food for a long time.

Thawing food

- In the refrigerator compartment
- At room temperature
- In a microwave oven
- In a convection oven
- Food once thawed should be refrozen with the exception of special cases.

Ice-cube tray

For making ice and storing ice-cubes.

To avoid contamination of food, please respect the following instructions

- Opening the door for long periods can cause a significant increase of the temperature in the compartments of the appliance.
- Clean regularly surfaces that can come in contact with food and accessible drainage systems.
- Store raw meat and fish in suitable containers in the refrigerator, so that it is not in contact with or drip onto other food.
- Two-star frozen-food compartments are suitable for storing pre-frozen food, storing or making ice cream and making ice cubes.
- One-, two- and three-star compartments are not suitable for the freezing of fresh food.

Order	Compartments TYPE	Target storage temp.[°C]	Appropriate food
1	Fridge	+2 ≤ +8	Eggs, cooked food, packaged food, fruits and vegetables, dairy products, cakes, Drinks and other foods which are not suitable for freezing.
2	(***)* - Freezer	≤ -18	Seafood (fish, shrimp, shellfish), freshwater aquatic products and meat products (recommended time is 3 months - nutrition values and taste decrease with time), suitable for frozen fresh food.
3	*** - Freezer	≤ -18	Seafood (fish, shrimp, shellfish), freshwater aquatic products and meat products (recommended time is 3 months - nutrition values and taste decrease with time). Not suitable for freezing fresh food.
4	** - Freezer	≤ -12	Seafood (fish, shrimp, shellfish), freshwater aquatic products and meat products (recommended time is 2 months - nutrition values and taste decrease with time). Not suitable for freezing fresh food.

5	* - Freezer	≤ -6	Seafood (fish, shrimp, shellfish), freshwater aquatic products and meat products (recommended time is 1 month - nutrition values and taste decrease with time). Not suitable for freezing fresh food.
6	0 star	$-6 \leq 0$	Fresh pork, beef, fish, chicken, some packaged processed foods, etc. (Recommended to eat within the same day, preferably not later than 3 days) . Partially packed/wrapped up encapsulated processed foods (non-freezable foods)
7	Chill	$-2 \leq +3$	Fresh/frozen pork, beef, chicken, freshwater aquatic products, etc. (7 days below 0 °C and above 0 °C is recommended for consumption within that day, preferably no more than 2 days). Seafood (less than 0 for 15 days, it is not recommended to store above 0 °C)
8	Fresh Food	$0 \leq +4$	Fresh pork, beef, fish, chicken, cooked food, etc. (Recommended to eat within the same day, preferably no more than 3 days)
9	Wine	$+5 \leq +20$	Red wine, white wine, sparkling wine etc.

Note: please store different foods according to the compartments or target storage temperature of your purchased products.

- If the refrigerating appliance is left empty for long periods, switch off, defrost, clean, dry, and leave the door open to prevent mould developing within the appliance.

HELPFUL HINTS AND TIPS

Energy saving tips

We recommend that you follow the tips below to save energy.

- Try to avoid keeping the door open for long periods.
- Ensure the appliance is away from any sources of heat (Direct sunlight, electric oven or cooker etc.)
- Don't set the temperature colder than necessary.
- Don't store warm food or evaporating liquid in the appliance.
- Place the appliance in a well ventilated, humidity free room. Please refer to Installing your new appliance chapter
- If the diagram shows the correct combination for the drawers, crisper and shelves, do not adjust the combination as this designed to be the most energy efficient configuration.

Hints for refrigeration

- Do not place hot food directly into the refrigerator or freezer, the internal temperature will increase resulting in the compressor having to work harder and will consume more energy.
- Do cover or wrap the food, particularly if it has a strong flavor.
- Place food properly so that air can circulate freely around it.
- Meat (All Types) Wrap in polythene food: wrap and place on the glass shelf above the vegetable drawer. Always follow food storage times and use by dates suggested by manufacturers.
- Cooked food, cold dishes, etc.: They should be covered and may be placed on any shelf.
- Fruit and vegetables: They should be stored in the special drawer provided.
- Butter and cheese: Should be wrapped in airtight foil or plastic film wrap.
- Milk bottles: Should have a lid and be stored in the door racks.

Hints for freezing

- When first starting-up or after a period out of use. Before putting the food in the compartment, let the appliance run at least 2 hours on the higher settings.
- Prepare food in small portions to enable it to rapidly and completely frozen and to make it possible to subsequently thaw only the quantity required.
- 'Wrap up the food in aluminum foil or polyethylene (plastic) and make sure that the packages are airtight.
- Do not allow fresh, unfrozen food to touch food that is already frozen, thus avoiding a rise in the temperature of latter.
- Iced products, if consumed immediately after removal from the freezer compartment can possibly cause skin to become freezer burnt.
- It is recommended to label and date each frozen package in order to keep track of the storage time.

Hints for the storage of frozen food

- Make sure that commercially frozen food was stored by the retailer.
- Once defrosted, foods deteriorate rapidly and can not be re-frozen.
- Do not exceed the storage period indicated by the food manufacturer.
Note: If the appliance contains related accessories and functions.

CLEANING AND CARE

For hygienic reasons, the appliance interior, including interior accessories, should be cleaned regularly. The appliance should be cleaned and maintained at least every two months.

Warning!

The appliance should not be connected to the main power supply during cleaning. Before cleaning, switch the appliance off and remove the plug from the main power supply, switch off, or shut off the circuit breaker of fuse.

Notice!

- Remove the food from the appliance before cleaning. Store them in a cool place and keep well covered.
- Never clean the appliance with a steam cleaner. Moisture could accumulate in electrical components.
- Hot vapors can lead to the damage of plastic parts.
- Ethereal oils and organic solvents can attack plastic parts, e.g. lemon juice or the juice from an orange peel, butyric acid, or cleansers that contain acetic acid.
- Do not use any abrasive cleansers.
- Clean the appliance and the interior accessories with a cloth and lukewarm water. Commercially available dish washing detergents may also be used.
- After cleaning, wipe with fresh water and a clean dish cloth.
- Accumulation of dust at the condenser increases energy consumption; clean the condenser at the back of the appliance once a year with a soft brush or a vacuum cleaner.(Only for the outside-condenser product)
- Check the water drain hole on the rear wall of the refrigerator compartment.
- Clear a blocked drain hole with the aid of something like soft green peg, an be careful not to create any damage to the cabinet by sharp objects. After everything is dry, the appliance back into service.

Defrosting

Defrosting in the fresh food storage compartment

- Water from the defrosting option will automatically be drained into a drip tray through a drain pipe at the back of the appliance.

Defrosting in the frozen food storage compartment

- Defrosting in the freezer chamber is operated manually. Before defrosting, take the foot out.
- Take the ice tray and drawers out or put them into the fresh food compartment temporarily.
- Set the knob of the temperature regulator to the "0" (where the compressor will stop working) and leave the door of the refrigerator open until ice and frost dissolve thoroughly and accumulate at the bottom of the freezer chamber. Wipe out the water with soft cloth.

- In order to speed up the process of defrosting, you may put a bowl of warm water (about 50°C) into the freezer chamber and scrape away the ice and frost with a defrosting spatula. After doing so, be sure to set the knob of the temperature regulator to the original position.
- It is not advisable to heat the freezer chamber directly with hot water or hair dryer while defrosting to avoid deformation of the inner case.
- It is also not advisable to scrape off ice and frost or separate foods from the containers which have been congealed together with the food with sharp tools or wooden bars, so as not to damage the inner casing or the surface of the evaporator.

Warning! To switch off the appliance before defrosting, turn the temperature regulator to the “0” position.

Notice! The appliance should be defrosted at least once a month. During its usage, if the door has been used in extreme humidity, we advise the user to defrost every two weeks.

Taking the appliance out of service

- Empty the appliance.
- Pull out the power plug.
- Clean thoroughly (see section: Cleaning and Care).
- Leave the door open to prevent odors.

TROUBLESHOOTING

If you experience a problem with your appliance or are concerned that the appliance is not functioning correctly, you can carry out some easy checks before calling for service, please see below. You can carry out some easy checks according to this section before calling for service.

Warning! Don't try to repair the appliance yourself. If the problem persists after you have made the checks mentioned below, contact a qualified electrician, authorized service engineer or the shop where you purchased the product.

Problem:	Possible cause & Solution
Appliance is not working correctly	<ul style="list-style-type: none">• Check whether the power cord is plugged into the power outlet properly.• Check the fuse or circuit of your power supply, replace if necessary.• The ambient temperature is too low. Try setting the chamber temperature to a colder level to solve this problem.• It is normal that the freezer is not operating during the automatic defrost cycle, or for a short time after the appliance is switched on to protect the compressor.
Odours from the compartments	<ul style="list-style-type: none">• The interior may need to be cleaned.• Some food, containers or wrapping cause odours.
Noise from the appliance	<p>The sounds below are quite normal:</p> <ul style="list-style-type: none">• Compressor running noises.• Air movement noise from the small fan motor in the freezer compartment or other compartments.• Gurgling sound similar to water boiling.• Popping noise during automatic defrosting.• Clicking noise before the compressor starts. <p>Other unusual noises are due to the reasons below and may need you to check and take action:</p> <ul style="list-style-type: none">• The cabinet is not level.• The back of appliance touches the wall.• Bottles or containers knocking against each other.

Problem:	Possible cause & Solution
The motor runs continuously	<p>It is normal to frequently hear the sound of the motor, it will need to run more during following circumstances:</p> <ul style="list-style-type: none"> • Temperature setting is set colder than necessary. • Large quantity of warm food has recently been stored within the appliance. • The temperature outside the appliance is too high. • Doors are kept open too long or too often. • After your installing the appliance or it has been switched off for a long time.
A layer of frost occurs in the compartment	<ul style="list-style-type: none"> • Check that the air outlets are not blocked by food and ensure food is placed within the appliance to allow sufficient ventilation. Ensure the door can be fully closed. To remove the frost, please refer to the cleaning and care chapter..
Temperature inside is too warm	<ul style="list-style-type: none"> • You may have left the doors open too long or too frequently; or the doors are kept open by some obstacle; or the appliance is located with insufficient clearance at the sides, back and top.
Temperature inside is too cold	<ul style="list-style-type: none"> • Increase the temperature by following the "Display controls" chapter.
Doors can't be closed easily	<ul style="list-style-type: none"> • Check whether the top of the refrigerator is tilted back by 10-15mm to allow the doors to self close, or if something inside is preventing the doors from closing.
Water drips on the floor	<p>The water pan (located at the rear bottom of the cabinet) may not be properly leveled, or the draining spout underneath the top of the compressor depot may not be properly positioned to direct water into this pan, or the water spout is blocked, or the water is not fully inserted into the connector. You may need to pull the refrigerator away from the wall to check the pan and spout and connector.</p> <ul style="list-style-type: none"> • Check if the refrigerator is power-off for a long time, this may cause the ice in the bucket to melt into water, and flow to the floor
LED lighting does not work:	<ul style="list-style-type: none"> • If LED lighting does not work, call a service technician. • Do not attempt a repair of the LED lighting yourself, as there is danger of contact with high voltage!

DISPOSAL OF THE APPLIANCE

It is prohibited to dispose of this appliance as household waste.

Packaging materials

Packaging materials with the recycle symbol are recyclable. Dispose of the packaging into a suitable waste collection container to recycle it.

Before disposal of the appliance

1. Pull out the mains plug from the mains socket.
2. Cut off the power cord and discard with the mains plug

Warning! Refrigerators contain refrigerant and gases in the insulation. Refrigerant and gases must be disposed of professionally as they may cause eye injuries or ignition. Ensure that tubing of the refrigerant circuit is not damaged prior to proper disposal.

	CORRECT DISPOSAL OF THIS PRODUCT
	<p>The symbol on the product or its packaging indicates that the product should not be treated as normal household waste. The product should be taken to an authorized collection centre for waste electric and electronic equipment processing. Correct disposal of the product will help prevent any negative effects on the environment and health of people which could occur in case of incorrect product removal. For detailed information on removal and processing of the product, please contact the relevant municipal body in charge of waste management, your waste disposal service, or the store where you bought the product.</p>

Gorenje, d.o.o.

Partizanska 12

SI - 3320 Velenje, Slovenija

info@gorenje.com

www.gorenje.com