

ES-A2310Z0-1



Hisense

USER MANUAL

Before using the Smart Mini Projector, please read this manual carefully and keep it for future reference.

English

Important Notice

Compatibility with 3rd party products, software and services are not guaranteed. We cannot be held liable for any damage or loss suffered whilst operating, using or connecting to incompatible devices or apps.

The recording and playback of content on this or any other device may require permission from the owner of the copyright or other such rights in that content. It is your responsibility to ensure that your use of this or any other device complies with applicable copyright legislation in your country. Please refer to that legislation for more information on the relevant laws and regulations involved or contact the owner of the rights of the content you wish to record or playback.

All rights reserved.



DC voltage: This symbol indicates that the rated voltage marked with the symbol is DC voltage.



The intended use and ambient conditions for this device

This device is intended for the rendering of video and audio signals, on a table-top, in a home or office environment. It must not be used in rooms with a high level of humidity or dust concentration. The warranty is only valid if used as intended by the manufacturer.

- Do not expose this unit to rain, moisture, dripping or splashing water, and do not place objects filled with liquids, such as vases, cups, etc. on or over the unit.
- Do not touch the device with wet hands.
- Do not expose to direct air-conditioning and keep candles or other naked flames away from the device at all times.

If the device is moved from a cold environment to a hot environment, leave it switched off for at least an hour to avoid condensation. If used outside, make sure it is protected from moisture.

If you notice anything unusual, immediately remove the power plug.

In case of fire, use preferably a CO₂ gas or powder fire extinguisher. If such extinguishers are not accessible, try to isolate the electrical supply before using a water fire extinguisher.

Operation of this equipment in a residential environment could cause radio interface.

A Smart Mini Projector may fall, causing serious personal injury or death. Many injuries, particularly to children, can be avoided by taking simple precautions such as:

- ALWAYS use cabinets or stands or mounting methods recommended by the manufacturer of the Smart Mini Projector.
- ALWAYS use furniture that can safely support the Smart Mini Projector.
- ALWAYS ensure the Smart Mini Projector is not overhanging the edge of the supporting furniture.
- ALWAYS educate children about the dangers of climbing on furniture to reach the Smart Mini Projector or its controls.
- ALWAYS route cords and cables connected to your Smart Mini Projector so they cannot be tripped over, pulled or grabbed.
- NEVER place a Smart Mini Projector in an unstable location.
- NEVER place the Smart Mini Projector on tall furniture (for example, cupboards or bookcases) without anchoring both the furniture and Smart Mini Projector to a suitable support.
- NEVER place the Smart Mini Projector on cloth or other materials that may be

located between the Smart Mini Projector and supporting furniture.

- NEVER place items that might tempt children to climb, such as toys and remote controls, on the top of the Smart Mini Projector or furniture on which the Smart Mini Projector is placed.

If your existing Smart Mini Projector is being retained and relocated, the same considerations as above should be applied.

■ Power Supply

Incorrect voltages can damage the device. Only connect this unit to a power supply with the correct voltage and frequency noted on the type plate, using the supplied power cable.

The power plug must be easily accessible so that the device can be disconnected at all time. The unit is live, even if in standby mode, as long as the unit is connected to a power outlet.

It is recommended that this unit is placed on a dedicated circuit.

- Do not overload the power outlets by connect too many appliances to the same outlet. Overloaded wall outlets, extension cords, etc. are dangerous and can result in electric shock and fire.

After power off, don't turn it on again in 5 seconds. Frequent switching power supply in a short period of time can cause abnormal device.

■ Power plug and power cable

- Do not touch the power plug with wet hands.
- Do not place heavy objects on the power cable. Route the cable so that it is not kinked or laid over sharp edges, walked on or exposed to chemicals. A power cable with damaged insulation can cause electric shock and fire.
- Pull the power plug, NOT on the cable when disconnecting. The cable can become damaged and cause a short circuit if pulled on.
- Do not place the power cable near a high temperature object.
- Do not move the device with the power cable plugged into a socket.
- Do not use a damaged or loose power cable, or a damaged socket outlet.
- Do not use any power cords other than the one supplied with this unit.

■ Air ventilation and high temperatures

Install your device only where there is proper ventilation, and ensure that there is at least 20 cm free space on the sides and 5 cm free space on the back unit for air circulation. Excessive heat and obstruction of ventilation could lead to fire or early failure of some electric components.

- Do not block any ventilation openings with newspapers, tablecloths, curtains, etc.
- Do not dry clothing etc. on top of the unit.
- Take care not to touch the ventilation openings since they may become hot.
- Do not insert foreign objects into the device through the vents.

■ Warning about off-gassing

New furniture, carpet, paint, building materials and electronics can release chemicals into the air through evaporation. After you set your device up and turn it on for the first time, you may notice a slight smell within a couple of hours. This is because some components of device are heating up for the first time. The materials that we use fully meet the environmental requirements and regulations. Your device is working just fine and the fumes from the off-gassing will diminish eventually.

■ Supervision

- Do not let children play unsupervised close to the device. It could tip over, be pushed off or pulled down from the stand surface and injure someone.
- Do not allow a switched-on device to run unattended.

■ Volume

Loud music and noises can lead to irreversible damage to your ears. Avoid extreme volume, especially over long periods and when using headphones. If you hear a drumming noise in your ears, turn down the volume or temporarily stop using headphones.

■ Thunder Storms

Pull out the power plug from the device during a thunderstorm. Overvoltage caused by lightning strikes can damage the device via the wall socket.

■ Long periods of absence

As long as the power plug is connected to a live socket outlet, the device will consume power even in standby mode. The power plug should be disconnected out during long periods of absence.

■ Cleaning and care

CAUTION:

Unplug the power cord prior to cleaning the device.

Clean the device, the screen, and the remote control with a soft, moist, clean and color-natural cloth only. Do not use any chemicals.

- Do not subject the surfaces to insect repellent, solvent, thinner or other volatile substances. This may degrade the surface quality.
- Do not spray water or other liquids directly on the device. Liquid inside the device could lead to product failure.
- The surface of the display panel is treated and may be easily damaged. Take care not to scratch it with fingernails or other hard objects.
- Also wipe the power plug with a dry cloth at regular intervals.

■ Service/Repair

Never remove the cover/back of the device; there are no user serviceable parts inside. Refer all service to qualified service personnel.

■ Packaging

Keep the anti-moisture materials and plastic bags out of reach of children. Plastic bags can cause suffocation and the anti-moisture material is harmful if swallowed. If swallowed by mistake, force the patient to vomit and visit the nearest hospital.

■ Modification

Do not attempt to modify this product in any way. Unauthorized modification could void the warranty of this unit, cause electric shock and fires.

■ Remote Control batteries

- Incorrect installation may cause battery leakage, corrosion and explosion.
- Replace only with the same or equivalent type.
- Do not mix old and new batteries.
- Do not mix different battery types.
- Do not use rechargeable batteries.
- Do not burn or break up batteries.
- Be sure to dispose of batteries correctly.
- Do not expose batteries to excessive heat such as sunshine, fire or the like.

■ Disposal

Refer to the recycling section of this guide.

■ Laser

Do not look directly at the lens when this device is on because the laser light may damage your eyes!

- This product comes with a laser module. Do not tear or modify this device

in any manner; otherwise, it may result in personal injury.

RG1 IEC 62471-5: 2015

CLASS 1 LASER PRODUCT IEC 60825-1: 2014

As with any bright light source, DO NOT STARE INTO THE BEAM

$\lambda = 458\sim 472\text{nm}/519\sim 531\text{nm}/635\sim 651\text{nm}$

Wavelength 458~472nm/519~531nm/635~651nm

CAUTION:

Use of controls or adjustments or performance of procedures other than those specified herein may result in hazardous radiation exposure.

- If this device requires a repair, please wear laser eye protection with an optical density OD that is 4 or higher and has a wave length of 458-651 nm.
- Do not place any water-containing vessel on this device, such as cosmetics or liquid medicine.
- If any object or water enters this device, please unplug this device and contact the service staff of Hisense.
- Do not place any exposed fire source (e.g. burning candle) on this device. Keep away from high temperature and heat.

- Do not expose the battery to direct sunlight or candle light.
- Keep air vents on both sides clear from any objects to prevent the device from overheating inside.
- To avoid a short circuit, product damage, do not use any sharp object or metal to touch the ports or other openings on the Smart Mini Projector.
- If this device has been in a warm environment, allow any built-up condensation to evaporate first BEFORE you switch the device on.
- Do not allow a child to stand on or climb up this device.
- Do not place any object above or in front of the lens because the laser light could cause the object to become flammable.
- Clean the lens periodically with a clean cloth and make sure the Smart Mini Projector is turned off before you start.

Accessories List

- Smart Mini Projector
- 1 Remote Control
- 2 AAA Batteries
- 1 Power Cord
- 1 Power Adapter
- User Manual
- European Guarantee
- 1 HDMI Extension Adapter

NOTE:

- The accessories may be different from the list above due to different models, countries/regions. Please refer to the actual accessory bag.
- Screen is not included.

Smart Mini Projector Diagram

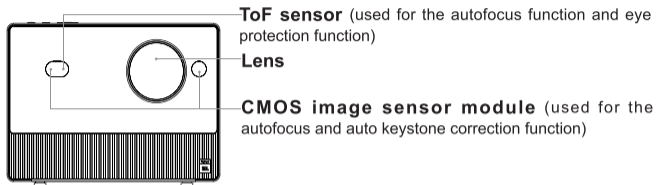

Detection range :

1. CMOS image sensor module: DFOV:78°,HFOV:70°, VFOV:43°
2. Time-of-Flight Sensor: 400mm-2000mm, FOV:27°

NOTE:

- The rated detection range of sensors may vary with different testing environments and conditions under different test product.
- Risks are inevitable in the usage of the projector even with eye protection function on. Children must be accompanied by adults when using it.
- Product image is only for reference, actual product may vary in appearance.

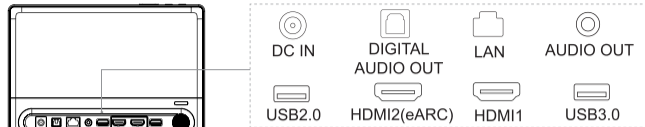
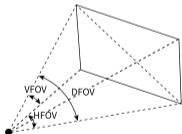

HDMI

NOTE:

If your device cannot be inserted into an HDMI port, please use the HDMI Extension Adapter in the accessories.

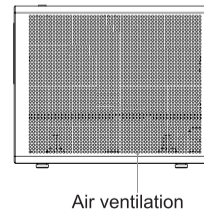
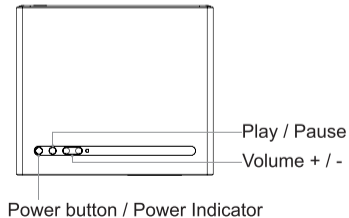
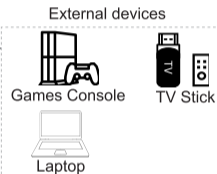

Use Your Remote

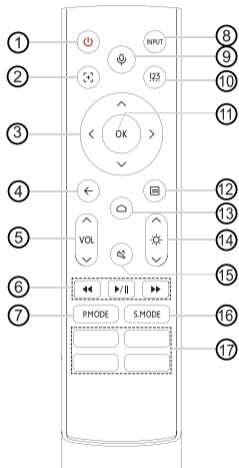

- ① Power on/Standby
- ② Press to enable automatic focus
- ③ D-pad (up/down/left/right navigation buttons)
- ④ Return to the previous place in the menu or app
- ⑤ Volume (up/down)
- ⑥ Media content control function buttons
- ⑦ Quick access to picture mode
- ⑧ Change input source
- ⑨ Activate the microphone
- ⑩ Input numbers and special function buttons
- ⑪ Confirmation button
- ⑫ Press to enter Menu
Press and hold to pair the bluetooth remote
- ⑬ Display the Home screen
- ⑭ Adjust brightness
- ⑮ Press to Mute or restore sound
- ⑯ Quick access to sound mode
- ⑰ Quick access buttons to apps

NOTE:



- The included remote will vary depending on models, countries/regions. Check information according to the actual remote in the accessory bag.
- Insert two AAA size batteries. Make sure to match the (+) and (-) ends of the batteries with the (+) and (-) ends indicated in the battery compartment.
- The remote control can work at a distance of up to 8 metres in front of the device.

1 Basic Operation

Turning the device on or off

1. Plug the power cord into a wall outlet.
2. Press the  button on the remote to turn on the device. When you turn it on for the first time, follow the instructions displayed on the screen and configure the device's basic settings.

NOTE:

- When the device is started up, you can press the  button on the remote to turn it into standby mode; When the device is in standby mode, you can press the  button on the remote to turn on the device.
- Plug the power cord off a wall outlet when you do not use the device for a long time.
- Please wait at least 10 seconds to turn on the device again when it is shut down.

 **WARNING:** Insufficient ventilation space will cause this device to overheat or become damaged.

- Do not block the air vents or place any object on this device.
- Do not place this device in any narrow, enclosed or poorly ventilated space.

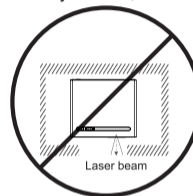

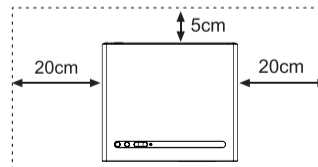

- At a minimum, leave the amount of space shown in the diagram below for this device to have proper ventilation.



2 Automatic Focus

When the automatic focus function is enabled, the device can automatically adjust the focus to make your projector picture clear.

- Enable automatic focus function by pressing the  button on the remote.
- You can enable manual focus function by pressing and holding the  button, and manually adjust the focus by pressing the D-pad on the remote.

3 Automatic Correction

Press Home button on your remote, and select  **Settings** > **Projector** > **Auto Correction**.

The device can perform automatic keystone correction on the projected screen and automatically changes the screen shape into a rectangle.

4 More Settings

Press Home button on your remote, select  **Settings** to enter the Settings Menu to set up your device.

NOTE:

- For detailed instructions, please refer to the E-Manual.
- Parts of the software function changes with the system upgrade.

5 Image Size and Projection Distance

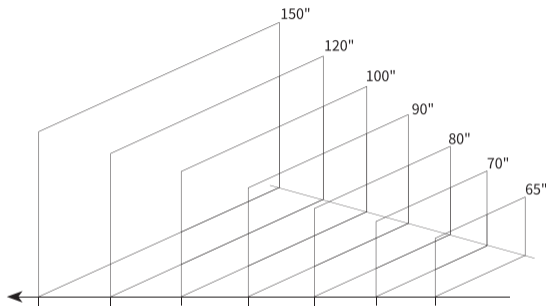

Screen Size	150"	120"	100"	90"	80"	70"	65"
Projection Distance							
mm	3985	3188	2657	2391	2125	1860	1727
inch	157	126	105	94	84	73	68

Maintenance

- Do not touch this device when it is running or just turned off because it may be hot.
- Do not wipe this device with oil because it may deteriorate the exterior or damage the paint. Contact with rubber or ethylene products for a long time may cause stains on this device.
- If the outside of the device is dirty, turn off the device and wipe with a damp soft cloth.
- Do not touch the lens with your hands.
- Do not touch or wipe the lens with ordinary cleaning cloth. Use a dust blower to remove the dust on the lens. Grease, dirt and fingerprints should be cleaned carefully by the professional by using optical cleaning cloth, lens wiping paper or professional cleaning solutions to avoid destroying the optical filming and affecting the image quality.
- To turn off this device, press the Power button on the remote control. Do not cut off the power directly when the device is working.

Quick Problem-Solving Tips

When you experience an issue with your Projector, please turn it off and on again. If this does not resolve the problem, then refer to the tips below.

1. When turn on projector, there is a delay for a few seconds before the picture appears

- This is normal because your Projector is initializing and searching for previous setting information.

2. No sound or picture

- Check if the power cord is plugged into a powered AC outlet.
- Press the Power button on the remote control to activate the unit from 'Standby' mode.
- Check the volume settings or 'Mute' mode is set to On.

3. Some irregular shadow appear on the edge of the picture after keystone correction

- Hisense projectors use digital correction, so the true resolution fills on the actual display area and leaves some surrounding area unused after a keystone correction is completed.

4. When projector is moved, automatic keystone correction function does not work properly

- Make sure that the Auto Shift Correction function is turned on in projector settings.
- Make sure that no obstacle is in front of the projection lens or camera module.

5. Remote control does not work properly

- Check if the battery power is normal.
- Take out the batteries, press any key for 1~2 seconds, and insert them back.
- In special cases, press and hold [] button to pair.

If you still have other questions, please log in to the following website and find local CUSTOMER CENTER Service Hot-line for help.

<https://global.hisense.com/support/customer-center/>

Product Specifications

Model Name	C1	
Dimension (W × H × D)	9.6 × 8.5 × 7 inches (245 × 216 × 179 mm)	
Weight	10.1 lbs (4.6 kg)	
Active Screen Size (Diagonal)	65 ~ 150 inches	
Screen resolution	3840 × 2160	
Audio power	2 × 10 W	
Power consumption	179.93 W	
Power supply	100-240V~ 60/50Hz Max 2.5A	
Power input	19V  9.47A	
Wireless LAN Module specifications	Frequency Range	2.4-2.4835GHz 5.15-5.85GHz 5.9-6.425GHz
	Output Power (Max.)	2.4-2.4835GHz 17dBm 5.15-5.25GHz 14dBm 5.25-5.35GHz(DFS Band) 14dBm 5.49-5.71GHz(DFS/TPC Band) 14dBm 5.725-5.85GHz(for Non EU) 14dBm 5.9-6.425GHz 14dBm

Bluetooth Module specifications	Frequency Range	2.4-2.4835GHz
	Output Power (Max.)	2.4-2.4835GHz, Class 1, 6dBm
Environmental conditions		Temperature: 41°F - 95°F (5°C - 35°C) Humidity: 25% - 75% RH Atmospheric pressure: 86 kPa - 106 kPa
HDMI Input		RGB / 60Hz (640×480, 800×600, 1024×768) YUV / 60Hz (480i, 480p, 720p, 1080i, 1080p) YUV / 50Hz (576i, 720p, 1080i, 1080p) 3840×2160 / 24Hz, 3840×2160 / 25Hz, 3840×2160 / 30Hz 3840×2160 / 50Hz, 3840×2160 / 60Hz
Network Standby Power Consumption		≤ 2.0 W
Power Consumption in Standby Mode		≤ 0.5 W
WIFI		IEEE 802.11 a/b/g/n/ac/ax
Bluetooth		Bluetooth 5.0

Disclaimer:

All products, product specifications, and data are subject to change without notice to improve reliability, function, design or otherwise.

Recycling / Licenses

WEEE (Waste Electronic Electric Equipment) European Directive 2012/19/EU



This symbol on the product or on its packaging indicates that this product must not be disposed of with your household waste. Instead, it is your responsibility to dispose of your waste equipment by handing it over to a designated collection point for the recycling of waste electrical and electronic equipment. The separate collection and recycling of your waste equipment at the time of disposal will help to conserve natural resources and ensure that it is recycled in a manner that protects human health and the environment. For more information about where you can drop off your waste equipment for recycling, please contact your local city office, your household waste disposal service or the shop where you purchased the product.

Batteries



In accordance with the Battery Directive, used batteries should not be disposed of in the domestic waste. Dispose your batteries in the collection containers specific for this purpose in retail stores.

ROHS (Restriction of Hazardous Substance) European Directive 2011/65/EU



This European directive limits the use of dangerous and hazardous substances which are difficult to recycle.

This allows recycling easily the EEE and contributes to the safeguard of the environment.

Substances included in this product match to the RoHS directive.



The terms HDMI and HDMI High-Definition Multimedia Interface, and the HDMI Logo are trademarks or registered trademarks of HDMI Licensing Administrator, Inc. in the United States and other countries.



Dolby, Dolby Vision, Dolby Atmos, and the double-D symbol are registered trademarks of Dolby Laboratories Licensing Corporation. Manufactured under license from Dolby Laboratories. Confidential unpublished works. Copyright © 2012–2022 Dolby Laboratories. All rights reserved.



BE	BG	CZ	DK	DE	EE	IE	EL
ES	FR	HR	IT	CY	LV	LT	LU
HU	MT	NL	AT	PL	PT	RO	SI
SK	FI	SE	NO	IS	LI	CH	TR

In all EU member states, operation of 5150-5350MHz is restricted to indoor use only.

SIMPLIFIED EU DECLARATION OF CONFORMITY

Hereby, Hisense Visual Technology Co., Ltd. declares that the radio equipment type [C1 / ERF3AD90H] is in compliance with Directive 2014/53/EU. The full text of the EU declaration of conformity is available at the following internet address: <https://global.hisense.com/support/certificate-download/>.

For Great Britain:

SIMPLIFIED UK DECLARATION OF CONFORMITY

Hereby, Hisense Visual Technology Co., Ltd. declares that the radio equipment type [C1 / ERF3AD90H] is in compliance with Radio Equipment Regulations 2017. The full text of the UK declaration of conformity is available at the following internet address: <https://global.hisense.com/support/certificate-download/>.