

EN

gorenje

DETAILED INSTRUCTIONS FOR USE OF UPRIGHT REFRIGERATOR AND FREEZER



We thank you for the confidence you have shown by purchasing our appliance which is designed to simplify your life. To make the use of the product easier, we have supplied detailed instructions for use, and installation instructions supplied on a separate sheet. The instructions should allow you to learn about your new appliance as quickly as possible.

We wish you find a lot of pleasure in its use.

The appliance is intended solely for household use.

The refrigerator is intended for storing fresh food at temperatures above 0°C. **The freezer** is intended for freezing fresh food and for long-term storage of frozen food (up to one year, depending on the type of food).

Please visit our website where you can enter your appliance model number, indicated on the rating plate or the warranty sheet, to find detailed description of your appliance, tips on use, troubleshooting, service information, instructions for use etc.



<http://www.gorenje.com>



Important safety warning

CONTENTS

4 IMPORTANT NOTES AND PRECAUTIONS 4 SAFETY AND WARNING INFORMATION	INTRODUCTION
11 INSTALLING YOUR NEW APPLIANCE 18 APPLIANCE DESCRIPTION 19 OPERATING THE APPLIANCE 22 USING YOUR APPLIANCE	APPLIANCE DESCRIPTION
26 HELPFUL HINTS AND TIPS 27 CLEANING AND CARE	DEFROSTING AND CLEANING THE APPLIANCE
30 TROUBLESHOOTING 33 DISPOSAL OF THE APPLIANCE	MISCELLANEOUS

IMPORTANT NOTES AND PRECAUTIONS



SAFETY AND WARNING INFORMATION

For your safety and correct usage, before installing and first using the appliance, read this user manual carefully, including its hints and warnings. To avoid unnecessary mistakes and accidents, it is important to make sure that all people using the appliance are thoroughly familiar with its operation and safety features. Save these instructions and be sure that they remain with the appliance if it is moved or sold, so that anyone using it throughout its life, will be properly informed on its usage and safety notices. For the safety of life and property, keep the precautions of these user's instructions as the manufacturer is not responsible for damages caused by omission.

Safety for children and others who are vulnerable people

According to EN standard

This appliance can be used by children aged from 8 years and above and persons with reduced physical, sensory or mental capabilities or lack of experience and knowledge if they have been given supervision or instruction concerning use of the appliance in a safe way and understand the hazards involved. Children shall not play with the appliance. Cleaning and user maintenance shall not be made by children without supervision.

Children aged from 3 to 8 years are allowed to load and unload refrigerating appliances.

According to IEC standard

This appliance is not intended for use by persons (including children) with reduced physical, sensory or mental capabilities, or lack of experience and knowledge, unless they have been given supervision or instruction concerning use of the appliance by a person responsible for their safety.

- Keep all packaging away from children as there is risk of suffocation.
- If you are discarding the appliance, pull the plug out of the socket, cut the connection cable (as close to the appliance as you can) and remove the door to prevent children playing from suffering an electric shock or from closing themselves inside it. I
- If this appliance, featuring a magnetic door seals, is to replace an older appliance having a spring lock (latch) on the door or lid, be sure to make the spring lock unusable before you discard the old appliance. This will prevent it from becoming a death trap for a child.



General safety

- **WARNING** —This appliance is intended to be used in household and similar applications such as
 - staff kitchen areas in shops, offices and other working environments;
 - farm houses and by clients in hotels, motels and other residential type environments;
 - bed and breakfast type environments;
 - catering and similar non-retail applications.

- WARNING — Do not store explosive substances such as aerosol cans with a flammable propellant in this appliance.
- WARNING — If the supply cord is damaged, it must be replaced by the manufacturer, its service agent or similarly qualified persons in order to avoid a hazard.
- WARNING — Keep ventilation openings, in the appliance enclosure or in the built-in structure, clear of obstruction.
- WARNING — Do not use mechanical devices or other means to accelerate the defrosting process, other than those recommended by the manufacturer.
- WARNING — Do not damage the refrigerant circuit.
- WARNING — Do not use electrical appliances inside the food storage compartments of the appliance, unless they are of the type recommended by the manufacturer.
- WARNING — The refrigerant and insulation blowing gas are flammable. When disposing of the appliance, do so only at an authorized waste disposal centre. Do not expose to flame. WARNING —When positioning the appliance, ensure the supply cord is not trapped or damaged.
- WARNING —Do not locate multiple portable socket-outlets or portable power supplies at the rear of the appliance.

Replacing the LED

- WARNING—The LED light must not be replaced by the user! If the LED light is damaged, contact the customer helpline for assistance.

Refrigerant

The refrigerant isobutene (R600a) is contained within the refrigerant circuit of the appliance, a natural gas with a high level of environmental compatibility, which is nevertheless

flammable. During transportation and installation of the appliance, ensure that none of the components of the refrigerant circuit becomes damaged. The refrigerant (R600a) is flammable.

- **WARNING** — Refrigerators contain refrigerant and gases in the insulation. Refrigerant and gases must be disposed of professionally as they may cause eye injuries or ignition. Ensure that tubing of the refrigerant circuit is not damaged prior to proper disposal.



Caution: risk of fire

If the refrigerant circuit should be damaged:

- Avoid opening flames and sources of ignition.
- Thoroughly ventilate the room in which the appliance is situated.

It is dangerous to alter the specifications or modify this product in any way.

Any damage to the cord may cause a short circuit, fire, and/or electric shock.



Electrical safety

- The power cord must not be lengthened.
- Make sure that the power plug is not crushed or damaged. A crushed or damaged power plug may overheat and cause a fire.
- Make sure that you can access the main plug of the appliance.
- Do not pull the main cable.
- If the power plug socket is loose, do not insert the power plug. There is a risk of electric shock or fire.

- You must not operate the appliance without the interior lighting lamp cover.
- The fridge is only applied with power supply of single phase alternating current of 220~240V/50Hz. If fluctuation of voltage in the district of user is so large that the voltage exceeds the above scope, for safety sake, be sure to apply A.C. Automatic voltage regulator of more than 350W to the fridge. The fridge must employ a special power socket instead of common one with other electric appliances. Its plug must match the socket with ground wire.

Daily use

- Do not store flammable gass or liquids in the appliance, There is a risk of an explosion.
- Do not operate any electrical appliances in the appliance (e.g.electric ice cream makers,mixers etc.).
- When unplugging always pull the plug from the mains socket,do not pull on the cable.
- Do not place hot items near the plastic components of this appliance.
- Do not place food products directly against the air outlet on the rear wall.
- Store pre-packed frozen food in accordance with the frozen food manufacture's instructions.
- The appliances manufactures storage recommendations should be strictly adhered to.Refer to relrelevant instructions for storage.
- Do not place carbonated or fizzy drinks in the freeze compartment as it creates pressure on the container,which may cause it to explode,resulting in damage to the appliance.
- Frozen food can cause frost burns if consumed straight from the freezer compartment.
- Do not place the appliance in direct sunlight.

- Keep burning candles, lamps and other items with naked flames away from the appliance so that do not set the appliance on fire.
- The appliance is intended for keeping food stuff and/ or beverages in normal household as explained in this instruction booklet The appliance is heavy. Care should be taken when moving it.
- Do not remove nor touch items from the freezer compartment if your hands are damp/wet, as this could cause skin abrasions or frost/freezer burns.
- Never use the base, drawers, doors etc. to stand on or as supports.
- Frozen food must not be refrozen once it has been thawed out.
- Do not consume ice popsicles or ice cubes straight from the freezer as this can cause freezer burn to the mouth and lips.
- To avoid items falling and causing injury or damage to the appliance, do not overload the door racks or put too much food in the crisper drawers.
- WARNING - Food needs to be packed into bags before it is put into the refrigerator. Liquids need to be stored in bottles or capped containers in order to avoid a spill, as the design structure of the product is not easy to clean.

Caution!

Care and cleaning

- Before maintenance, switch off the appliance and disconnect the mains plug from the mains socket.
- Do not clean the appliance with metal objects, steam cleaner, ethereal oils, organic solvents or abrasive cleansers.
- Do not use sharp objects to remove frost from the appliance. Use a plastic scraper.

Installation Important!

- For electrical connection carefully, follow the instructions given in this manual.
- Unpack the appliance and check if there are damages on it. Do not connect the appliance if it is damaged. Report possible damages immediately to the place you bought it. In this case retain packing.
- It is advisable to wait at least four hours before connecting the appliance to allow the oil to flow back in the compressor.
- Adequate air circulation should be around the appliance, lacking this leads to overheating. To achieve sufficient ventilation, follow the instructions relevant to installation. Wherever possible the back of the product should not be too close to a wall to avoid touching or catching warm parts (compressor, condenser) to prevent the risk of a fire, follow the instructions relevant to installation.
- The appliance must not be locate close to radiators or cookers.
- Make sure that the mains plug is accessible after the installation of the appliance

Service

- Any electrical work required to do the servicing of the appliance should be carried out by qualified electrician or competent person.
- This product must be serviced by an authorized Service Center, and only genuine spare parts must be used.
 - 1) If the appliance is Frost Free.
 - 2) If the appliance contains freezer compartment.

INSTALLING YOUR NEW APPLIANCE

IMPORTANT: This refrigerator is designed for indoor, household use only.

Temperature

This refrigerator is intended for use in a location where the temperature ranges from a minimum of 16 °C to a maximum of 43 °C. The preferred room temperature range for optimum performance, which reduces electricity usage and provides superior cooling, is between 16 °C and 32 °C. It is recommended that you do not install the refrigerator near a heat source, such as an oven or radiator.

Exterior and Dimensions

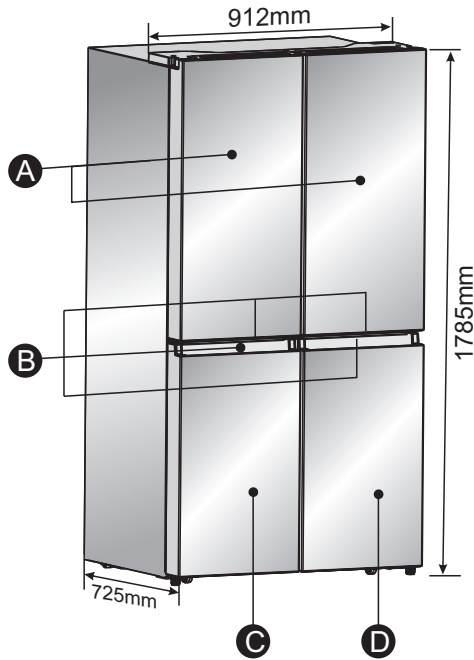

- A Refrigerator doors
- B Handles
- C Freezer door
- D Convertible freezer door

Ventilation

Adequate air circulation around the refrigerator is required for efficient operation.

To ensure proper ventilation, maintain the recommended clearances.

Recommended Clearances

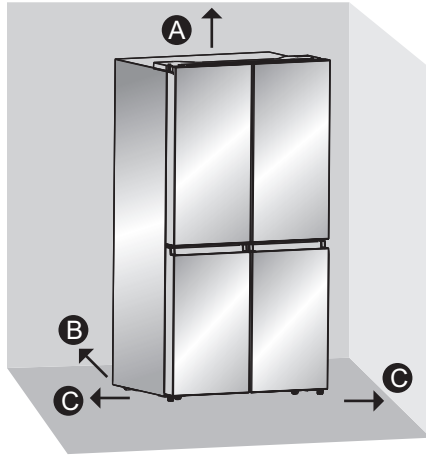

- A 100mm Above
- B 50mm Behind
- C 50mm Each Side

Electrical Requirements

Before you move your refrigerator into its final location, it is important to make sure you have the proper electrical connection.

Recommended Grounding Method

A 220-240 volt, 50 Hz, AC only 15- or 20-amp fused, grounded electrical supply is required. It is recommended that a separate circuit serving only your refrigerator be provided. Use an outlet that cannot be turned off by a switch. Do not use an extension cord.

NOTE: Before performing any type of installation or cleaning, disconnect the refrigerator from the electrical source. When you are finished, reconnect the refrigerator to the electrical source and reset the temperature controls to the desired setting.

Unpack the Refrigerator

IMPORTANT: Handle with care when moving refrigerator to avoid either damaging the refrigerant tubing or increasing the risk of a leak.

Remove the Packaging

Remove tape and glue residue from surfaces before turning on the refrigerator. Rub a small amount of liquid dish soap over the adhesive with your fingers. Wipe with warm water and dry.

NOTE: Do not use sharp instruments, rubbing alcohol, flammable fluids, or abrasive cleaners to remove tape or glue. These products can damage the surface of your refrigerator. For more information, see “Refrigerator Safety.”

- Dispose of/recycle all packaging materials.
- If the refrigerator has been placed in a horizontal or tilted position for any period of time wait 4 hours before plugging it in to allow the oil to settle into the compressor.

When Moving Your Refrigerator:

Your refrigerator is heavy. When moving the refrigerator for cleaning or service, be sure to cover the floor with cardboard or hardboard to avoid floor damage. Always pull the refrigerator straight out when moving it. Do not wiggle or “walk” the refrigerator when trying to move it, as floor damage could occur.

Clean Before Using

After you remove all of the packaging materials, clean the inside of the refrigerator before using it. See the cleaning instructions in “Refrigerator Care.”

Important information to know about glass shelves and covers:

Do not clean glass shelves or covers with warm water when they are cold. Shelves and covers may break if exposed to sudden temperature changes or impact, such as bumping. Tempered glass is designed to shatter into many small, pebble-size pieces. This is normal. Glass shelves and covers are heavy. Use both hands when removing them to avoid dropping.

Installation Positioning

This appliance performs well from N to T. The Appliance may not work properly if it is left for a longer period at a temperature above or below the indicated range.

Climate class	Ambient temperature
SN	+10 to +32
N	+16 to +32
ST	+16 to +38
T	+16 to +43

Complete the Installation

1. Plug into a grounded 3 prong outlet.
NOTE: This refrigerator begins operating as soon as it is connected to the power supply.
2. Move the refrigerator into its final location, making sure to maintain the recommended clearance.



Door Removal (only if needed)

Measure the refrigerator to make sure it will fit through the doorway. If the refrigerator cannot pass easily through the doorway, follow the instructions to remove the two refrigerator compartment doors and the front panel of the freezer drawer.

WARNING! Electrical Shock Hazard

Disconnect power before removing doors.
Reconnect ground wire before operating.
Failure to do so could result in death or electric shock.

Tools you will need (Not provided)

	
Allen Wrench (4 mm)	Wrench (8 mm)
	
Philips Screwdriver	

Remove the doors

IMPORTANT: Keep the refrigerator doors closed until you are ready to lift them from the cabinet.

1. Unplug refrigerator or disconnect power.
2. Using a Philips screwdriver, remove the three screws attaching the hinge cover, and then remove the hinge cover with the entire harnesses attached.

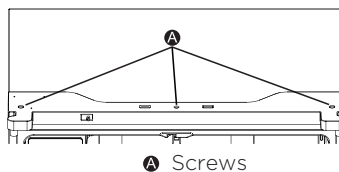

3. Remove the 3 screws (E) fixed on the hinges, with a Wrench (8 mm) and 1 ground screws (F) attached to the hinge with Philips (+) screwdriver. Remove the upper left door hinge (G).

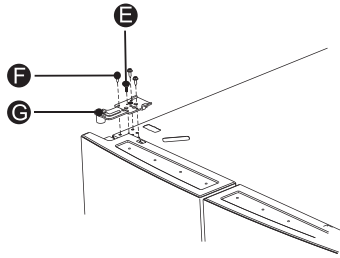

4. Use your both hands to open the door more than 90°. Lift it up and take it off.

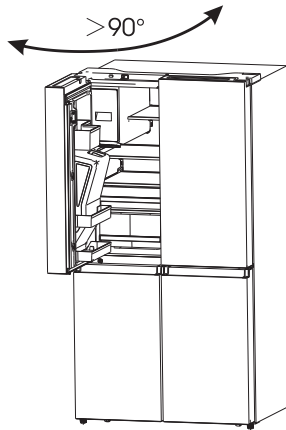

5. If necessary, remove the 2 hex head bolts hinges (I) with an Allen wrench (5 mm). Remove the lower left door hinge (H).

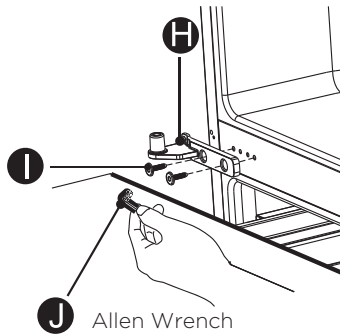

Replace the doors

1. If removed, reinstall the bottom hinge.
2. Using two or more people, set the refrigerator door onto the bottom hinge.
3. Insert the top hinge into the top of the door.
4. Using the three screws removed earlier, fasten the top hinge to the top of the cabinet.

NOTE: Left-hand door only, replace the ground screw into the top hinge, reattach the wire harness, reconnect the water line, make sure the clips are properly connected to the coupler.

5. Repeat steps 1 through 3 to replace the opposite door.
6. Using the three screws removed earlier, reinstall the top hinge cover and control panel to the top of the cabinet.

Level Refrigerator (if needed)

The refrigerator must be level to maintain optimal performance and appearance.

1. Turn the leveling feet on the bottom, front of the cabinet to raise or lower that side of the refrigerator until the refrigerator is level side to-side.
2. Turn both feet, by the same amount, to slightly raise the front of the refrigerator. This will make it easier for the doors to close.

NOTE: Having someone push against the top of the refrigerator takes some weight off the leveling feet. This makes it easier to turn the feet.

Rotate the adjustable feet clockwise to raise or raise counter-clockwise to lower your refrigerator. To make sure that the doors close automatically, tilt the top of your refrigerator backward about 10mm to 15mm. If necessary, use a spanner wrench to adjust the feet.

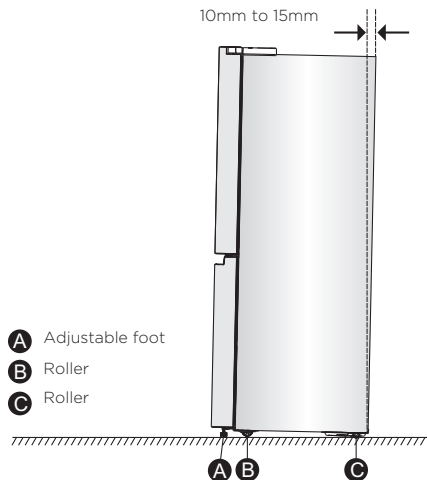

Align Doors (if needed)

The gaskets is used to align doors, you can find them in the manual bag.

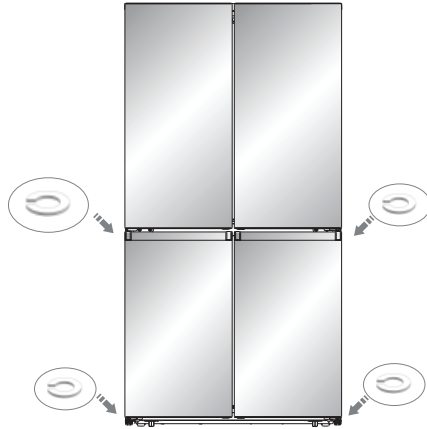

APPLIANCE DESCRIPTION



1. Refrigerator LED light and control panel
2. Mullion
3. Refrigerator door bin
4. Freezer LED light
5. Freezer tray
6. Freezer middle drawer
7. Freezer lower drawer
8. Freezer door bin
9. Glass shelf
10. Multifunctional drawer

11. Cover
12. Middle storage drawer
13. Storage drawer
14. Convertible compartment LED light
15. Convertible compartment tray
16. Convertible compartment middle drawer
17. Convertible compartment lower drawer
18. Leveling leg

Note: Your model may look different from this and other images in this manual, depending on your models features.

OPERATING THE APPLIANCE

Use your appliance according to the following control regulations, your appliance has the corresponding functions and modes as the control panels showed in the pictures below. When the appliance is powered on for the first time, the backlighting of the icons on display panel starts working. If no buttons have been pressed and the doors are closed, the backlighting will turn off.



1. POWER

Press the “POWER” 3 seconds to turn the power on, and press 3 seconds to turn the power off and will display “OF” .

2. Refrigerator (Fridge) Compartment Temperature ()

- Press ZONE repeatedly until the Fridge icon appears.
- When Fridge is on, () is illuminated and then press TEMP. repeatedly to cycle through the available temperature settings, from 8°C to 2°C.
NOTE: Each press of the button decrease the setting by one degree.

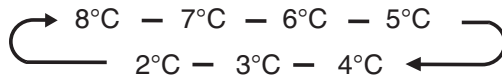

- Release the TEMP. control when the desired temperature setting appears.

3. Convert Choice Compartment Temperature ()

- Press ZONE repeatedly until the Convert Choice appears.
- When Convert Choice is on, () is illuminated and then press TEMP. repeatedly to cycle through the available temperature settings, from 5°C to -20°C.
NOTE: Each press of the button decrease the setting by one degree.

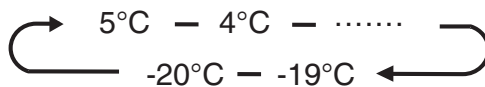

- Release the TEMP. control when the desired temperature setting appears.

4. Freezer Compartment Temperature

- Press ZONE repeatedly until the Fridge icon appears.
- When Freezer is on,  is illuminated and then press TEMP. repeatedly to cycle through the available temperature settings, from -14°C to -24°C.
NOTE: Each press of the button advances the setting by one degree.

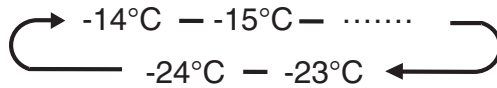



- Release the TEMP. control when the desired temperature setting appears.

5. Super Cool

The Super Cool feature helps to keep food stored in the refrigerator at the set temperature during periods of high usage, large grocery loads, or temporarily warm room temperatures.



The Super Cool feature lowers the temperature in the fridge compartment to 2°C to cool food faster.

- Press MODE repeatedly until the Super Cool icon  appears.
NOTE: When Super Cool is on,  is illuminated and 2°C appears in the temperature display.
- Press MODE to manually turn off Super Cool and return to the previously set temperature.
NOTE: Super Cool will automatically turn off after 3 hours, and the refrigerator will revert to its previous temperature setting.

6. Super Freeze

The Super Freeze feature helps to keep the food stored in the freezer at the set temperature during periods of high usage, large grocery loads, or temporarily warm room temperatures.

The Super Freeze feature lowers the temperature in the freezer compartment to -24°C to freeze food faster.

- Press MODE repeatedly until the Super Freeze icon  appears.
NOTE: When Super Freeze is on,  is illuminated and -24°C appears in the temperature display.
- Press TEMP. to manually turn off Super Freeze and return to the previously set temperature.
NOTE: Super Freeze will automatically turn off after 52 hours, and the freezer will revert to its previous temperature setting.

When selecting the Super Freeze function. ensure there are no bottled in the freezer compartment. Bottles and cans may explode.

7. Holiday

If leaving the appliance for a long period of time, you can switch the appliance over to the holiday mode.

Important! Do not store any food in the fridge compartment during this time.

- Press MODE until the Holiday icon () appears.
The appliance automatically sets the following temperatures:
 - Fridge compartment: 15 °C
 - Freezer compartment: -18°C
- Press TEMP. to turn off Holiday mode and the refrigerator temperature will revert to its previous temperature setting.

Door Open Alarm

- If a door is open for longer than 2 minutes, an alarm will sound to alert you and the control panel will display “dr”. The alarm will sound 3 times every minute for 8 minutes.
- To turn off the alarm, close all doors completely.

USING YOUR APPLIANCE

FEATURES

Important information to know about glass shelves and covers:

Do not clean glass shelves or covers with warm water when they are cold. Shelves and covers may break if exposed to sudden temperature changes or impact, such as bumping. Tempered glass is designed to shatter into many small, pebble-size pieces. This is normal. Glass shelves and covers are heavy. Use both hands when removing them to avoid dropping.

IMPORTANT: To avoid damage to the doors, make sure all shelves and drawers are pushed fully into the cabinet before closing a door.

1. Adjustable Shelves

The height of the shelves can be adjusted to fit your storage needs.

- To remove a shelf, gently lift upward and then pull the shelf forward until the end of the shelf is past the rail support.

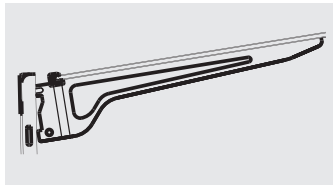
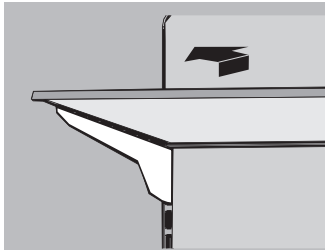

- To reinstall a shelf, gently slide the shelf back into the refrigerator compartment, and then lower the shelf onto the rail support.

2. Removable Door Bins

The bins located in the middle of the door are adjustable.

To Remove and Replace a Door Bin:

- Place hands on both sides of the bin and lift upward.
- Pull the door bin out.
- Replace the door bin by inserting it above the support and pressing down to snap into place.

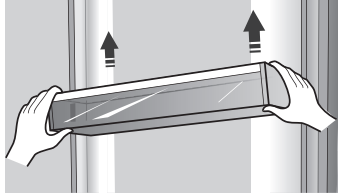

Note: The quality of your ice will be only as good as the quality of the water supplied to your ice maker. Avoid connecting the ice maker to a softened water supply. Water softener chemicals (such as salt) can damage parts of the ice maker and lead to poor quality ice. If a softened water supply cannot be avoided, make sure the water softener is operating properly and is well-maintained.

3. Freezer Drawers

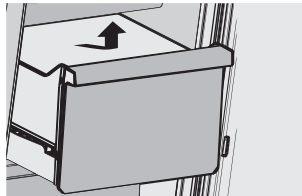

To Remove/Replace Freezer Drawer:

1. Pull out drawer to maximum extension.
2. Lift up to remove the drawer.
3. Reverse steps 1 and 2 to replace the drawer.

4. General Use Information

- When first turning on refrigerator after a period of non-use, allow the refrigerator to cool at least 2 hours before adding food.
- Do not block air circulation vents with stored items.
- Store items so that the air can circulate freely around them.
- Cover or wrap stored food well to avoid transfer of odors.
- Once defrosted, food quality will deteriorate rapidly. Defrosted food should not be refrozen.
- Neither bottled nor canned drinks should be stored in the freezer compartment. Bottles and cans may explode.

5. To avoid contamination of food, please respect the following instructions

- Opening the door for long periods can cause a significant increase of the temperature in the compartments of the appliance.
- Clean regularly surfaces that can come in contact with food and accessible drainage systems.
- Store raw meat and fish in suitable containers in the refrigerator, so that it is not in contact with or drip onto other food.
- Two-star frozen-food compartments are suitable for storing pre-frozen food, storing or making ice cream and making ice cubes.
- One-, two- and three-star compartments are not suitable for the freezing of fresh food.

Order	Compartments TYPE	Target storage temp.[°C]	Appropriate food
1	Fridge	+2 ≤ +8	Eggs, cooked food, packaged food, fruits and vegetables, dairy products, cakes, drinks and other foods which are not suitable for freezing.
2	(***)* - Freezer	≤ -18	Seafood (fish,shrimp,shellfish),freshwater aquatic products and meat products (recommended for 3 months ,the longer the storage time,the worse the taste and nutrition),suitable for frozen fresh food.
3	** - Freezer	≤ -12	Seafood (fish, shrimp, shellfish), freshwater aquatic products and meat products (recommended for 2 months,the longer the storage time,the worse the taste and nutrition), are not suitable for frozen fresh. food.
4	Chill	-2 ≤ +3	Fresh/frozen pork, beef, chicken, freshwater aquatic products, etc. (7 days below 0°C and above 0°C is recommended for consumption within that day, preferably no more than 2 days). Seafood (less than 0°C for 15 days, it is not recommended to store above 0°C)

Note: please store different foods according to the compartments or target storage temperature of your purchased products.

- If the refrigerating appliance is left empty for long periods,switch off,defrost, clean,dry, and leave the door open to prevent mould developing within the appliance.
- Compliance is checked by inspection.

WARNING! Food needs to be packed in bags before putting into the refrigerator, and liquids need to be packed in bottles or capped containers to avoid the problem that the product design structure is not easy to clean.

HELPFUL HINTS AND TIPS

Energy saving tips

We recommend that you follow the tips below to save energy.

- Try to avoid keeping the door open for long periods.
- Ensure the appliance is away from any sources of heat (Direct sunlight, electric oven or cooker etc.)
- Don't set the temperature colder than necessary.
- Don't store warm food or evaporating liquid in the appliance.
- Place the appliance in a well ventilated, humidity free room. Please refer to Installing your new appliance chapter
- If the diagram shows the correct combination for the drawers, crisper and shelves, do not adjust the combination as this designed to be the most energy efficient configuration.

Hints for refrigeration

- Do not place hot food directly into the refrigerator or freezer, the internal temperature will increase resulting in the compressor having to work harder and will consume more energy.
- Do cover or wrap the food, particularly if it has a strong flavor.
- Place food properly so that air can circulate freely around it.
- Meat (All Types) Wrap in polythene food: wrap and place on the glass shelf above the vegetable drawer. Always follow food storage times and use by dates suggested by manufacturers.
- Cooked food, cold dishes, etc.: They should be covered and may be placed on any shelf.
- Fruit and vegetables: They should be stored in the special drawer provided.
- Butter and cheese: Should be wrapped in airtight foil or plastic film wrap.
- Milk bottles: Should have a lid and be stored in the door racks.
- It is recommended to label and date each frozen package in order to keep track of the storage times.

Hints for the storage of frozen food

- Ensure that frozen food has been stored correctly by the food retailer.
- Once defrosted, food will deteriorate rapidly and should not be re-frozen. Do not exceed the storage period indicated by the food manufacturer.

Switching off your appliance

If the appliance needs to be switched off for an extended period, the following steps should be taken to prevent mould on the appliance.

1. Remove all food.
2. Remove the power plug from the mains socket.
3. Clean and dry the interior thoroughly.
4. Ensure that all the doors are wedged open slightly to allow air to circulate.

CLEANING AND CARE

Cleaning

Both the refrigerator and freezer sections defrost automatically. However, clean both sections about once a month to avoid buildup of odors. Wipe up spills immediately. To avoid odor transfer and drying out of food, wrap or cover foods tightly.

IMPORTANT:

- Do not use harsh chemicals, ammonia, chlorine bleach, concentrated detergent, solvents, abrasives or metal scouring pads to clean your refrigerator inside or out. They can damage and/or discolor the refrigerator finish.
- Do not use warm water to clean glass shelves while they are still cold. Glass may break when exposed to sudden temperature changes or impact.

Shelf parts clean

- When cleaning the shelf parts, remove the lower shelf parts that should be placed horizontally, either front or back, to prevent the shelf support from falling off.

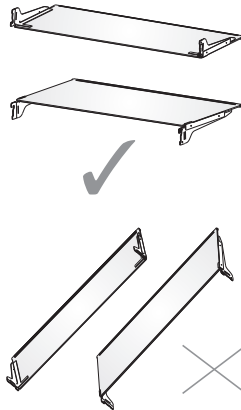

WARNING!

Unplug your appliance or disconnect power before cleaning. Failure to do so can result in death, electric shock or personal injury.

- Unplug refrigerator or disconnect power.
- Clean the interior.
Hand wash, rinse, and dry removable parts and interior surfaces thoroughly. Use a clean sponge or soft cloth and a mild detergent in warm water.

- Clean the door seals (gaskets). A dirty or sticky door seal may adhere to the cabinet and tear when you open the door.
Using a soft cloth and a solution of mild detergent and warm water, hand wash the door seals. Rinse with clear water and dry thoroughly.
- Clean the exterior surfaces.
Wash exterior surfaces with a clean, soft cloth or sponge and a mild detergent in warm water. Rinse surfaces with clean, warm water and dry immediately to avoid water spots.
- Plug in refrigerator or reconnect power.

Lights

IMPORTANT: Your refrigerator is equipped with LED lighting. These lights are designed to last for the life of your refrigerator. However, if the lights stop operating, please contact a qualified technician for replacement.

Vacation and Moving Care

Vacation

If You Choose to Leave the Refrigerator On While You're Away:

- Use up any perishables and freeze other items.

If You Choose to Turn Off the Refrigerator Before You Leave:

- Remove all food from the refrigerator and freezer.
- Unplug refrigerator or disconnect power.
- Clean refrigerator, wipe it, and dry well.
- Tape rubber or wood blocks to the tops of both doors to prop them open far enough for air to get in. This stops odor and mold from building up.

Moving

WARNING! Fire or Explosion Hazard

Do not puncture refrigerant tubing.

Follow handling instructions carefully.

Flammable refrigerant used.

Failure to do so can result in death, explosion or fire.

IMPORTANT: Handle with care when moving refrigerator to avoid either damaging the refrigerant tubing or increasing the risk of a leak.

WARNING! Use two or more people to move and install refrigerator.

Failure to do so can result in back or other injury

When you are moving your refrigerator to a new home, follow these steps to prepare it for the move.

- Remove all food from the refrigerator and pack all frozen food in dry ice.
- Unplug refrigerator.
- Clean, wipe, and dry thoroughly.

- Take out all removable parts, wrap them well, and tape them together so they don't shift and rattle during the move.
- Raise the leveling legs so they don't scrape the floor . See "Level Refrigerator."
- Tape the doors closed and tape the power cord to the back of the refrigerator. When you get to your new home, put everything back and refer to the "Installation Instructions" section for preparation instructions.

Reinstalling/Using Refrigerator Again

If the refrigerator has been placed in a horizontal or tilted position for any period of time wait 4 hours before plugging it in to allow the oil to settle into the compressor.

- Clean refrigerator. See "Cleaning."
- Place refrigerator in desired location and level. See "Installation Instructions."
- Plug into grounded 3 prong outlet.

WARNING! Electrical Shock Hazard

Plug into a grounded 3 prong outlet.

Do not remove the ground prong from the power cord plug.

Do not use an adapter.

Do not use an extension cord.

Failure to do so can result in death, fire or electrical shock.

TROUBLESHOOTING

Try the solutions suggested here first in order to avoid the cost of an unnecessary service call. Refrigerator is Not Operating

PROBLEM	POSSIBLE CAUSE (S)	SOLUTION
Refrigerator does not run	• Refrigerator is unplugged.	• Plug refrigerator into a grounded 3 prong outlet.
	• Breaker is tripped or turned off, or fuse is blown.	• Reset/Turn on breaker or replace fuse.
	• Refrigerator is in defrost mode.	• Wait for defrost cycle to end and cooling system to restart.
Refrigerator compressor runs frequently or for long periods of time Note: This refrigerator is designed to run for longer periods of time at a lower energy usage.	• Refrigerator is first plugged in.	• This is normal. Allow 24 hours for the refrigerator to cool down.
	• Warm or large amounts of food added.	• This is normal.
	• Door is left open, or refrigerator is not level.	• Check that an item is not preventing door from closing. Level the refrigerator. See "Level Refrigerator."
	• Hot weather or frequent openings.	• This is normal.
	• Temperature control set to coldest setting.	• Adjust temperature to a warmer setting.
Refrigerator has an odor	• Food is not sealed or packaged properly.	• Reseal packaging. Place an opened box of baking soda in the refrigerator, replace every 3 months.
	• Interior needs to be cleaned.	• Clean the interior. See "Cleaning."
	• Food stored too long.	• Dispose of spoiled food.
Light does not come on	• Refrigerator is unplugged.	• Plug refrigerator into a grounded 3 prong outlet.
	• LED light is burned out.	• Contact a qualified technician to replace the burned out LED.

PROBLEM	POSSIBLE CAUSE (S)	SOLUTION
Doors do not close properly	• Refrigerator is not level.	• See “Level Refrigerator.”
	• Something is obstructing door closure.	• Check for and remove obstructions.
Vibration or rattling	• Refrigerator is not resting firmly on floor.	• See “Level Refrigerator.”
Normal Sounds	• It sounds like water is flowing from the refrigerator.	• Refrigerant flowing in the lines will make this sound when the compressor starts and stops. • The refrigerator has an automatic defrosting system. The defrosted water will make this sound.
	• Humming or buzzing sounds	• The compressor and fans used for cold air circulation can make this sound. If the refrigerator is not level, the sound will be louder.
	• Cracking or clicking sounds	• The interior parts will make this sound as they contract and expand in response to temperature changes.
	• Popping noise	• May occur during automatic defrosting.
Refrigerator or freezer is too warm	• Temperature control is not set cold enough.	• Adjust the compartment to a colder setting; allow 24 hours for the temperature to adjust.
	• Doors opened frequently or left open.	• Limit door openings to maintain the internal temperature. Check that an item is not preventing door from closing.
	• Warm food added recently.	• Allow time for food and refrigerator to cool.
	• The space between the back of the refrigerator and the wall is too close.	• Allow 5 cm space between the back of the refrigerator and the wall.
	• Items against back of compartments are blocking proper airflow.	• Store items only inside the trim of the glass shelves; don't place items against sides of the compartments or directly in front of any vents.

PROBLEM	POSSIBLE CAUSE (S)	SOLUTION
Refrigerator or freezer is too cold	<ul style="list-style-type: none"> • Temperature control is set too cold. 	<ul style="list-style-type: none"> • Adjust temperature in the compartment to the next warmer setting; allow 24 hours for temperature to adjust.
Moisture on exterior/interior of refrigerator	<ul style="list-style-type: none"> • High humidity 	<ul style="list-style-type: none"> • This is normal during times of high humidity. Dry surface and adjust temperature to a slightly colder setting.
	<ul style="list-style-type: none"> • Doors opened frequently or left open. 	<ul style="list-style-type: none"> • Keep door closed. Check that an item is not preventing the door from closing. Level the refrigerator. See "Level Refrigerator."
	<ul style="list-style-type: none"> • Open container of water in refrigerator. 	<ul style="list-style-type: none"> • Cover or seal container
Frost or ice crystals on frozen food	<ul style="list-style-type: none"> • Freezer door left open or opened frequently. 	<ul style="list-style-type: none"> • Limit door openings to maintain the internal temperature. Check that an item is not preventing door from closing.
	<ul style="list-style-type: none"> • Refrigerator is not level. 	<ul style="list-style-type: none"> • Level the refrigerator. See "Level Refrigerator."
	<ul style="list-style-type: none"> • Items blocking freezer air vents and preventing proper air flow. 	<ul style="list-style-type: none"> • Move items away from rear wall.
Food freezing in refrigerator	<ul style="list-style-type: none"> • Food placed too close to the air vent. 	<ul style="list-style-type: none"> • Move items away from back and top of the refrigerator.
	<ul style="list-style-type: none"> • Temperature control set too cold. 	<ul style="list-style-type: none"> • Adjust the temperature to a less cold setting.

DISPOSAL OF THE APPLIANCE

It is prohibited to dispose of this appliance as household waste.

Packaging materials

Packaging materials with the recycle symbol are recyclable. Dispose of the packaging into a suitable waste collection container to recycle it.

Before disposal of the appliance

1. Pull out the mains plug from the mains socket.
2. Cut off the power cord and discard with the mains plug

Warning! Refrigerators contain refrigerant and gases in the insulation. Refrigerant and gases must be disposed of professionally as they may cause eye injuries or ignition. Ensure that tubing of the refrigerant circuit is not damaged prior to proper disposal.

	CORRECT DISPOSAL OF THIS PRODUCT
	The symbol on the product or its packaging indicates that the product should not be treated as normal household waste. The product should be taken to an authorized collection centre for waste electric and electronic equipment processing. Correct disposal of the product will help prevent any negative effects on the environment and health of people which could occur in case of incorrect product removal. For detailed information on removal and processing of the product, please contact the relevant municipal body in charge of waste management, your waste disposal service, or the store where you bought the product.

Gorenje, d.o.o.

Partizanska 12

SI - 3320 Velenje, Slovenija

info@gorenje.com

www.gorenje.com