

Hisense

life reimagined

USER'S OPERATION MANUAL

Before operating this unit, please read this manual thoroughly, and retain for future reference.

Dishwasher

HS642D90W

HS642D90B

HS642D90X

HS642D90WUK

HS642D90BUK

HS642D90XUK

English

Contents

Your dishwasher	4
Safety instructions	5
Installation	6
Overflow guard function	6
Winter storage/transport	6
Packaging	6
Disposal	6
Before washing for the first time	7
Water hardness	7
Basic settings	8
Top up with rinse aid	8
Top up with salt	8
Greener dishwashing	9
Save energy and water	9
Loading the dishwasher	10
Fragile dishes	10
Loading affects the results	10
The dishwasher's baskets	10
Upper basket	10
Lower basket	11
Cutlery basket	12
Using the dishwasher	13
Add detergent	13
On/Off	14
Child lock	14
Select program	14
Select option	15
Start/Pause/Stop	15
If you want to load more dishes	16
Power failure	16
Check washing times	16
Once the program has finished	16
The best drying results	16
Unloading the dishwasher	16
Program chart	17
Settings	18
Care and cleaning	20
Top up with rinse aid	20
Top up with salt	20
Clean filter	21
Cleaning the spray arms	21
Clean the outside of the dishwasher	22
CLn - Run the Clean (Self-clean) program	22
Remove blockages	22

Troubleshooting	24
Installation	28
Safety instructions	28
Transport protection for the door	28
Placing the dishwasher	29
Adjust the height and slide the dishwasher into place	29
Drainage connection	30
Connection to water supply	31
Electrical connection	32
Remove dishwasher worktop	32
Service	33
Technical data and energy labelling	34
Technical data	34
Information for consumers	34
Information for test institute	34



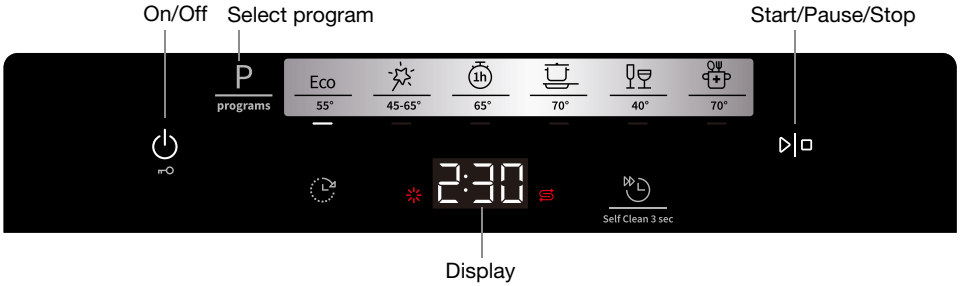

Your dishwasher

Install the dishwasher, see the chapter *Installation*. Press .



The first time the dishwasher is switched on, it is important that you choose the right settings to ensure good dishwashing results. See the chapter *Before washing for the first time*.



Program

-  Eco 55°
-  Auto 45-65°
-  1h 65°
-  Intensive 70°
-  Glass 40°
-  Hygiene 70°



Option

-  Delayed start
-  Speed wash

Special program

Self Clean 3 sec Self-clean

Information on the display
See the chapter *Care and cleaning*.

-  Top up with rinse aid
-  Top up with salt
- CLn Run the Clean (Self-clean) program

NOTE!

The control panel only reacts to use when the door is closed.

Safety instructions

- Read the operating instructions and keep them in a safe place!
- Number of standard place settings: 14
- Never use the dishwasher for any purpose other than that specified in these operating instructions.
- Do not load the dishwasher door or dishwasher baskets with anything other than dishes.
- Never leave the dishwasher door open as someone may trip on it. Push the baskets in to avoid risking the dishwasher tipping over.
- Use only dishwasher detergent!
- This appliance can be used by children aged from 8 years and above and persons with reduced physical, sensory or mental capabilities or lack of experience and knowledge if they have been given supervision or instruction concerning use of the appliance in a safe way and understand the hazards involved. Children shall not play with the appliance. Cleaning and user maintenance shall not be made by children without supervision.
- This appliance is not intended for use by persons (including children) with reduced physical, sensory or mental capabilities, or lack of experience and knowledge, unless they have been given supervision or instruction concerning use of the appliance by a person responsible for their safety. Children should be supervised to ensure that they do not play with the appliance.
- Damaged supply cord must only be replaced by the manufacturer's service centre or someone similarly professionally qualified.
- Only use the dishwasher in household-type environments for dishwashing household dishes. All other use is prohibited.
- Never place dishes with solvent residues in the dishwasher due to the risk of explosion. Nor may dishes that contain ash, wax or lubricants be washed in the dishwasher.

- Children must be watched. Do not allow children to use or play with the dishwasher. Be especially vigilant when the door is open. Some detergent may remain inside! After adding detergent, always start the dishwasher immediately.

 **WARNING!**

Knives and other pointed items must be placed with the points down in the cutlery basket or horizontally in other baskets.

 **WARNING!**

Children must be supervised – dishwasher detergent is corrosive!

Installation

See the chapter *Installation*.

Overflow guard function

The overflow guard starts pumping out the machine and turns off the water supply if the water level in the dishwasher exceeds the normal level. If the overflow guard is triggered, F54 (Overfilling water) appears on the display. Turn off the water tap and contact your nearest service centre. (To avoid water leakage outside the dishwasher, do not remove the plug from the wall socket until the water tap on the supply line has been turned off!)

Winter storage/transport

Store the dishwasher above freezing and avoid long transport distances in very cold weather. Transport the dishwasher upright or laying on its back.

Before transporting a used dishwasher, or before prolonged storage, water must first be removed from the machine.

Packaging

The outer packaging protects the product during transport. The packaging material is recyclable. Separate the different packaging materials to help reduce raw material use and waste. Your dealer can take the packaging for recycling or direct you to the nearest recycling centre. The packaging is comprised of:

- Corrugated cardboard made from up to 100% recycled material.
- Expanded polystyrene (EPS) with no added chlorine or fluorine.
- Supports made from untreated wood.
- Protective plastic made from polyethylene (PE).

Disposal

The dishwasher is manufactured and labelled for recycling. When the dishwasher has reached the end of its service life and is to be disposed of, it should immediately be made unusable. Pull out the power cable and cut it as short as possible.

Contact your local authority for information about where and how your dishwasher should be correctly recycled.

Before washing for the first time

Water hardness

In order to achieve good dishwashing results, the dishwasher needs soft water (water with low mineral content). Hard water leaves a white coating on dishes and the dishwasher.

Checking water hardness

Water hardness is specified using German degrees of water hardness (°dH), French degrees of water hardness (°fH), English degrees of water hardness (°eH) or millimoles per litre (mmol/l).

A water supply with a water hardness in excess of 2.8°dH (5°fH / 3.5°eH / 0.5 mmol/L) must be softened. This is done automatically with the aid of the built-in water softener. In order for the water softener to function properly, its settings must be adjusted to the hardness of the water supply. Once you have adjusted the water softener settings, add detergent and rinse aid in doses suitable for soft water.

Contact the local waterworks to check the water hardness in your area.

Make a note of the water hardness: _____

°dH	°fH	°eH	mmol/L	Recommended setting
0-2.8	0-5	0-3.5	0.0-0.5	00
2.9-5.6	6-10	3.6-7.0	0.6-1.0	01
5.7-11.2	11-20	7.1-14.0	1.1-2.0	02
11.3-16.8	21-30	14.1-21.0	2.1-3.0	03
16.9-22.4	31-40	21.1-28.0	3.1-4.0	04
22.5-28.0	41-50	28.1-35.0	4.1-5.0	05
28.1-36.4	51-65	35.1-45.5	5.1-6.5	06
36.4+	65+	45.5+	6.5+	07

If the water hardness exceeds 36.4°dH (65°fH / 45.5°eH / 6.5 mmol/L), we recommend connecting an external water softener.

Increased consumption during regeneration

The dishwasher's built-in water softener is regularly regenerated to maintain its function. Regeneration extends the dishwashing program and increases energy and water consumption. Just how often the dishwasher's water softener is regenerated depends on the selected setting.

Example: If the Eco 55° program is run with the default water hardness setting (04), the water softener is regenerated at regular intervals, energy consumption increases by 0.025 kWh, and water consumption increases by 2.5 litres, while the program time is extended by 1 minute. Regeneration takes place during the program's main wash.

WARNING!

Hard water leaves a white coating on dishes and inside the dishwasher. It is therefore important that you select the right setting for the water softener! See *Water hardness* in the chapter *Settings*.

Never run the dishwasher with an empty salt compartment if the water supply has a water hardness in excess of 2.8°dH (5°fH / 3.5°eH / 0.5 mmol/L).

Basic settings

The first time the dishwasher is switched on, it is important that you choose the right settings to ensure good dishwashing results. See chapter *Settings*.

Set up:

- Rinse aid
- Water hardness
- TAB

✱ Top up with rinse aid

Drying is faster and a better result is achieved if you use rinse aid. You will also achieve a better dishwashing result with clear and spotless dishes.

Top up the rinse aid compartment with rinse aid if you have selected Rinse aid 01 - 05.

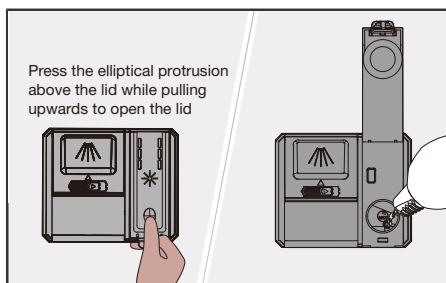

1. Open the rinse aid compartment lid.
2. Carefully top up with rinse aid to the level marked **MAX**.
3. Wipe up any splashes of rinse aid around the compartment.
4. Close the lid firmly.

⚖ Top up with salt

Add salt to the salt compartment if you have selected Water hardness 01 - 07.

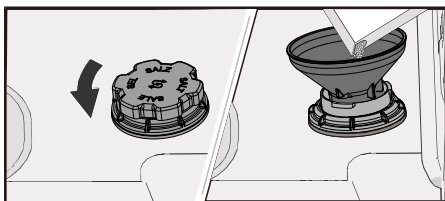

1. Remove the salt compartment lid by turning it anticlockwise.
2. Place the funnel supplied with the dishwasher in the salt compartment top-up hole. First, pour in about 1 L of water.
3. Add enough salt to fill the salt compartment (max. 750 gram). Use special dishwasher salt.
4. Wipe up any excess salt so that the lid can be screwed on firmly.

⚠ WARNING!

In order to avoid rust stains a dishwashing program must be started immediately after adding salt.

Greener dishwashing

Save energy and water

When using a dishwasher in a residential setting, less energy and water are generally used compared to washing the dishes by hand.

Do not rinse under running water



Do not rinse the dishes under running water as this will lead to increased energy and water consumption. Simply scrape off large food particles before loading the dishwasher.

Choose a green detergent

Read the environmental declaration on the packaging!

Too much detergent, rinse aid and salt can result in less effective dishwashing and also entail greater environmental impact.

Run a fully loaded dishwasher

Save energy and water by waiting until the dishwasher is full before running a program (see number of standard place settings). Use the  1h 65° program with the  Speed wash option to rinse the dishes if there are any unpleasant odours.

Run programs at a lower temperature

If the dishes are only slightly dirty, you can select a program with a low temperature.

Select dishwashing program – Eco 55°

This program is suitable for washing normally soiled dishes and is the most effective program in terms of combined energy and water consumption. This program is used to assess compliance with EU legislation on ecodesign.

The dishwashing program is designed for an effective wash using as little energy and water as possible. The program washes at a low temperature for a long time.

Activate the – Auto Dry setting

A shorter dishwashing program and better drying results are achieved if you activate the Auto Dry setting, which automatically opens the dishwasher door. Wait until the dishwasher indicates that the program has ended and the dishes have cooled before unloading the dishwasher. (If the dishwasher is built-in, the surrounding furnishings must be resistant to any condensation from the dishwasher.)

Connect to cold water

Connect the dishwasher to the cold water supply if the building is heated using oil, electricity or gas.

Connection to hot water supply

Connect the dishwasher to the hot water supply (max. 60 °C) if the building is heated using an energy-efficient means such as district heating, solar power or geothermal power. Choosing a hot water connection reduces the dishwasher's energy consumption.

NOTE!

Do not exceed the permitted water supply temperature. Certain materials used in some cookware cannot withstand high heat. See *Fragile dishes* in the chapter *Loading the dishwasher*.

Loading the dishwasher

Fragile dishes

Some cookware is not dishwasher safe. This can be for several reasons. Some materials cannot withstand high heat, others can be damaged by dishwasher detergent.

Exercise caution with, for example, handmade items, fragile decoration, crystal/glassware, silver, copper, tin, aluminium, wood and plastic. Look for the "Dishwasher safe" marking.

Loading affects the results

Load the dishes carefully to ensure the best washing and drying results with the lowest possible energy and water consumption. Give your dishwasher the best chance to reach and clean all surfaces, as well as to dry the dishes as thoroughly as possible.

- All dirty surfaces should face inwards and downwards!
- Dishes should not be placed in or on each other.
- Angle dishes with hollows, such as cups, so that the rinse water will run off. This is also important for plastic items.
- Make sure small items cannot fall through the dishwasher basket; place them in the cutlery basket.

NOTE!

Check that the spray arms can rotate freely.

The dishwasher's baskets

The dishwasher is equipped with an upper basket and a lower basket with a cutlery basket.

The appearance of the baskets may differ depending on the dishwasher setup.

Upper basket

Place glasses, cups, bowls, side plates and saucers in the upper basket. All dirty surfaces should face inwards and downwards! Wine glasses are placed on the wine glass shelf and knives are placed in the knife stand on the right.

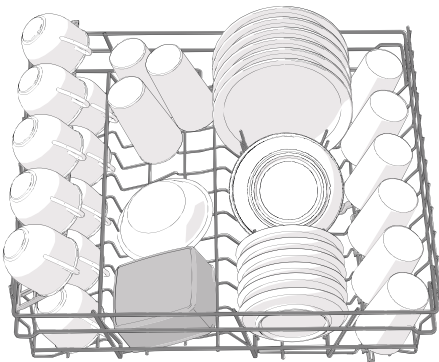

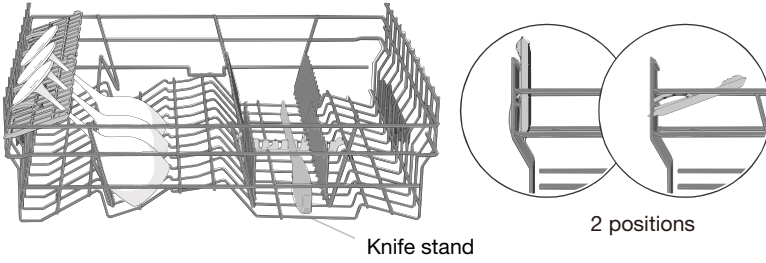

Raising and lowering the upper basket

1. Pull out the upper basket.
2. Grab the sides of the upper basket with both hands and lift it up.
3. If the upper basket is raised while in the top position, it will drop to the bottom position.
Note that both sides of the basket must always be set to the same height.

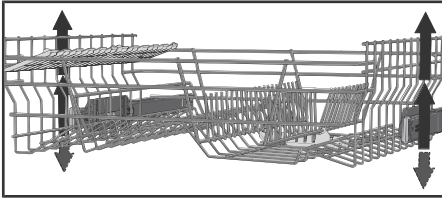

Lower basket

Place plates, side plates, serving dishes, pots and cutlery (in the cutlery basket) in the lower basket.

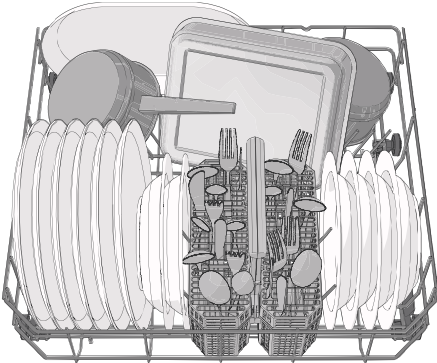

Adjustable plate supports

The adjustable plate supports can be folded down to make it easier to load pots and bowls.

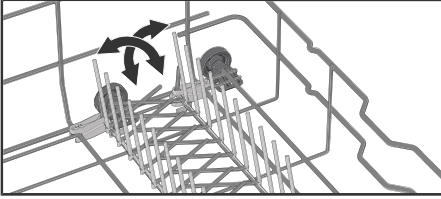

Cutlery basket

Place cutlery with the handles facing down, except for knives, and spread them out as much as possible. Ensure that spoons do not stack inside each other.

Place the cutlery basket in the lower basket.

Cutlery basket with lid

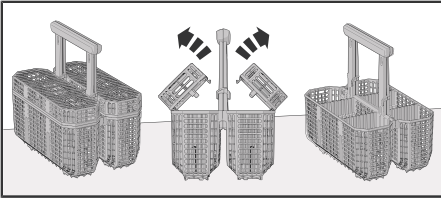

The cutlery basket lid can be removed.

Flexible cutlery basket

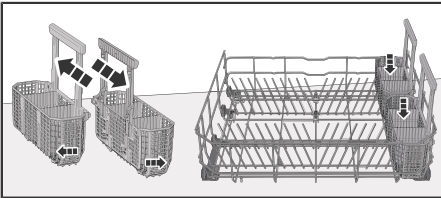

The cutlery basket is flexible and can be separated into two parts, which can then be attached to the side of the lower basket.

Using the dishwasher

Add detergent

Follow the instructions on the detergent packaging. This dishwasher is fitted with a water softener, so use detergent and rinse aid doses suitable for soft water.

Too much detergent can result in less effective dishwashing and also entails greater environmental impact.

Detergent compartment

The detergent compartment must be dry when adding detergent.

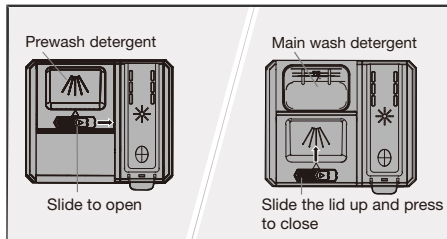

If powder or liquid dishwasher detergent is used, add a small amount of the detergent to the compartment for prewash detergent.

NOTE!

Use only dishwasher detergent! Washing up liquid **MUST** not be used as the foam that forms prevents the dishwasher from operating effectively.

All-in-one detergent

There are many types of all-in-one detergents on the market. Read through the directions for these products carefully.

Activate the TAB setting when using an all-in-one detergent that contains rinse aid.

Dishwasher tablets are not recommended for short programs (less than 75 minutes). Use powder or liquid dishwasher detergent instead.

NOTE!

Optimal washing and drying results are achieved by using normal detergent together with separately dispensed rinse aid and salt.



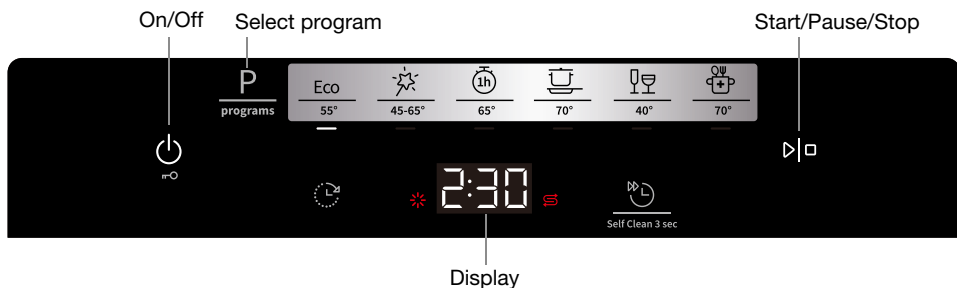

Contact the detergent manufacturer if you have questions about the detergent.





 **NOTE!**
The control panel only reacts to use when the door is closed.

On/Off

Close the door properly, otherwise the dishwasher will not start. Press . Also turn on the water tap if it is turned off.

When the program is not running, press  to turn off the dishwasher immediately. If the program runs, press and hold  for five seconds to shut down the dishwasher. Alternatively, press and hold  for three seconds to pause the dishwasher, then press  to turn off.

Child lock

To prevent children from stopping the current dishwashing program, you can activate the child lock function. Once you have started a program, press and hold  for three seconds. CL (Child Lock) will be shown on the display when pressing the control panel. (To unlock, press and hold  for three seconds.) You can also activate the Automatic child lock setting to prevent children from starting the dishwasher. See the chapter *Settings*.

P Select program

Select a program to suit the type of dishes and how dirty they are. Eco 55° is always pre-selected. Press **P** one or more times until the desired program is activated, which is indicated by an indicator light.

Eco **Eco 55°**

This program is suitable for washing normally soiled dishes and is the most effective program in terms of combined energy and water consumption. This program is used to assess compliance with EU legislation on ecodesign.

You can read more about greener dishwashing in the chapter *Greener dishwashing*.

For heavily soiled dishes with a lot of grease, a program with higher temperatures should be used.

Auto 45-65°

The dishwasher can measure how dirty the dishes are and adjust water consumption and temperature accordingly. When newly installed, the program needs to be run five times before it is fully adapted and can provide the best results.

1h 65°

A quick program for slightly dried leftovers. (This program is not intended for burnt food, such as on oven dishes.)

The Auto Dry option is important for ensuring the best drying results.

Intensive 70°

A program with a high temperature for dissolving grease on very dirty dishes, such as pans, casserole dishes and oven dishes. If these dishes do not completely fill the dishwasher, you can add plates and other dishes.

Glass 40°

A gentle dishwashing program with a low temperature for washing fragile items made of crystal/glass. Remember to use a small amount of detergent and to place items so that they do not touch each other during the wash. See also Fragile dishes in the chapter Loading the dishwasher. Porcelain that has just been used without dried leftovers can also be washed using this program.

Hygiene 70°

This program is ideal to use where demands on hygiene are extra high, e.g. for baby bottles and cutting boards. The temperature is high both in the main wash and in the final rinse.

Self Clean 3 sec Self-clean

Self-cleaning program for hygienic cleaning of the dishwasher tub, spray arms and spray pipes.

This program should be run (with no dishes in the machine) using normal dishwasher detergent or citric acid. Special dishwasher cleaners are also available on the market. For the removal of limescale deposits, see *Dishwasher tub* in the chapter *Care and cleaning*.

The dishwasher will indicate at regular intervals that Self-clean needs to be run.

Press and hold selfclean3s until CLn is shown on the display to select the program.

Select option

Press the options (🕒, 🕒) to activate them. (The available options vary between programs.)

Delayed start

When you select Delayed start, the dishwasher will start 1-24 hours after you press ▶|◻.

1. Press 🕒 once to activate Delayed start. Press several times, or hold it in, to set the desired number of hours. The time for Delayed start is shown on the display.
2. Press ▶|◻. The timer counts down and the dishwasher starts after the selected delay.

If you want to cancel the Delayed start option, press and hold ▶|◻ for five seconds.

Not available for: Self-clean

Speed wash

This option shortens the program time, but uses more energy and water.



Press 🕒 to activate the option. The program time is updated on the display.

Not available for: Auto 45-65°, Glass 40°, Hygiene 70°, Self-clean

Start/Pause/Stop

Press ▶|◻. The display starts counting down.

Stopping or changing a program



Press and hold  for three seconds to pause the program. If you want to interrupt or change the program after starting the dishwasher, press and hold  for another five seconds.

Open the door and top up with new detergent if the lid of the detergent dispenser has opened. Close the door. Then select a new program and press .

Remaining time

Once you have chosen a program and options, the total time is displayed.



If you want to load more dishes ¹⁾

Press and hold  for three seconds to pause the program. Open the door. Add the dishes and close the door. Press .

Power failure

If the dishwasher is turned off due to a power failure when a dishwashing program is running, the program continues when power is restored. If the power is cut during drying, the program is interrupted.

Check washing times

When the dishwasher is turned on, press and hold  and , and the screen will display the number of times the dishwasher has been washed. Release the button to exit.

Once the program has finished

Once the program has finished, "End" appears on the display. And the dishwasher turns off after the buzzer makes a sound.

The dishwasher switches off automatically after the program ends. Shut off the water tap after each use.

The best drying results

- Fully load the dishwasher.
- Angle dishes with hollows, such as cups, so that the rinse water will run off. This is also important for plastic items.
- Top up with rinse aid or increase the rinse aid dosage setting.
- Activate the Auto Dry setting. See the chapter *Settings*.
- Allow the dishes to cool before unloading the dishwasher.





Unloading the dishwasher

Hot porcelain is more fragile. Leave the dishes to cool in the dishwasher before unloading them.

Unload the lower basket first to avoid any water drops from the upper basket falling onto the dishes in the lower basket.

¹⁾ You should not load more dishes if the lid of the detergent dispenser has been opened.





Program chart

Program	Detergent (g)	Option	Number of pre-washes	Main wash	Number of rinses	Final rinse	Consumption values ¹⁾		
							Dishwashing time (approx. hrs:min)	Energy (approx. kWh)	Water cons. (liter)
Eco 55° ²⁾	22	Auto Dry		55 °C	2	49 °C	3:10	0.83	11.0
 Auto 45-65°	25	Auto Dry	1-2	45-65 °C	2-3	60 °C	2:10-3:10	0.9-1.4	12.0-19.0
 1h 65°	25	Auto Dry		65 °C	3	65 °C	1:00	1.1	13.0
 Intensive 70°	25		2	70 °C	2	70 °C	2:50	1.6	15.5
 Glass 40°	20			40 °C	2	50 °C	1:40	0.7	10.0
 Hygiene 70°	25			70 °C	2	70 °C	1:05	1.3	9.5

¹⁾ Consumption values vary depending on the temperature of the incoming water, room temperature, load size, selected additional functions and more. The values for the Eco 55° program are accurate, others are indicative only.

²⁾ This program is suitable for washing normally soiled dishes and is the most effective program in terms of combined energy and water consumption. This program is used to assess compliance with EU legislation on ecodesign.

Settings

1. Press .
2. To open the dishwasher's settings menu, press and hold P and  until SEt is shown on the display.
3. Press  to step through the settings menu.
4. Press P to step through the alternatives.
5. Confirm the selected setting by pressing .
6. To exit the menu, step through it or press .



Settings		Alternatives	
1	Automatic child lock	00 (Off) 01 (On)	You can activate the Automatic child lock setting to prevent children from starting the dishwasher. Once you have started a program, press and hold  for three seconds to temporarily deactivate or activate the Automatic child lock setting.
2	Sounds	00 - 03	A beep confirms that the control panel has been pressed. A beep indicates when a dishwashing program has ended. <i>Error messages are always indicated by a loud buzzer.</i>
3	Rinse aid	00 - 05	Setting for rinse aid dosage. The rinse aid dispenser can be adjusted between 00 (Off) and 05 (High dosage). Increase the rinse aid dosage: <ul style="list-style-type: none"> • If the dishes have water marks. Decrease the rinse aid dosage: <ul style="list-style-type: none"> • If the dishes have a sticky white/blue film. • If the dishes are streaked. • Build-up of foam. If you have very soft water, the rinse aid can be diluted 50:50 with water. <i>Pre-selected at factory: 03</i>
4	Water hardness	00 - 07	Adjusting the water softener. Select a setting depending on the hardness of the water supply. It is important that this setting is correct!

Settings		Alternatives	
			<p>See <i>Water hardness</i> in the chapter <i>Before washing for the first time</i>.</p> <p>For a water supply with a hardness below 2.8°dH (5°fH / 3.5°eH / 0.5 mmol/l), select 00. The water softener is deactivated and no salt needs to be added.</p> <p><i>Pre-selected at factory: 04</i></p>
5	TAB	00 (Off) 01 (On)	<p>Activate this setting when using an all-in-one detergent that contains rinse aid.</p> <p>This setting reduces the rinse aid dosage and affects how often the dishwasher's built-in softener is regenerated.</p> <p><i>Pre-selected at factory: 00</i></p>
6	Auto Dry	00 (Off) 01 (On)	<p>The dishwasher door opens automatically, which shortens the program time and improves the drying results. Wait until the dishwasher indicates that the program has ended and the dishes have cooled before unloading the dishwasher. (If the dishwasher is built-in the surrounding furnishings must be resistant to any condensation from the dishwasher.)</p> <p><i>Not available for: Hygiene 70°, Self-clean, Intensive 70°, Glass 40°</i></p>
F--	Error readout		<p>Any error messages.</p> <p>When contacting the service department, you may be asked to provide the most recent error messages.</p>
rSt	Restore factory defaults		<p>Restores all settings to the factory defaults.</p> <p>Select rSt and press ▷ ◀.</p>
End	Exit		<p>To exit the dishwasher's settings menu, select End and press  or wait for three seconds.</p>

Care and cleaning

✳ Top up with rinse aid

When the rinse aid needs topping up, the above symbol lights on the display.

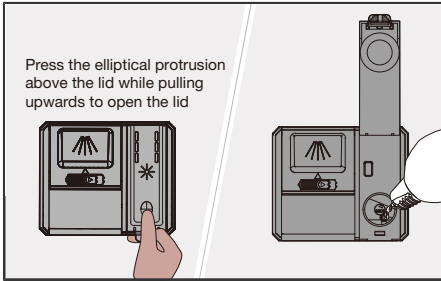

1. Open the rinse aid compartment lid.
2. Carefully top up with rinse aid to the level marked **MAX**.
3. Wipe up any splashes of rinse aid around the compartment.
4. Close the lid firmly.

After topping up, it may take a while before the symbol goes out.

⚖ Top up with salt

When the salt needs topping up, the above symbol lights on the display.

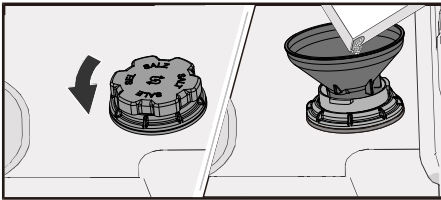

1. Remove the salt compartment lid by turning it anticlockwise.
2. Place the funnel supplied with the dishwasher in the salt compartment top-up hole. (Water is only needed the first time.)
3. Add enough salt to fill the salt compartment (max. 750 gram). Use special dishwasher salt.
4. Wipe up any excess salt so that the lid can be screwed on firmly.

After topping up, it may take a while before the symbol goes out.

⚠ **WARNING!**

In order to avoid rust stains a dishwashing program must be started immediately after adding salt.

Never pour dishwasher detergent into the salt compartment. This destroys the water softener!

Clean the filter

The filter traps larger food particles, which cannot get past the drainage pump. Empty the filter when necessary. It should be cleaned at regular intervals depending on how often the dishwasher is used.

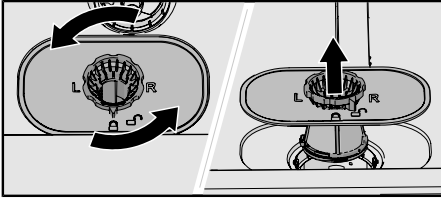

1. Turn the locking ring anticlockwise and lift the filter straight up.
2. Empty and clean the filter.
3. Refit the filter and turn the locking ring clockwise to its stop position. Check that the edges seal properly.

NOTE!

Dishwashing results may be affected if the filter is fitted incorrectly. The dishwasher must not be used without the filter in place!

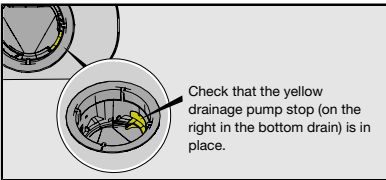

Cleaning the spray arms

Holes and bearings can sometimes become blocked. Remove any debris using a pin or the like. The spray arms also have holes underneath.

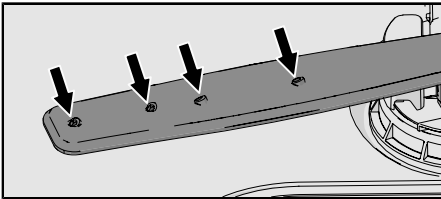

To facilitate cleaning you can remove the spray arms. Remember to fit them firmly back into place afterwards.

Upper spray arm

- Pull out the upper basket.
- Unscrew the spray arm bearings anticlockwise to remove the spray arm from the upper basket.

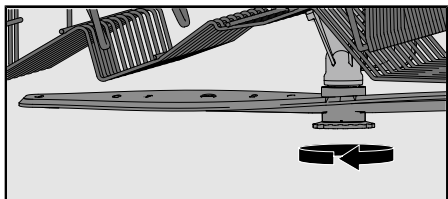

Lower spray arm

- Pull the lower spray arm straight up to release it.

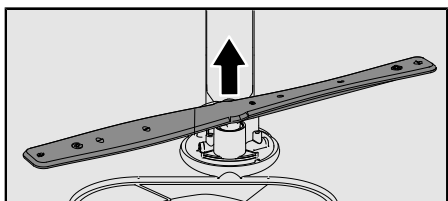

Clean the outside of the dishwasher

Door and door seal

Open the door. Clean the sides of the door and the door seal regularly with a slightly damp cloth. Clean the door seal at the lower front edge of the dishwasher with a washing-up brush.

Control panel

Keep the control panel clean. If necessary, wipe it with a dry or slightly damp cloth. Never use cleaning products – they may scratch the surface.

CLn - Run the Self-clean program

Dishwasher tub

The dishwasher tub is made of stainless steel and is kept clean through normal use (when used regularly).

If you have hard water, limescale deposits may build up in the dishwasher. If this happens, run the Self-clean program with two tablespoons of citric acid in the detergent compartment (with no dishes in the machine). Special dishwasher cleaners are also available on the market.

Remove blockages

Unblocking the drainage pump

If the dishwasher still contains water after the program has finished, something may be blocking the drainage pump, which results in the Water outlet fault error message.

1. Turn off the machine using ⏻ and remove the plug from the wall socket.
2. Remove the filter.
3. Scoop out the water from the dishwasher tub.
4. In order to inspect the drainage pump, remove the yellow drainage pump stop on the right in the bottom drain. (Use a pair of pliers if necessary.)
5. Turn the pump wheel located behind the drainage pump stop by hand. Carefully remove any sharp items, such as glass.
6. Refit the drainage pump stop. Refit the filter.

7. Plug the machine in again.

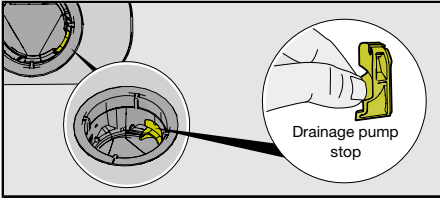

 **NOTE!**
Do not forget to refit the drainage pump stop.

Unblocking the inlet hose filter

If the water supply contains small particles, the outer filter on the inlet hose may become blocked, which results in the Water inlet fault error message.

1. Turn off the machine using  and remove the plug from the wall socket.
2. Turn off the water tap.
3. Unscrew the inlet hose.
4. Carefully remove the outer filter from the inlet hose and clean it.
5. Refit the filter and check that the gasket is correctly positioned.
6. Screw the inlet hose firmly into place.
7. Plug the machine into the wall socket and turn on the water tap. Allow the pressure to settle for a while and check that the connection is watertight.

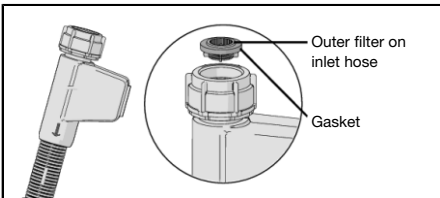

Troubleshooting

Error messages		Action
F11	Water outlet fault	See <i>Water remains in the dishwasher</i> in the table <i>Problem</i> below. If the problem persists, contact your nearest service centre.
F12	Water inlet fault	Check that the water tap is on. Check that the outer filter on the inlet hose is not blocked. See <i>Unblocking the inlet hose filter</i> in the chapter <i>Care and cleaning</i> . If the problem persists, contact your nearest service centre.
F13	Water level fault	Turn off the water tap and contact your nearest service centre.
F18	Diverter fault	Contact your nearest service centre.
F40	Inlet valve leakage	Turn off the water tap and contact your nearest service centre.
F41	Heater fault	Turn off the water tap. Remove the plug from the wall socket and contact your nearest service centre.
F42	NTC fault	Turn off the water tap and contact your nearest service centre.
F54	Overfilling water	Turn off the water tap and contact your nearest service centre. To avoid water leakage outside the dishwasher, do not remove the plug from the wall socket until the water tap on the supply line has been turned off!
F60	Communication fault	Contact your nearest centre.

Press  to clear the error message except for F54. After the dishwasher appears F54 error, it can only be turned off when the error is cleared.

Problem	Possible causes	Action
The control panel does not react when pressed.	You have pressed the control panel too soon after closing the door.	Wait a moment then try again.
	The door is open.	The control panel only reacts to use when the door is closed.
	Child lock or Automatic child lock is activated.	See the chapter <i>Using the dishwasher</i> .
	Dirt on the control panel.	Clean with a dry or slightly damp cloth.
Cannot close door.	The baskets are not correctly positioned.	Check that the baskets are correctly positioned horizontally.
		Check that the dishes are not blocking the baskets from sliding properly into place.

Problem	Possible causes	Action
The dishwasher does not start.	▶ ◻ has not been pressed.	Press ▶ ◻. The display starts counting down.
	The door is not properly closed.	Check.
	You have opened the dishwasher to add more dishes while a program is in progress.	Close the door and press ▶ ◻.
	Check whether the Delayed start option has been selected.	Press and hold ▶ ◻ for five seconds if you want to cancel the Delayed start option.
	The plug is not plugged into the wall socket.	Check.
	A fuse/circuit breaker has been tripped.	Check.
The dishes are not clean.	The spray arms do not rotate.	Check that the dishes are not blocking the spray arms.
	Spray arm holes or bearings blocked.	Clean the spray arms. See the chapter <i>Care and cleaning</i> .
	Unsuitable dishwashing program.	Select a program with a high temperature to dissolve grease on very dirty dishes, such as Intensive 70°.
	Incorrect detergent dosage.	Dose according to water hardness. Far too much or far too little detergent results in poorer dishwashing results.
	Old detergent. Detergent is a perishable product.	Avoid large packages.
	Dishes loaded incorrectly.	Do not cover porcelain with large bowls or the like. Avoid placing very tall glasses in the corners of the baskets. See the chapter <i>Loading the dishwasher</i> .
	Glasses and cups have toppled over during the program.	Place dishes to sit steady.
	The filter is clogged.	Clean the filter.
	The filter is not fitted correctly.	Check that the filter is fitted correctly. See the chapter <i>Care and cleaning</i> .
Drainage pump stop missing.	Check that the yellow drainage pump stop (on the right in the bottom drain) is in place. See the chapter <i>Care and cleaning</i> .	

Spots on stainless steel or silver.	Some foodstuffs, such as mustard, mayonnaise, lemon, vinegar, salt and dressings, can cause spots on stainless steel if left for too long.	Rinse off these types of foodstuffs if not starting the dishwasher immediately. Consider using 1h 65° with the Speed wash option.
	All stainless steel can cause spots on silver if they come into contact during dishwashing. Aluminium can also cause spots on dishes.	In order to avoid marks and tarnishing, separate dishes made from different metals, such as silver, stainless steel and aluminium.
Spots or films on the dishes.	Incorrect rinse aid dosage setting.	See the chapter <i>Settings</i> .
	The setting TAB is activated and all-in-one detergent with insufficient drying effect is being used.	Switch all-in-one detergents or deactivate the TAB setting and top up with salt and separate rinse aid. See <i>Rinse aid</i> in the chapter <i>Settings</i> .
	Salt compartment empty.	Top up with salt. See the chapter <i>Before washing for the first time</i> .
	Incorrect water softener setting.	See <i>Water hardness</i> in the chapter <i>Settings</i> .
	The water softener is leaking salt.	Check that the salt compartment lid is properly tightened. Otherwise contact your nearest service centre.
	Too high temperature and/or too much detergent can cause etching on crystal. Unfortunately, this cannot be repaired, only prevented.	Wash crystal at a low temperature and with a conservative amount of detergent. Contact the detergent manufacturer.

Problem	Possible causes	Action
Rattling sound when dishwashing.	The dishes are not correctly placed or the spray arms are not rotating.	Check that the dishes are placed securely. Spin the spray arms to make sure they can rotate.
Water remains in the dishwasher.	The filter is clogged.	Clean the filter.
	The filter is not fitted correctly.	Check that the filter is fitted correctly. See the chapter <i>Care and cleaning</i> .
	Debris in the drainage pump.	Clean the drainage pump. See the chapter <i>Care and cleaning</i> .
	Drainage pump stop missing.	Check that the yellow drainage pump stop (on the right in the bottom drain) is in place. See the chapter <i>Care and cleaning</i> .
	Kink in drainage hose.	Check that the hose is free from kinks and sharp bends.
	Blocked drainage hose.	Disconnect the drainage hose where it connects to the sink unit's water trap. Check that no debris has fastened and that the connection has an inner diameter of at least 14 mm.
Bad odour in dishwasher.	Dirt around the seals and in corners.	Clean with washing-up brush and low foaming cleaner.
	Low temperature programs have been selected for a prolonged period.	Run a program with a high temperature once or twice a month. Or run a self-cleaning program. See <i>Self-clean</i> in the chapter <i>Using the dishwasher</i> .
Grease deposits in the dishwasher.	Low temperature programs have been selected for a prolonged period.	Select a program with a high temperature to dissolve grease on very dirty dishes, such as Intensive 70°. Or run a self-cleaning program. See <i>Self-clean</i> in the chapter <i>Using the dishwasher</i> .
The dishes are not dry enough.	The Auto Dry setting has not been activated.	Activate the Auto Dry setting. See the chapter <i>Settings</i> .
	The dishwasher is not fully loaded.	Fully load the dishwasher.
	Rinse aid needs topping up or dosage is set too low.	Top up with rinse aid or increase the rinse aid dosage setting.
	The setting TAB is activated and all-in-one detergent with insufficient drying effect is being used.	Switch all-in-one detergents or deactivate the TAB setting and top up with salt and separate rinse aid. See <i>Rinse aid</i> in the chapter <i>Settings</i> .

Installation

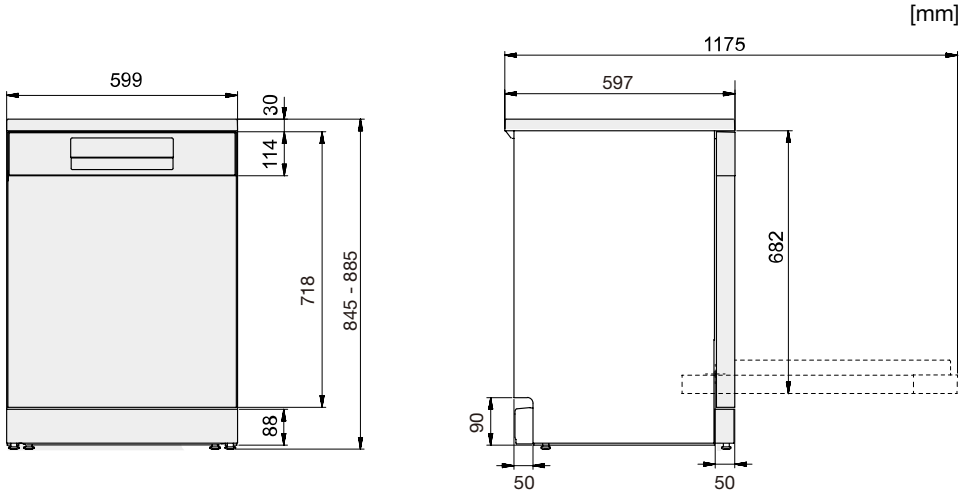

Nominal dimensions. Actual measurements may vary.

Safety instructions

- Connections to electricity, water and drainage must be performed by a qualified professional.
- Always follow applicable regulations for water, drainage and electricity.
- Take care during installation! Wear protective gloves! There must always be two people!
- Place a drip tray on the floor beneath the dishwasher to prevent damage from any water leaks.
- Before screwing the dishwasher into place, test the dishwasher by running the 1h 65° program with the Speed wash option. Check that the dishwasher fills with water and drains. Check also that none of the connections leak.

WARNING!

Turn off the water supply when installing the dishwasher!

The plug must be disconnected or power to the socket turned off while the work is carried out!

Transport protection for the door

Do not forget to remove the transport protection for the door when unpacking the dishwasher.

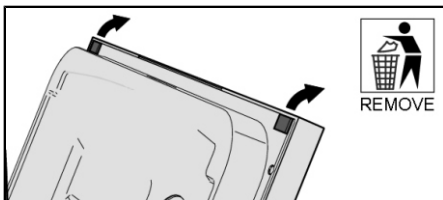

Placing the dishwasher

The dishwasher can be installed under a worktop or freestanding. Make sure the area on which the dishwasher is to be installed is firm.

- When the dishwasher is installed with its worktop, the build-in measurements are shown in the illustration.

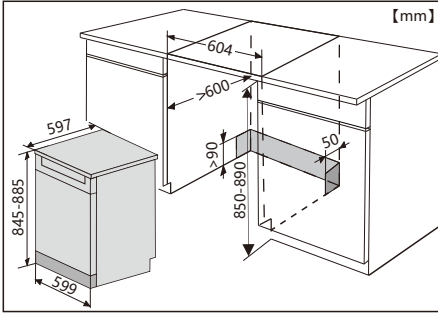

- When the dishwasher is installed in a recess without its worktop, the build-in measurements are shown in the illustration.

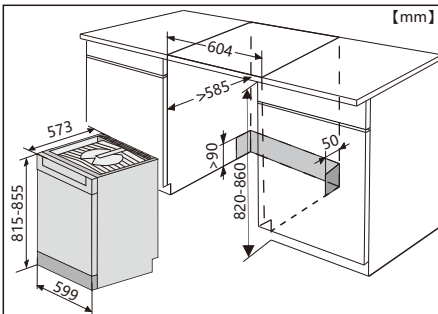

Adjust the height and slide the dishwasher into place

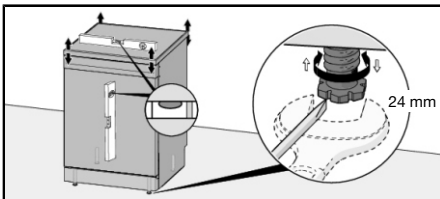

Freestanding

- Make sure the area on which the dishwasher is to be installed is firm. Adjust the dishwasher's height using the four feet so that the dishwasher is level. The dishwasher may lean no more than 5 mm.

Built-in

1. Start by measuring the height from the floor to the bottom edge of the worktop.
2. Measure the height from the floor to the top edge of the dishwasher.
3. Adjust the dishwasher's feet by turning them clockwise to raise or anticlockwise to lower the machine.
4. Check that there is an air gap of at least 3 mm between the underside of the worktop and the top edge of the dishwasher.
5. Slide the dishwasher into place.
 - Pull through the drainage and supply hoses when the machine is slid into place.
 - Check that the hoses have no kinks or sharp bends, and check that there is nothing that can damage the hoses.

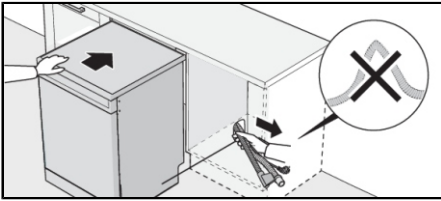

- Check that the machine is installed such that the door opens freely, otherwise door lock functionality may be disrupted.
6. Make any final adjustments to the front feet (the dishwasher may lean no more than 5 mm).

The dishwasher can also be installed in a recess without its worktop. See Remove dishwasher worktop.

Drainage connection

This dishwasher is suitable for installing in a raised recess (to attain an ergonomic working height). This means that the dishwasher can be placed so that the drainage hose runs to a lower level than the bottom of the dishwasher, such as by routing it directly to a floor drain. The dishwasher is fitted with an integrated anti-siphon device to prevent the machine from being emptied of water during the wash cycle.

The drainage hose can also be connected to a connection nipple on the sink unit's water trap. The connection nipple must have an internal diameter of at least 14 mm.

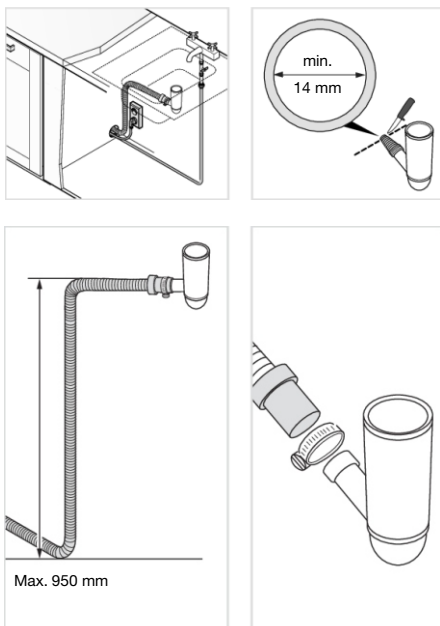

The drainage hose may be extended by a maximum of 3 m (the total length of the drainage hose must not exceed 4.5 m). Any joins and connecting pipes must have an internal diameter of at least 14 mm. However, the drainage hose should ideally be replaced with a new hose without joins.

No part of the drainage hose may be more than 950 mm above the bottom of the dishwasher.

Attach the drainage hose with a hose clamp. Ensure that the drainage hose has no kinks.

Connection to water supply

Use only the inlet hose supplied with the dishwasher. Do not re-use old or other spare hoses.

The supply pipe must be fitted with a water tap (stopcock). The water tap must be easily accessible, so that the water can be shut off if the dishwasher has to be moved.

Once the installation is complete, turn on the water tap and allow the pressure to settle for a while. Check that all connections are watertight.

Connection to cold water supply

Connect the dishwasher to the cold water supply if the building is heated using oil, electricity or gas.

Connection to hot water supply

Connect the dishwasher to the hot water supply (max. 60 °C) if the building is heated using an energy-efficient means such as district heating, solar power or geothermal power. Choosing a hot water connection reduces the dishwasher's energy consumption.

NOTE!

Do not exceed the permitted water supply temperature. Certain materials used in some cookware cannot withstand high heat. See *Fragile dishes* in the chapter *Loading the dishwasher*.

Electrical connection

Information about the electrical connection can be found on the serial number plate. This specification must match the electricity supply.

The dishwasher must be connected to an earthed socket.

The electric wall socket must be placed outside of the installation area to be easily accessible after installing the dishwasher. Do not use an extension cord!

Remove dishwasher worktop

The dishwasher can be installed in a recess without its worktop. If the dishwasher's worktop is removed, the dishwasher must be installed under a separate worktop.

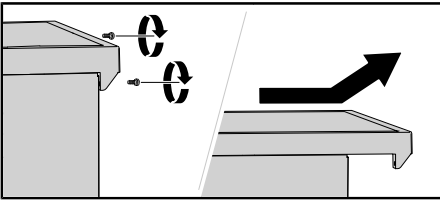

Service

Read the chapter Troubleshooting before contacting the service centre. If you have encountered a problem that you cannot resolve, please contact your nearest service centre for professional help, see www.hisense.com. Our website also has information about spare part availability and what you can repair yourself.

When making contact, provide the details on the serial number plate. Include the article number (1) and the serial number (2).

Please note that non-professional repairs may risk user safety and affect the warranty.

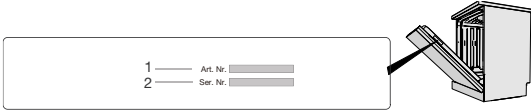

Technical data and energy labelling

Technical data

Height:	845-885 mm
Width:	599 mm
Depth:	597 mm
Weight:	43 kg ¹⁾
Number of standard place settings:	14 ²⁾
Water pressure:	0.03-1.0 MPa
Rated voltage:	220-240V~ 50Hz
Rated power:	1900 W

1) Weight can vary due to different specifications.

2) In accordance with the EN 60436 standard.

Information for consumers

Information about your product can be found at global.hisense.com, where you will also find a link to the European Product Database for Energy Labelling, EPREL. Or else visit <https://eprel.ec.europa.eu> directly. Follow the instructions to search by model name.

See the information on the serial number plate. Make a note of the model name (3).

Information for test institute

Information for comparability tests in accordance with EN 60436

Capacity: 14 place settings

Position of the upper basket: lower position

Program: Eco

Rinse aid setting: 05

Powdered detergent quantities: 4g prewash + 18g main wash

1. Upper baskets:

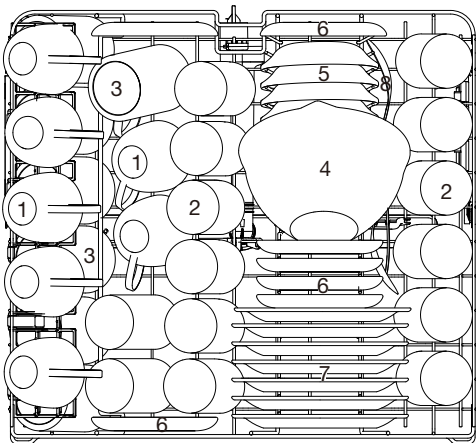

Number	Item
1	Cup
2	Glass
3	Mug
4	Glass bowl
5	Dessert bowl
6	Saucer
7	Melamine dessert plate
8	Serving spoon

2. Lower baskets:

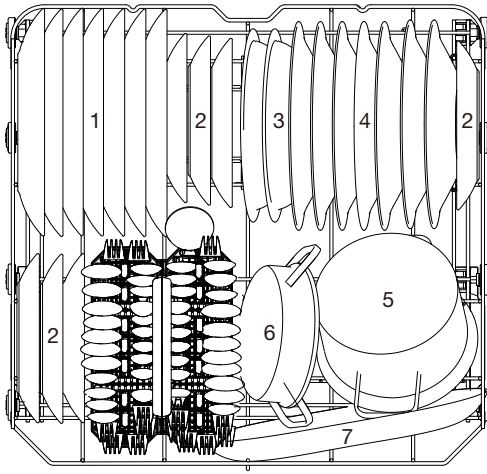

Number	Item
1	Dinner plate
2	Dessert plate
3	Melamine bowl
4	Soup plate
5	Small pot
6	Oven pot
7	Oval platter

3. Cutlery baskets:

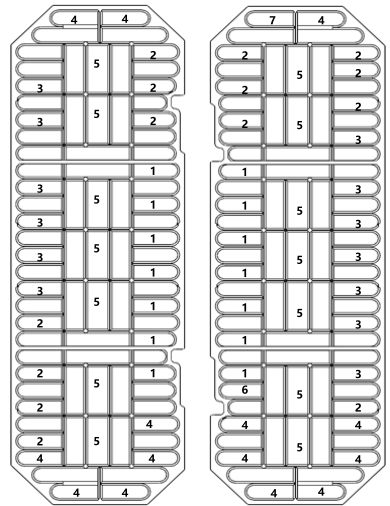
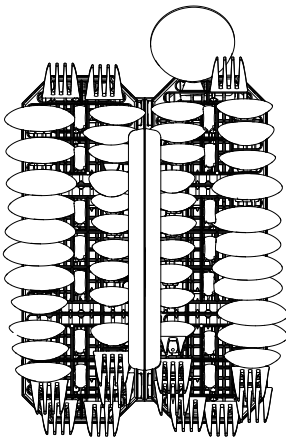

Number	Item
1	Tea spoons
2	Dessert spoons
3	Soup spoons
4	Forks
5	Knives
6	Serving fork
7	Gravy ladle

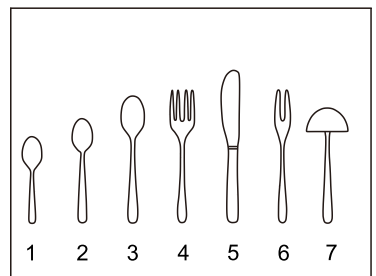

Hisense

We reserve the right to make changes.

12222203-A