

Hisense

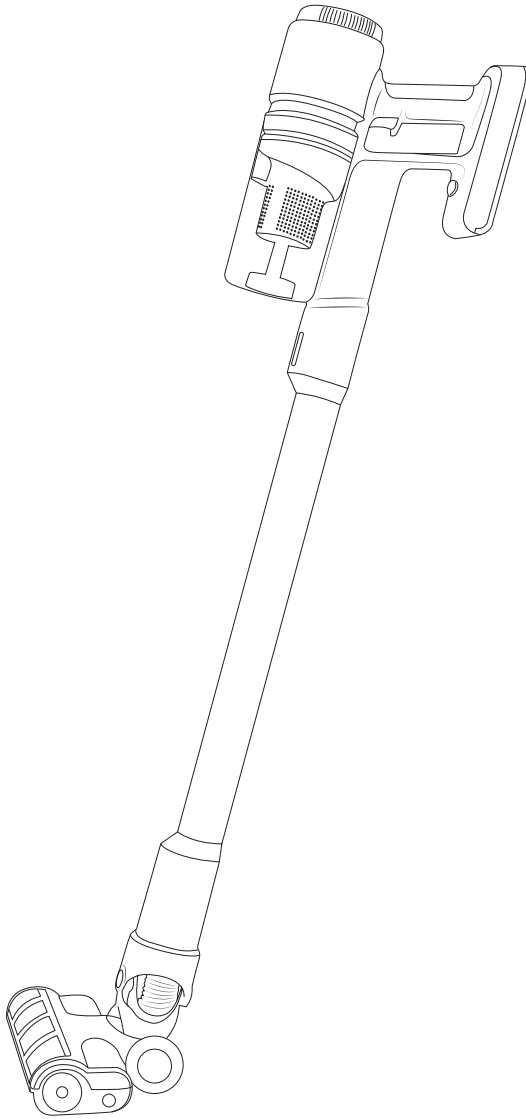

CORDLESS
VACUUM
CLEANER
HI-MOVE IV
HVC6134xx

QUICK GUIDE

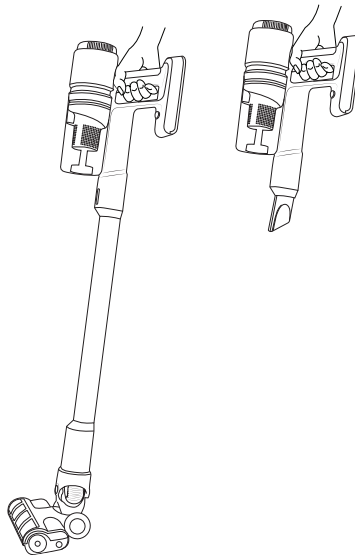
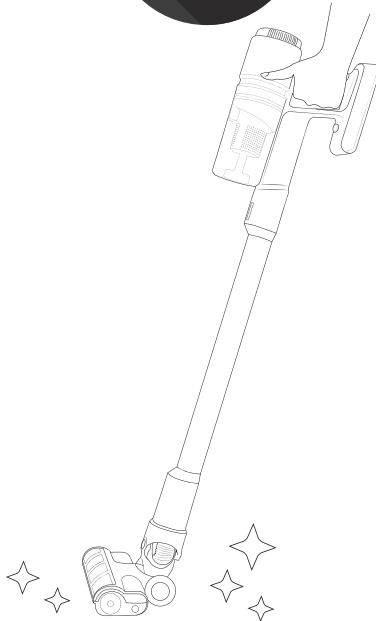

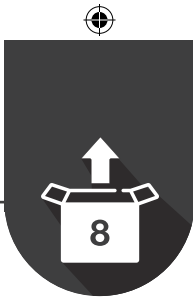

1. Motor unit with housing, battery and dust container

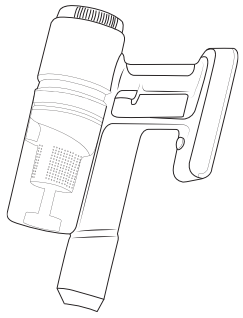

2. Suction hose



3. Motorized electric brush

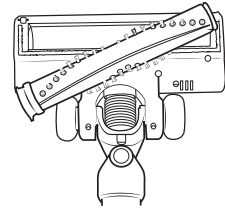

4. Crevice nozzle

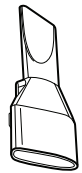

5. Dusting brush



6. Wall-mounted base with adapter and power cord

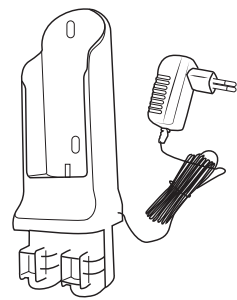

7. 2 x screws

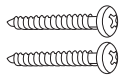

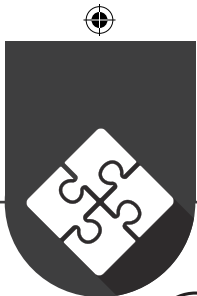

1.

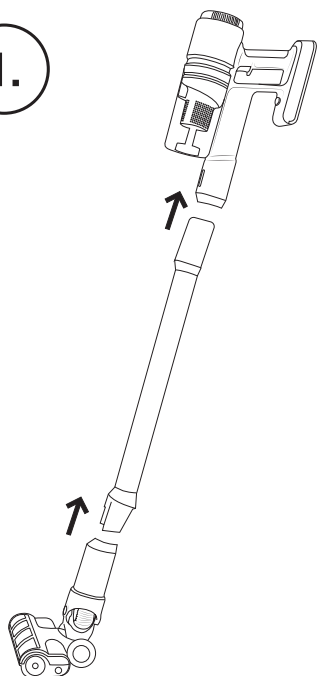

2.

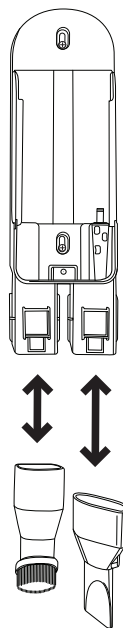

3.

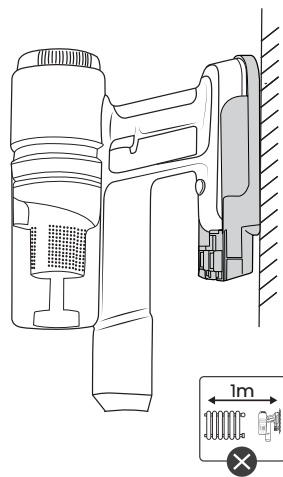
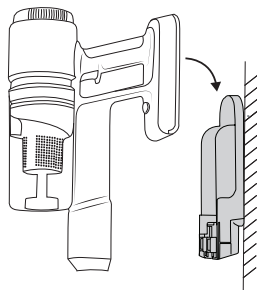
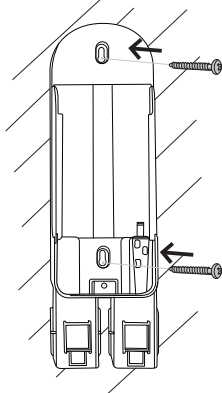



-
-
-
-

-
-
-
-
-
-

-
-
-



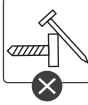
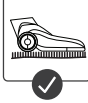
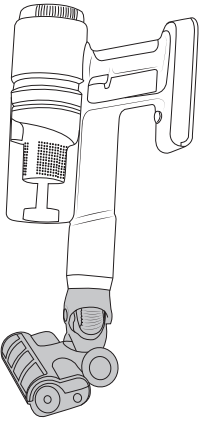
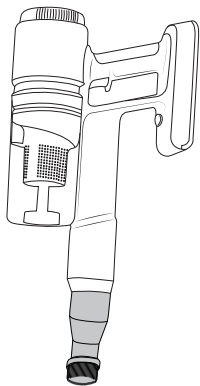
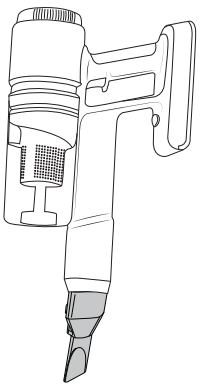



a

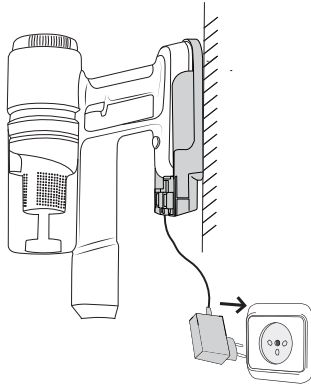

b

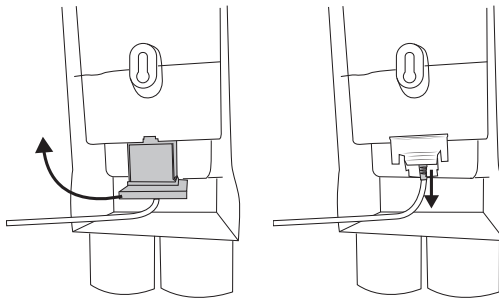
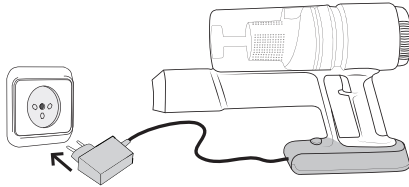

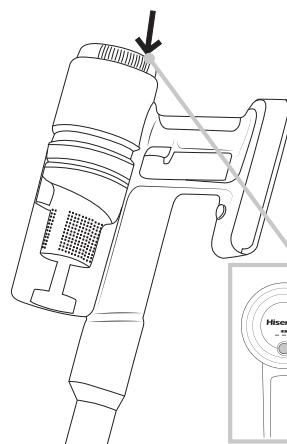
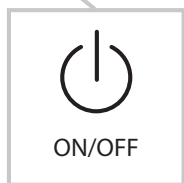
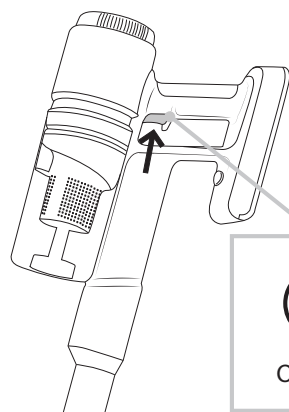
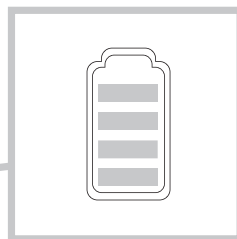
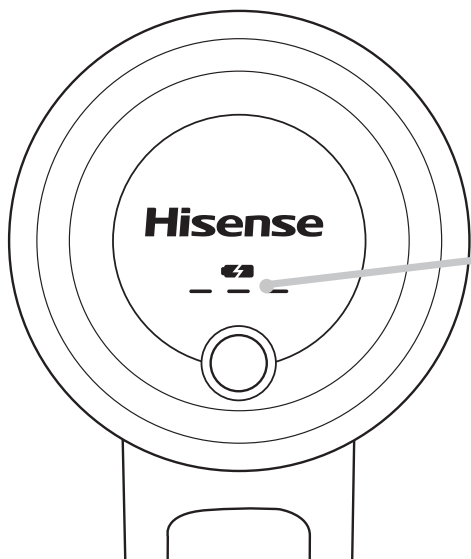

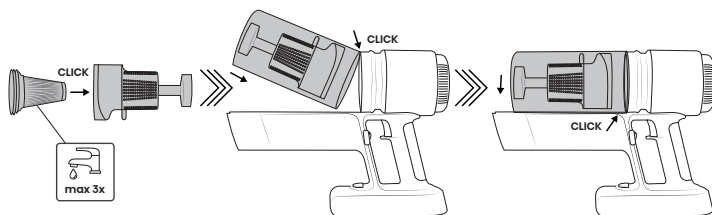
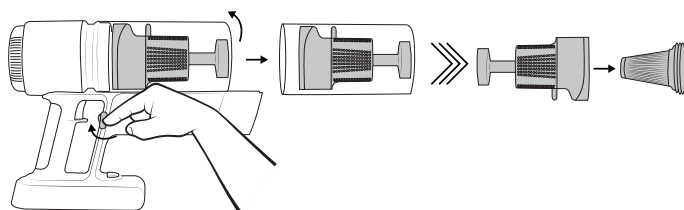
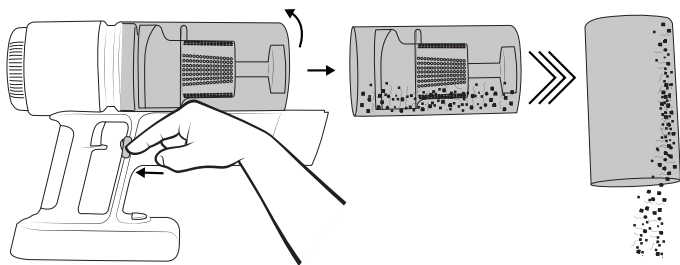

Filter quick clean

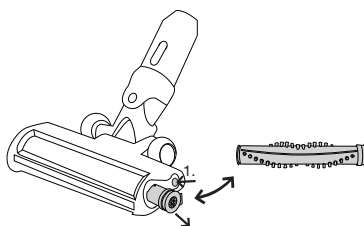
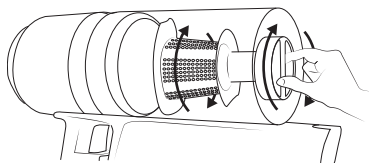



1.

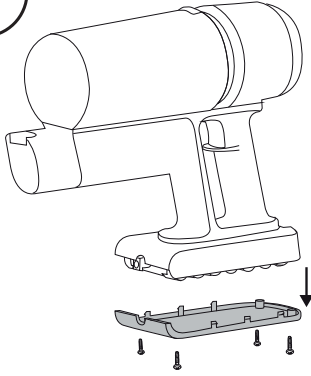

2.

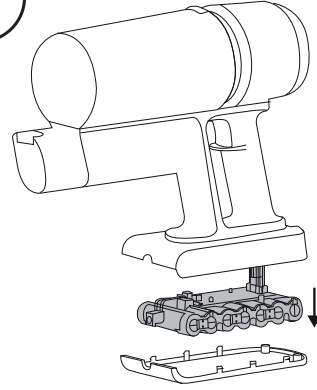

3.

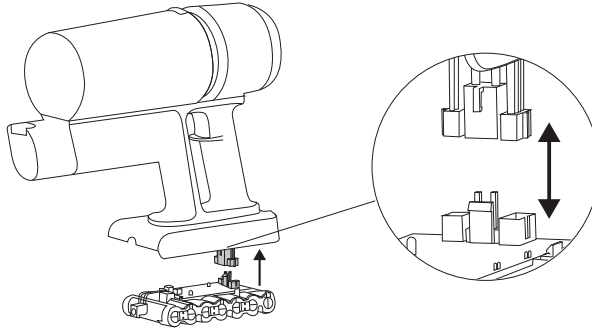

4.

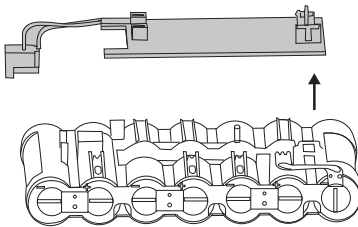

5.

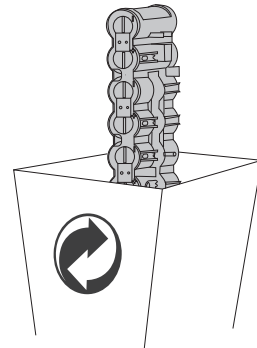



Hisense