

E-Manual MT9900 VIDAA U6 EUEM

Contents

First-Time Use

Using the E-Manual.....	3
Home Screen.....	3
Connecting to the Internet.....	6
Setup via Mobile Phone.....	8
Prepare Live TV.....	8
Using External Devices.....	9
Using the TV Voice Service.....	9

Enjoy Live TV

Channel Scan.....	11
Live Menu.....	12
Channel Edit.....	14
Programme Info.....	16
Programme Guide (EPG).....	17
Programme Recording (PVR).....	18
Reminder.....	21
Timeshift.....	22
HbbTV.....	23
Learn about Live TV Support Settings.....	23

Benefits of Smart TV

Using a VIDAA Account.....	25
Voice Service Setup.....	25
Content Sharing.....	30
Using Apps.....	31
Using the Art App.....	31
Enjoy the Internet.....	32
Data Protection and Security.....	33
Usage Mode Setup.....	33
Using the Mobile App.....	34

Connecting to External Devices

Remote & Accessories.....	35
Connecting Bluetooth Devices.....	37
Connecting a Set Top Box.....	38
Connecting a Blu-ray or DVD Player.....	38
Sharing your Smart Phone/Computer Screen on the TV.....	38
Using AirPlay and HomeKit.....	39
Connecting USB Devices.....	40
Connecting Headphones.....	41

Contents

Connecting Audio Visual (AV) Devices.....	41
Connecting Speakers or Other Audio Receivers.....	42
Connecting a Digital Audio System with ARC/eARC.....	43
Connecting a PC.....	44

Settings Overview

Picture.....	45
Sound.....	49
Network.....	54
General.....	56
Support.....	59
Using Parental Controls.....	61
Reset to Factory Default.....	61

Entertainment

Game.....	62
FreeSync.....	62
Sports.....	62
Media.....	63

Accessibility Features

Accessibility Menu Setup.....	66
Audio Type Setup.....	66
Dialogue Enhancement.....	66
Subtitle Setup.....	66
Screen Magnification.....	67
Voice Guide.....	67

Troubleshooting

FAQ.....	68
TV Status Diagnosis.....	75
Remote Control Service.....	76
Picture Issues.....	76
Sound Issues.....	77
Network Issues.....	78
Channel and Broadcast Issues.....	78
External Device Connection Issues.....	79
HDMI & CEC Issues.....	79
Media Files.....	80
Voice Service Issues.....	80
Other Issues.....	80

First-Time Use



Using the E-Manual

View the embedded E-Manual that contains information about your TV's key features.





Disclaimer:

Instructions and images through this manual are only for reference and may differ from the actual product.



Launch the E-Manual

Press  /  button on your remote control and select  **Settings > Support > E-Manual**.

Enter the Home screen of the E-Manual.

Press  /  button on your remote control and select **TV**, then press  /  button on your remote control and select **E-Manual**.

Enter **Enjoy Live TV** chapter to learn more about how to set up Live TV features.

Press  /  button on your remote control and select **Connection Guide**.

Enter **Connecting to External Devices** chapter to learn more about how to connect external devices to your TV and how to set up.

Note:

- The black background icon indicates the button on the remote control.
- The grey background icon indicates the icons on the TV screen for selecting.

Use the Buttons in the E-Manual

Search

Search for the product feature information, the E-Manual will provide all the titles and content that contains the search information.

QR Code

Scan the QR Code with your Smart Phone to open the E-Manual on your device.

Try Now button

Select **Try Now**, and it will guide you to the corresponding TV menu for trying the function.

Home Screen

All TV functions can be accessed from the Home screen.

First-Time Use

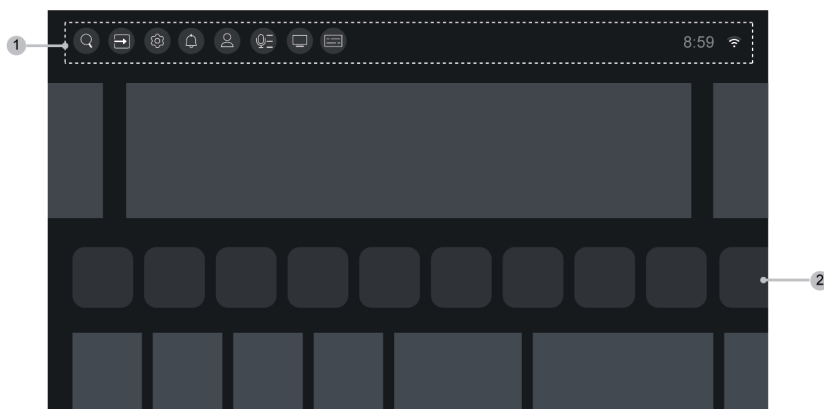



1. Navigation bar
2. Apps

Note:

- Indicators or icons may vary depending on models/countries/regions.

Display the Home Screen

Press  /  button on your remote control to enter the Home screen.

To exit the Home screen, press **INPUT** /  button on your remote control or use the navigation buttons to move the focus to the  **Input** icon on the top of the screen, press  button to enter and select your desired input source.

Use the Navigation Bar

The navigation bar refers to indicators and icons on the top of the Home screen.

Note:

- Indicators or icons may vary depending on models/countries/regions.

Search

Search the content you want.

Input

Select the input source depending on the device you have connected to your TV.

Settings

Manage TV configuration.

Notifications

Allow pop-up notifications to appear for useful information and events that occur with your TV, including: **Advertising, New Arrivals, Warnings and Legal Statements, System Messages** and **Alexa Notification**. You can enable/disable each of these notifications at Settings in the notification centre.

You can view the list of event messages generated by the TV.

First-Time Use

To delete all notifications, select **Clear All**.

Note:

- The Alexa Notification may not be applicable in some models/countries/regions.
- When you sign into your VIDAA account, please find Notifications in VIDAA Account on the Home screen.

VIDAA Account

A VIDAA account provides all the best features of your Smart TV and ensures that all services are kept up to date.

For more information about VIDAA account, please refer to [Benefits of Smart TV > Using a VIDAA Account](#) in this manual.

Voice

Quick access to **Voice Service**. For more information, please refer to [Benefits of Smart TV > Voice Service Setup](#) in this manual.

Guide

Quick access to Guide. For more information, please refer to [Enjoy Live TV > Programme Guide \(EPG\)](#) in this manual.



Live TV

Quick access to Live TV. For more information, please refer to [First-Time Use > Prepare Live TV](#) in this manual.

Time

You can always view the current time at the top of the Home screen.

Network

Connect your TV to the Internet through a wireless connection  or an Ethernet cable  , and the corresponding icon will appear.



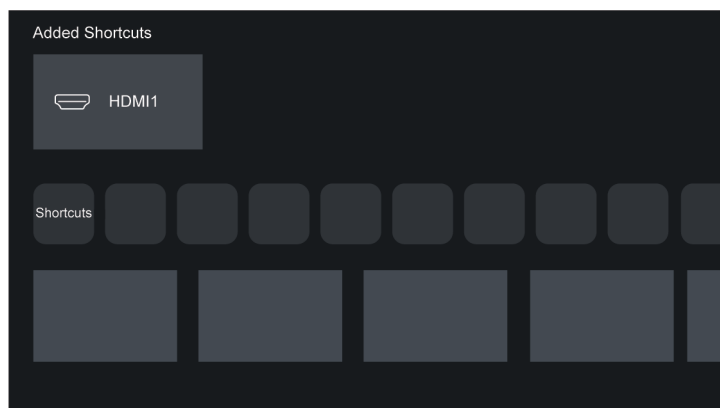

Use the Shortcuts

You can add inputs, channels and websites to the Home screen to have quick access to them for your convenience.



First-Time Use





Add and remove inputs

1. Press **INPUT** /  button.
2. Move the focus to an input you want to add to the Home screen and press  /  > **Add to home** >  .
The input icon will appear in Shortcuts on the Home screen.

Note:

- Some options from the input source page cannot be added to the Home screen.
- To remove the input from Shortcuts, move the focus to the shortcut, then press and hold the  button on your remote control.

Add and remove channels

1. In Live TV, press  /  button to access the channel list.
2. Press  /  button and press  button to tick channel(s) that you would like to add on the Home screen.
3. Select **Add to home**. The channel icon will appear in Shortcuts on the Home screen.

Note:

- To remove the channel from Shortcuts, move the focus to the shortcut, then press and hold the  button on your remote control.

Add and remove webpages

1. In Browser, visit a website you would like to add on the Home screen.
2. Use the D-pad to move the focus to the  **Menu** icon in the top of the Browser navigation bar and select **Add to home**.
3. Select **Add** and this webpage will appear in the Shortcuts on the Home screen.

Note:

- To remove webpages from Shortcuts, move the focus onto the shortcut page, then press and hold the  button on your remote control.

Connecting to the Internet

To get access to the Internet using a wired connection or connecting to an available wireless network.

Connect to a Wired (Ethernet) Network

To get access to the Internet using a wired connection, it is recommended to use a modem or router that supports Dynamic Host Configuration Protocol (DHCP). Modems and routers that support DHCP automatically provide the IP address, netmask, gateway, DNS Server 1 and DNS Server 2, so you do not have to enter them manually. Most home networks already have DHCP.

First-Time Use

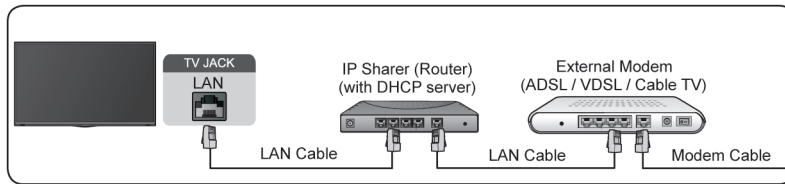

After connecting to a wired (Ethernet) network, press / button on your remote control, and select **Settings > Network > Network Configuration**.

Set the TV network by selecting **Network Configuration** and press button to enter the submenu.

- **Connection Type**

Choose a wired (Ethernet) network connection to access the Internet.

- **Ethernet**

Display network status.

- **IP Settings**

In **IP Version**, you can select from IPv4 and IPv6. When IPv4 is selected, the IP address, netmask, gateway, DNS Server 1 and DNS Server 2 will be automatically defined, or you can configure them manually for your network connection. When IPv6 is selected, all information is automatically defined.

Related information

[Network](#) on page 54

[Network Issues](#) on page 78

[My TV cannot connect to the network.](#) on page 70

Connect to a Wireless Network

To connect to an available wireless network, make sure that you turn on your wireless router and have the wireless router's SSID and password before attempting to connect.

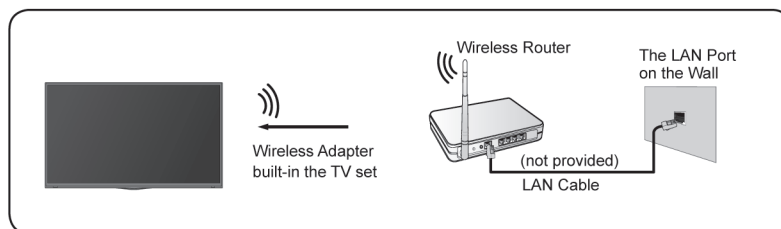

To get access to the Internet using a wireless connection, press / button on your remote control, and select **Settings > Network > Network Configuration**.

Set the TV network by selecting **Network Configuration** and press button to enter the submenu.

- **Connection Type**

Choose a wireless network connection to access the Internet.

First-Time Use

- **Advanced Settings**

Configure the advanced wireless network settings for the TV.

- **Add**

You can add a wireless network.

- **Refresh**

Refresh wireless network.

Note:

- If no wireless router is found, select **Add** and enter the network name in the SSID.
- If no wireless router is found, select **Refresh**.

 **Related information**

[Network](#) on page 54

[Network Issues](#) on page 78

[My TV cannot connect to the network.](#) on page 70

Setup via Mobile Phone

When you turn on the TV for the first time, the TV will support setup via your smart device by scanning the QR code.

If you scan the QR code to allow setup via the mobile app, setup of the TV will be more efficient.

Before performing setup with the mobile app, please make sure your mobile device has Bluetooth activated and is connected to the same Network as your TV.

Note:

- The setup above is for referencing purpose and may differ depending on models/countries/regions.

Prepare Live TV

Connect satellite/antenna/cable to the TV

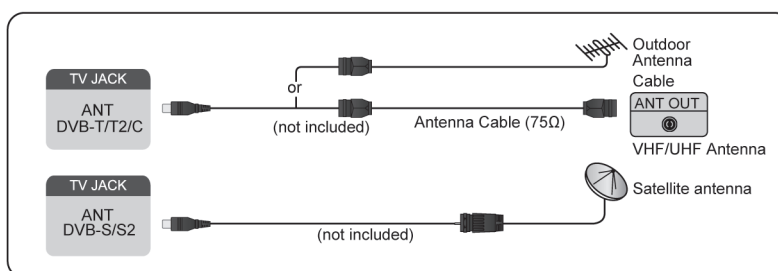



Note:

- TV jacks may vary and satellite/antenna/cable function may not be applicable in some models/countries/regions.
- You may also connect devices that can receive broadcast signals such as a Set Top Box.

First-Time Use

Start auto scan or manual scan

1. Press **INPUT** /  button on your remote control and select **TV**.
2. Press  /  button on your remote control and select **Settings > Channel > Auto Scan/Advanced Settings > Manual Scan**.





Related information

[Channel Scan](#) on page 11

Using External Devices







Access to connected external devices including wireless connected devices.

Switch between external devices connected to the TV



1. Press **INPUT** /  button on your remote control or press  /  button to move the focus to the  **Input** icon on the top of the Home screen, press  button to enter.
2. Select your desired input source.

Edit the name of input sources

Method 1:

1. Press **INPUT** /  button on your remote control or press  /  button to move the focus to the  **Input** icon on the top of the Home screen, press  button to enter.
2. Move the focus to an input source and press  /  button on your remote control.
3. Select **Rename**.

Method 2 (for some models):

Press  /  button on your remote control, and select  **Settings > System > Advanced Settings > Input Labels** to edit the name of input sources.







Note:

- Some input sources cannot be renamed.

Using the TV Voice Service

Select Voice Service on the TV

To access the Voice Service and select a voice assistant:

- press  /  button on your remote and select  **Voice** icon in the navigation bar;
- or press  button on your remote control;
- or press  /  button to select  **Settings** icon, and select **System > Voice Service**.

Use the remote microphone

You can enjoy interacting with voice assistant using your voice by just pressing and holding the  button on your remote control. Alternatively, by enabling the physical switch on the side of the remote control, the TV can be controlled using the wake-up words to call up the voice assistant completely hand free.

First-Time Use

Note:

- Voice Service feature may not be applicable in some models/countries/regions.
- Some remote controls may not support hands-free voice control function.
- To use this function, End User License Agreement and corresponding Smart feature privacy policy/terms and conditions may be required to be agreed to.

 **Related information**



[Voice Service Setup](#) on page 25

Channel Scan

You can scan for channels automatically or manually.

Auto Scan

Automatic channel scan.

1. Press **INPUT** /  button on your remote control, and select **TV**.
2. In Live TV, press  /  button and select **Settings > Channel > Auto Scan**.

If no TV channels were saved before, you will be prompted to do a channel scan.

Satellite

- **Single satellite:** You can use single satellite if you only have one satellite installed.
- **DiSEqC:** You can choose DiSEqC if you have DiSEqC equipment. Up to four satellites in DiSEqC 1.0 mode can be installed.

If you are using a motorised antenna, you can use DiSEqC 1.2 mode.

- **Unicable:** If your home is equipped with Unicable satellite distribution, you should use this option.

Please make sure that you know the Unicable band and frequency to be used. The information should be available on the equipment or the landlord can provide it.

Antenna

- **Channel:** Select from **All Channels** or **Free Channels**. This option may not be available depending on countries/regions/operators.
- **Scan Mode:** Select from digital channels only (DTV), digital and analogue channels (DTV+ATV) or analogue channels only (ATV).

If you receive DVB-T or DVB-T2 signal, you can use DTV.

- **LCN:** Switch on/off LCN (Logical Channel Number).

Please note that some operators are restricted to manually change the channel order. If you switch off LCN, then the channel list can be edited after channel scan.

This function may not be applicable in some models/countries/regions.

Cable

- **Channel:** Select from **All Channels** or **Free Channels**. This option may not be available depending on countries/regions/operators.
- **Scan Mode:** Select from digital channels only (DTV), digital and analogue channels (DTV+ATV) or analogue channels only (ATV).
- **LCN:** Switch on/off LCN (Logical Channel Number).

Please note that some operators are restricted to manually change the channel order. If you switch off LCN, then the channel list can be edited after channel scan.

This function may not be applicable in some models/countries/regions.

Note:



- Satellite/antenna/cable function may not be applicable in some models/countries/regions.

Related information

[Prepare Live TV](#) on page 8



Manual Scan

Manually scan for channels for DTV or ATV.

1. Press **INPUT** /  button on your remote control, and select **TV**.
2. In Live TV, press  /  button on your remote control and select **Settings > Channel > Advanced Settings > Manual Scan**.

DTV Manual Scan

Manually scan for DTV services.

When the DTV Manual Scan screen appears, press  /  button to select **Antenna**, **Cable** or **Satellite** and configure corresponding settings. Then select **Start** to commence the search of that channel. When the signal has been received, the signal strength will be displayed on the screen.

ATV Manual Scan

Manually scan for ATV services.

- **Frequency:** Input the channel frequency you want.
- **Picture System:** Select the Colour System.
- **Sound System:** Select the Sound System.

Note:

- Satellite/antenna/cable function may not be applicable in some models/countries/regions.



Related information



[Prepare Live TV](#) on page 8

Live Menu



You can obtain quick access to the channel list, favourite channel list or use relevant features with ease when watching TV programmes.

Display Channel List

In Live TV, press  /  button on your remote control to display the Channel List menu.

Alternatively, in Live TV, press  /  button on your remote control and select **Channel List**.

Learn about channel list sub-menu

In Live TV, press  /  button on your remote control and press  button.

Enjoy Live TV

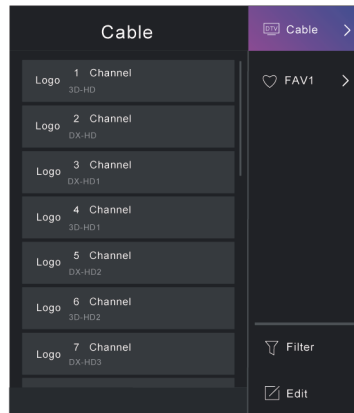

TV List

Display Live TV channel categories, such as **Cable** and **Antenna**.

FAV1-4

Display favourite lists 1 to 4.

Filter

Select channels by **Content**, **HD**, **Child Lock**, **Scrambled** and **Sort**.

Some options in **Filter** may not be available in some models/countries/regions.

Edit

Edit the channel list.

Note:

- The sub-menu options may vary depending on models/countries/regions.

☰ Related information

[Edit Channel List](#) on page 14

Display Favourite Channel List

In Live TV, press **OK**/**CHLIST** button on your remote control and press **➤** button, then select **FAV1-4** to display the favourite list.

☰ Related information

[Edit Favourite Channel List](#) on page 15

Learn about the On-Screen Menu

In Live TV, press **☰**/**☰** button to access the on-screen menu.

• Channel List

Quick access to Channel List.

• Guide

Quick access to Guide (EPG).

Enjoy Live TV

- **PVR**
Launch Schedule Recording.
- **Timeshift**
Launch Timeshift.
- **HbbTV**
Enable or disable HbbTV functionality for the current channel (only available for digital channels).
- **Subtitle**
Turn on Subtitle function or select subtitle option for digital broadcast content.
- **Recording List**
Quick access to Recording List.
- **E-Manual**
Enter **Enjoy Live TV** chapter to learn more about how to set up Live TV features.
- **Audio Only**
When you select this option, the screen will not display the picture. You can only listen to the audio.
Press any button except the power button, volume buttons and mute button to restore the picture.
- **Settings**
Set up picture, sound, channel, network, accessibility, system and support.

Note:

- Some menus above may not be available in some models/countries/regions.

Related information

[Edit Channel List](#) on page 14

[Programme Guide \(EPG\)](#) on page 17

[Programme Recording \(PVR\)](#) on page 18

[HbbTV](#) on page 23



[Subtitle Setup](#) on page 66

Channel Edit

Manually edit the channel list or favourite channel list to your preference.

Edit Channel List

Before you can edit the channel list, Channel Scan must be completed first.

In Live TV, press / button on your remote control and press  button to select a Live TV channel category such as Antenna or Cable, then use D-pad to select **Edit**.

Alternatively, in Live TV, press / button, select **Settings > Channel > Channel Edit**, and select a Live TV channel category such as Antenna or Cable.

Enjoy Live TV

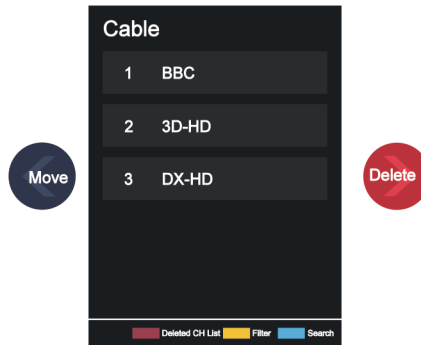

Manage the channels

- Press **OK** button on the selected channel, then a checkbox will appear. You can select multiple channels at the same time to move or delete.
- Move: Press **←** button to move the selected channel.
Moving the channels could be restricted by the operator. If you want to be able to move channels, it is not recommended to choose an operator during channel scan, and LCN should be set to Off.
- Delete: Press **→** button to delete the selected channel.
- Restore: Press **[RED]** button, or press **[Colour Menu] / [123]** button to display the colour menu and select RED to enter the list of deleted channels. Press **←** button to restore the deleted channel.
- Filter: Press **[YELLOW]** button or press **[Colour Menu] / [123]** button to display the colour menu and select YELLOW, the filter screen will pop up. Press **OK** button to select options, the channel list can then be updated.
- Search: Press **[BLUE]** button or press **[Colour Menu] / [123]** button to display the colour menu and select BLUE to search for a channel.

Export the channel list to USB

The current channel list can be exported to a USB storage device.

In Live TV, press **[Menu] / [List]** button on your remote control and select **Settings > Channel > Channel Edit > Export to USB**.

Import the channel list from USB

Previously exported channel lists can be imported via a USB storage device.

In Live TV, press **[Menu] / [List]** button on your remote control and select **Settings > Channel > Channel Edit > Import from USB**.

[Menu] Related information

[Channel Scan](#) on page 11

Edit Favourite Channel List

Before you can edit the favourite list, Channel Scan must be completed first.

Enjoy Live TV

Add a channel to a favourite list

You can add channels from various reception types to the favourite list.

1. In Live TV, press **OK**/**CHLIST** button to display the channel list.
2. Press **Menu**/**Menu** button and select the channel(s) you want to add to the favourite list.
3. Select **Add to Favourite** and choose from **FAV1-FAV4**.
4. Then, a heart-shape icon will appear next to the added channel.

Move or remove channels in a favourite list

In Live TV, press **OK**/**CHLIST** button on your remote control and press **Right**, select **FAV1-4**, then use D-pad to select **Edit**.

Alternatively, in Live TV, press **Menu**/**Menu** button on your remote control and select **Settings > Channel > Channel Edit**, then select **FAV1-FAV4**.

You can add, move, or remove favourite channels.

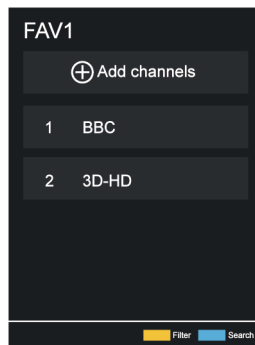

- Select **+** **Add channels** to add the selected channel to the favourite list.
- Select a channel in a favourite list, and press **Left** button to move it.
- Select a channel in a favourite list, and press **Right** button to remove it.

Menu Related information

[Channel Scan](#) on page 11

Programme Info

While watching TV programmes, press **Up**/**INFO**/**Info** button to load the programme info bar.

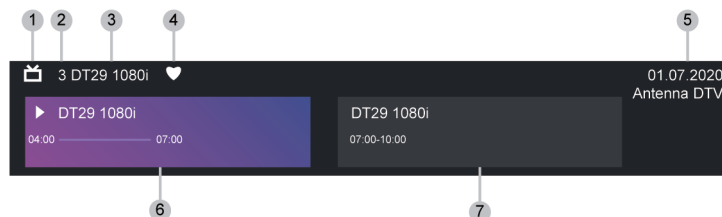

Enjoy Live TV

1. Channel logo
2. Channel number
3. Channel name
4. Indicator of Favourite
5. Date and time, and channel category
6. Current programme
7. Next programme

Note:

- The remote control buttons may vary depending on models/countries/regions.
- The image is only for reference and may differ from the specific product.

Programme Guide (EPG)

The Guide (EPG) provides a convenient way to check TV programmes for the upcoming 8 days. The information displayed by the Guide (EPG) is made available by the commercial television networks for digital channels only. The Guide (EPG) also provides a simple way to record your favourite programmes and a reminder function, which can switch channels automatically at scheduled times, so that you will not miss programmes of interest. The availability and amount of programme information will vary depending on the broadcaster.

Note:

- The Guide (EPG) function is only available for digital channels. Analogue channels are not supported.

Launch the Guide



In Live TV, press  button, or press  button and select **Guide (EPG)** to display programme guide.

Learn about the Guide menu

• Watch

In Guide (EPG), when a current programme is selected, press  > **Watch** to switch to the channel you want to see.



• PVR/Reminder

In Guide (EPG), press  button to select the channels. Press  button to select programme based on the time schedule.

Press  button to select **PVR** or **Reminder**.



For more information, please refer to [Enjoy Live TV > Programme Recording \(PVR\)](#) or [Enjoy Live TV > Reminder](#) in this manual.

Note:

- The PVR function may not be applicable in some models/countries/regions.
- **Scheduled**
In Guide (EPG), press  [RED] button or press  button to display the colour menu and select RED. This will display a list of scheduled reminders and recordings.

Enjoy Live TV



• Programme Colour

In Guide (EPG), press  [GREEN] button or press  /  button to display the colour menu and select GREEN. Use the colours to indicate different genres in the Guide (EPG) for quick and easy viewing.



Note:

- This function may not be applicable in some models/countries/regions.

• 24h-

In Guide (EPG), press  [YELLOW] button or press  /  button to display the colour menu and select YELLOW to select programmes of the previous day.

• 24h+

In Guide (EPG), press  [BLUE] button or press  /  button to display the colour menu and select BLUE to select programmes of the next day.

Programme Recording (PVR)

The PVR function allows you to easily record digital television content for later viewing.

Read before Recording Programmes

- To use PVR, you must connect a storage device for recording. PVR will not function if a data storage device has not been connected.
- The format of the storage device can be NTFS or FAT32. The storage space of your device should be no less than 2GB (for 15 minutes high-definition video). It is strongly recommended to use a USB mobile hard disk drive instead of a USB flash drive as the storage device.
- If the transfer rate of your hard disk is too slow, a pop-up notice will be displayed. In this case, you will need to use another disk with higher speed.
- PVR is only available for digital channels and does not support analogue channels.
- Some broadcasters may restrict the recording of programmes.
- If a recording is made from a locked channel, the system PIN will need to be input to playback the recorded content.
- Some channel-related configuration may conflict with background recording. In this case, a reminder window will pop up.
- The PVR function may not be applicable in some models/countries/regions.



Related information

[Connecting USB Devices](#) on page 40

Recording

Schedule Recording

In Live TV, press  /  button and select **PVR**.



Alternatively, press  /  /  button to load the info bar, and select a programme and choose **PVR**.

If your remote has  button, press it and use D-pad to select  to set up PVR.

You can select recording mode from time, manual stop and programme.

When you select time, you can set the booking time and period.

Enjoy Live TV

In Guide (EPG), press the  [RED] button or press  /  button to display the colour menu, select RED to view the scheduled recording. In the schedule recording list, you can readjust the reservation information that has been set.

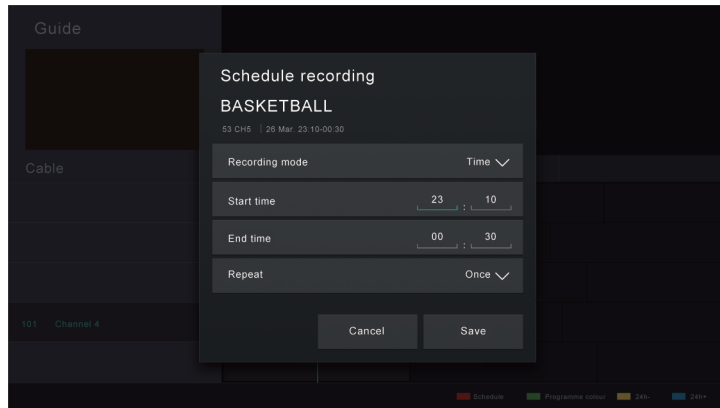



Standby Recording

If you press the power button during recording and select **Standby Recording**, your TV will go into standby mode, but the recording process will continue. If you press the power button again to wake up the TV, the recording process will not be affected. After recording, the recorded file will be automatically saved to the attached USB disk.

Background Recording

When you switch to an App or another source (e.g. HDMI) during recording, the recording process will continue. When the recording has completed, the recorded programme will be automatically saved to the attached USB disk.

If you want to manually stop recording, press **INPUT** /  button on your remote control and select **TV** to switch back to the channel that is currently being recorded, and then press  /  button and select  on-screen to stop.

Learn about the recording control bar

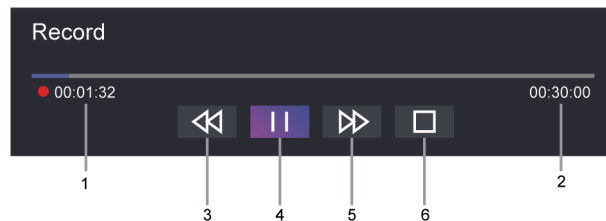

1. Recording time
2. Total time
3. Rewind
4. Pause / Play

Enjoy Live TV

5. Fast forward

6. Stop

Note:



- The PVR function may not be applicable in some models/countries/regions.

☰ Related information



[Schedule Recording cannot be used.](#) on page 74

Recording List

Access recording list

In Live TV, press / button on your remote control and select **Recording List**.



Watch recorded programmes

In Live TV, press / button on your remote control and select **Recording List > Recorded**.

Select a recorded programme in the recording list and press  button to watch it.

If you connect more than one storage device to the TV, **Recorded (Disk for Recording)** and **Recorded (All Disk)** are available on-screen to select.

Manage recording list

In Live TV, press / button on your remote control and select **Recording List > Recorded**.

You can sort or delete recorded programmes.

- Sort recorded programmes

Select **All**, and you can choose from the list to sort the recorded programmes.

Note:

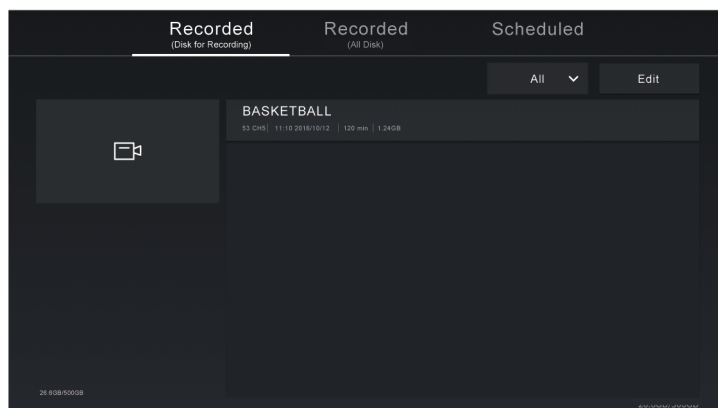

- This function may not be applicable in some models/countries/regions.
- Delete recorded programme

Select **Edit**, select a recorded programme in the recording list and press  button to delete it.



Enjoy Live TV

Manage schedule recording list

In Live TV, press / button on your remote control and select **Recording List > Scheduled**.

You can adjust the schedule recording information or cancel scheduled recordings. Schedule recording items are identified with  icons.

- Delete scheduled recording

Select **Edit**, select a scheduled recording in the schedule list and press  button to delete it.

- Edit scheduled recording

Select scheduled recording in the schedule list, then press  button to edit.

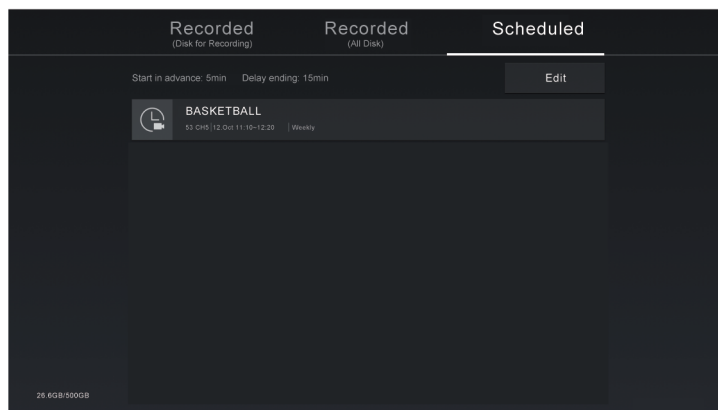









Note:

- The Recording List function may not be applicable in some models/countries/regions.

Reminder

Setup this feature to allow reminders to be displayed of future programmes.



Set up a Reminder

1. In Live TV, press  button, or press / > **Guide (EPG)** to display programme guide.
2. In Guide (EPG), press / button to select the channels. Press / button to select a programme that has not been aired.
3. Press  button to select **Reminder**.

Note:

- Reminder is only available for programmes that have not been aired yet.

Manage the Reminder List

In Live TV, press / button on your remote control and select **Recording List > Scheduled**.

You can change reminder information or cancel reminders. Reminder items are identified with  icons.

Enjoy Live TV

Delete reminder

Select **Edit**, select a reminder in the schedule list and press **>** button to delete it.

Edit reminder

Select reminder in the schedule list, then press **OK** button to edit.

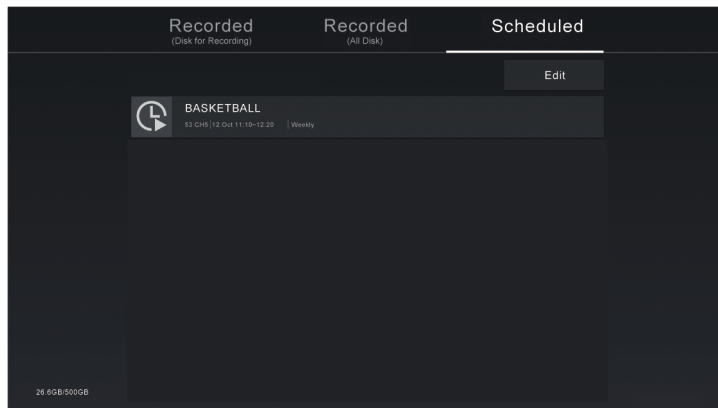

Timeshift

This option allows you to pause and rewind Live TV. This function operates by recording temporarily to a storage device. Please ensure your storage device is connected and there is enough free disk space, otherwise timeshift will not function.

In Live TV, press **≡** / **≡** button on your remote control and select **Timeshift**, then the playback bar will appear.





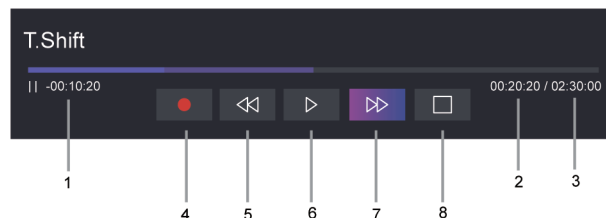

If your remote control has **⏸** button, press it and press **OK** button to launch Timeshift.

Press **🏠** / **🏠** button on your remote control and select **⚙️ Settings > System > Advanced Settings > PVR & Time Shift > Permanent Timeshift** and enable it, now you can also launch Timeshift just by pressing **<** / **>** button.



1. Unwatched time for buffered content
2. Current time
3. Total time

Enjoy Live TV

4.  Record: to convert a Timeshift to a live recording of the current broadcast channel. Select  and the programme content you have watched in Timeshift will also be saved to the storage device.
5.  Fast backward: you can choose 2×, 4×, 8× or 16×.
6.  Pause/  Play
7.  Fast forward: you can choose 2×, 4×, 8× or 16×.
8.  Stop Timeshift: to exit the function and watch the current broadcast.

Note:



- The Timeshift function does not support analogue channels.
- The storage space of the device should be no less than 2GB. It is strongly recommended to use a USB mobile hard disk drive instead of a USB flash drive as the storage device.
- The Timeshift function may not be applicable in some models/countries/regions.

Related information

[Connecting USB Devices](#) on page 40

HbbTV

Access service from providers through HbbTV.

Press  /  button on your remote control, and select  **Settings > System > Application Settings > HbbTV**.

Enable or disable HbbTV functionality for all channels (only available for digital channels).

In Live TV, press  /  button to select **HbbTV**.

Enable or disable HbbTV functionality for the current channel (only available for digital channels).



When HbbTV service is enabled and the programme supports HbbTV, follow the instructions on the TV screen to select the corresponding button on the remote control to access the service.

Note:

- This function may not be applicable in some models/countries/regions.
- Some channels may not support the HbbTV service.
- HbbTV cannot be used during Timeshift or PVR.



Learn about Live TV Support Settings

- Channel List Auto Update

Press  /  button on your remote control and select **Settings > Channel > Advanced Settings > Channel List Auto Update**.

Allow your TV to automatically update the channel list from the content provider.



- Programme Guide Auto Update

Press  /  button on your remote control and select **Settings > Channel > Advanced Settings > Programme Guide Auto Update**.

TV will automatically update the Programme Guide data overnight while in stand-by mode.



Enjoy Live TV

- CI+ Module Settings

Press  /  button on your remote control and select **Settings > Channel > Advanced Settings > CI+ Module Settings**.

Review the CI+ settings: Common interface, CI card PIN and CAM Profile Search. This function may not be applicable in some models/countries/regions.

- PVR & Time Shift

Press  /  button on your remote control and select **Settings > System > Advanced Settings > PVR & Time Shift**.

Format the external USB disk to support PVR and Time-Shift. When you connect more than one USB storage device to the TV, the one selected in **PVR Setup** or **Time Shift Setup** is initialized for starting recording or launching timeshift. The recorded programme will be saved in the selected storage device. When launching timeshift, programme will be recorded temporarily to the selected storage device.

You can add padding time to start recording before the event starts, or after the event has finished by delaying the end of recording depending on how much Padding time is added, this is setup in **Start in advance** or **Delay Ending**.

- Search

In Live TV, press  button to search for channels.

- Parental Control

Turn on Parental Control to prevent children from being able to view certain content. For more information, please refer to [Settings Overview > Using Parental Controls](#) in this manual.

- Picture and Sound

Adjust picture or sound mode or other advanced picture or sound settings. For more information, please refer to [Settings Overview > Picture](#) or [Settings Overview > Sound](#) in this manual.



Benefits of Smart TV

Using a VIDAA Account

Sign into your VIDAA account and create multiple profiles to receive personalised content according to your account preferences.

Sign into an account

Before signing into your VIDAA account, make sure your TV is connected to the network. For more about network settings, please refer to [First-Time Use > Connect to the Internet > Connect to a Wired \(Ethernet\) Network](#) or [Connect to a Wireless Network](#) in this manual.



1. After the network is connected, press  /  button on your remote control and select  **VIDAA Account** icon in the top navigation bar on the Home screen.
2. Register your device to your VIDAA Account. After entering your E-mail and password, select **Sign in**.
3. You can create a profile and give it a name.

If you forget your password and need to change the password, select **Forget Password?**, input your E-mail address and verification code, then create a new password.

Create a new account

If you do not have a VIDAA account, create a new one to enjoy the best features of your Smart TV.

Before creating a new account, make sure your TV is connected to the network. For more about network settings, please refer to [First-Time Use > Connect to the Internet > Connect to a Wired \(Ethernet\) Network](#) or [Connect to a Wireless Network](#) in this manual.

1. After the network is connected, press  /  button on your remote control and select  **VIDAA Account** icon in the top navigation bar on the Home screen.
2. Select **Create an Account** on screen.
3. Enter your first name, last name, E-mail address and password. First Name and Last Name are optional.
4. Select **Create an Account**.

Voice Service Setup



Set up voice assistant to control your TV by your voice.

Note:

- Voice Service feature may not be applicable in some models/countries/regions.
- To use this function, End User License Agreement and corresponding Smart feature privacy policy/terms and conditions may be required to be agreed to.

Hands-Free Wake-up

Interacting with Alexa or VIDAA Voice by just using your voice, all hands-free.

Before using Hands-Free Wake-up, connect your TV to the network and sign into your VIDAA Account at  /  >  **VIDAA Account**. For more information about how to sign into the VIDAA Account, please refer to [Benefits of Smart TV > Using a VIDAA Account](#) in this manual.

Benefits of Smart TV

How to use Hands-Free Wake-up



After the Alexa or VIDAA Voice setup has been completed, enable the physical switch on the side of the remote control to receive voice, then say "Alexa" or "Hey VIDAA" to call up the voice assistant without the use of your hands.

Note:





- The Hands-Free Wake-up function may not be applicable in some models/countries/regions.
- If Hands-Free Wake-up is not used, please disable the physical switch to lengthen the battery life of the remote control.
- Built-in microphone in your remote control may not be available in some models.
- The setup steps may vary. Please refer to the specific product.
- This feature requires Alexa built-in service.

Alexa Setup



Interact with Alexa by pressing and holding the microphone button on your remote control. You can ask Alexa to control this TV.

Before setting up the Amazon Alexa Service, connect your TV to the network and sign into your VIDAA Account at  /  >  **VIDAA Account**. More information about how to sign into the VIDAA Account, please refer to [Benefits of Smart TV > Using a VIDAA Account](#) in this manual.

How to set up Alexa

1. Press  /  button to select  **Settings** icon, and select **System > Voice Service > Amazon Alexa**.
2. Select **Set voice assistant to Alexa** and **Set Up Alexa**. If you have selected Alexa in the Guide when you turn on the TV for the first time, it will directly guide you to the **Set Up Alexa** step.
3. Select Amazon Alexa supported voice language from the selection.
4. You are now at the step 'Sign into your Amazon account'. Scan the QR code with your mobile device or visit the website on your mobile device or computer and enter the on-screen code. The code will expire after 10 minutes. If you do not have an Amazon account, create a new one.
5. After you have linked the Amazon account, the TV screen will change to the next step. You can sign into your VIDAA account. If you have signed in before, this step will be skipped.
6. Now Alexa is set up and ready. You can enjoy interacting with Alexa using your voice by just pressing and holding the  button on your remote control. Ask Alexa after the tone.

Note:

- The Alexa function may not be applicable in some models/countries/regions.
- The setup steps above may vary. Please refer to the specific product.
- Shipment with voice remote control varies depending on TV models/countries/regions.
- You can use Alexa without signing into your account by skipping the sign in section. In this case, you can still use your voice to change the channel and control playback. Sign into your account in the settings menu at any time to enjoy more functions of Alexa.
- This feature requires Alexa built-in service. Otherwise, use external Alexa-enabled devices (e.g. Alexa App, Echo) to control your smart TV by using just your voice.
- Download and install the remote control app on your mobile device at  /  >  **Settings > Support > Mobile App Download**. Press the Microphone icon in the app to interact with Alexa on your TV.

Benefits of Smart TV

- You can select the language used by Alexa at / > **Settings** > **System** > **Voice Service** > **Amazon Alexa** > **Language**. This feature requires Alexa built-in service, which varies depending on TV models and countries/regions.

Related information

[Connect to a Wired \(Ethernet\) Network](#) on page 6

[Connect to a Wireless Network](#) on page 7

VIDAA Voice Setup

VIDAA Voice is a voice assistant to help you control the TV and search content, supporting several languages.

Before using VIDAA Voice, please check the following:

- Network connected
- Voice remote paired
- End User License Agreement and voice feature privacy policy/terms agreed

To access the Voice Service centre and set voice assistant to VIDAA Voice, you can choose one of following options:

- Just press button on your remote control.
- Press / button on your remote control and select **Voice** icon in the navigation bar.
- Press / button to select **Settings** icon and select **System** > **Voice Service**.

When VIDAA Voice is selected as your voice assistant, select the language of VIDAA Voice in the Voice Service centre. Then press and hold the button on your remote control to interact with VIDAA Voice.

Note:

- VIDAA Voice may not be applicable in some models/countries/regions.
- Shipment with remote control varies depending on TV models/countries/regions.
- For remote controls without the Microphone button, download and install the app on your mobile device at / > **Settings** > **Support** > **Mobile App Download**. Press the Microphone icon in the app to interact with your TV.

Related information

[Connect to a Wired \(Ethernet\) Network](#) on page 6

[Connect to a Wireless Network](#) on page 7

[Using the Mobile App](#) on page 34

Google Assistant

Setup Google Assistant and enjoy the Google Assistant service. You can ask for information, search for your favourite movies, control your TV and more, just by asking Google Assistant.

Before setting up Google Assistant, connect your TV to the network.

STEP 1: Set up Google Assistant on TV

1. Press / button on your remote control to select **Settings** icon, and select **System** > **Voice Service** > **Google Assistant**.

Benefits of Smart TV

2. Set voice assistant to Google Assistant and press  button to activate. If you have selected Google Assistant in the Guide when you turn on the TV for the first time, it will directly guide you to the activation step.
3. Then read on-screen terms of service and privacy policy, then select **I understand**.
4. Next, select **Allow** to enable information sharing.

STEP 2: Sign in to talk to your Assistant on this TV

Follow the setup instructions on-screen to set up Google Assistant. Scan the QR code with your phone's camera, or go to the website on screen, then enter the setup code on your TV.



Google Assistant is set up and ready. Control your smart TV using your voice by just pressing and holding the  button on your remote control.

Note:



- The Google Assistant function may not be applicable in some models/countries/regions.
- The setup steps above may vary. Please refer to the specific product.
- Shipment with voice remote control varies depending on TV models/countries/regions.
- If you do not choose to sign in, just press  button to continue without signing into your Google account. You can go to TV system settings later to sign into your Google account to enjoy personal queries by asking Google Assistant, like showing your photos, calendar and more via this device.

Google Smart Home Service Setup

For specific models and countries/regions, Google Smart Home Service function is available. Set up Google Smart Home Service to control your smart TV with Google Home devices or the App. You can change channels or inputs, adjust volume and more.

Before setting up the Google Smart Home Service, connect your TV to the network and sign into your VIDAA Account at  /  >  **VIDAA Account**. More information about how to sign into the VIDAA Account, please refer to [Benefits of Smart TV > Using a VIDAA Account](#) in this manual.

STEP 1: Set up Google Smart Home Service on TV

1. Press  /  button on your remote control to select  **Settings** icon and select **System > Voice Service > Google Smart Home Service**. Select **Set up now**.
2. Sign into your VIDAA account. If you have signed in before, this step will be skipped.
3. Give your TV a name.

STEP 2: Set up in Google Home app

Follow the setup instructions on-screen to set up the Google Smart Home Service.

1. Download and install the Google Home app on your mobile device, then open the app.
2. Find and select VIDAA Voice service in the app.
3. Follow the instructions in the app to link your VIDAA account signed in on your TV to your Google Account.

Google Smart Home Service is set up and ready. Control your smart TV by using your voice through the Google Home device or App.

Note:

- Google Smart Home Service may not be applicable in some models/countries/regions.

Benefits of Smart TV

- The setup steps above may vary. Please refer to the actual product.



Related information

[Connect to a Wired \(Ethernet\) Network](#) on page 6



[Connect to a Wireless Network](#) on page 7

Yandex Smart Home Service Setup

Yandex Alice voice assistant can obey certain commands to help you change the TV's configuration.

Before setting up Yandex Smart Home Service, connect your TV to the network and sign into your VIDAA Account at  /  >  **VIDAA Account**. More information about how to sign into the VIDAA Account, please refer to [Benefits of Smart TV > Using a VIDAA Account](#) in this manual.

STEP 1: Set up Yandex on TV

1. Press  /  button on your remote control to select  **Settings** icon, then select **System > Voice Service > Yandex**. Select **Set up now**.
2. Sign into your VIDAA account. If you have signed in before, this step will be skipped.
3. Give your TV a name.

STEP 2: Set up in Yandex App

Follow the instructions on the TV to enable Yandex Smart Home Service.

1. Download the Yandex app on your mobile device.
2. Open the app and sign into your Yandex account.
3. In the Yandex app, go to "Devices" > "Smart Home", click add device icon and select "VIDAA Voice".
4. Merge Account by signing in to your VIDAA Account.

Yandex Smart Home Service is set up and ready. Now you can control your Smart TV with Yandex Alice devices or the Yandex app to change channel, change inputs, adjust volume and more, just by asking Alice.

Note:

- The Yandex function may not be applicable in some models/countries/regions.
- The setup steps above may vary. Please refer to the specific product.



Related information

[Connect to a Wired \(Ethernet\) Network](#) on page 6

[Connect to a Wireless Network](#) on page 7

Voice Service Other Issues

If you want to turn on your TV with Alexa-enabled devices (e.g. Echo, Echo show) or Google Home devices (e.g. Google Home, Google Nest Hub), please:

- Turn on **Wake on LAN** and **Wake on Wireless Network** at  /  >  **Settings > Network**.
- Make sure your TV and Alexa-enabled devices/Google Home devices are connected to the same network environment.

Note:

- Only Alexa (Alexa skill is enabled) and Google Smart Home Service support turning on your TV with Alexa Echo or Google Home.

Benefits of Smart TV

☰ Related information



[Connect to a Wired \(Ethernet\) Network](#) on page 6

[Connect to a Wireless Network](#) on page 7

Content Sharing

Content Sharing allows you to view media content, like videos, music or photos saved in your Android/iOS/PC device on your TV screen.

Share Media Content from your Device

1. Connect your TV and Android/iOS/PC device to the same network.
2. Turn on Content Sharing at  /  >  **Settings > System > Mobile Device Connection > Content Sharing.**
3. Turn on the content sharing function in your Android/iOS/PC device.
4. Find the TV name in the search list of your device and select it. Wait for the connection progress to complete.
5. On your Android/iOS/PC device, choose the media content you want to share on your TV.

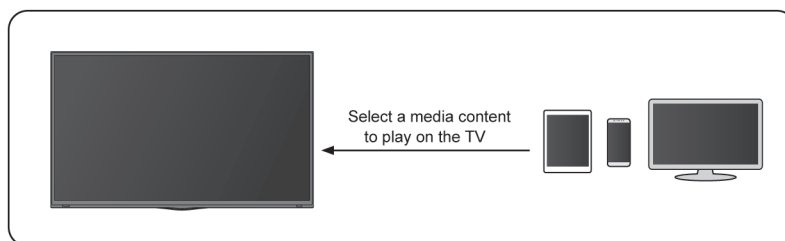









☰ Related information

[Connect to a Wired \(Ethernet\) Network](#) on page 6

[Connect to a Wireless Network](#) on page 7

Play Media Content from your Device on the TV

You can connect media content saved in your Android/iOS/PC device to your local network and play the content on your TV.

1. Connect your TV and Android/iOS/PC device to the same network.
2. Turn on Content Sharing at  /  >  **Settings > System > Mobile Device Connection > Content Sharing.**
3. Make sure your media content in your Android/iOS/PC device are visible through the local network.
4. On your TV, select a device with media content at  /  >  **Input**, or  /  > **More Apps > Media**. The media content list in your Android/iOS/PC device appears.
5. Select a media content item from the list to play.



Note:

- Some Android/iOS/PC devices may not support content sharing function. If your device does not support content sharing, you can download an app that supports the function to connect to your TV. For more information, please refer to [Benefits of Smart TV > Using the Mobile App](#) in this manual.
- Content may not be played depending on the file format.

Benefits of Smart TV

- Content may not be played smoothly, or the function may not work properly due to the network condition.

Using Apps



Press  /  button on your remote control and select **More Apps**.

Numerous factory-installed apps are available for you to choose for your entertainment preferences.

Install an App from App Store

Even though your TV has numerous factory-installed apps, there may be others that you would like to download.

To install an app:

1. Press  /  button on your remote control and select **More Apps > app store**.
2. Use the navigation buttons on your remote control to select the app that you want to install.
3. Select **Install**. The selected app is installed on the TV.

Note:







- To use this function, your TV must be connected to the Internet.
- Adding apps is free, but it might cost you money when using some apps.

Related information

[Connect to a Wired \(Ethernet\) Network](#) on page 6

[Connect to a Wireless Network](#) on page 7

Manage Apps

1. In **More Apps**, select the app you want to sort, then press and hold the  button to select **Sort**.
2. Press  /  /  /  button to move it.
3. Press  button to store position.

Note:



- Some Apps may not be moved.

Remove an App

You can only delete apps that you have installed to the TV. Factory-installed apps cannot be deleted.





1. In **More Apps**, select the app you want to remove, then press and hold the  button to select **Remove**.
2. Select **OK**. The selected app is deleted.

Using the Art App

Press  /  button on your remote control, and select **More Apps > VIDAA art**.



Numerous artworks created by global artists presented for you to browse or set as a screensaver.

- Browse artworks

When you select an artwork to browse in full screen mode, press  /  button to switch artworks and press  /  /  button to display detailed information of the artwork. You can communicate with the artist using your mobile device to scan the QR code on the TV screen.

Benefits of Smart TV

- Add artworks to your favourite list

Press  /  button on your remote control to add the selected artwork to your Favourite list.



- ART settings

Select  icon in ART to set up **Time until the screen saver starts automatically**, **Picture switching time**, **Backlight** and **Screen saver selection**.

Note:

- This feature may not be applicable in some models/countries/regions.

Enjoy the Internet

Press  /  button on your remote control, and select **More Apps > Browser**.

You can enter websites and browse information on the Internet.

Make sure your TV is connected to the network before accessing the internet via the Browser.

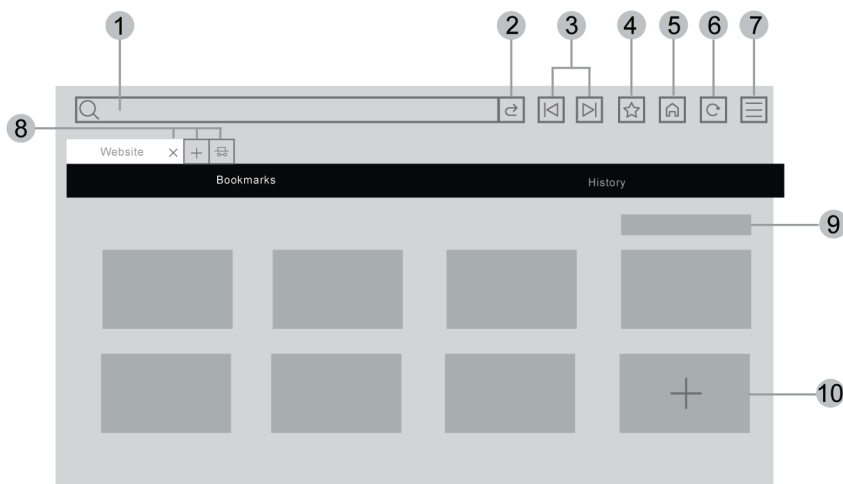

1. Enter website you want to visit
2. Visit/Search
3. Back/Forward: switch among webpages
4. Add the website you are viewing to Bookmarks
5. Back to the Homepage
6. Reload the website
7. Enter browser settings or add the website to Shortcuts on the Home screen.
8. Add/remove webpages, or add private webpages
9. Manage websites in Bookmarks
10. Add websites to Bookmarks

Note:

- The image is only for reference and may differ from the actual product.
- Some contents in the Browser may not be played properly.

Benefits of Smart TV

Related information



[Data Protection and Security](#) on page 33

[Connect to a Wired \(Ethernet\) Network](#) on page 6

[Connect to a Wireless Network](#) on page 7



Data Protection and Security

Clear Cache

Press  /  button on your remote control and select  **Settings** > **System** > **Application Settings** > **Clear Cache**.



Clear cache, user data and temporary files for browser and applications.

Delete Cookies

Press  /  button on your remote control and select  **Settings** > **System** > **Application Settings** > **Delete Cookies**.

Delete cookies for browser and applications.

Do Not Track



Press  /  button on your remote control and select  **Settings** > **System** > **Application Settings** > **Do Not Track**.

Set up tracking preference for websites and some applications.

Note:

- This function may not be applicable in some models/countries/regions.



Usage Mode Setup

Press  /  button on your remote control and select  **Settings** > **System** > **Advanced Settings** > **Usage Mode**.

Set the TV to use in Home or Store mode.



Home Mode

Select Home Mode for normal TV usage.





If you want to switch to Store Mode when the TV is in Home Mode, press  /  button to select  **Settings**, then select **System** > **Advanced Settings** > **Usage Mode** and choose **Store Mode**.

Store Mode

Select Store Mode to setup the TV in a retail setting. This mode enables E-Pos and other demo functions and is only intended for use in retail stores.

When Store Mode is selected, press  /  button on your remote control to enter store mode settings.

Benefits of Smart TV

If you want to switch to Home Mode when the TV is in Store Mode, press  /  button on your remote control to enter store mode settings and choose **Home Mode**. Alternatively, press  /  button to select  **Settings**, then select **System > Advanced Settings > Usage Mode** and choose **Home Mode**.

Note:







- Enabling Store Mode could increase energy consumption.
- How to exit Store Mode varies depending on models/countries/regions.

Using the Mobile App

Press  /  button on your remote control and select  **Settings > Support > Mobile App Download**.

Scan the Mobile App download QR code on screen to install the app on your mobile device. It is a convenient and easy way to control your TV. This app is available on both Android and iOS.

To connect to your TV after installing the mobile app:

1. Agree with end user license, disclaimer and privacy policies on the TV. If you are not sure whether you have agreed, check by pressing  /  button on your remote control and select  **Settings > Support > Disclaimer and Privacy > Terms & Conditions, Privacy Policy**.
2. Make sure your mobile device and TV are connected to the same network environment.
3. To use this function, switch on **Content Sharing** by pressing  /  button on your remote control and select  **Settings > System > Mobile Device Connection > Content Sharing**.
4. Open the mobile app and select the TV device you want to connect.

What you can do with the app:

- Turn the TV on or off
- Volume up or down
- Switch channels
- Input characters with your mobile's keyboard
- Share pictures, music, or videos from your mobile device to the TV

Related information

[Connect to a Wired \(Ethernet\) Network](#) on page 6

[Connect to a Wireless Network](#) on page 7

Connecting to External Devices



Remote & Accessories

Connect remote controls or other accessories, such as keyboard, mouse and gamepad, to interact with your Smart TV with ease.



Connect Remote Control

Connect a Bluetooth remote control

Pair the Bluetooth remote with the TV.



1. To pair the Bluetooth remote control to the TV after you power the TV on, press  /  button on your remote control, and select  **Settings** > **Network** > **Bluetooth**, and set **Bluetooth** to **On**.
2. Keep the remote control within 3 metres of the TV. Press any button (except power and mic button) to pair the remote control with the TV.

Note:



- In special cases, press and hold  /  button to pair.
- This function may not be applicable in some models/countries/regions.
- If an error occurred while trying to pair the remote control, it could have been caused by interference. Try to remove what is causing the interference and try pairing again.
- If an error occurred with the remote control while using sufficiently charged batteries, you can remove the batteries for 1~2 seconds then insert them once again. Now the remote control should work correctly.
- The remote control cannot be paired to the TV while the TV is in standby mode.

Use HDMI & CEC

Use the TV remote to control external devices that are connected to the TV by a HDMI cable. The external devices need to support HDMI & CEC function.

Press  /  button on your remote control and select  **Settings** > **System** > **HDMI & CEC**.



Connect an external device through HDMI & CEC function

Press  /  button on your remote control and select  **Settings** > **System** > **HDMI & CEC** > **CEC Control**.

Allow HDMI devices to control each other.

1. Set **CEC Control** to **On**.
2. Connect a HDMI & CEC compatible device to the TV.
3. Turn on the connected external device. The device will be connected to the TV automatically. After connection is completed, you can access the menu of the connected device on your TV screen using your TV remote and control the device.
4. When CEC control is enabled and HDMI & CEC compatible external devices are turned off, the TV will enter the standby mode. The function needs to be supported by the external device.



Enable device auto power off

Press  /  button on your remote control and select  **Settings** > **System** > **HDMI & CEC** > **Device Auto Power Off**.

Set to **On** to turn off HDMI & CEC compatible external devices when the TV is turned off.

Connecting to External Devices



Enable device auto power on

Press  /  button on your remote control and select  **Settings > System > HDMI & CEC > Device Auto Power On**.

Set to **On** to turn on HDMI & CEC compatible external devices when the TV is turned on.



This feature is applicable when TV input source is pre-set to the corresponding external device.

Enable TV auto power on

Press  /  button on your remote control and select  **Settings > System > HDMI & CEC > TV Auto Power On**.

Set to **On** to turn on the TV when HDMI & CEC compatible external devices are turned on.

HDMI format function

Press  /  button on your remote control and select  **Settings > System > HDMI & CEC > HDMI Format**.

Please select **Enhanced format** if your HDMI device supports 4K HDR. If it does not support 4K HDR, please select **Standard format**.

Note:

- HDMI cables must be used to connect HDMI & CEC compatible devices to your TV.
- The HDMI & CEC feature of the connected device must be turned on.
- If you connect a HDMI device that is not HDMI & CEC compatible, the HDMI & CEC control features will not work.
- Depending on the connected HDMI device, the HDMI & CEC control feature may not work.
- The HDMI & CEC feature supports One Touch Play, Routing Control, System Standby, Device OSD Name Transfer, Remote Control Pass Through, Give Device Power Status, System Audio Control.

Related information

[HDMI & CEC Issues](#) on page 79



Control the TV with a Keyboard, Mouse or Gamepad

Connect a keyboard, mouse or gamepad to control your TV with ease.

Connect a USB keyboard, mouse or gamepad

Plug the keyboard, mouse or gamepad cable into the USB port of your TV.

Connect a Bluetooth keyboard, mouse or gamepad

Locate the Bluetooth device by pressing  /  button on your remote control and select  **Settings > Network > Bluetooth > Equipment Management**.

Note:

- Keyboard, mouse, or gamepad connected via USB or Bluetooth technology may not be usable with some Apps.
- Bluetooth function may not be supported depending on the models/countries/regions.
- For more information about how to connect a Bluetooth device, refer to the Bluetooth device's user manual.



Connecting to External Devices

☰ Related information

[Connect a Bluetooth Device](#) on page 37

Connecting Bluetooth Devices



You can connect to devices using Bluetooth technology.

Press  /  button on your remote control and select  **Settings > Network > Bluetooth**.

Note:

- Bluetooth function may not be applicable in some models/countries/regions.

Turn on Bluetooth Feature on your TV







Press  /  button on your remote control and select  **Settings > Network > Bluetooth** and set **Bluetooth** to **On**.

Note:

- This function may not be applicable in some models/countries/regions.

Connect a Bluetooth Device

To pair a Bluetooth device, such as Bluetooth headphones, speakers, keyboards, mouse or even mobile devices:

1. Press  /  button on your remote control, select  **Settings > Network > Bluetooth** and set **Bluetooth** to **On**.
2. Before pairing your Bluetooth device, make sure it is in the pairing mode and placed within pairing range. To put your Bluetooth device in pairing mode, refer to the user manual of your device.
3. Find the Bluetooth device name by pressing  /  button on your remote control and selecting  **Settings > Network > Bluetooth > Equipment Management**, once it is located select it. The device will be automatically connected to the TV.

Note:



- Only one Bluetooth speaker or Bluetooth headphone can be connected to the TV. If a new Bluetooth speaker or headphone connects to the TV, the existing one will be disconnected automatically.
- Some compatibility issues may occur depending on the Bluetooth device support.
- Bluetooth keyboards may not be functional with some applications.
- The TV and Bluetooth devices may become disconnected if the distance between them is too long.
- This function may not be applicable in some models/countries/regions.

☰ Related information

[Headphone Settings Setup](#) on page 53

Listen to the Audio through Bluetooth Devices

Pair the Bluetooth audio device using the TV's Bluetooth setup process. Refer to the user manual for your audio device, such as Bluetooth speaker or sound bar, for detailed connection and setup.



After the Bluetooth connection is completed, press  /  button on your remote control, and select  **Settings > Sound > Speakers > Audio Output**, then select **Bluetooth Speaker** option to listen to the audio through Bluetooth devices.

Connecting to External Devices

Note:

- Compatibility issues may occur depending on the Bluetooth device.
- The TV and Bluetooth devices may become disconnected if the distance between them is too long.
- This function may not be applicable in some models/countries/regions.



Listen to your Mobile Device Audio through the TV

Press  /  button on your remote control and select  **Settings** > **Network** > **Bluetooth** > **TV Bluetooth Speaker**.

Mobile devices are connected to the TV via Bluetooth and audio is played via the TV speaker.

When your mobile device is connected to the TV via Bluetooth, you can play your mobile device music through the TV built-in speakers.

Go to your mobile settings to enable Bluetooth and choose the TV to connect.

To use this function, make sure to select **TV Speaker** at  /  >  **Settings** > **Sound** > **Speakers** > **Audio Output**.

Note:

- This function may not be applicable in some models/countries/regions.





Related information

[Select Speakers](#) on page 52

Connecting a Set Top Box

Before connecting a Set Top Box to the TV, make sure the TV and Set Top Box are switched off.





Most STB's can be connected via HDMI, HDMI offers the best picture and sound quality. For more information about how to connect a Set Top Box to your TV, please refer to [Connecting to External Devices > Connecting Audio Visual \(AV\) Devices](#) in this manual.

When the connection is completed, turn on your TV and Set Top Box, switch to the input source by pressing the  /  button, then select the  **Input** icon on Home screen or press the **INPUT** /  button to change to the port that you connected your Set Top Box to.

Connecting a Blu-ray or DVD Player

Before connecting a Blu-ray or DVD player to the TV, make sure the TV and Blu-ray or DVD player are switched off.

It is recommended to connect your devices with a HDMI cable (if HDMI port is available) to enjoy better picture and sound quality. More information about how to connect a Blu-ray or DVD player to your TV, please refer to [Connecting to External Devices > Connecting Audio Visual \(AV\) Devices](#) in this manual.

When the connection is completed, turn on your TV and Blu-ray or DVD player, switch to the input source by pressing the  /  button, then select the  **Input** icon on Home screen or press the **INPUT** /  button to change to the port that you connected your Blu-ray or DVD player to.



Sharing your Smart Phone/Computer Screen on the TV

Before using the feature, please set your TV to the wireless network connection.

Connecting to External Devices

Press **INPUT** /  button on your remote control and select **Screen Sharing**.

1. Turn on the casting function of your Android/Windows 10/computer device. The setting icon may vary depending on the device. The feature may be called "Wireless display", "Smartview", "Wireless projection", etc.
2. Find the TV name in the search list of your device and select it. Wait for the connection progress to complete and the content on your device will be displayed on the TV.

Press  /  button on your remote control, select  **Setting > System > Mobile Device Connection > Screen Sharing** and switch it to on. Then, you can share your device's screen directly without opening the Screen Sharing App on your TV.

Note:

- Some devices may not support casting.

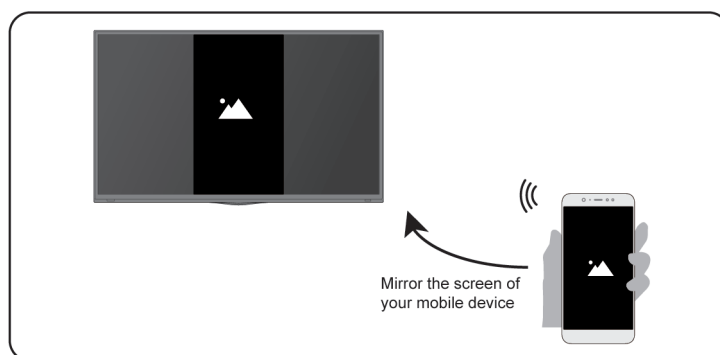

Related information

[Connect to a Wireless Network](#) on page 7

Using AirPlay and HomeKit

Note:

- This function may not be applicable in some models/countries/regions.

Using Airplay



Use AirPlay to wirelessly share audio and video content from your iPhone, iPad, or Mac to your TV. Stream music and videos, share your photos, or mirror exactly what's on your device's screen.

AirPlay is a source in Inputs. Press the **INPUT** /  button on your remote control to select the AirPlay, then select AirPlay and HomeKit Settings. You can also find AirPlay and HomeKit settings in system settings on your TV.

How to use AirPlay:

1. Make sure your Apple device is connected to the same network as your TV.

Connecting to External Devices

2. Locate the AirPlay icon on supported media apps, or the Screen Mirroring icon in Control Center on your Apple device. Depending on the content, these steps may vary:
 - To mirror your device's screen, open Control Center and tap Screen Mirroring .
 - To stream audio from supported music or podcast apps, tap AirPlay audio .
 - To stream video from supported apps, tap AirPlay video .
3. Select your TV from the list to begin using AirPlay.

Note:

- An AirPlay-enabled TV.
- The TV and Apple devices are connected to the same network.
- The icon is only for reference. In some apps, you may have to tap another icon first.
- If an AirPlay passcode appears on your TV screen, enter the passcode on your Apple device to continue.

Using HomeKit

Use HomeKit to easily and securely control your TV using your Apple devices.

1. To set up HomeKit, open AirPlay and HomeKit settings on the TV. Locate the HomeKit section and select 'Set Up'.
2. The HomeKit setup screen will display a pairing QR code on the TV. Use your iPhone or iPad to scan the QR code, then follow the on-screen directions to complete HomeKit setup.

Note:

- Available operations vary depending on the version of the app and software.

Connecting USB Devices

Connect USB devices, such as hard drives and USB memory sticks for browsing photos or listening to music.

Read before connecting USB devices

USB disk sizes 4GB, 8GB, 16GB, 32GB, 64GB, 128GB and other common market sizes are supported. Up to 8TB hard drives are supported.

Supported formats: NTFS, FAT32.

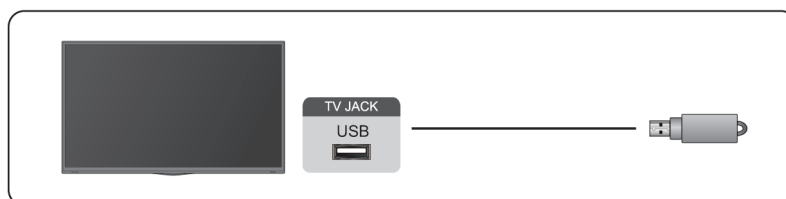

Select the content you want to play or view. For more information, please refer to [Entertainment > Media](#) in this manual.

Use the USB storage device function

The USB storage device function can be used to record and view digital broadcast programmes.

Connecting to External Devices

Read the precautions below before recording or viewing programmes by using the USB storage device function.

Note:



- Be sure to select the correct country/region for use.
- Use of the recording function may not be applicable depending on the selected country/region. Use with incorrect settings may violate certain laws or other regulations, and may result in criminal punishment. In such cases, our CORPORATION and the Group shall bear no responsibility whatsoever.
- Recorded programmes saved in the USB storage device can only be viewed on this TV. They cannot be viewed when connected to another TV (including the same model of TV), a PC, or other devices.
- You cannot watch one channel while recording another.
- If the recording time to the USB storage device is too short, no data may be saved.
- You cannot record video input signals in the USB device.
- Not all types of broadcast may be recordable.
- After programming the TV to record digital broadcasting, do not disconnect the power plug before recording starts.
- If video or audio recording fail due to malfunction of the TV or poor reception, no compensation shall be paid.
- Certain digital cameras may not be compatible with the TV.

Connecting Headphones

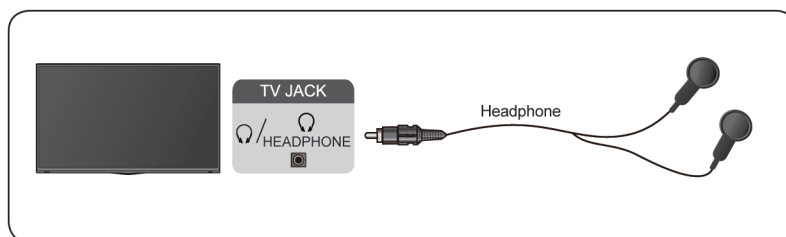
You can connect a pair of headphones (not provided) to the HEADPHONE port on your TV. While the headphone is connected, the sound from the built-in speakers will be disabled.



Note:

- Headphone port may not be available in some models.
- Headphones with microphones are not supported.
- If **Headphone with Speakers** is selected at  /  >  **Settings** > **Sound** > **Headphone** > **Headphone Mode**, the headphone and the TV will have sound output at the same time.

Related information

[Headphone Settings Setup](#) on page 53

Connecting Audio Visual (AV) Devices

Connect with a composite video cable

To connect an AV device with a composite video cable (not provided), see the illustration below.

Connecting to External Devices

When the connection is completed, press **INPUT** /  button on your remote control and select **AV** as the input source.

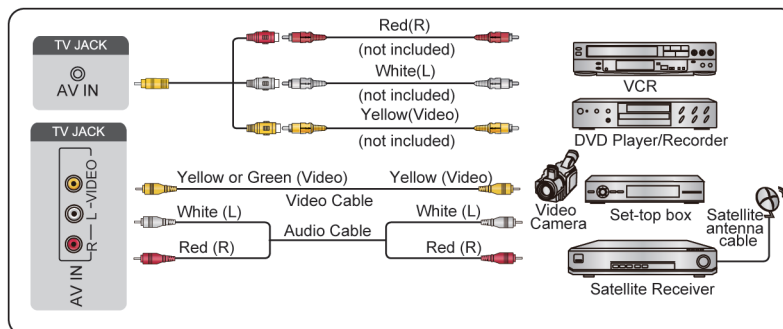

Note:

- AV IN port(s) may vary depending on model type.
- AV IN port(s) may not be available in some models. Please use other port(s) to connect AV devices.
- For some models, RCA Jack to AV cable may not be supplied.

Connect with a HDMI cable

To connect an AV device with a HDMI cable (not provided), see the illustration below.

When the connection is completed, press **INPUT** /  button on your remote control and select the corresponding HDMI input.

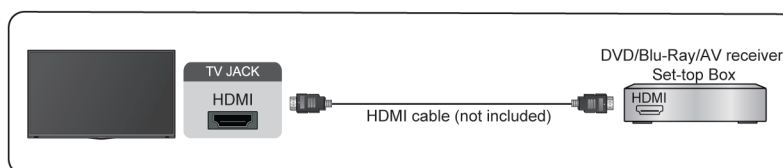

Note:

- Please refer to the User Manual of your device for step-by-step instructions.
- Some devices, such as DVD players, require the HDMI signal to be set to the correct format in the device settings. Please consult your device user manual for instructions.
- If there is no sound from your TV, configure the device audio settings.



Related information

[Use HDMI & CEC](#) on page 35

Connecting Speakers or Other Audio Receivers

To connect speakers or other audio receivers with an audio cable (not provided), see the illustration below.

Ensure the audio connected devices are switched on before switching on the TV.



When the connection is completed, press  /  button on your remote control, select  **Settings > Sound > Speakers > Audio Output** and select the **SPDIF Only** option.

Connecting to External Devices

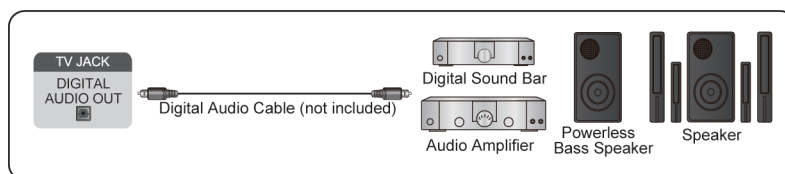
When a digital audio system is connected to the DIGITAL AUDIO OUT port, decrease the TV volume and use your digital audio system to control the volume.



Note:

- If you prefer to use Audio Return Channel (ARC) or enhanced Audio Return Channel (eARC), please refer to [Connecting to External Devices > Connecting a Digital Audio System with ARC/eARC](#) in this manual.
- You can connect the DIGITAL AUDIO OUT port on the back of the TV to the optical port on the amplifier. Then press  /  button on your remote control and select  **Settings** > **Sound** > **Speakers** > **Digital Audio Output** to choose **Dolby Audio - Dolby Digital** to receive the Dolby Digital audio.

Related information

[Select Speakers](#) on page 52





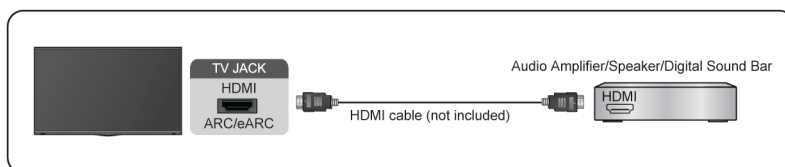

Connecting a Digital Audio System with ARC/eARC

If you would like to use the Audio Return Channel (ARC) or enhanced Audio Return Channel (eARC) feature to send sound from the TV by a HDMI cable to a digital sound system, you can connect it to the HDMI (ARC/eARC) port of your TV.

By using this feature, you can also control the sound system with your TV remote instead of using the remote controls from the connected devices.



After the connection:

1. Power on the sound system.
2. Press  /  button and select  **Settings** icon on the Home screen.
3. Select **Sound** > **Speakers** > **Audio Output**, and choose **ARC** option. If the device supports eARC function, press  /  button and select  **Settings** icon on the Home screen, then select **Sound** > **Speakers** > **eARC** to set **eARC** to **On**.

Note:

- Audio receiver must support ARC/eARC function.
- If the device has an Input Selector feature, then make sure to change it to TV.
- When this port is used for ARC/eARC function, it can be used as signal input when a DVD is connected to an amplifier and the amplifier is connected to the TV at the same time. Some amplifiers may not support series connection.

Connecting to External Devices

- 5.1 CH (channel) audio is available when the TV is connected to an external device that supports 5.1 channel surround sound. You can press  /  button and select  **Settings** icon on the Home screen, and select **Sound > Speakers > Digital Audio Output** to choose **Dolby Audio - Dolby Digital Plus** to receive the 5.1 channel audio.

Related information

[Select Speakers](#) on page 52

Connecting a PC

You can connect a PC to the TV with a HDMI cable to use your TV as a PC monitor.

After connecting the PC, press **INPUT** /  button and select the connected PC as the input source.

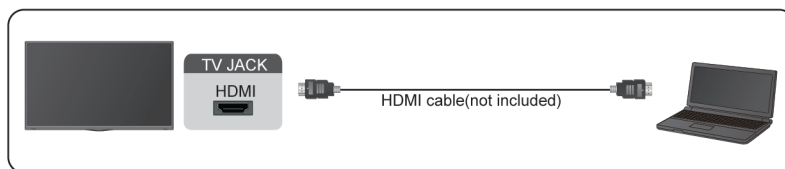

Note:



- For better image quality, set the PC's resolution to a format which is supported by the TV.
- If there is no sound from your TV, change the PC's audio settings.
- If you want to connect your PC and TV wirelessly, please refer to [Benefits of Smart TV > Content Sharing](#) or [Connecting to External Devices > Sharing your Smart Phone/Computer Screen on the TV](#) in this manual.

Settings Overview

Picture

Adjust picture mode, picture size and other advanced picture settings.

Choose a Picture Mode

Press  /  button on your remote control and select  **Settings > Picture > Picture Mode**.

Select a pre-set picture mode to best suit the content you are viewing.

Note:

- Options may differ depending on your model/country/region and the content you are watching. Please refer to the specific product.

When you use a normal signal

- **Standard**

Use Standard mode for watching normal content, such as News, Drama or Documentaries.

- **Cinema Day**

Use Cinema Day for watching movies in a bright environment.

- **Cinema Night**

Use Cinema Night for watching movies in a dark environment.



- **Dynamic**

Use Dynamic mode for content that requires vivid picture quality.

- **Sports**

Optimised picture for watching sports.



- **FILMMAKER**

Press  /  button on your remote control, select  **Settings > Picture > Filmmaker Mode Auto Detect** and turn it on. When filmmaker signal is detected, picture mode will turn to **FILMMAKER** automatically.

This function is only applicable in the HDMI input source.

Low Blue Light for TUV Certification

Low Blue Light menu on your TV is designed to reduce the level of blue light to protect your eyes.

Press  /  button on your remote control, select  **Settings > Picture > Picture Mode Settings > Expert Settings > Low Blue Light** and select **On**.

To reduce eye strain and protect eyes when you watch TV for a period of time, you are recommended to:

- Take regular and frequent breaks, avoid watching TV for periods of more than one hour. Watching TV for long periods of time may cause eye fatigue.
- Look away from the TV screen and focus on distant objects during viewing breaks for at least 10 minutes.
- Relax yourself during viewing breaks by doing eye exercises or outdoor activities.
- The best recommended viewing distance is 3 times the vertical height of the TV screen.

Regular breaks and exercises are extremely helpful in relieving eye strain and fatigue.

Note:

Settings Overview

- This feature may not be applicable in some models/countries/regions. Low blue light certification may vary by model.



When you use a HDR signal

HDR (high dynamic range) can improve the viewing experience with higher contrast and vivid colours. Bright whites look brighter and dark blacks look darker. TV can display a wide range of colours.

When you use a Dolby Vision signal

Inspired by cinema technology, Dolby Vision is the format that allows your TV to deliver a full range of colours, high dynamic range images, brighter whites and dark blacks using scene-by-scene calibration.

Change the Aspect Ratio

Press  /  button on your remote control and select  **Settings > Picture > Aspect Ratio**.

Adjust the Aspect Ratio to stretch or zoom the picture.

- **Auto**

Automatically switch Aspect Ratio between 16:9 and 4:3 based on the signal information.

- **16:9**

Best suited for 16:9 Widescreen content. This will also stretch 4:3 content to Widescreen.

- **4:3**

Best suited for 4:3 content.

- **21:9**

Best suited for 21:9 content, generally used in game scenarios.

- **Movie Zoom**

Fill the entire screen by zooming in to remove horizontal black bars from the top and bottom of the picture.



- **Dot to Dot**

Displays the native signal without any scaling.

Note:

- The options above may not be applicable in some input sources.
- Using special functions to change the size of the displayed image (e.g. changing the height/width ratio) for the purpose of public display or commercial gain, may infringe on copyright laws.
- If the aspect ratio of the selected format is different from the TV transmission or video content, it can distort the picture.
- When connecting a PC to the TV via HDMI input, fast moving images may become distorted.

Smart Scene

Press  /  button on your remote control and select  **Settings > Picture > Smart Scene**.

Smart Scene will enable your TV to continually recognise the scene and enhance the picture quality on all input sources.

Note:

- Some specific applications have explicit constraints meaning content recognition is not allowed.

Settings Overview

Advanced Picture Settings Setup

Press  /  button on your remote control and select  **Settings > Picture > Picture Mode Settings**.

Adjust display settings for each Picture Mode. You can personalise the picture quality by adjusting the following settings. Options may not be applicable depending on your model/country/region and the picture mode you selected.

- **Apply Picture Settings**

Apply current picture mode settings to all the input sources or just the current source.

- **Backlight**

Set the overall brightness of the screen.

Note:

- The function name may vary depending on the model type.

The following option may differ depending on model type, please refer to the actual product.

Dynamic Backlight Control

Enhance the contrast ratio between light and dark areas of the picture.

This function may not be applicable in some models/countries/regions.

Backlight

Adjust how bright you want images to appear, lower settings create darker images.

This function may not be applicable in some models/countries/regions.

Automatic Light Sensor

TV will automatically adjust the picture settings according to the amount of ambient light in the room.

This function may not be applicable in some models/countries/regions.

Light Sensor Shift

This feature is adjustable only when Automatic Light Sensor is turned on. If the picture is too bright, decrease the value. If the picture is too dark, increase the value.

This function may not be applicable in some models/countries/regions.

Local Dimming (or **Dynamic Range maximum brightness** for some models)

TV will automatically adjust the backlight in specific areas of the screen according to the contrast changes in the image.

This function may not be applicable in some models/countries/regions.

- **Brightness**

Adjust the Brightness level to generate lighter or darker images.

- **Contrast**

Adjust the Contrast level to increase or decrease how bright images appear.

- **Colour Saturation**

Adjust the colour intensity of the picture for a more vibrant image.

- **Sharpness**

Adjust how sharp or soft the edges of images appear.

Settings Overview

- **Adaptive Contrast**

Automatically adjust dark areas and light areas of the image to see more detail.

- **Ultra Smooth Motion**

Reduce the afterimage effect when viewing fast-moving objects.

This function may not be applicable in some models/countries/regions.

- **Clear Motion**

Reduce judder and blur from video content.

This function may not be applicable in some models/countries/regions.

- **Noise Reduction**

Improve the picture quality by reducing noise.

- **MPEG Noise Reduction**

Reduce MPEG block noise to provide clearer edge transitions.

- **Colour Temperature**

Adjust how warm (red) or cool (blue) the white areas of an image appears.

- **Expert Settings**

Adjust advanced picture settings based on your viewing preference.

- **Overscan**

Change the video size setting to crop the edges of the displayed image.

This function may not be applicable in some models/countries/regions.



- **Reset Current Mode**

Restore all the picture settings in the current picture mode to the factory default values.

Related information

[Picture Issues](#) on page 76

Expert Settings Setup

Press  /  button on your remote control and select  **Settings > Picture > Picture Mode Settings > Expert Settings**.

Adjust the colour space and Gamma to best suit the content you are viewing. Options may not be applicable depending on your model/country/region and the picture mode you selected.

- **Colour Gamut**

Change the range of colours the TV displays.

This function may not be applicable in some models/countries/regions.

- **Colour Tuner**

Adjust the Hue, Saturation and Brightness of colour settings.

- **White Balance**

Adjust the intensity of red, green and blue to view the true colour of all images in the picture.

- **Black Level**

Adjust the HDMI Black Level to enhance current content.

Settings Overview

- **Gamma Adjustment**

Adjust the Gamma to alter how the TV will respond to grayscale content. In low ambient light choose a higher number, in brighter ambient light select a lower number. The default setting of 2.2 is recommended for most ambient light conditions.

This function may not be applicable in some models/countries/regions.

- **Gamma Calibration**

Adjust selected Gamma curve.

This function may not be applicable in some models/countries/regions.

- **Viewing Angle**

Provide a better viewing experience when watching TV from anywhere in the room.

This function is only available in models supporting the Viewing Angle Control feature.

- **RGB Only Mode**

RGB filter for adjustment and control of colour space and colour saturation.

- **Low Blue Light**

Eye care: reduce the emission of blue light.

This function may not be applicable in some models/countries/regions.

 **Related information**

[Picture Issues](#) on page 76

OLED Related Settings

Panel Refresh



Perform the panel refresh function to reduce image retention effects.

Due to the optical characteristics of OLED displays, image retention may occur after the TV has been used for an extended period of time. **Panel Refresh** is recommended to correct picture quality issues and prevent image retention.

Do not remove the power plug from the socket when you want to turn off the TV. Please press the power button on the remote to turn the TV off and **Panel Refresh** will be operated automatically when the TV is in standby mode.

The power indicator light will blink when **Panel Refresh** is in progress. The whole progress will take about an hour, during the process, the screen will be turned off, once completed the TV will go to standby mode.

You could also choose to manually start **Panel Refresh**.

To manually start **Panel Refresh**, press  /  button on your remote control and select  **Settings** > **Picture** > **Panel Refresh**.

Flashing light indicates **Panel Refresh** in progress.

Note:

- This function is only available for OLED models.

Sound

Adjust sound mode and other advanced sound settings.

Settings Overview

Choose a Sound Mode

Press  /  button on your remote control and select  **Settings > Sound > Sound Mode**.

Select a pre-set sound mode to suit the content you are listening to.

- **Standard**

In Standard mode, the TV delivers a flat frequency response, which preserves the natural characteristics of the original sound.

- **Theatre**

Theatre mode increases the surround sound effect and provides a more prominent bass response.

- **Music**

In Music mode, low and high frequencies are emphasised to enhance musical instrument reproduction.

- **Speech**

In Speech mode, low and high frequencies are attenuated to improve the reproduction and clarity of the human voice.



- **Late Night**

In Late Night mode, the TV will improve the reproduction and clarity of the human voice with a low volume level.

- **Sports**

Optimised sound for watching Sports events.

Dolby Atmos



Press  /  button on your remote control and select  **Settings > Sound > Dolby Atmos**.

Set **Dolby Atmos** to **On** to enhance the richness of sound allowing a more immersive listening experience.

Note:

- This function may not be applicable in some models/countries/regions.

Audio Enhancement

Press  /  button on your remote control and select  **Settings > Sound > Audio Enhancement**.

Set **Audio Enhancement** to enjoy the audio performance of Dolby Atmos, DTS Virtual X or Hi-Res. Enable or disable according to your own preference.

Note:

- This function may not be applicable in some models/countries/regions. Selections may vary depending on models.
- When Hi-Res is selected, some options in Sound settings may not be available for setup.

Sound Mode Settings Setup

Press  /  button on your remote control and select  **Settings > Sound > Sound Mode Settings**.

Adjust the audio settings of the TV. You can personalise the sound quality by adjusting the following settings.

- **Apply Audio Settings**

Adjust current sound mode to apply to all sources or just the current source.

Settings Overview

- **Total Sonics**

Optimise the overall sound quality by increasing bass and widening the sound field to provide a clear, natural dialogue.

This function may not be applicable in some models/countries/regions.

- **Total Volume**

Maintain a consistent loudness level for a wide dynamic range of programmes, loud commercials and channel or input changes.

This function may not be applicable in some models/countries/regions.

- **Total Surround**

Provide surround sound experience with psycho-acoustic processing to place sounds at the side, behind and above the viewer. For best results use with Total Sonics.

This function may not be applicable in some models/countries/regions.

- **Bass Boost**

Bass Boost uses DTS TruBass™ to enhance the perception of bass frequencies to provide deep, rich bass response from the TV's internal speakers.

This function may not be applicable in some models/countries/regions.

- **Surround Sound**

Surround sound uses DTS TruSurround™ to deliver an immersive surround sound experience from the TV's internal speakers.

This function may not be applicable in some models/countries/regions.

- **Dialog Clarity**

Dialog Clarity uses DTS Dialog Clarity™ to boost the frequency range of the human voice so dialogue is clearly understood and heard above audio or surround effects.

This function may not be applicable in some models/countries/regions.

- **TruVolume**

Automatic control over large volume changes while watching TV programmes or films, providing a more comfortable and consistent volume.

This function may not be applicable in some models/countries/regions.

- **Waves**

Based on the psychoacoustic low-frequency extension technology. Waves effectively extend bass response beyond the physical capabilities of the system, presenting a natural, vigorous and strong bass effect.

This function may not be applicable in some models/countries/regions.

- **Top Channel Gain**

Experience the rich high-pitched response with the TV's top speaker.

This function may not be applicable in some models/countries/regions.

- **Center Channel Gain**



Experience the rich human voice response with the TV's center speaker.

This function may not be applicable in some models/countries/regions.

Settings Overview

- **Equalizer**

Boost the volume at different frequencies.

This function is only applicable when **TV Speaker** is selected at  /  >  **Settings > Sound > Speakers > Audio Output**.

- **Bass Boost Gain**

Hear and feel rich bass response with the TV's subwoofer speaker.

This function may not be applicable in some models/countries/regions.

- **Wall Mount Setup**

Automatically optimise the sound based on the position of the TV.

This function may not be applicable in some models/countries/regions.

- **Auto Volume Control**

Activate to prevent the volume from changing when switching TV channels.

This function may not be applicable in some models/countries/regions.

- **Reset Current Mode**

Restore all of the audio settings in the current audio mode to the factory default values.



Note:

- Some models may not support decoding of DTS CD bitstreams. Playback of this format may produce undesirable noise.

 **Related information**

[Sound Issues](#) on page 77

Select Speakers

Press  /  button on your remote control and select  **Settings > Sound > Speakers**.

Adjust the settings of speakers.

Audio Output

Select the speakers which you want to use.

Digital Audio Output

Select the digital audio output format that best suits the audio device type.

- **Auto**: the audio device automatically outputs in a supported format.
- **Pass Through**: the audio device outputs without any processing.
- **PCM**: the audio device outputs PCM (pulse code modulation) format.
- **Dolby Audio - Dolby Digital**: the audio device outputs Dolby Digital audio when connected to the TV via the optical port.
- **Dolby Audio - Dolby Digital Plus**: the audio device outputs Dolby Digital Plus audio when connected to the TV via the HDMI (ARC/eARC) port.

Note:

- This function is only applicable when  /  >  **Settings > Sound > Speakers > Audio Output** is set to **ARC** or **SPDIF Only**.

Settings Overview

- When external audio devices are connected to the TV via optical, **PCM** and **Dolby Audio - Dolby Digital** are recommended.

Digital Audio Delay

Adjust the digital audio output delay time to sync audio from an external speaker with the images on the TV.

Note:

- This function is only applicable when  /  >  **Settings** > **Sound** > **Speakers** > **Audio Output** is set to **ARC** or **SPDIF Only**.

Lip Sync

Synchronise the video and audio.

Note:

- This function may not be applicable in some Audio Output modes.



Balance

Adjust the left and right speaker level to optimise audio for a specific location.

Note:

- This function may not be applicable in some Audio Output modes.

eARC

Connect an audio device that supports eARC via HDMI (eARC) and set **eARC** to **On** to enjoy higher sound quality. This feature is available to set when  /  >  **Settings** > **Sound** > **Speakers** > **Audio Output** is set to **ARC**.

Note:



- This function may not be applicable in some models/countries/regions.

Related information

[Connecting Speakers or Other Audio Receivers](#) on page 42

[Connecting a Digital Audio System with ARC/eARC](#) on page 43

Headphone Settings Setup

Press  /  button on your remote control and select  **Settings** > **Sound** > **Headphone**.

Set the sound output mode through headphones.

After connecting your wired or Bluetooth headphone, or other external audio amplifiers, you can set up your TV to your preference.

Note:

- This function may not be applicable in some models/countries/regions.

Headphone Mode

Change Headphone audio settings.

Headphone Only, the TV speakers will be muted when the headphones are being used. Any other connected audio devices will also be muted when headphones are in use.

Settings Overview

Headphone with Speakers, the TV speakers, headphones and other connected audio devices will have audio output.

Audio Out with Speakers, the TV speakers and headphones will have audio output simultaneously, and the volume can be adjusted simultaneously.

Note:

- When you set built-in speakers and earphones to have audio output at the same time, the sound effect of the speakers may change.

Headphone Volume

Independently adjust the volume of the Headphones.

In **Headphone Only** mode, you can adjust the volume by the remote or in Headphone Volume menu on screen.

In **Headphone with Speakers** mode, the TV speaker volume can be adjusted by the remote. The volume of headphone can be adjusted in Headphone Volume menu on screen.

Related information



[Connect a Bluetooth Device](#) on page 37



[Connecting Headphones](#) on page 41

SoundBar Settings

When a soundbar device is connected to the TV, you can change the **Sound Bar Settings** via the Settings menu for best device audio quality.

When an ARC device is connected to the TV, the sound output is automatically switched to ARC. If the user switches to other sound output channels, the soundbar menu cannot be adjusted but the sound menu of TV can be adjusted.

Press  /  button on your remote control and select  **Settings** > **Sound** > **Sound Bar Settings**.

When you connect a soundbar with a HDMI cable, you should Set **CEC Control** to **On** by pressing  /  button on your remote control, then select  **Settings** > **System** > **HDMI & CEC** > **CEC Control**.

- **EQ Modes**

You can select **Music**, **Movie**, **News**, **Sport**, **Night**.

- **Surround Modes**

You can set to **On** to turn on the Surround Modes.

- **Bass Level/Treble Level/Dimmer Level**

You can adjust **Bass Level/Treble Level/Dimmer Level**

- **Reset**

Reset current Sound Bar Settings to factory mode.

Note:

- This function is only applicable for the specific soundbar types.

Network

You can get access to the Internet through your TV.



Settings Overview

Check the Internet Connection Status

Press  /  button on your remote control and select  **Settings > Network > Internet Connection**.



Test the current network connection status and view the current network information.

Connection Test

Press  /  button on your remote control and select  **Settings > Network > Internet Connection > Connection Test**.

Start a network connection test.

Network Information

Press  /  button on your remote control and select  **Settings > Network > Internet Connection > Network Information**.

You can select IPv4 or IPv6 in **IP Version** to view more detailed information about your network connection.

Related information



[My TV cannot connect to the network.](#) on page 70

[Connect to a Wired \(Ethernet\) Network](#) on page 6

[Connect to a Wireless Network](#) on page 7

Turn on the TV through the Internet

Wake on Cast



Press  /  button on your remote control and select  **Settings > Network > Wake on Cast**.

You can enable or disable Wake on Cast function which is able to turn on the TV by screen casting through mobile devices.

Note:

- This function may not be applicable in some models/countries/regions.
- Enabling this function may result in higher energy consumption.

Wake on LAN



Press  /  button on your remote control and select  **Settings > Network > Wake on LAN**.

With a wired Ethernet connection and enabling **Wake on LAN**, you can switch on the TV from standby and push content to be viewed on the TV with a mobile device App supporting the screencast function.

Note:

- To use this function, make sure your TV and mobile device are connected to the same network environment.
- Enabling this function may result in higher energy consumption.
- This function may not be applicable in some models/countries/regions.

Wake on wireless network

Press  /  button on your remote control and select  **Settings > Network > Wake on Wireless Network**.

Settings Overview

With a wireless network connection and enabling **Wake on Wireless Network**, you can switch on the TV from standby and push content to be viewed on the TV with a mobile device App supporting the screencast function.

Note:

- To use this function, make sure your TV and mobile device are connected to the same network environment.
- Enabling this function may result in higher energy consumption.
- This function may not be applicable in some models/countries/regions.

Related information

[Connect to a Wired \(Ethernet\) Network](#) on page 6

[Connect to a Wireless Network](#) on page 7



General

You can set up system settings.

Note:

- The menus displayed vary depending on models/countries/regions.

Set Time

Press  /  button on your remote control and select  **Settings > System > Time**.

Set the current time based on your location.

- **Time Format**

Set the time display to be 12 or 24-hour format.

- **Date/Time**

Set the Date and Time. You can set the date and time to automatically sync with Internet/broadcast or manually setup by yourself.

This function may not be applicable in some models/countries/regions.

- **Time Zone**

Select your time zone.



This function may not be applicable in some models/countries/regions.

- **Daylight Saving**

Select whether to apply Daylight Saving Time to the TV.

This function may not be applicable in some models/countries/regions.

Use Timer

Press  /  button on your remote control and select  **Settings > System > Timer Settings**.

Adjust the timer settings to suit your preference.

- **Sleep Timer**

Set the sleep timer to automatically turn the TV off at the specified time.

Settings Overview

- **Power On Timer**

Set the time you want the TV to turn on automatically. You can set the same time each day or set a different time on different days.

- **Power Off Timer**

Set the time you want the TV to turn off automatically. You can set the same time each day or set a different time on different days.

- **Menu Timeout**

Set the amount of time you would like the menu to remain on the screen.

- **Auto Sleep**

Set the amount of time that you would like the TV to auto power off after a period of no activity.

This function may not be applicable in some models/countries/regions.

- **Auto Standby with No Signal**

TV will go to standby if there is no signal after the set time.

This function may not be applicable in some models/countries/regions.

Use System PIN

Press  /  button on your remote control and select  **Settings > System > System PIN**.

Change the PIN that you use to access Parental Control, Auto Channel Scan and Reset to Factory Defaults.

Set Language and Location

Press  /  button on your remote control and select  **Settings > System > Language and Location**.

Select the language used for this TV and your location.

- **Location**

Choose the location from where you will watch your TV.

- **Postcode**

User can change the Postcode. This function may not be applicable in some models/countries/regions.

- **Menu Language**

Set the default language for the TV menu.

- **Primary Audio**

Set the default audio output language for the type of digital broadcast content that you are viewing.

- **Secondary Audio**

Set the secondary audio output language for digital broadcast content.

- **Digital Teletext**

Adjust Teletext decoding.

Edit TV Name

Press  /  button on your remote control and select  **Settings > System > Advanced Settings > TV Name**.



You can edit the name for your TV to be used on the network.

Settings Overview



Note:

- Up to 18 characters can be entered.

Power Indicator Mode Setup

Press  /  button on your remote control and select  **Settings > System > Advanced Settings > Power Indicator**.

Set the power indicator display to stay On or Off when in Standby mode.



Press  /  button on your remote control and select  **Settings > System > Advanced Settings > Indicator Light Setting**.

Set the indicator light from **Power**, **Always** or **Off**.

Note:

- The above functions may not be applicable in some models/countries/regions.

Screensaver

Press  /  button on your remote control and select  **Settings > System > Advanced Settings > Screensaver**.

Activate a screensaver when your TV displays a still image for a period of time. Set the time according to your preference.

Note:

- This function may not be applicable in some models/countries/regions.

Related information

[Using the Art App](#) on page 31



Power on Settings Setup

Fast Power On

Press  /  button on your remote control and select  **Settings > System > Advanced Settings > Fast Power On**.



Enable TV fast start-up feature.

Power On Mode

Press  /  button on your remote control and select  **Settings > System > Advanced Settings > Power On Mode**.

The TV will turn on in the selected mode when the main power is reconnected.

Personalised Ads

Press  /  button on your remote control and select  **Settings > System > Advanced Settings > Personalised Ads**.



Turning off personalised ads will limit the ability to deliver relevant ads to you but will not reduce the number of ads you receive.

Settings Overview

Note:

- This function may not be applicable in some models/countries/regions.

Switch off Curtain

Press  /  button on your remote control and select  **Settings > System > Advanced Settings > Switch off Curtain.**

Enable or disable **Switch off Curtain** or set how quickly the Screen Curtain will close when entering standby.

Support

You can set up support settings.

Note:

- The menus displayed vary depending on models/countries/regions.

Check System Info



View system information.

Check Signal Info

Press  /  button on your remote control and select  **Settings > Support > System Info > Signal Info.**



Show the signal information of current input.

Check Network Connection Status

Press  /  button on your remote control and select  **Settings > Support > System Info > Network Connection Status.**

View the TV's network connection information.

Check Input Connection Status



Press  /  button on your remote control and select  **Settings > Support > System Info > Input Connection Status.**

View the TV's input connection information.

Check Software Version

To check the current software version of your TV, press  /  button on your remote control and select  **Settings > Support > System Info > Version.**

System Upgrade

Press  /  button on your remote control and select  **Settings > Support > System Upgrade.**

Set your TV to receive the latest firmware.

- **Auto Firmware Upgrade**

Set your TV to automatically receive the latest firmware.

Settings Overview

- **Check Firmware Upgrade**

Check to ensure that your TV has received the latest firmware.

Please ensure your TV is connected to the Internet.

- **Check OAD Upgrade**

Check to ensure that your TV has received the latest firmware via the tuner.

Note:

- Please ensure your TV is connected to the Internet.
- This function is only applicable when Thailand and Malaysia are selected in Location.

- **System App Auto Upgrade**

Set your system applications to automatically upgrade to the latest version. App auto upgrade will be completed in the background. Confirmation on new Privacy Notices may be required to complete any upgrades.

- **Upgrade from USB**

Upgrade TV software from USB device.

Note:

- Please ensure the USB flash drive is inserted to the USB 2.0 port of the TV.
- The update files must be located in the root directory of the update USB device.
- The format of the USB must be FAT32 and the partition table type must be MBR.



 **Related information**

[Connecting USB Devices](#) on page 40

Enjoy Safe Use of the TV

Press  /  button on your remote control and select  **Settings > Support > Disclaimer and Privacy > Terms & Conditions, Privacy Policy.**



Read the Disclaimer Details and Data Protection Policy. Allow/Deny your consent to the listed policies relating to the collection of User/Network data.

Press  /  button on your remote control and select  **Settings > Support > Disclaimer and Privacy > Remove User Data.**

To remove any usage data from the local TV and Cloud storage, select **Remove User Data.**

Check the TV Running Time

You can access the Status Check page to view the running time of your TV.



1. While in an input source, such as Live TV, HDMI and AV, press  /  button to launch the quick menu.
2. Under the quick menu, press and hold  [BLUE] button, the Status Check page will appear on screen for you to check the TV running time.

Note:

- This feature may not be applicable in some models/countries/regions.

Settings Overview

Using Parental Controls

Press  /  button on your remote control and select  **Settings > System > Parental Control**.

Turn on Parental Control to prevent children from being able to view certain content.

If you have not set the PIN code before, create and confirm PIN window will be displayed. Using the D-pad on the remote, create the PIN code.

If you have set the PIN code before, enter PIN window will be displayed.

- **Locks**

Turn on Locks to enable the Parental Control function.

You will see other Parental Control settings change from a greyed out state to highlighted. When this occurs, **Block Time**, **Channel Block**, **Content Block**, **Input Block**, **App Block**, or **Reset to Default** features are available to set.

- **Block Time**

Block the whole TV usage for a defined period of time, including Live TV, HDMI and apps.

- **Channel Block**

Block all or individual channels when you turn on the Parental Control feature.

- **Content Block**

Certain programmes are blocked by age rating. This is controlled by the broadcaster.

- **Input Block**

Block content from devices that are connected to external inputs.

- **App Block**

Block access to certain apps.

- **Reset to Default**

Restore Parental Control back to the factory default setting.

 **Related information**

[Use System PIN](#) on page 57

Reset to Factory Default

Press  /  button on your remote control and select  **Settings > Support > Reset to Factory Default**.

Restore your TV to the factory default. Reset will clear your personal settings, information and data. Enter the PIN code on-screen to enable the Factory Reset.

Game

Connect your game console and adjust the settings to optimise the TV screen for better gaming entertainment.

Connect a Game Console



You can connect your game console with a HDMI cable to the TV.

To start a game from a game console:

1. Switch on your game console.
2. Press **INPUT** /  button. Select the connected game console as the input source.
3. Start the game.

You can enable the game mode to optimise your TV's settings when playing games with a game console.

Game Mode

Press  /  button on your remote control and select  **Settings > Picture > Game Mode**.

Enable **Game Mode** to optimise the TV's settings to enjoy a better gaming experience with a PC or a game console connected to the TV.



Game Mode will allow:

- Reducing input lag to make sure every press or click matches what is happening on the screen;
- Improving responsiveness to produce very little motion blur;
- Processing YUV 4:4:4 format signals precisely to present accurate image colours.

Note:

- This function may not be applicable in some input sources or applications.

FreeSync

Press  /  button on your remote control and select  **Settings > Picture > FreeSync**.

Enjoy a smooth viewing experience with external devices connected to the TV when FreeSync is enabled.

Note:

- This function may not be applicable for some HDMI ports.
- This function may not be applicable in some models/countries/regions.

Sports

Sports mode setup in picture or sound settings



Press  /  button on your remote control and select  **Settings > Picture > Picture Mode > Sports**.

Optimised picture for watching sports.

Press  /  button on your remote control and select  **Settings > Sound > Sound Mode > Sports**.

Optimised sound for watching sports events.

Sports Mode Auto Detection



Press  /  button on your remote control and select  **Settings > System > Advanced Settings > Sports Mode Auto Detection**.

When enabled, any sports programmes will automatically switch to Sports mode for both Sound Mode and Picture Mode.

Note:

- This function may not be applicable in some models/countries/regions.
- Turning on this function could increase energy consumption.

Media

Press  /  button on your remote control and select **More Apps > Media**.



Media is a central location for you to view or listen to different types of content, such as photos, music and movies. You can view media content through the following methods:

- A USB thumb drive or hard drive.
- Compatible mobile phone, tablet or other personal devices: you can stream movies, music and photos that are stored on compatible personal devices and play or view the content on your TV.

By default, there is **Content Sharing** displayed on the Media screen. If your mobile device is connected to the TV, its name also appears on the Media screen.

For more information about **Content Sharing**, please refer to [Benefits of Smart TV > Content Sharing](#) in this manual.

Enjoy Photos/Audio/Video Stored on a USB Device

Press  /  button on your remote control and select **More Apps > Media > connected devices**.

Select the content you want to play on the screen, like pictures, videos and music.

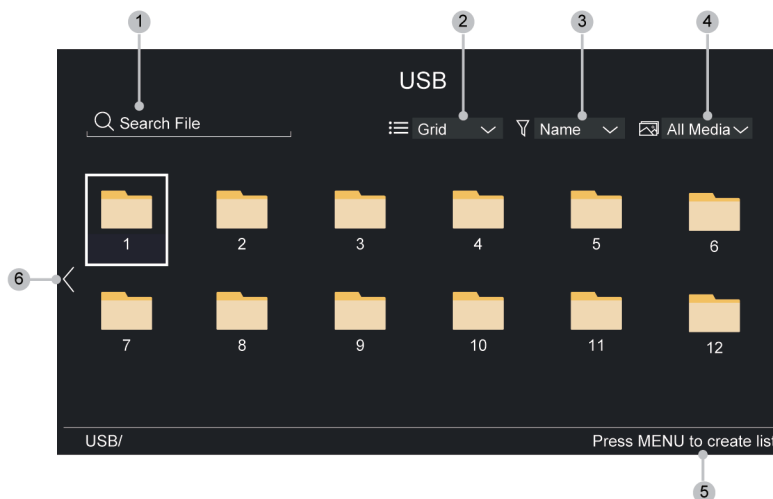

1. Search the content you want to play.

Entertainment

2. Arrange the content list by **Grid, List**.
3. Sort the content list by **Name, Date Modified, Size**.
4. Filter the content list by **All Media, Photo, Video, Music, Recorded**.
5. Create a photo, music, or video playlist.
6. When the focus is on the first line, there will be an arrow on the left side. Select the arrow to enter multiple storage sources.

Note:

- Some options in the above table may not be available in some models/countries/regions.
- You must obtain any required permission from copyright owners to download or use copyrighted content. We cannot and don't grant such permission.

Play Background Music while Viewing Pictures

1. Choose a picture to display.
2. Press **▲** / **▼** button to display control bar.
3. Select **Background Music** and choose your music to create a Music Playlist.

Now you can play background music while viewing pictures.

Audio Format

Due to differences in programming tools and other factors, some of the file formats that are listed may not be supported.

The listed formats may not be supported depending on the model.

Container	File Extension Name
LPCM	.wav
MPEG1/2 Layer1	.mp3
MPEG1/2 Layer2	.wma
MPEG1/2/2.5 Layer3	.flac
WMA	
AAC	
MPEG-H	
FLAC	
VORBIS	

Photo Format

Due to differences in programming tools and other factors, some of the file formats that are listed may not be supported.

The listed formats may not be supported depending on the model.

Container	File Extension Name	Mode of Operation	Resolution
JPEG	.jpg .jpeg	base-line	15360 x 8640
		progressive	1024 x 768

Entertainment

Container	File Extension Name	Mode of Operation	Resolution
PNG	.png	no-interlace	9600 x 6400
		interlace	1200 x 800
BMP	.bmp	-	9600 x 6400
GIF	.gif	-	6400 x 4800

Video Format

Due to differences in programming tools and other factors, some of the file formats that are listed may not be supported.

The listed formats may not be supported depending on the model.

Codec Name	File Extension Name	Sampling rate
MPEG1/2	.mp4	1920 x 1080p @ 60fps
MPEG4	.mov	1920 x 1080p @ 60fps
AVC(H.264)	.mkv	4096 x 2160p @ 120fps
HEVC(H.265)	.ts	4096 x 2160p @ 120fps
WMV3	.avi	1920 x 1080p @ 60fps
VC1	.wmv	1920 x 1080p @ 60fps
VP8	.flv	1920 x 1080p @ 60fps
VP9	.webm	4096 x 2160p @ 120fps
AV1		4096 x 2160p @ 120fps

THIS PRODUCT IS LICENSED UNDER THE AVC PATENT PORTFOLIO LICENSE FOR THE PERSONAL USE OF A CONSUMER OR OTHER USES IN WHICH IT DOES NOT RECEIVE REMUNERATION TO (i) ENCODE VIDEO IN COMPLIANCE WITH THE AVC STANDARD ("AVC VIDEO") AND/OR (ii) DECODE AVC VIDEO THAT WAS ENCODED BY A CONSUMER ENGAGED IN A PERSONAL ACTIVITY AND/OR WAS OBTAINED FROM A VIDEO PROVIDER LICENSED TO PROVIDE AVC VIDEO. NO LICENSE IS GRANTED OR SHALL BE IMPLIED FOR ANY OTHER USE. ADDITIONAL INFORMATION MAY BE OBTAINED FROM MPEG LA, L.L.C. SEE [HTTP://WWW.MPEGLA.COM](http://www.mpegla.com)

Accessibility Features

Accessibility Menu Setup

Provide menu option to aid the visually or hearing impaired.

Press  /  button on your remote control and select  **Settings > Accessibility > High Contrast Menu.**

Improve contrast for visually impaired.

Press  /  button on your remote control and select  **Settings > Accessibility > Menu Transparency.**



Select menu transparency from **Off, Medium, High.**

Note:

- The above functions may not be applicable in some models/countries/regions.

Audio Type Setup

Provide audio description to aid the visually impaired.

Press  /  button on your remote control and select  **Settings > Accessibility > Audio Type.**

- **Audio Type**

Accessibility audio settings.

- **Audio Format**

Select the audio format.



- **Fader Control**

Provide the best sound quality options for the visually impaired.

Note:

- The above functions may not be applicable in some models/countries/regions.

Dialogue Enhancement

Press  /  button on your remote control and select  **Settings > Accessibility > Dialogue Enhancement.**

Enable or disable dialogue enhancement.

Note:

- This function may not be applicable in some models/countries/regions.

Subtitle Setup

Adjust Subtitle Settings for digital broadcast content.

Press  /  button on your remote control and select  **Settings > Accessibility > Subtitle Settings.**

- **Subtitle**

Enable Subtitle type.

- **Primary Subtitle**

Set the default subtitle language for digital broadcast content.

- **Secondary Subtitle**

Set the secondary subtitle language for digital broadcast content.

Accessibility Features



- **Channel Subtitle Storage**

Enable the storage of subtitle settings per channel.

Note:

- The above functions may not be applicable in some models/countries/regions.

Screen Magnification



Press  /  button on your remote control and select  **Settings > Accessibility > Screen Magnification**.

Allow visually impaired/partially sighted viewers to magnify an area of the screen.

Note:

- This function is only applicable for some scenarios.
- This function may not be applicable in some models/countries/regions.

Voice Guide

Press  /  button on your remote control and select  **Settings > Accessibility > Voice Guide**.

Adjust settings for the Menu Audio function.

- **Voice Guide**

Enable or disable Voice Guide.

- **Volume**

Set the Menu Audio volume.

- **Language**

Set the Menu Audio language.

- **Rate**

Set the Menu Audio speed.

- **Pitch**

Set the Menu Audio pitch.

- **Focus Voice Guide**

Turn down the background volume when Menu Audio is playing.

Note:

- This function may not be applicable in some models/countries/regions.

Troubleshooting

FAQ

In this section you will find the answers to the most frequently asked questions.

There is no picture, or the picture is black and white.

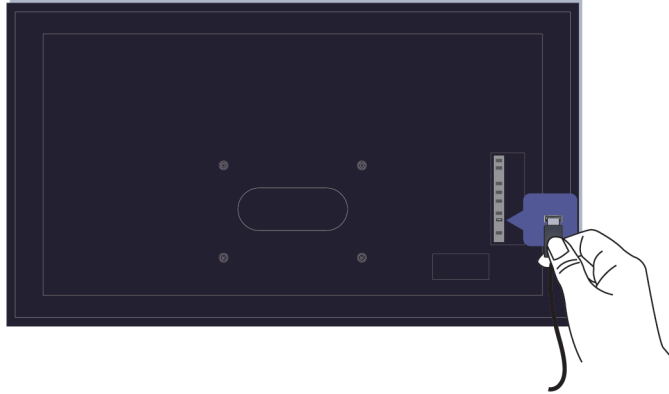

Check input cable connections.

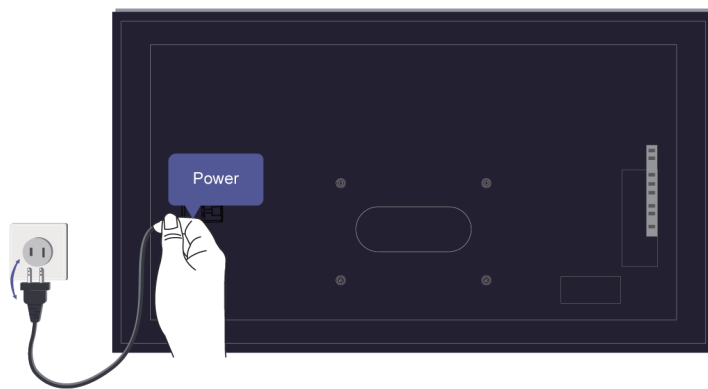

Unplug the TV power cord from AC outlet and re-plug after 60 seconds.

Troubleshooting

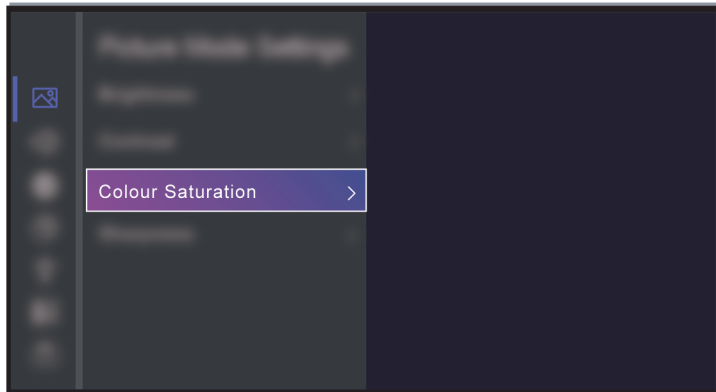

Check if the Colour Saturation is set to 50 or higher at  /  >  **Settings > Picture > Picture Mode Settings > Colour Saturation.**

No sound or the sound is too low.

There is no sound or the sound is too low at maximum volume.

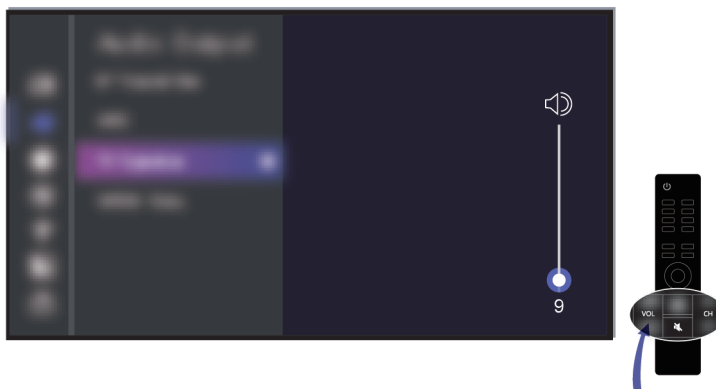

Check if Mute mode is set to on.

Check the volume settings.

Check the volume control of the device (cable or satellite box, DVD, Blu-ray, etc.) connected to your TV.

Troubleshooting

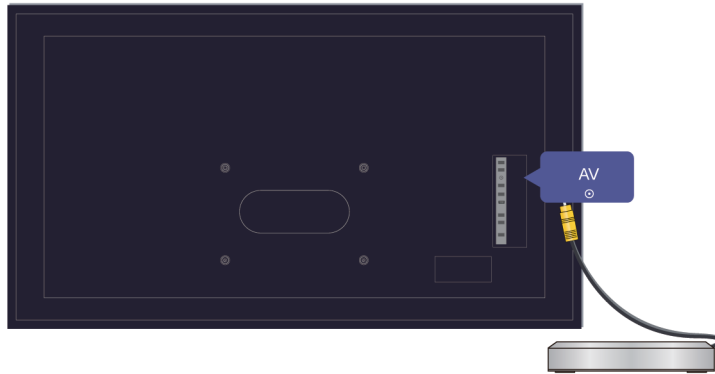

Make sure that the audio cable is connected to the correct audio output connector on the external device.

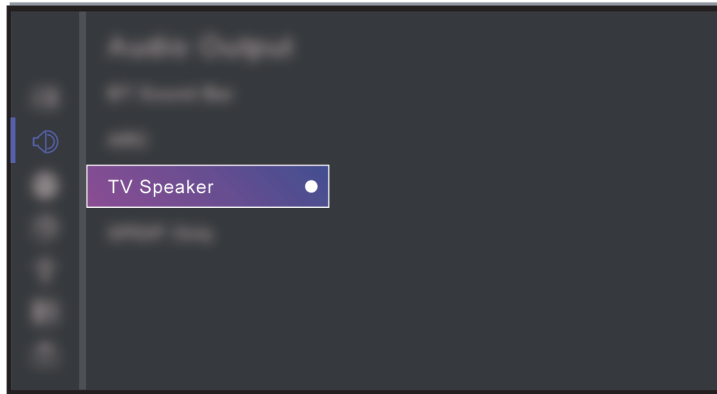

Check whether **TV Speaker** is selected at   >  **Settings** > **Sound** > **Speakers** > **Audio Output**.

My TV cannot connect to the network.

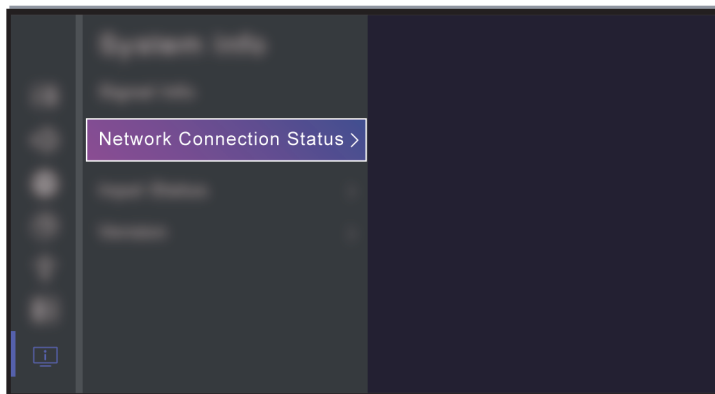

Check network status at   >  **Settings** > **Support** > **System Info** > **Network Connection Status**.

Troubleshooting

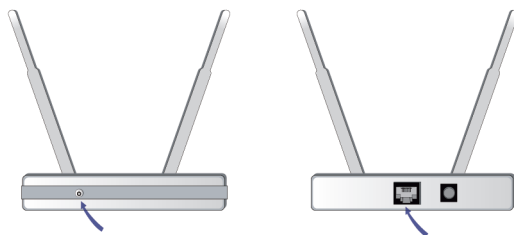

Make sure your modem/wireless router is on and connected to the Internet.

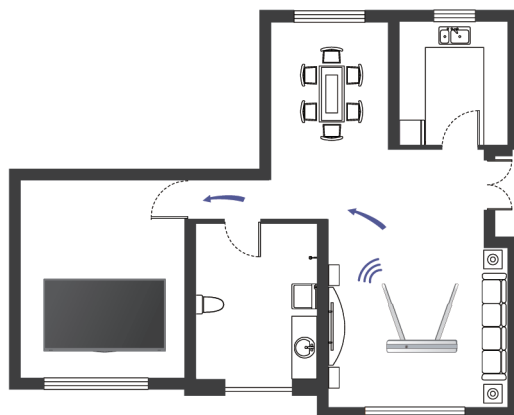

Position your wireless router, modem router, or access point in a central location. Avoid putting it in a corner.

External source connected but no picture or sound.

I have connected an external source to my TV but I get no picture and/or sound.

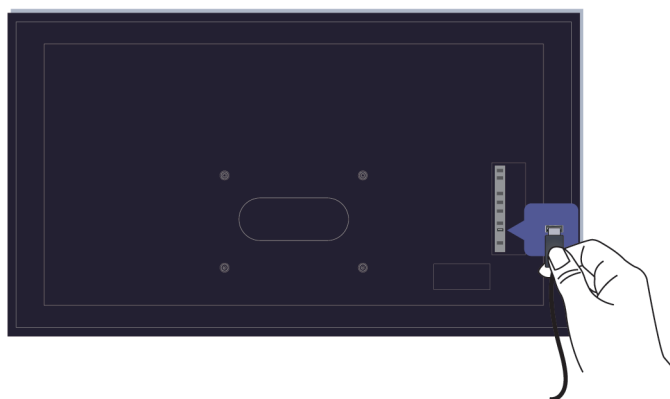

Check whether the connection between the external device and your TV is correct and secure.

Troubleshooting

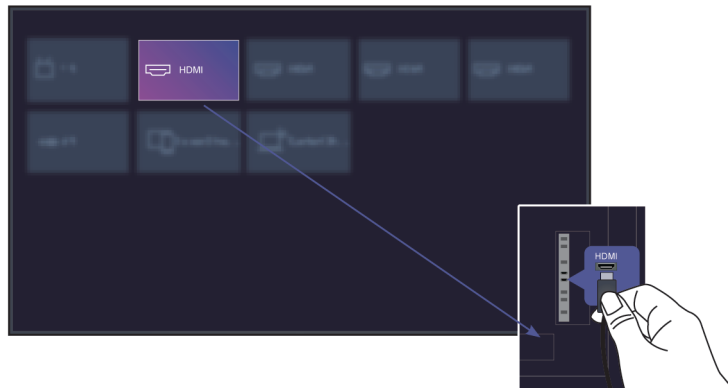

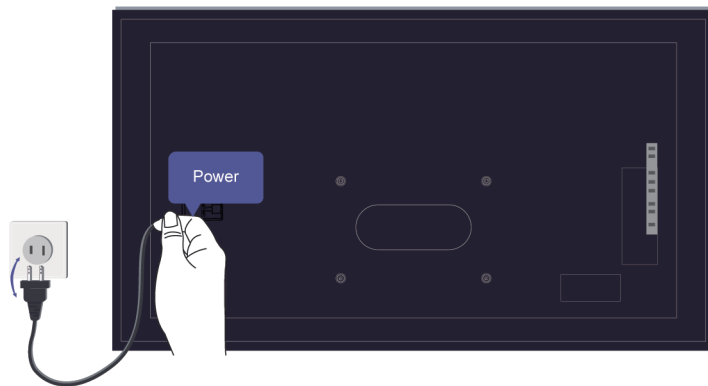

Make sure you have made the correct selection of input source.



If the signal is intermittent, unplug the TV power cord from AC outlet and re-plug after 60 seconds.

When devices are connected with HDMI cables

- If there is always no signal, or the signal cannot be restored after plugging and unplugging, you can access  /  >  **Settings** > **System** > **HDMI & CEC** > **HDMI Format**, to confirm whether the signal can be recognised.
- Change to another HDMI port.
- Change to another HDMI cable.

The remote control does not work.

Confirm that TV still has power and is operational. Press the power button on the TV to determine if the problem is with the remote control or not.

Troubleshooting



If the TV is not responding to the remote control, then please check if the small light on the remote control flashes when any button is pressed (some remote controls do not support this function).

If the small light does not flash when the remote control button is pressed, the battery power may be low, please replace the batteries with new ones.

Check that the orientation of each battery matches the positive (+) and negative (-) symbols in the battery compartment.





Keep the remote control sensor area clear from obstacles.

Troubleshooting

For Bluetooth remote controls



If the TV does not respond with the Bluetooth remote control, try pairing the remote control to the TV by pressing and holding the  /  button for at least 3 seconds.

Schedule Recording cannot be used.

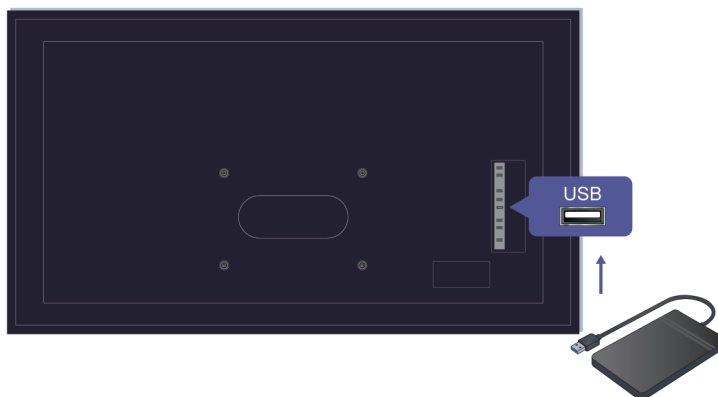

Check if there is a storage device connected to the TV.

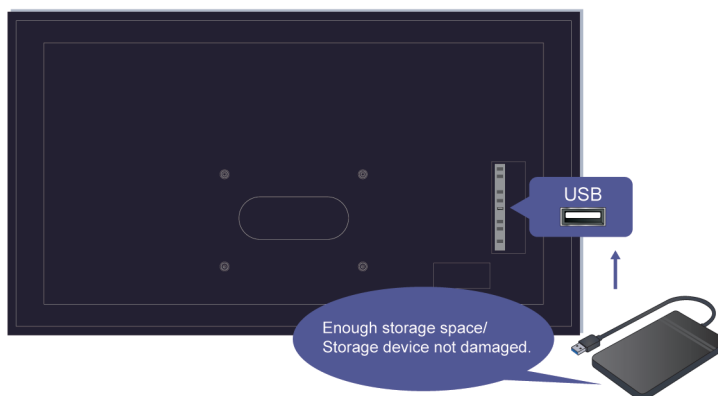

Troubleshooting

Check the free space of the storage device. The function will not work if there is not enough storage space on the device.

Check whether your storage device is damaged. If so, it is suggested to format your storage device.

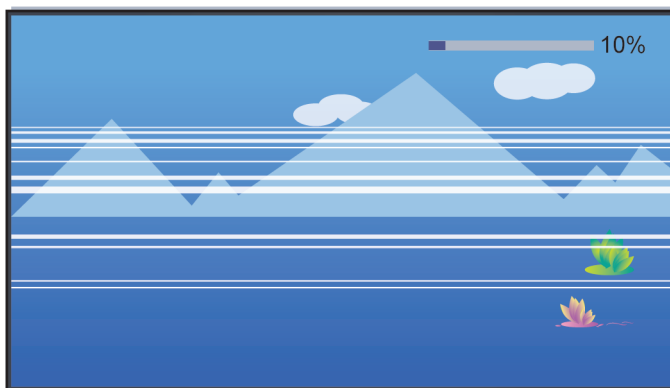



Recording will automatically stop if the signal becomes too weak.

Note:

- Recording function may not work if the read/write speed of the USB device is too slow.
- Recording function may not work because the storage format of your device is unsupported.
- The Recording functions may not be applicable in some models/countries/regions.

TV Status Diagnosis

Press  /  button on your remote control and select  **Settings > Support > Self Diagnosis**.

When the TV malfunctions, you can perform some self-diagnosis to find the problem.

• **Picture Test**

When performing the Picture Test, a test picture will be shown on screen. Select OK to start the test. Picture Test displays a high-definition picture that you can examine for flaws or faults. Please check the picture carefully in the next 10s.

• **Sound Test**

When performing the Sound Test, a test sound will be played with the TV Speaker. Select OK to start the test. Please listen to the sound carefully to check whether you can hear the sound problem.

• **Network Test**

When performing a Network Test, the test will confirm whether your TV is connected to network via the TV screen. If the network test is successful but you still have problems using online services, please contact your Internet provider.

• **Bandwidth Monitoring**

Test the speed with a third-party website.

• **Input Connection Test**

When performing an Input Connection Test, you can select from the input sources and check related information with external connections.

Troubleshooting

- **Status Check**

When performing a Status Check, the status of your TV will be displayed showing any error codes.

Remote Control Service

Press  /  button on your remote control and select  **Settings > Support > Remote Control Service.**

Remote Control Service enables your TV to be controlled from the client server to allow service agents to diagnose the problem of your TV and deal with the problem online efficiently.

To use this function:



1. Turn on **Remote Control Service.**
2. Select **Agree All** and **Confirm** in End User License Agreement page.
3. Select **Generate PIN** in Remote Control Service.
4. You can initiate a help request to a service agent by the hotline and provide the on-screen PIN.

Note:

- This function may not be applicable in some models/countries/regions.
- Steps above may vary. Please refer to the specific product.
- Keep the network connected when the Remote Control Service is running.

Picture Issues

When the TV has a picture problem, these steps may help resolve the problem.

Press  /  button on your remote control and select  **Settings > Support > Self Diagnosis > Picture Test.**

Before you review the list of problems and solutions below, use **Picture Test** to determine if the problem is caused by the TV. **Picture Test** displays a high definition picture that you can examine for flaws or faults.

- If the test picture does not appear or there is noise or distortion, the TV may have a problem. Contact the service company in your country/region.
- If the test picture is displayed properly, there may be a problem with an external device. Please check the connections.
- If the problem persists, check the signal strength or refer to the external device's user manual.

Problem	Possible Solutions
The picture is distorted.	<ul style="list-style-type: none">• The compression of video content may cause picture distortions, especially in fast moving pictures from sports programmes and action movies.• If the signal reception is weak or poor, screen distortion may be visible but it is not a malfunction.• Mobile phones used close to the TV (within 1m) may cause noise on analogue and digital channels.

Troubleshooting

Problem	Possible Solutions
The picture is blurry or flickering, or cuts out momentarily.	<ul style="list-style-type: none"> Press / button on your remote control and select Settings > Picture > Picture Mode Settings > Sharpness. You can try to increase or decrease the Sharpness. If you use an external antenna, check the direction, position and connection of the antenna. Adjust the direction of your antenna, or reset or fine tune the channel.
The picture appears red, purple, pink and other colours.	<ul style="list-style-type: none"> Press / button on your remote control and select Settings > Picture > Picture Mode Settings > Expert Settings > White Balance. You can try to increase or decrease the White Balance.
Picture distorted or appears wavy.	<ul style="list-style-type: none"> Some electrical appliances may affect the TV. If you turn off the appliance and the interference goes away, then move it further away from TV. Insert the power plug of the TV into another power outlet.

Related information

[There is no picture, or the picture is black and white.](#) on page 68

Sound Issues

When the TV has a sound problem, these steps may help resolve the problem.

Press / button on your remote control and select **Settings** > **Support** > **Self Diagnosis** > **Sound Test**.

If the TV plays the **Sound Test** melody without distortion, there may be a problem with an external device or the broadcast signal's strength.

Problem	Possible Solutions
Picture is normal, but no sound.	<ul style="list-style-type: none"> Check the volume settings. Check if 'Mute' mode is set to on. Check the volume control of the device (cable or satellite box, DVD, Blu-ray, etc.) connected to your TV.
The speakers are making an odd sound.	<ul style="list-style-type: none"> Make sure that the audio cable is connected to the correct audio output connector on the external device. For antenna or cable connections, check the signal information. A low signal level may cause sound distortions.
Sound is distorted.	<ul style="list-style-type: none"> Some electrical appliances may affect the TV. If you turn off the appliance and the interference goes away, then move it further away from TV. Insert the power plug of the TV set into another power outlet.
Sound is distorted or cuts out momentarily.	<ul style="list-style-type: none"> If you use an external antenna, check the direction, position and connection of the antenna. Adjust the direction of your antenna or reset or fine tune the channel.

Troubleshooting

☰ Related information



[No sound or the sound is too low.](#) on page 69

Network Issues

When the TV has difficulties in connecting to the Internet, these steps may help resolve the problem.

Press  /  button on your remote control and select  **Settings > Support > Self Diagnosis > Network Test.**

The test can identify whether IPv4 or IPv6 has connected successfully.





Problem	Possible Solutions
The TV cannot connect to apps.	<ul style="list-style-type: none">• Make sure the TV has a network connection.• Press  /  button on your remote control and select  Settings > Support > Self Diagnosis > Network Test.• Contact your Internet service provider.
The wireless network connection failed.	<ul style="list-style-type: none">• Make sure your wireless modem/router is on and connected to the Internet.
The wireless network signal is too weak.	<ul style="list-style-type: none">• Position your wireless router, modem router, or access point in a central location. Avoid putting it in a corner.

☰ Related information

[My TV cannot connect to the network.](#) on page 70

Channel and Broadcast Issues

For problems while watching live TV or scanning for new services, these suggestions might help to resolve any issues.

Problem	Possible Solutions
In Live TV, there is no signal, or a weak signal, or you cannot find any channels.	<ul style="list-style-type: none">• Make sure that the antenna cable is connected to the correct port.• Make sure that the antenna cable is not loose or disconnected.• If "no signal or weak signal" occasionally happens, disconnect antenna cable and reconnect it.• Run Reset to Factory Default or scan channels again. <p>Press  /  button on your remote control and select  Settings > Support > Reset to Factory Default.</p> <p>In Live TV, press  /  button on your remote control and select Settings > Channel > Auto Scan/Advanced Settings > Manual Scan.</p>

☰ Related information













[Prepare Live TV](#) on page 8

[Channel Scan](#) on page 11

Troubleshooting

External Device Connection Issues

When the TV has difficulties with external device connection, these solutions may help resolve the problem.



Problem	Possible Solutions
The TV is having trouble receiving a signal from an external set top box.	<ul style="list-style-type: none">• If there is no signal occasionally, unplug cable from TV and re-plug after 60 seconds.• If there is always no signal, or the signal cannot be restored after plugging and unplugging, you can press  /  button on your remote control and select  Settings > System > HDMI & CEC > HDMI Format, to confirm whether the signal can be recognised.• Change to another HDMI port.• Change to another HDMI cable.
There is no sound.	<ul style="list-style-type: none">• Check whether ARC is selected at  /  >  Settings > Sound > Speakers > Audio Output. If not, you need to check whether the external power amplifier device is connected to the ARC/eARC port or optical port of the TV.• Press  /  button on your remote control and select  Settings > Sound > Speakers > Digital Audio Output. You can try to select PCM, Dolby Audio - Dolby Digital, or Dolby Audio - Dolby Digital Plus.• Whether the power amplifier device port is connected correctly.• If you select HDMI as input, you can press  /  button on your remote control and select  Settings > System > HDMI & CEC > HDMI Format to check whether format is correctly selected.

Related information

[External source connected but no picture or sound](#) on page 71

HDMI & CEC Issues

When HDMI & CEC is not working, these steps may help resolve the problem.

Problem	Possible Solutions
HDMI & CEC does not work.	<ul style="list-style-type: none">• Confirm that the device is a HDMI & CEC compatible device.• Check if the power cable of the HDMI & CEC device is properly connected.• Check the cable connection of the HDMI & CEC device is secure.• Check HDMI & CEC feature of your TV is turned on. <p>Press  /  button on your remote control and select  Settings > System > HDMI & CEC > CEC Control.</p> <ul style="list-style-type: none">• Check HDMI & CEC feature of the connected device is turned on.• Depending on the connected HDMI device, the HDMI & CEC control feature may not work.

Troubleshooting

☰ Related information

[Use HDMI & CEC](#) on page 35

Media Files

When files will not play, this may help resolve the problem.

Problem	Possible Solutions
Some files cannot be played.	<ul style="list-style-type: none">Most files can be played back, but you might experience problems with corrupted files or files with high-bitrate, unsupported resolution, unsupported container or codec formats.

☰ Related information

[Media](#) on page 63

Voice Service Issues

When some Voice service will not function, this may help resolve the problem.

Problem	Possible Solutions
Alexa cannot be heard.	<ul style="list-style-type: none">You can try to log into your Amazon account.If you hear "I don't understand" from the voice recognition, please change account or log out of the account.For more information about Alexa, please refer to Benefits of Smart TV > Voice Service Setup > Alexa Setup in this manual.
Google Assistant cannot be heard.	<ul style="list-style-type: none">You can try to log in to Google account.If you hear "I don't understand" from the TV, please change account or log out of the account.After logging in to the Google account, the recognition language may be different. You need to log in to the Google account on the web page to set the voice language.For more information about Google Assistant, please refer to Benefits of Smart TV > Voice Service Setup > Google Assistant in this manual.

Other Issues

Use these procedures to resolve other issues that may occur.

Problem	Possible Solutions
The TV is hot.	<ul style="list-style-type: none">Watching TV for an extended period of time causes the panel to generate heat. The heat from the panel is dissipated through internal vents running along the top of the TV.After extended use, you may feel heat when touching it. This heat is not a defect and does not affect the TV's functionality.
The TV smells of plastic.	<ul style="list-style-type: none">This smell is normal and will dissipate over time.

Troubleshooting

Problem	Possible Solutions
The plastic cabinet makes a "clicking" type of sound.	<ul style="list-style-type: none">• The "clicking" sound can be caused when the temperature of the TV changes. This change causes the TV cabinet to expand or contract, which makes the sound. This is normal and the TV is OK.
When I turn on my TV, there is a delay for a few seconds before the picture appears. Is this normal?	<ul style="list-style-type: none">• Yes, this is normal. The TV is initialising and searching for the previous setting information.