

INSTRUCTIONS FOR USE

Induction hob with integrated extractor

EN

HIHD854MF

HIHD854GF

HIHD854MM

Contents

Pictograms used	3	Child lock	37
Safety	4	Time functions	37
Safe use	8	Operating the extraction module	39
'Open window' function	9	ConnectLife and Wi-Fi	41
Power management	9	ConnectLife -app and Wi-Fi connection	41
Your hob with integrated extractor	11	Firmware Update	43
Dear customer!	11	Settings	44
These instructions	11	Maintenance	48
Description	13	Cleaning glass top	48
Control panel	14	Cleaning the extraction module	48
Indications on the display	17	Filter indication	51
Use	18	Replacing recirculation filter (when using the recirculation box)	51
Induction cooking	18	Troubleshooting	52
Induction sounds	20	General	52
Pans for induction cooking	20	Troubleshooting table	52
Cooking settings	22	Technical data	56
Using the extraction module	23	Information according to regulation (EU) 66/2014	56
Operation	26	EU Product Fiche	57
Start Preparing	26	Compliance information	57
Standard cooking	26	Environmental aspects	58
Cooking with the PLUS menu	28	Disposal of the appliance and packaging	58
Cooking with Celsius°Cooking™	30	Installation	59
Cooking with Celsius°Cooking™ cookware and programs	31	Safety	59
Step-by-Step cooking guide on CelsiusCooking.com	35	Preparations for installation	60
Bridge Induction zone	35	Built-in	66
Pause	36		

The following symbols are used throughout the manual, and they have the following meanings:

 INFORMATION!

Information, advice, tip, or recommendation

 WARNING!

Warning – general danger

 ELECTRIC SHOCK!

Warning – danger of electric shock

 HOT SURFACE!

Warning – danger of hot surface

 DANGER OF FIRE!

Warning – danger of fire

 RIGHT!

 WRONG!

It is important that you carefully read the instructions.

READ CAREFULLY AND KEEP IT FOR FUTURE REFERENCE!

General

The manufacturer cannot be held liable for any damage resulting from failure to follow the safety instructions and warnings.

Damage caused by incorrect connection, incorrect fitting, or incorrect use is not covered by the warranty.

WARNING!

This appliance can be used by children aged from 8 years and above and persons with reduced physical, sensory or mental capabilities or lack of experience and knowledge if they have been given supervision or instruction concerning use of the appliance in a safe way and understand the hazards involved.

This appliance and the accessible parts will become hot during use. Do not touch hot parts. Keep children younger than 8 away from the appliance unless they are under continuous supervision.

Children shall not play with the appliance. Cleaning and user maintenance shall not be made by children without supervision.

DANGER OF FIRE!

WARNING: Danger of fire: do not store items on the cooking surfaces.

NOTE!

CAUTION! The cooking process has to be supervised. A short-term cooking process has to be supervised continuously.

DANGER OF FIRE!

WARNING: Cooking with fat or oil on a hob without supervision can be dangerous and can lead to a fire.

NEVER try to extinguish a fire with water. Instead, switch the appliance off and then cover the flames with, for example, a lid or a fire blanket.

WARNING!

Use only hob guards designed by the manufacturer of the cooking appliance or indicated by the appliance manufacturer in the instructions for use as suitable or hob guards incorporated in the appliance. The use of inappropriate guards can cause accidents.

If a drawer underneath the appliance is permitted (see the installation instructions), without an intermediate bottom, this should not be used to store highly flammable objects/materials. Ensure that there is adequate clearance of a few centimetres between the bottom of the hob and the contents of any drawers.

The hob is only to be used for the preparation of food.

This appliance is only designed for household use.

The appliance is not designed for heating rooms.

The appliance is not intended to be operated by means of an external timer or separate remote control system.

Never use a steam cleaner for cleaning the appliance. Only clean the appliance when switched off. The steam of a steam cleaner could reach the conducting parts and cause an electrical short.

The hob is fitted with a Wi-Fi module that allows the appliance to connect to a mobile device such as a smartphone or tablet. It offers to monitor the cooking hob status via the mobile device. For safety reasons, it is not possible to remotely control, turn on or turn off the hob. The monitoring function via mobile device shall not be used to replace the personal supervision of the cooking process directly at the hob.

If you decide to discontinue using the appliance because of a fault, we recommend you cut off the cable after removing the plug from

the plug socket. Take the appliance to your municipality's waste disposal site.

WARNING: If the surface is cracked, switch off the appliance to avoid the possibility of electric shock.

Ceramic glass plate broke

- Shut immediately off all burners and any electrical heating element and isolate the appliance from the power supply.
- Do not touch the appliance surface.
- Do not use the appliance.

Induction use

Do not place metal objects such as knives, forks, spoons, and lids on the surface of the cooking hob; they may become hot.

When the induction hob is in use, keep objects that are sensitive to magnetic fields (credit cards, bank cards, discs, watches and similar items) away from the hob. We advise anyone with a pacemaker to consult their cardiologist first.

Never use aluminium foil for cooking, and never place products packaged in aluminium on the hob. The aluminium would melt and irreparably damage your device.

Extraction use

 **WARNING!**

Life-threatening, the danger of poisoning through back-drafting of combustion gasses!

Never use the appliance to extract air while using a cooker that consumes air from the room unless the room is sufficiently ventilated. Cooking appliances that consume air in the room (such as equipment that heats using gas, oil, wood or coal, geysers, and hot water appliances) draw the combustion air out of the room and carry these gasses outside via the outlet (e.g. chimney). In combination with an activated cooker hood, the air is withdrawn from the kitchen and the adjacent rooms. This creates negative pressure if there is an insufficient air supply. Poisonous gasses from the chimney or outlet channel are back-drafted into the living area.

Always provide adequate ventilation!

When the extraction unit and appliances supplied with energy other than electricity are simultaneously in operation, the negative pressure in the room must not exceed 4 Pa (4×10^{-5} bar).

Local regulations concerning the discharge of air have to be fulfilled.

ELECTRIC SHOCK!

Avoid the risk of electric shock; make sure the appliance is switched off before cleaning the appliance.

Do not use the extraction unit if the grease filter has not been fitted properly!

To prevent hot fat from catching fire, you should only deep-fry under continuous supervision.

Clean the filters on time.

Follow the instructions in the manual for cleaning or replacing the grease filters and/or carbon filters!

DANGER OF FIRE!

There is a risk of fire if the instructions for cleaning or replacing grease filters and/or carbon filters are not followed. Consult chapter '*Maintenance*' concerning the details of the method and frequency of cleaning.

Safety

Grease deposits in the metal grease filters can cause a fire. Never flambé on a cooking zone with the extractor switched on. The high flames can cause a fire. Always use the appliance with the metal grease filter. Clean the grease filter regularly.

Overheated fat or oil can start a fire. Always supervise the heating of fat and oil. Never extinguish a fire with water; always use a fire blanket, lid or plate.

Safe use

- Do not keep objects that children might find interesting in cupboards above or behind the appliance.
- Do not warm closed tins on the hob. There will be a build-up of pressure that will cause tins to explode. You might get injured or scalded.
- Do not use the appliance in temperatures below 5 °C.
- The appliance should not be placed or used outdoors.
- When you use the hob for the first time, you will notice a “new smell”. Don't worry, this is normal. If the kitchen is well ventilated, the smell will soon disappear.
- Never open the casing of the appliance.
- As soon as you remove the pan from the hob, the cooking process will stop automatically. Get into the habit of switching off the cooking zone or hob manually to avoid unintentionally switching on the appliance.
- After use, switch off the hob element using the controls and don't rely only on the pan detector.
- Remember that if the hob is used in a high setting, the heating time will be very short. Do not leave the hob unattended if you are using a zone in a high setting.

Temperature safety

- The hob is fitted with a cooling fan which cools the electronic components during cooking. The fan may operate for a while, even after the end of the cooking process.
- The induction cooking hob is also fitted with an overheating protector which protects the electronic components from damage. The protector operates in several ways. When the cooking zone temperature gets very high, the cooking power is automatically reduced. If this does not suffice, the cooking zone power continues to decrease, until the safety mechanisms switch off the cooking zone completely. When the cooking hob is cooled down, its total power will be available again.

Cooking time limiter

WARNING!

The cooking-time limiter is a safety function of your cooking appliance. It will operate if you forget to switch off your hob.

Depending on the setting you have chosen, the cooking time will be limited as follows:

Setting	The cooking zone switches off automatically after:
1 and 2	9 hours
3, 4 and 5	6 hours
6, 7 and 8	4 hours
9	3 hours
10	2 hours
11 and 12	1 hour

The cooking-time limiter switches the cooking zones off if the time in the table has elapsed.

Setting	The cooking zone switches automatically to setting 12 after:
Boost	10 minutes

NOTE!

The Cooking-time limiter for the specific cooking zone is reset after the user has changed the cooking level of the specific cooking zone.

NOTE!

Cooking zone related timers take priority over the cooking-time limiter.

'Open window' function

If it is prescribed that an extraction unit, which is located in a room where a fireplace is present, may only be used when a (kitchen) window is open, then a window sensor must be installed.

The 'open window' function is automatically activated as soon as an 'open window' sensor is connected to the appliance. The use of an 'open window' sensor type 'FDS 100' is recommended.

Power management

This induction hob is equipped with a smart power management system. This system ensures a maximum permissible power cannot be exceeded for safety reasons.

- The smart power management system will arrange the power distribution across the zones automatically. This means the hob could automatically decrease the power on one zone when the power level of another zone is increased. The level of activity of the power management system depends on the available power per electrical phase, the setting of the current limiter and the connected load.
- The power level of one zone can affect the power of another zone as the maximum available power is distributed among the zones. If the combined zones reach the maximum available power when a new power level is set, the power levels of one or more zones are automatically reduced within the power limit. This is indicated by the flashing of the relevant control element.
- In case a zone is used for Celsius°Cooking™, this zone always gets the highest priority.

Safety

- Intervention by the smart power management system is more likely when the current limiter is set to a lower level.
- The current limiter setting must be set according to your connection and circuit breakers by a registered and qualified installer (see '*Installation*' for the details on currents and electrical installation).

Your hob with integrated extractor

Dear customer!

Welcome to our growing ASKO family!

We are proud of our appliances. We hope that this appliance will be an appreciated and dependable aid for many years to come.

Please read the operating instructions before use. They include general tips, information about the settings and adjustments you can make, and the best way to take care of your appliance.

The manual also serves as reference material for service technicians. **Please, therefore, stick the appliance identification card in the space provided at the back of the manual.** The appliance identification card contains all the information that the service technician will need in order to respond appropriately to your needs and questions.

TIP!

You can find the most recent version of the instructions for use on our website.

Enjoy your cooking!

These instructions

These instructions are written for:

- The user; to quickly become familiar and make optimal use of the appliance.
- An installer; to install the appliance in accordance with the applicable standards.

The table below gives you information on the different chapters you can find in order in these instructions.

Chapter	Page	Purpose
<i>Pictograms used</i>	3	Explains the pictograms used in these instructions.
<i>Safety</i>	4	Provides information, warnings and tips on using the appliance safely so that you will not get hurt and the device will not malfunction. Always read this section thoroughly before using the appliance.
<i>Your hob with integrated extractor</i>	11	Describes the available functions of the appliance. The tables clearly show what the different keys can be used for. The various possible displays and messages on the appliance are also explained.
<i>Use</i>	18	This chapter finds information on the operation and use of induction and the exhaust module. You will also find advice on the cookware to be used and information on cooking levels.
<i>Operation</i>	26	It gives you step-by-step information on how to operate the device. The steps include illustrations that consist of a left-side drawing showing the action (which key to touch) and a right-side drawing showing the reaction of the device.
<i>ConnectLife and Wi-Fi</i>	41	Refer to this section if you want to connect the appliance to Wi-Fi in your home. It also describes how to use the ConnectLife app and how to update the appliance firmware.

Your hob with integrated extractor

Table continued from last page

Chapter	Page	Purpose
<i>Settings</i>	44	You can fully customise this induction hob to your cooking style! Several settings can be adjusted. This chapter also contains settings for the installer.
<i>Maintenance</i>	48	Provides information on cleaning and maintaining your device.
<i>Troubleshooting</i>	52	If the appliance does not work correctly or displays unclear messages, please refer to this section.
Technical data	56	Describes the technical data and specifications of your appliance.
<i>Environmental aspects</i>	58	It gives you packaging information and how to dispose of the appliance responsibly at the end of its life.
<i>Installation</i>	59	This chapter is intended for the installer. Only a qualified installer may install this appliance.

Your hob with integrated extractor

Description

Since the appliances for which these instructions were drawn up may have different equipment, some functions or equipment may be described in the manual that may not be present in your appliance.

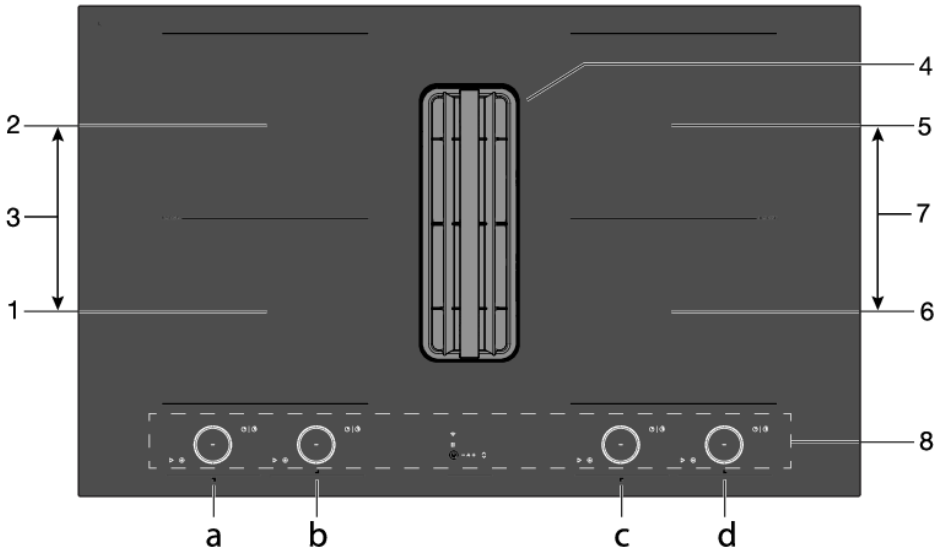

1. Bridge Induction Cooking zone 18 x 22 cm / max. 2.3 kW / max. 3.7 kW (boost) to be operated with 'a'
2. Bridge Induction Cooking zone 18 x 22 cm / max. 2.3 kW / max. 3.7 kW (boost) to be operated with 'b'
3. Connected Bridge Induction cooking zones (1 and 2) to be operated with 'a'
4. Extraction module
5. Bridge Induction Cooking zone 18 x 22 cm / max. 2.3 kW / max. 3.5 kW (boost) to be operated with 'd'
6. Bridge Induction Cooking zone 18 x 22 cm / max. 2.3 kW / max. 3.5 kW (boost) to be operated with 'c'
7. Connected Bridge Induction cooking zones (5 and 6) to be operated with 'c'
8. Control panel (visible only when the hob is turned on)

⚠ INFORMATION!

The maximum power output is depending on the type of cookware used and the thermal condition of the appliance.

Your hob with integrated extractor



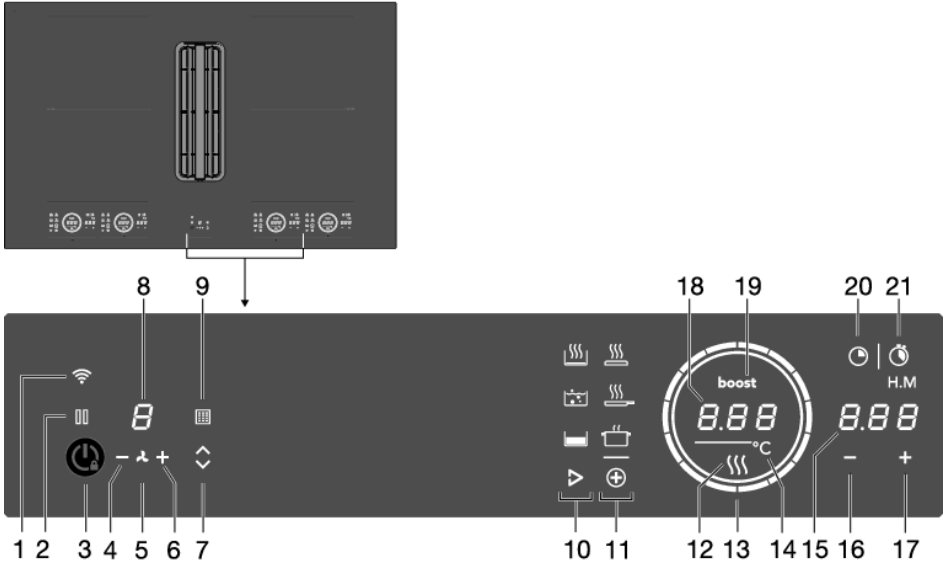

Control panel



1. Wi-Fi/connectivity touch key
2. Pause touch key
3. On/Off and Child lock touch key
4. - (minus) touch key for less extraction
5. Extraction on/off indication
6. + (plus) touch key for more extraction
7. Tower up/down touch key
8. Display extraction level
9. Filter indicator to clean grease filters or replace recirculation filter / Touch key to reset filter indicator
10. Touch key to start Celsius°Cooking™ programs (present depending on the appliance type)
11. Touch key to start PLUS programs
12. Residual Heat indication
13. Slide control (12 settings) / Hob standby indication
14. Degrees Celsius indication for Celsius°Cooking™ and PLUS programs.
15. Display time function
16. Time setting - (minus) touch key
17. Time setting + (plus) touch key
18. Display cooking settings / Text display
19. Boost indicator
20. Count-down timer touch key
21. Touch key for display cooking time - stopwatch

Your hob with integrated extractor

Explanation of the touch keys function









Touch key/slider	Description (see chapter 'Operation')
 On/Off	<p>Switching the hob on/off</p> <p>The appliance can be switched on and off with the on/off key. Depending on the 'Synchro Stop' setting, only the hob part or also the extraction module is switched off.</p> <ul style="list-style-type: none">• Synchro Stop switched on (by default): the appliance (hob part and extraction module) are switched off.• Synchro Stop switched off: only the hob part will switch off. Switch off the extraction module by setting the extraction level to '0' (or by activating Air-Dry mode). <p>Child lock</p> <p>The cooking zones can be locked and unlocked to prevent them from being switched on inadvertently. Touch the on/off key for approximately 3 seconds.</p>
 Slide control (12 settings)	<p>Slider inner circle</p> <ul style="list-style-type: none">• Hob switched on indication.• If the hob is switched off and at least one of the cooking zones is still hot, the inner circle remains illuminated. When the temperature of the hob drops below 65 °C, the inner circle also goes out. <p>Slider outer circle</p> <ul style="list-style-type: none">• Setting cooking zone power levels.• Setting temperature for Celsius°Cooking™ and PLUS function.
 Pause	<p>Pause</p> <p>The pause function can be used to pause the operation of the entire cooking hob for up to 10 minutes. This gives you time to safely clean the cooking hob without losing your settings.</p>
 Wi-Fi	<p>Wi-Fi</p> <p>The cooking hob is equipped with a Wi-Fi module that allows the appliance to connect to a mobile device such as a smartphone or tablet. It offers to monitor the cooking hob status via the mobile device. It is not possible to remotely control, turn on, or turn off the cooking hob for safety reasons.</p> <p>The monitoring function via mobile device shall not be used to directly replace the cooking process personal supervision on the cooking hob.</p>
 Count-down timer	<p>Count-down timer</p> <p>The count-down timer makes the cooking process easier by setting the cooking time for the selected cooking zone. When the time set on the timer expires, the cooking zone will automatically switch off and emit an acoustic signal. You can switch off the acoustic signal by touching the count-down timer key; alternatively, it will switch off automatically after a while. You can set the count-down timer independently for all cooking zones.</p>

Your hob with integrated extractor

Table continued from last page

Touch key/slider	Description (see chapter 'Operation')
 Stopwatch	Cooking time display - stopwatch The stopwatch can be used to see how long you have been continuously cooking on the selected cooking zone and starts counting automatically in the background.

Program function explanation

Program	Description (see chapter 'Operation')
 Celsius°Cooking™ Only visible as a Celsius°Cooking™ pan or probe is detected.	 Heating up and frying This program is to reach high temperatures rapidly. High pan bottom temperatures can be reached. Always add oil or butter before starting it. For healthy cooking don't exceed the smoke point of the used oil.
	 Boiling/cooking with water With this program, the water gets to boil quickly. Always add water before starting.
	 Slow cooking or sous vide This program is to control low to medium temperatures, preventing high bottom temperatures. Larger quantities and thicker dishes need to be stirred occasionally to ensure a homogeneous heat distribution.
 PLUS (Automatic cooking programs)	 Grill This function is exclusively for Bridge Induction cooking zones, that are linked to create one larger cooking zone. Grilling is optimized for ASKO induction accessories grill plate and teppanyaki. But it will also work with different cookware, but perhaps less accurate.
	 Frying/wok With this function, you can cook vegetables, fish, bacon, meat, fried potatoes, or eggs in butter or oil.
	 Heating up/keeping warm With this function you can, for example, melt chocolate (45 °C), keep food warm (70 °C), simmer (94 °C) or bring it to boil (100 °C).

Hob recall function

This feature allows you to recall all the settings of the cooking zones if the hob was accidentally switched off.



Within 6 seconds, the hob must be switched back on. Pressing anywhere on the slider within 6 seconds recalls all the settings from before the last switching off of the appliance.

Pan move function

If you remove the pan from an active cooking zone and within 6 seconds place it on a different cooking zone, you can transfer all the timer and cooking-related settings to the new cooking zone by touching the slider of the new cooking zone. To indicate this possibility, the new cooking zone displays copied settings on the slider. When the confirmation is done, the previous cooking zone is deactivated.

Your hob with integrated extractor

Indications on the display

In display	Status
—	Power level '0' for a cooking zone.
12	Power level that is set for a cooking zone; 1 = low / 12 = high.
boost	Boost function active.
L	The locking function is activated; the control panel is locked.
⋈	Residual heat indicator: The hob has a residual heat indicator for each cooking zone to show which cooking zones are hot after the cooking zone is turned off. Although the hob is switched off, the indicator will remain on as long as the cooking zone is hot! Avoid touching those cooking zones when this indicator is lit. ⚠ HOT SURFACE! Danger! Risk of burns.
E	Error code; See chapter ' <i>Troubleshooting</i> '.
— °C	Degrees Celsius indication for Celsius°Cooking™ and PLUS programs.
	Filter indicator (and touch key) for cleaning the grease filters or replacing the recirculation filter. Touch the key for 2 seconds to reset the filter indicator.
	Extraction indication <ul style="list-style-type: none">Steady light: extraction is on.When dimmed: extraction is disabled or in Air-Dry mode, or Synchro Control is enabled (automatic extraction).

Induction cooking



Induction cooking is fast

To start with, you will be surprised by the speed of induction cooking. Especially at higher settings, foods and liquids will come to a boil very rapidly. It is best not to leave pans unattended to avoid them boiling over or boiling dry. With induction cooking, there is no heat loss, and the handles stay cool.

The power level adjusts itself

In induction cooking, only the zone on which the pan is placed is used. If you use a small pan on a large zone, the zone will adjust the power to the pan's diameter. The power will thus be lower, and it will take longer before the food comes to a boil.

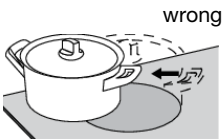
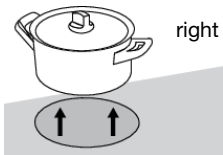

💡 INFORMATION!

- Grains of sand may cause scratches that you cannot remove. Therefore, only put pans with a clean base on the cooking surface and always pick pans up to move them.
- Do not use the hob as a worktop.
- Always keep the lid on the pan when cooking, in order to avoid energy loss.

Operation of the touch keys and sliders

- The touch controls may take some getting used to if you are used to other (rotary) controls. Place the tip of your finger flat on the control to achieve the best results.
- The touch sensors only react to the light pressure of a fingertip. Do not operate the controls with any other objects.
- The cooking hob is operated by a slider. You can either touch the selected part of the slider or slide in a circular motion clockwise to increase or anti-clockwise to decrease the power level and temperature.
- To set the cooking zone power level, touch the desired spot on the slider. As you touch the slider, the selected power level will appear on the cooking zone display unit.
- The selected part of the slider will be fully lit.
- Do not use any objects to operate the slider.

How induction works

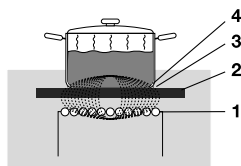

The coil (1) in the hob (2) generates a magnetic field (3). By placing a pan with an iron base (4) on the coil, a current is induced in the base of the pan.

Easy

The electronic controls are accurate and easy to set. On the lowest setting, you can melt chocolate directly in the pan, for example, or cook ingredients that you would normally heat in au bain-marie.

Fast

Thanks to the induction hob high power levels, bringing food to a boil is very quick.

Clean

The hob is easy to clean. Because the cooking zones do not get any hotter than the pans themselves, food spills are unlikely to burn into the glass.

Safe

The heat is generated in the pan itself. The glass top does not get any hotter than the pan. This means that the cooking zone is considerably cooler than a ceramic hob, for example.

Once a pan has been removed, the cooking zone cools down quickly.

Capacity distribution of cooking zones

Depending on the hob model, the cooking zones can affect each other. When several cooking zones are switched on simultaneously, the available capacity is shared automatically between them.

When the maximum capacity of the combination of cooking levels is reached during setting, one or more zones are automatically reduced to the highest possible setting at that moment. This is indicated by the flashing of the relevant control element.

Induction sounds

- **Ticking sound**

This sound can be caused at lower power level settings or by the automatic pot detection.

- **Pan makes sounds**

Pans can make some noise during cooking. This is caused by the energy flowing from the hob to the pan. At high settings, this is perfectly normal for some pans. It will not damage either the pans or the hob.

- **Ventilator makes sounds**

To increase the lifespan and performance of the electronics, the appliance is equipped with fans. During intense appliance use, the fan is activated to cool down the appliance, and you will hear a buzzing sound. The fan still runs for several minutes after the hob has been switched off.

Pans for induction cooking

Induction cooking requires a particular type of pan in terms of quality.

Pans that have already been used for cooking on a gas hob are no longer suitable for use on an induction hob.

Only use pans that are suitable for electric and induction cooking with:

- a thick base of a minimum of 2.25 mm;
- a flat base.

TIP!

You can check for yourself whether your pans are suitable using a magnet. A pan is suitable if the base of the pan is sufficiently attracted by the magnet.

Suitable	Unsuitable
Special stainless steel pans	Earthenware
Class Induction	Stainless steel
Solid enamelled pans	Porcelain
Enamelled cast-iron pans	Copper
	Plastic
	Aluminium

 **WARNING!****Be careful with enamelled sheet-steel pans:**

- the enamel may chip (the enamel comes loose from the steel) if you switch the hob on at a high setting when the pan is (too) dry;
- the base of the pan may warp - for example: Due to overheating;
- heat enamelled pans slowly.

Never use pans with a misshapen base. A hollow or rounded base can interfere with the operation of the overheating protection, causing the appliance to become too hot. This may lead to the glass top cracking and the pan base melting. Damage caused by using unsuitable pans or boiling dry is excluded from the guarantee.

Pan diameter

The diameter of the bottom of the pan must be at least 12 cm. You will achieve the best results by using a pan with the same diameter as the cooking zone. If a pan is too small, the zone will not work.

Pressure cookers

Induction cooking is very suitable for pressure cookers. The fast-reacting cooking zone brings the pressure cooker to pressure quickly. As soon as you switch off a cooking zone, the dish stops cooking immediately.

Pan detection

The cooking zone automatically detects a suitable pan placed on a cooking zone. The cooking zone display lights up.

Integrated pan recognition

If a certain power level is set for a cooking zone and there is no (suitable) pan on the cooking zone, the cooking zone will not deliver any power. After a certain period, the cooking zone will switch off automatically.

Grill plates

The hob has a Grill function (depending on the model) for using a grill plate. The function keeps the grill plate at an ideal temperature for grilling.

Cooking settings

Because the settings depend on the quantity and composition of the pan and its contents, the table below is intended as a guideline only.

Level	Purpose
Use settings 1 - 5 to:	<ul style="list-style-type: none">• simmer bouillon,• stew meats,• simmer vegetables,• melt chocolate,• poach,• melt cheese.
Use settings 6 - 9 to:	<ul style="list-style-type: none">• complete the cooking of large quantities,• defrost hard vegetables,• fry thick slices of breaded meat.
Use settings 10 - 11 to:	<ul style="list-style-type: none">• fry thick pancakes,• fry bacon (fat),• cook raw potatoes,• make breaded fish,• cook through fish,• fry thin slices of breaded meat.
Use setting 12 to:	<ul style="list-style-type: none">• sear meats,• cook fish,• cook omelettes,• fry boiled potatoes,• deep fry foods.
Use setting boost to:	<ul style="list-style-type: none">• bring liquids to a boil quickly,• shrink greens,• heat oil and fat,• wok.

Using the extraction module

The extraction module is equipped with a movable tower. Using the tower in the raised position, the extraction module will catch vapour more effectively, especially when using tall pans.

- The tower has two positions; lowered and raised. The position can be changed by touching the tower up/down key. By default, the tower rises automatically when the induction hob is operated. This can be changed in the '*Settings*' menu.
- Change the extraction setting with the - (minus) and + (plus) keys for the fan (1-4 and boost).

Setting the extraction level to '0' will manually switch off the extraction module or activate the Air-Dry function if necessary. Use Synchro Stop to automatically switch off the extraction module upon switching off the hob.

When the tower up/down key is touched during movement, the direction of movement is immediately changed. Also, if upward movement is obstructed (by an object for example) the direction of movement changes.

WARNING!

Make sure no objects obstruct the tower in its movement. Any object that is lifted or tilted may damage the hob and create a hazard (for example, spilling hot contents).

NOTE!

Disable setting 'Automatic raising of the tower' if it is undesirable for the tower to rise automatically when the extraction is switched on. See chapter '*Settings*'.

If the hob is switched off (manually or automatically) while the tower is in the raised position, the tower automatically lowers.

Automatic extraction

The extraction module has three automatic extraction settings (see chapter '*Settings*'):

- **Synchro Control:** Extraction is automatically controlled when a cooking zone is operated (the higher the power level of the cooking zone, the higher the extraction). Synchro Control overrides Synchro Start.
- **Synchro Start:** Extraction switches on at a fixed setting when a cooking zone is operated. Set the fixed setting via the settings menu.
- **Synchro Stop:** The extraction module is automatically switched off and is set to the Air-Dry function if necessary upon switching off the hob.

Placing pans and lids

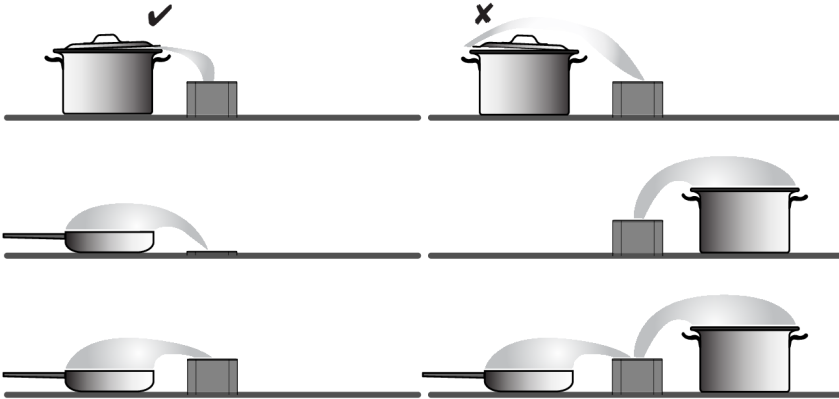
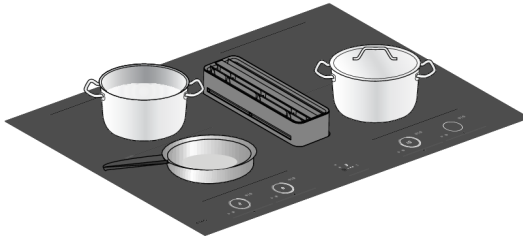

We recommend placing pans as close to the tower as possible, within the dimensions of the cooking zones. If a lid is used, place it at an angle on the pan with the opening towards the tower. This ensures optimal extraction.

TIP!

The use of lids has advantages:

- The heat remains in the pan so that the contents reach the desired temperature faster. The energy consumption is consequently lower.
- Most cooking vapours condense on the lid, allowing for less (moist) air extraction. With recirculation, humidity levels increase significantly less as a result. In addition, the exhaust module could run at a lower noise level.

Use the tower in the raised position for greater effectiveness, especially when using tall pans.

Air-Dry function

The Air-Dry function ensures that the extraction channels and grease filters are blown dry. After 10 minutes, the Air-Dry function switches off automatically.

Clean grease filter indicator

The extraction module has a filter indicator. This indicator flashes when the grease filters need to be cleaned. Three use intensities can be set, which determine the cleaning interval of the grease filters. By selecting the correct intensity of use based on cooking habits, the filters will not need to be cleaned more than necessary.

See the table for the required grease filter cleaning interval.

Indication	Intensity of use	Filter cleaning after (hour):
L1	Cooking and frying with little use of greases and oils.	40
L2 (default)	Cooking and frying with moderate use of greases and oils.	20
L3	Cooking and frying with lots of use of greases and oils.	10
off	Manual: The filters can be cleaned at any time (before signalled by the filter indication). The filter indication can then be reset. Note! Always reset the filter indicator after cleaning the filters. In the 'off' setting, the filter indicator appears only if you have not cleaned the filters for a long time.	40

Replace recirculation filter indicator

The extraction module has a filter indicator. This indicator and the letter 'r' on the display flash when the recirculation filter needs to be replaced.

The recirculation filter has a replacement interval of 300 operating hours. See 'Replacing the recirculation filter' in chapter '*Maintenance*'.

Operation

Start Preparing

Three cooking modes are available:

1. Standard cooking with power levels.
2. Cooking with the PLUS menu.
3. Cooking with Celsius°Cooking™ by measuring cookware temperature (available depending on the model)

Standard cooking

1. Place a pan on a cooking zone.
2. Touch the on/off key to switch on the hob.

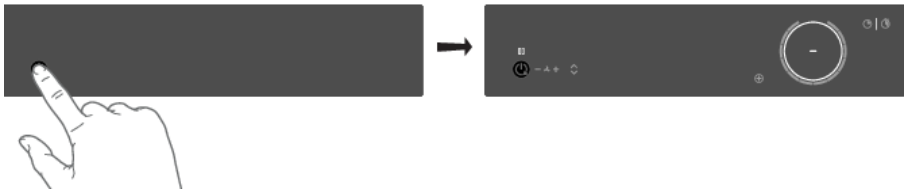

- A single audio signal sounds.
- The inner rings will light up.
- All the sliders light up; then they gradually go out. The slider only remains lit for the selected cooking zones on which you have placed a pan.

3. Slide with your finger over the slide control (clockwise) or tap with your finger on the slide control to set the desired setting.

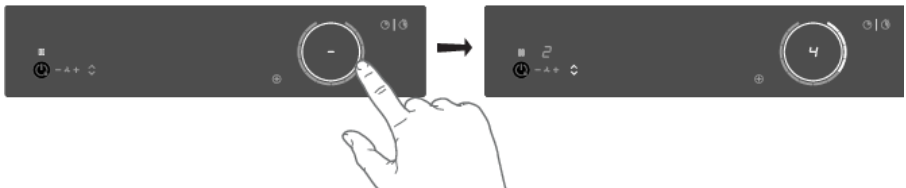

- The cooking zone starts automatically at the setting that has been set.

⚠ WARNING!

Depending on the settings, the tower can move up and down automatically.

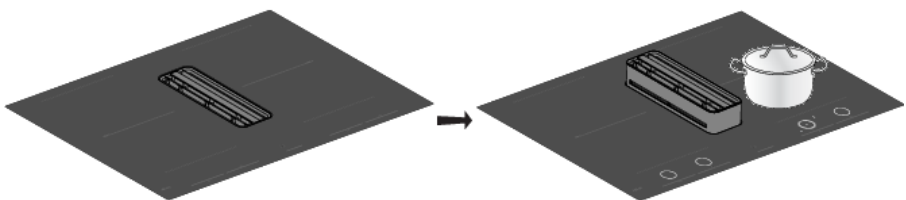

4. Set a higher or lower setting by sliding over the slide control with your finger or by tapping on the slide control.
 - *The cooking zones have 12 settings. There is also a 'boost' setting.*
5. Remove the pan or touch the slider for 3 seconds to switch the cooking zone off.

NOTE!

When no cooking zone is active for 60 seconds, the cooking hob will power off.

Boost

You can use the 'boost' function for cooking at the highest power level during a short time (max. 10 minutes). After the maximum boost time has passed, the power will be reduced to setting 12.

1. Place a pan on a cooking zone.
2. Touch level 12 of the slider or slide along level 12 to set the boost level. Touch level 12 twice if 'Auto Boost' is off (refer to chapter 'Settings').

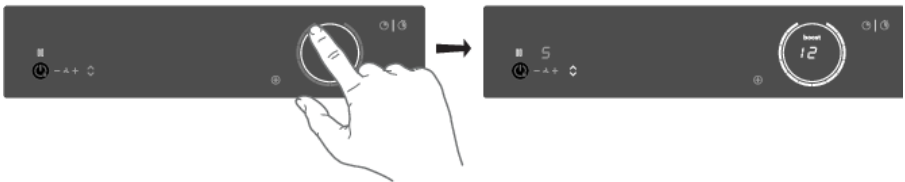

- *'12' and 'boost' appear in the display.*
- *If 'Auto Boost' is active, boost is automatically activated when power level 12 is selected (consult chapter 'Settings').*

3. To deactivate the boost for the selected cooking zone, again touch level 12 on the slider.

NOTE!

To avoid overheating, the electronic control system may automatically deactivate boost prematurely and decrease the power level to 12.

If there is no suitable pan on the cooking zone, the set level of temperature will flash. After one minute, the cooking zone will be switched off.

Operation

⊕ Cooking with the PLUS menu

The PLUS menu allows cooking with semi-automatic programs, enabling temperature cooking for all kinds of cookware that fit the program's purpose.

1. Touch the PLUS menu key to display the program line: keeping warm/heating up, frying/wok, and grill.
 - *When selecting the Grill program, you must use a grill plate that covers two linked cooking zones.*

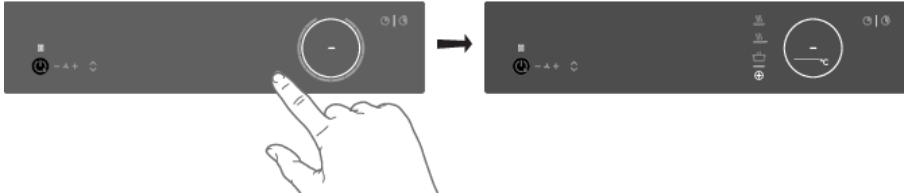

2. Select the desired program and temperature range by touching the relevant symbol. You can also toggle through the menu or temperature by long-pressing the relating touch key.

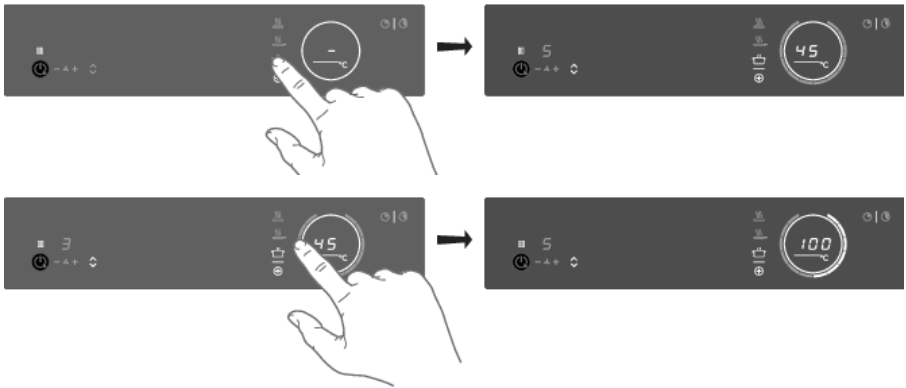

When the program or temperature selection does not change for 3 seconds, the program is activated. To deactivate a PLUS program, press the active program key for about three seconds or select a power level manually.

NOTE!

Always add water, oil or butter before starting a program; do not use an empty pan or pot.

Keeping warm and Heating up

Temperature (°C)	Use
45	melt chocolate
70	heating up/keeping warm
94	simmer vegetables
100	bring food or liquid to the boil quickly

Frying/wok

Temperature (°C)	Use
140 / 160	fish, bacon, fried egg, vegetables in butter
180 / 200	schnitzel, sausages, jacket potatoes
220	wok

Grill

This function is exclusively for connected Bridge Induction cooking zones that are combined to form a larger cooking zone.

Grilling is optimized for ASKO induction accessories: the grill plate and the teppanyaki. It will also work with different cookware, but perhaps less accurate.

Some functions are indicating the heat up time, counting down. In the heating-up stage, the slider and the set temperature will flash. When the set temperature is reached, a short beep will be emitted, and the slider will be constantly lit. You may then start cooking.

The sensor which measures the temperature while cooking within the PLUS menu programs is located in the glass below the cookware. Because of this, there is always an offset between the setpoint and the actual temperature of the content inside the cookware. The temperature of the content inside the cookware is therefore also dependent on factors such as the type of pan, the volume of liquid and whether a lid is placed on the pan.

NOTE!

Up to a temperature of 94 °C, the programs allow the hob to reach and maintain the set temperature automatically by measuring the glass surface temperature. This will avoid liquids overflowing and burning on the bottom of the pan.

NOTE!

From 100 °C on these programs will heat cookware with different timed power steps. The set temperature serves as an indication of the approximately to be reached temperature range. Someone must always be present to supervise the cooking process.

NOTE!

For more accuracy, Celsius°Cooking™ cookware such as Frying Pan, Chef's Pot or the Probe is recommended, with separate functions for it (see chapter 'Cooking with Celsius°Cooking™').

Operation

NOTE!

Starting these menu functions at the beginning of the cooking process will give the best results. An already hot surface will influence the performance.

Cooking with Celsius°Cooking™

Introduction

Welcome to Celsius°Cooking™.

The Celsius°Cooking™ programs have been developed in cooperation with Hestan Cue. Your new induction hob is fully packed with smart functions and features that make cooking easier and more pleasant.

In order to get the most out of these and explore what's possible with Celsius°Cooking™, you can also buy some additional connected equipment that will help you gain total control over temperatures and timings.

Additional accessories are included with some models.

This equipment lets you unlock the full power of Celsius°Cooking™, reading and communicating exact information about the temperature of your ingredients, giving perfect results. The equipment is:



Probe



Frying pan



Chef's pot

Find out more at www.celsiuscooking.com, www.asko.com.

► Cooking with Celsius°Cooking™ cookware and programs

This option involves cooking using either the Celsius°Cooking™ cookware (frying pan or pot's) that continuously measures the temperature inside the cookware or the Celsius°Cooking™ temperature probe. All use Bluetooth connections to send information about the temperature to the cooking hob.

Preparing the system

Before you start cooking, please make sure you complete all the preparation steps. Otherwise, you may run into difficulties or inadvertently cause damage to the system.

Using Celsius°Cooking™ ensures the cookware is always at the right temperature needed to prepare the food you are cooking.

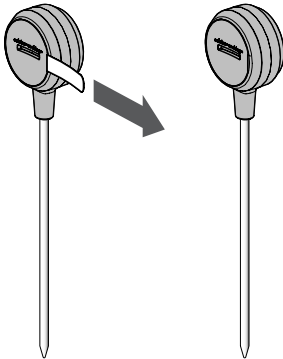

Prepare Celsius°Cooking™ Probe

1. Pull the battery protection tab out of the Celsius°Cooking™ Probe housing.
2. The Celsius°Cooking™ Probe is ready to be used. If necessary, replace the battery.

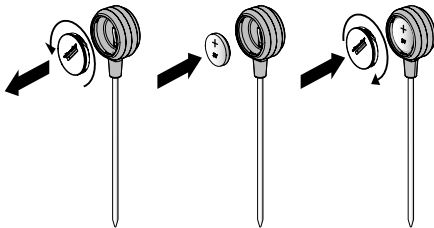

Battery installation Celsius°Cooking™ Probe

1. Unscrew and remove the battery cover and replace the battery (negative (-) side goes in first).
2. Replace the battery cover. Do not overtighten.

Insert the Celsius°Cooking™ Probe into a cooking pan

The Celsius°Cooking™ Probe can be used with different types and sizes of pans. Due to the use of a suspension bracket with different holes, the Probe can be suspended in different ways.

Operation

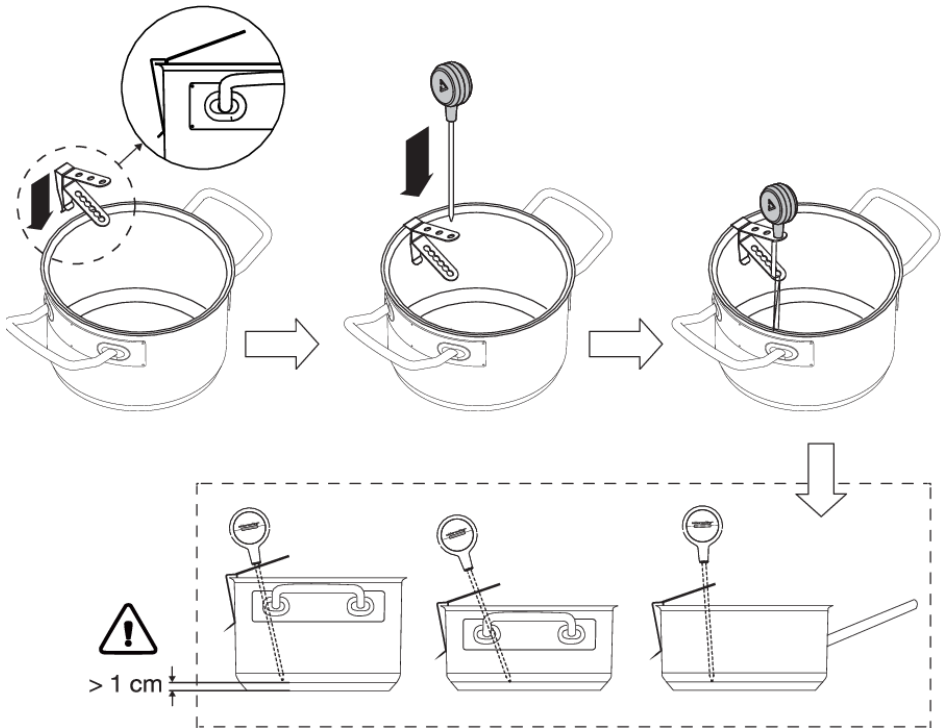

1. Slide the suspension bracket over the pan edge.
2. Insert the probe into the suspension bracket from above.

NOTE!

- Leave a minimum distance of 1 cm between the pan base and the measuring point of the probe!
- In case the connectivity between cookware and the hob is unstable, this could be due to a low battery. In those cases, we recommend changing the battery.

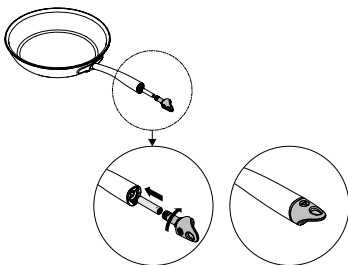

Celsius°Cooking™ Cookware

1. Insert an AAA battery in the panhandle (negative (-) end goes in first).
2. Insert the handle end into the panhandle and turn it a quarter to secure.

NOTE!

Do not exchange the handle cap of a chef's pot (31620) with that of a frying pan (31619) or vice versa.

Assigning the cookware to the cooking zone

Switch on the hob and wait until the end of the start-up animation.

Place the Celsius°Cooking™ cookware or a regular pan fitted with the Celsius°Cooking™ probe on the desired cooking zone. After it has been detected, quickly tap twice with your fingertip on the sensor in the end cap or the probe housing to activate it. Then the Celsius°Cooking™ mode key will immediately light up. To assign the probe, the Celsius°Cooking™ mode key will light upon every possible cooking zone. Press the Celsius°Cooking™ mode key of the desired cooking zone. The Celsius°Cooking™ menu will be opened. With a short press again, it can be closed.

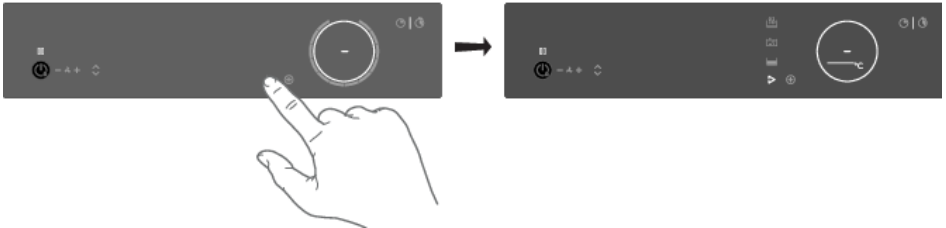

Cooking with the embedded Celsius°Cooking™ programs

The hob comes along with integrated Celsius°Cooking™ programs, optimized for Celsius°Cooking™ cookware. With the opened menu, 3 different cooking methods can be chosen, with different temperature ranges. If the probe is used, only two suitable Celsius°Cooking™ methods are shown. Use the one that fits the desired purpose:

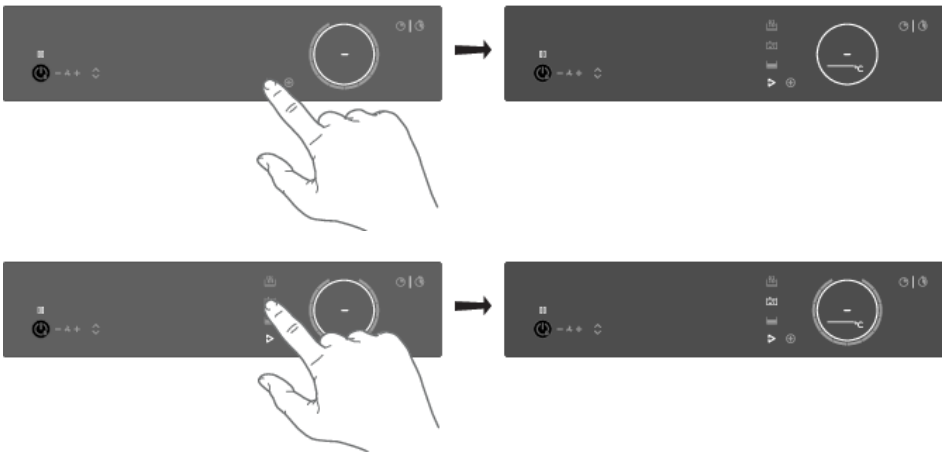

Operation

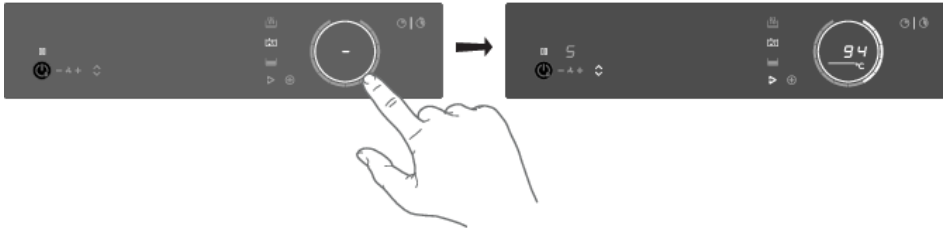

Heating up and frying

This program is to reach high temperatures rapidly. High pan bottom temperatures can be reached. Always add oil or butter before starting it. For healthy cooking don't exceed the smoke point of the used oil.

Boiling or cooking with water

With this program, the water gets to boil quickly. Always add water before starting.

Slow cooking or sous vide

This program is to control low to medium temperatures, preventing high bottom temperatures. Larger quantities and thicker dishes need to be stirred occasionally to ensure a homogeneous heat distribution.

Using the probe as a cooking thermometer

When a Celsius°Cooking™ probe is used it can also be used as a thermometer to just monitor e.g. the core temperature of a certain dish. This can be done on normal level cooking or PLUS menu programs. To use the probe as thermometer, lift up the pan you want to use for a few seconds, place it back on the zone and activate the probe by tapping. When the Celsius°Cooking™ symbol appears on the display, touch it.

INFORMATION!

Please make sure that the appliance is already switched on before placing the Celsius°Cooking™ cookware so that the system can clearly identify its position.

TIP!

When the Celsius°Cooking™ Probe is recognized on a cooking zone, it can also be used as a thermometer. The display then shows the temperature instead of the power level. As the power level changes, it is temporarily displayed in place of the actual temperature.

Probe removal detection

If the probe is moved out during cooking, the hob will detect that and stop heating. When placed back, the user can confirm that by touching the now blinking Celsius°Cooking™ mode button, or it might get re-detected automatically.

E.g. adding cold water to the pot might trigger this detection too!

Step-by-Step cooking guide on CelsiusCooking.com



The best-tasting food is prepared at the right temperature and for the right length of time. The ability to set temperature instead of power levels supported by how-to (video) guidance lets you create chef-like meals cooked to perfection. The CelsiusCooking.Com website is full of inspiring recipes with step-by-step instructions based on chef-tested techniques guiding you to prepare deliciously, fail-proof recipes over and over again.

CelsiusCooking.com

- Whether you are a chef or a beginner, CelsiusCooking.com is going to help you cook better food more often by acting as your guide in the kitchen. You'll learn new techniques, novel combinations, and gain confidence in more difficult dishes. Instead of just cooking at a power level, you will be cooking at an exact temperature level.
- Our recipes lead you through the process of 'Mise en place' where you'll gather and prepare all of your ingredients in advance. This is particularly important following the recipes on CelsiusCooking.com as each recipe has been carefully timed to give you the perfect results.
- Just follow the steps. The timing and temperature guide will make sure your food is prepared to perfection. It may take some getting used to, but you will end up with an even better meal.

Switching off the cooking zone

Switching off a Celsius°Cooking™ controlled zone is possible by setting the temperature to zero (0). The display will show a dash. Alternatively, touch the Slider or the Celsius°Cooking™ key from the zone to be switched off for at least 3 seconds to deactivate the Celsius°Cooking™ mode completely.

💡 INFORMATION!

While the Celsius°Cooking™ probe is used to control the temperature of the content inside a pan (e.g. water or soup) the Celsius°Cooking™ cookware is controlled on the pan bottom temperature. Due to this, there is always an offset between the set-point and actual temperature of the content INSIDE the cookware. When, e.g. trying to boil a liquid on the Celsius°Cooking™ cookware may be necessary to set a higher temperature to reach the boiling point. Reaching the boiling point is also further dependent on the volume of the liquid and whether a lid is placed on top of the cookware. Furthermore, regular stirring improves this behaviour, even when cooking with the probe.

Bridge Induction zone

The Bridge Induction zones can be linked together. This creates one large zone that can be used, for example, for a large fish pan or various pans at the same power.

- Pan position recognition is activated automatically after the appliance is switched on. When a pan is placed on the hob, the pan recognition function recognizes its position and automatically bridges the cooking zones depending on the size of the pan (only if the hob was already switched on).
- If the Bridge Induction zones are linked, they cannot be set to boost and, the menu functions cannot be used.
- Use a fish pan or other pan covering at least one of the Bridge Induction zones in the middle.

Operation

Connecting Bridge Induction zones

1. Place a large pan on both cooking zones so that both zones are well covered.
 - If the **brd** (auto-connecting) function is active, the zones are linked automatically (consult chapter 'Settings').
2. Touch the sliders of both left or both right cooking zones.

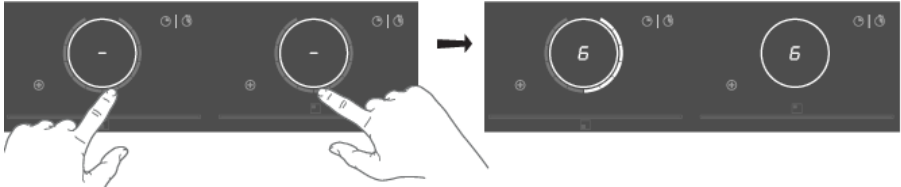

- The power level or temperatures are displayed simultaneously on both connected cooking zones.
3. Use the slider of the front cooking zone to set the desired cooking setting for the linked cooking zones.
 4. Touch both sliders again to unlink the cooking zones.

Pause

The pause function can be used to pause the operation of the entire cooking hob for up to 10 minutes. Thus, you can walk away from the appliance or safely clean the cooking hob, within a short period, without losing your settings.

Switching on the pause

At least one cooking zone must be active.

Touch the pause key.

- You will hear a short beep.
- The settings on all active hobs are reduced to level 2.



- All timer functions are paused.
- The pause key flashes.
- All keys are inactive except the pause and on/off-key.

If no key is touched within 10 minutes, all active hobs automatically turn off.

Celsius°Cooking™ programs are not paused since they are automatically operated.

Switching off the pause

Touch the pause key again within 10 minutes.

- *The hob continues to operate with the same settings.*

Child lock

The cooking zones can be locked to prevent them from being switched on inadvertently.

1. Touch the on/off key to switch on the hob.
2. Touch the on/off key for approximately 3 seconds.

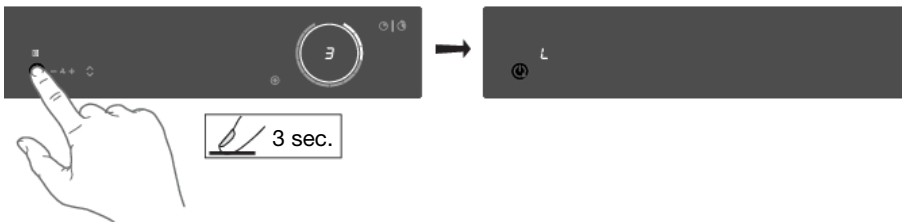

- *The indication 'L' appears on the display and the hob controls are locked.*
3. Proceed in the same way to unlock the controls.
 - *When touching and holding the on/off key, 'L' appears on the display and then disappears. The controls are unlocked.*

Time functions

Every cooking zone has two timers: a count-down timer and a stopwatch (count-up timer).



Count-down timer

The count-down timer makes the cooking process easier by setting the cooking time for the selected cooking zone. When the time set on the timer expires, the cooking zone will automatically switch off and emit an acoustic signal. You can switch off the acoustic signal by touching the count-down timer key; alternatively, it will switch off automatically after a while. You can set the count-down timer independently for all cooking zones.

Setting the count-down timer

1. Touch the count-down timer key for the desired active cooking zone.

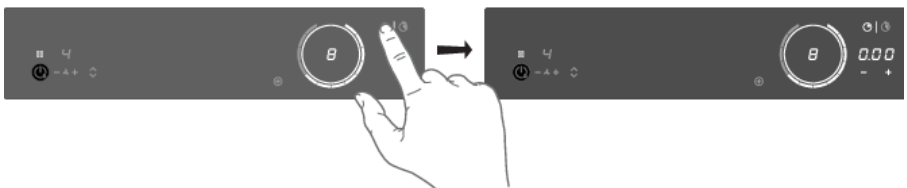

- *The count-down timer key and 000 will flash on the cooking zone display unit.*

Operation

- Set the desired cooking time with + (plus) and - (minus) touch keys.

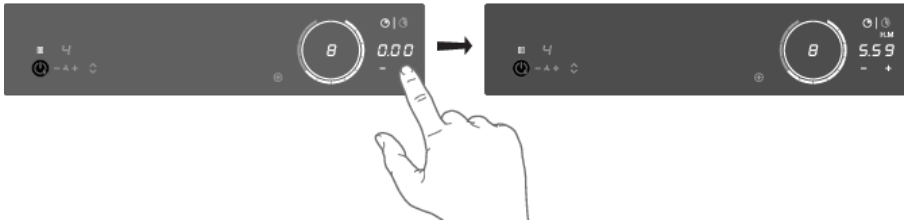

- Touch the - (minus) key to increase the time in hours. Touch the + (plus) key to increase the time in minutes. Then, if desired, touch the - (minus) key to decrease the time in minutes.
 - If the time is not set within five seconds, the count-down timer is disabled.
- If desired, repeat the same steps to set the count-down timer for another active cooking zone.
 - When a Celsius°Cooking™ program is active, the timer will start counting down when the program reaches the desired temperature.

TIP!

If you move the pan from the cooking zone, all timer functions set for that cooking zone will be paused.

Deactivating the count-down timer

Long touch the count-down timer key for the desired active cooking zone.

- The timer is switched off.
- Deactivating the count-down timer alarm.
- When the set time expires, alarm will be sounded, the key for the relevant cooking zone will flash, and 0:00 will flash on the count-down timer display unit.
- To acknowledge and stop the alarm, touch the count-down timer key, or remove the pan from the cooking zone.



Cooking time display – stopwatch

The stopwatch can be used to see how long you have been continuously cooking on the selected cooking zone and starts counting automatically in the background.

Touch the stopwatch key.

- The stopwatch time will be displayed on the cooking zone display unit.
- The stopwatch can be reset if you press the stopwatch key for 3 seconds.

Operating the extraction module

The extraction module is set to Synchro Control by default (see 'Automatic Extraction' in the 'Use' chapter). In Synchro Control, the extraction module keys/indicators are dimmed. The suction is adjusted according to the use of the cooking zones. Setting 5 (boost) is a temporary setting in Synchro Control too. The tower automatically rises when the extraction module becomes active (if the setting 'Automatic raising of the tower' is switched on).

NOTE!

Disable setting 'Automatic raising of the tower' if it is undesirable for the tower to rise automatically when the extraction is switched on. See chapter 'Settings'.

Setting the extraction level manually:

1. Touch the + (plus) key to start the extraction.
 - *Tower rises (if 'Automatic raising of the tower' is enabled).*



2. Use the + (plus) and - (minus) keys to set the desired extraction level.
 - *There are 4 extraction levels and a boost level (level 5) available.*
 - *Long touch the + (plus) touch key to directly select boost mode.*
 - *After 10 minutes, the boost level automatically switches back to setting 4.*

NOTE!

Simply touch the - (minus) or + (plus) touch key to override Synchro Control. When Synchro Control is overruled, simultaneously touch the - (minus) and + (plus) touch keys to set the extraction to automatic operation (Synchro Control).

Operation

Raising or lowering the tower manually:

Touch the tower up/down key.

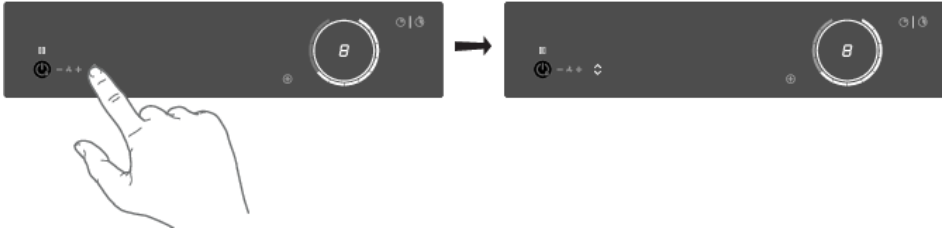

- The tower rises.
- Touching the up/down key again while the tower moves up/down reverses the direction of movement. If something stops the tower while it is moving up, the tower will move down again.

Air-Dry function

The Air-Dry function is automatically activated as soon as the extraction module is switched off. If the cooking area is already switched off, the Air-Dry function is automatically activated as soon as the extraction module is also switched off (by setting the extraction level to '0').

Touch the - (minus) key for 3 seconds to activate the Air-Dry function during cooking.

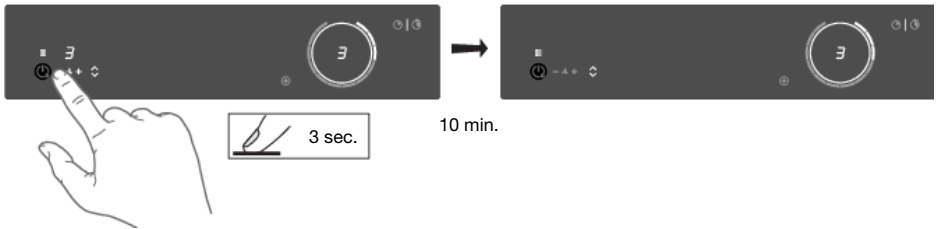

- The extraction indicator pulses (dimmed).
- Switch off the Air-Dry function at any time by touching the - (minus) key for 2 seconds.
- After 10 minutes, the Air-Dry function switches off automatically.



ConnectLife-app and Wi-Fi connection

The hob is equipped with a Wi-Fi module that allows the appliance to connect to the internet via your home network and to use it with the **ConnectLife**-app, installed on a mobile device like a smartphone or tablet.

The app is available on the Apple App Store and Google Play Store. You will need the app to connect the hob to your network. After your user account is paired with the cooking hob, the app can be used to monitor the status of the cooking hob and enables to update its firmware (see chapter '*ConnectLife and Wi-Fi*').

You can find direct links for the different stores to the ConnectLife-app under www.connectlife.io/getstarted and more information about the system, support, available functionalities, and additional options under www.connectlife.io.

For safety reasons, it is not possible to remotely control, turn on or turn off the hob.

Preparation

- Make sure you know the name/SSID of your router's Wi-Fi network and its password¹⁾.
- Make sure you have the label with the QR code of the appliance unique ID ('AUID') accessible – you need to scan it with your mobile device when the App prompts to do so.
- Your smart device's Bluetooth is turned on.



- Install the **ConnectLife**-app on a mobile device – scan the QR code to find it.
- Launch the App. Please register if you don't have an account yet.
- Log in with your account.
- The App will need access the mobile's location to search for Wi-Fi networks and to the camera to scan QR codes.

Wi-Fi Connection setup

You will first connect your mobile device directly to the appliance via Wi-Fi, and then use this connection to share the data of your Wi-Fi home network. The hob can then connect to the home network.

1. Launch the **ConnectLife**-app.
2. In the ConnectLife application, go to the "Add device" menu and select the appropriate type of device. Then scan the QR code (it can be found on the rating plate of the appliance; you can also enter the AUID/SN code manually).

Follow the instructions in the ConnectLife-app.

The user account signed in on the mobile device used for the Connection setup will automatically be paired with the cloud. If you'd like to pair another account, e.g. on a second user's mobile device see "Pairing additional user".

For safety reasons, only paired users can communicate with the hob.

¹⁾ NOTE: only 2,4 Ghz networks are supported

ConnectLife and Wi-Fi

Activate Wi-Fi

1. Switch off the hob.
2. Touch the on/off key for 5 seconds.
 - A short beep will be emitted. The Wi-Fi key will appear.

Wi-Fi menu

Activate Wi-Fi to enable the Wi-Fi menu. The hob must be switched on.

1. Touch the Wi-Fi key for 3 seconds to open the Wi-Fi menu.
 - Depending on the Wi-Fi state, there are 1 to 3 options available in the menu: **'C'** (connection) to set up a connection, **'P'** (pair) to pair an additional user, and **'U'** (unpair) to unpair all users.
2. Use the + (plus) and - (minus) keys to switch between them, if more than 1 option is available.
3. Touch the Wi-Fi key to confirm the selected option.
4. Touch the on/off key or touch the slider to close the menu.
 - If no key is pressed within 60 seconds, the menu will be switched off automatically.

Connection setup

1. Select option **'C'** in the Wi-Fi menu.
 - The appliance is in "Connection Setup Mode" for 5 minutes.
 - **'C'** will flash, and the + (plus) and - (minus) keys will be switched off.
2. On the mobile app, start the process to 'Add appliances' and follow the instructions to set up the network.

Pairing additional user

This option requires that the connection setup has been performed successfully and the hob is connected to the cloud (Wi-Fi key is constantly full lit).

1. Select option **'P'** in the Wi-Fi menu.
 - The appliance is in "Pairing Mode" for 3 minutes.
 - The Wi-Fi key will flash, and the + (plus) and - (minus) keys will be off.
2. On the mobile app, start the process to 'Add appliances' and follow the instructions to pair the appliance.

Unpair all users

This option requires that the connection setup has been performed successfully and the hob is connected to the cloud (Wi-Fi key is constantly full lit).

1. Select option **'U'** in the Wi-Fi menu to unpair all users and disconnect from the cloud.
 - The Wi-Fi key will flash 3 times.
 - The hob will delete all paired users and disconnects from the cloud ("unpair").

Switching off Wi-Fi

1. Enter the Wi-Fi menu as explained in 'Wi-Fi menu'.
2. Touch the Wi-Fi key for 3 seconds to deactivate Wi-Fi.
 - A short beep will be emitted. The Wi-Fi key will be off.

Firmware Update

The cooking hob is equipped with a Wi-Fi module that you could use to receive updates of the appliance firmware (for example, improved function updates or safety-relevant updates). This requires that the cooking hob is connected to the cloud and paired with a registered user account on the **ConnectLife**-app. If this is not yet established, consult chapter '*ConnectLife and Wi-Fi*'.

When new firmware is available, a notification is sent to the **ConnectLife**-app. Please follow the instructions.

To start the update process, the cooking hob needs to have the **FoA** setting set to **ON** in the settings menu (see '*Settings*'). This confirms your presence at the cooking hob. After 90 minutes, this setting is automatically reset to **OFF**.

After the **FoA** setting on the cooking hob is set to ON, start the update process on your **ConnectLife**-app. The cooking hob will switch OFF. As an indication, the Wi-Fi symbol flashes during the process. Depending on the configuration, the update process can take up to 60 minutes.

NOTE!

During the update process, you cannot use the hob. The hob will restart several times and will not respond for periods. Make sure that the power supply and the Wi-Fi connection are not interrupted during the update.

If the update fails, the hob will remain on the previous firmware version and operate as usual. Try again after a short period of time. If the update continues to fail, please get in touch with the service department for further assistance.

If the hob is not responding after updating, it may not have completed the update. Wait for the update process to complete. If the hob still does not respond after a while, please contact the service department for further assistance.

Settings

You can tailor the behaviour of this induction hob to suit your cooking style! There are various settings available for adjustment.

While there are no pans on any zone, touch any slider with two fingers and keep it touched for 3 seconds. Different settings can now be toggled through using the slider. To view or change a particular setting, touch the highlighted element of the slider with one finger and keep it touched for 3 seconds. Now you can choose to change or disable that setting. To do this, toggle to the desired value. After 3 seconds of inactivity, the new setting will be confirmed.

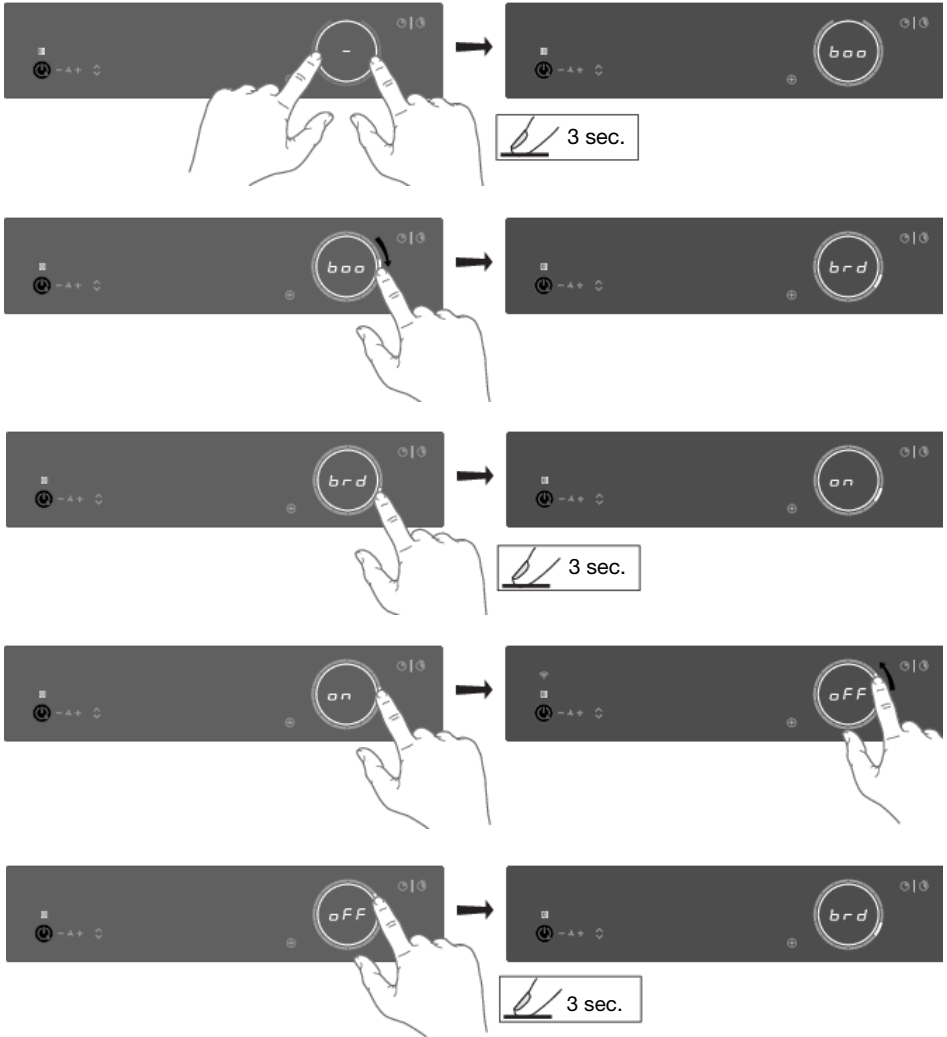

NOTE!

To prevent unintentional adjustment of the 'Con - connected power', Con setting must be confirmed when changed by touching the slider for 3 seconds. A change without confirmation will not be implemented!

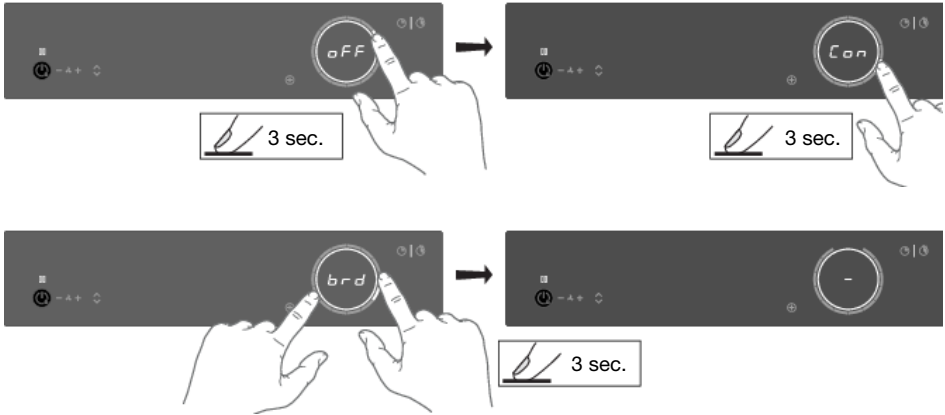

To exit the menu, touch with two fingers anywhere the slider for 3 seconds.

The following settings are available (depending on the model).

boo - Auto boost Automatic Boost activation	While on, boost is automatically activated when power level 12 is activated. While off, the boost is activated by sliding past the power level 12 or touching power level 12 twice.
brd - Auto bridge Automatic coupling	While on, when a new pan is detected on two connected Bridge Induction cooking zones, the cooking zones are automatically connected into one big cooking zone. While off, connecting must be done manually by pressing on the sliders of two Bridge Induction cooking zones at the same time.
rEC - Recovery function Recovery function	While on, the recovery function is active and, settings can be moved from one cooking zone to the other when a pan switches position.
Ati - Auto timer Automatic stopwatch timer	While on, the stopwatch (count-up timer) starts counting in the background whenever a cooking zone is activated. While off, the stopwatch must be activated manually and starts counting from 0:00.
ACL - Auto child lock Auto child lock	While on, the hob is automatically locked at every switch off.
Snd - Sound volume Sound volume	Sound volume has 4 different options. L3 (high), L2 (medium), L1 (low), off (only error and alarm sounds).
SEn - Key sensitiveness Key responsiveness	Key responsiveness has 3 different speed options. L3 (quick), L2 (medium), L1 (slow).

Settings

Table continued from last page

<p>hSt - Synchro Start (Synchro Start Level)</p>	<p>This setting allows the induction hob to automatically activate the suction of the extraction module every time the induction hob is turned on. Depending on the value you set, the suction will automatically start at that speed level when any cooking zone is activated.</p>
<p>hSc - Synchro Control Synchro Control response Level</p>	<p>This setting allows the induction hob to control the extraction module. The extraction module will automatically switch on when setting a cooking zone power. The cooking zone with the highest power setting determines the degree of extraction. Synchro Control can be overruled by using the + (plus) and - (minus) keys and it can be reactivated by touching the + (plus) and - (minus) keys simultaneously. The response sensitivity can be set: L3 (high), L2 (medium), L1 (low), off.</p>
<p>hSP - Synchro Stop Synchro Stop, switch off function extraction module</p>	<p>With this setting, when the appliance is switched off, the extraction module can also be switched off automatically and the Air-Dry function can be activated if necessary. If there are still hot pans on the hob, the Air-Dry function will start at a higher setting if essential until all cooking zones have cooled down. Then Air-Dry continues with the normal cycle of 10 minutes on extraction level 1.</p>
<p>Ato - Automatic raising of the tower Automatic raising of the tower</p>	<p>Disable this setting if it is undesirable for the tower to rise automatically when the extraction is switched on.</p>
<p>rCi - Recirculation filter Recirculation filter</p>	<p>Activate this setting if a recirculation filter is installed. There are 2 options available:</p> <p>off - (default)</p> <p>CAr - Recirculation filter</p>
<p>GrF - Clean grease filters indicator Clean grease filters indicator</p>	<p>Activate this setting if the filter cleaning indication is desired. There are 4 options available:</p> <p>off - Manually</p> <p>L1 - Cooking and frying small quantities</p> <p>L2 - Cooking and grilling medium quantities (standard)</p> <p>L3 - Frying, grilling, and wokong</p>
<p>btP - Bluetooth pairing Bluetooth device pairing</p>	<p>To pair a Bluetooth device, set this setting to on. You now have 3 minutes to pair a new Bluetooth device to this induction hob.</p>
<p>btC - Bluetooth clear Bluetooth clear paired devices</p>	<p>To unpair, all the Bluetooth devices set this setting to Clr. All your connected Bluetooth devices are now unpaired.</p>
<p>Fir - Display firmware version Firmware version</p>	<p>To display the current software versions of the hob. The UI software version and the Celsius°Cooking™ software version will be shown in alternating order.</p>

Table continued from last page

<p>FoA - Firmware update over the air Firmware update via Wi-Fi</p>	<p>To receive firmware updates for the cooking hob, you need to be paired to the cooking hob via the mobile app. You will receive a notification, or you can check available firmware updates on the mobile app menu for updates.</p> <p>In order to start the firmware update via the mobile app, set this setting to on to confirm your presence at the cooking hob. For more information, see chapter "<i>ConnectLife and Wi-Fi</i>". After 10 min, this setting is automatically reset to off.</p>
<p>Con - Connection power Current limiter (connection to power grid)</p>	<p>If your electrical wiring or circuit breakers do not meet the specified current draw on the rating plate, the current limiter can be activated by reducing the value of this setting. Doing so will cause a reduced performance of the induction hob.</p> <p>The following numbering format of the setting is available: X.XX. The number left of the dot represents the number of connected phases, while the number right of the dot represents the electrical current per phase in Ampere.</p> <p>NOTE!</p> <p>To prevent unintentional adjustment of the 'Con - connected power', Con setting must be confirmed when changed by touching the slider for 3 seconds. A change without confirmation will not be implemented!</p> <p>⚠ WARNING!</p> <p>The appliance must always be set to the actual or lower rating of the electrical wiring or circuit breakers. This setting can only be set by an authorised expert.</p>
<p>rES - Factory reset Factory reset</p>	<p>Resets to default settings.</p>
<p>dE - Demo mode Demo Mode for Dealer Showrooms</p>	<p>In demo mode, the appliance will act as usual, without the possibility to heat the cookware.</p> <p>When set, this will be indicated after switching on the appliance with a short "d" indication.</p> <p>Without any user interaction, the appliance will automatically switch off after 10 minutes.</p>

Maintenance

Cleaning glass top

TIP!

Activate the child lock before cleaning the hob.

Daily cleaning

- Although food spills cannot burn into the glass, we nevertheless recommend you clean the hob immediately after use.
- For daily cleaning, a damp cloth with a mild cleaning agent is best.
- Dry off with kitchen paper or a dry tea towel.

Stubborn stains

- Stubborn stains can also be removed with a mild cleaning agent, washing-up liquid, for example.
- Remove water circles and limescale with cleaning vinegar.
- Traces of metals (caused by sliding pans) can be difficult to remove. Special products are available for this.
- Use a glass scraper to remove food spills. Melted plastic and sugar are also best removed with a glass scraper.

NOTE!

- Never use abrasives. These leave scratches in which dirt and limescale can accumulate.
- Never use anything sharp such as steel wool or scourers.

Cleaning the extraction module

WARNING!

The extraction module must be cleaned regularly. Mind that the pins bearing the tower are cleaned after every use.

Do not use abrasive cleaning products. Do not use alcohol!

If the instructions regarding cleaning the appliance or replacing the filters are not followed, this can cause a fire. These instructions must be followed! The manufacturer is not liable for damage to the appliance or fire damage resulting from incompetent maintenance or from non-adherence to the safety instruction above.

Cleaning the tower

Remove the tower.

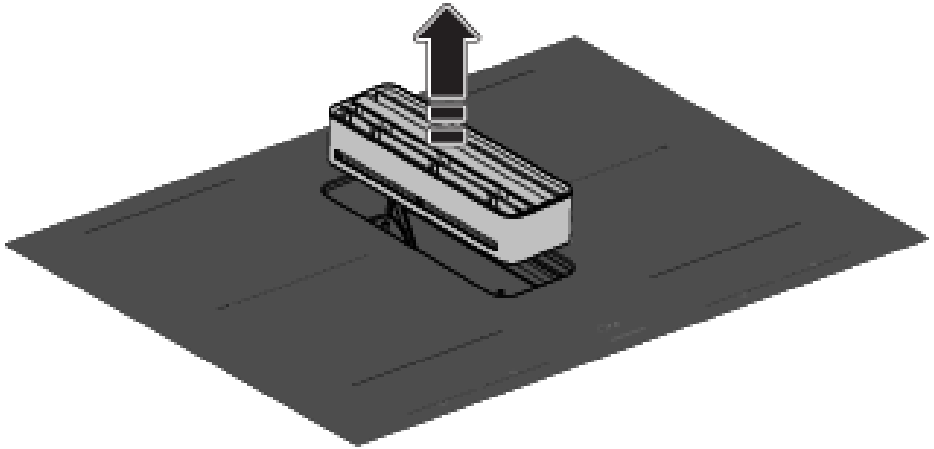

Rinse the tower daily under the tap with warm water. Clean the tower weekly with water and a little washing-up liquid. The tower can also be cleaned in the dishwasher.

The glass trim is not resistant to falls or bumps.

WARNING!

Replace the tower if the tower's glass trim is damaged. Sharp edges on the strip can cause injuries.

TIP!

The underside of the tower is marked with an arrow. The tower will be best aligned with the glass when the arrow is pointed backwards.

Cleaning grease filters

Remove the grease filters from the extraction module. The metal filters can be pushed out of their plastic frame if necessary.

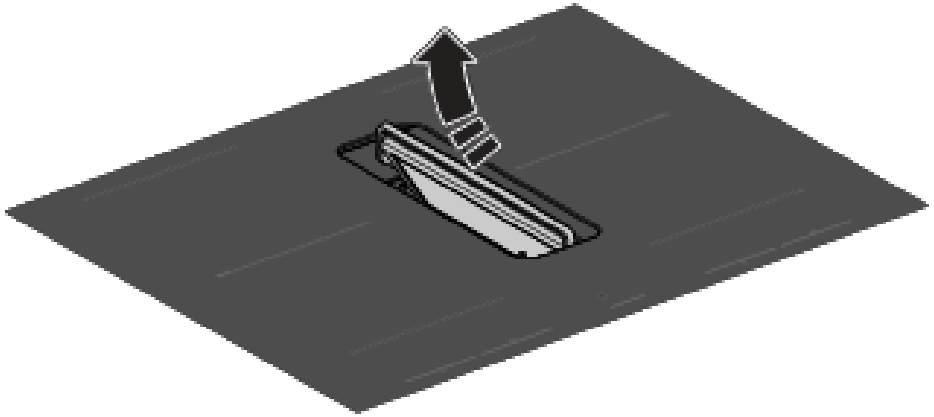

When indicated by the filter indicator, the metal filters must be cleaned by hand or in the dishwasher at low temperatures with a short program. Never put the plastic frames in the dishwasher separately, without metal grease filters. See chapter '*Settings*' for filter cleaning settings.

NOTE!

It is important that the grease filters are thoroughly dried before they are fitted again.

Cleaning the condensate reservoirs

It is recommended to check and empty the condensate reservoirs every two weeks.

1. Remove the condensate reservoirs from the exhaust inlet with the handles.
 - *Attention: remove the filters first before removing the condensate reservoirs.*

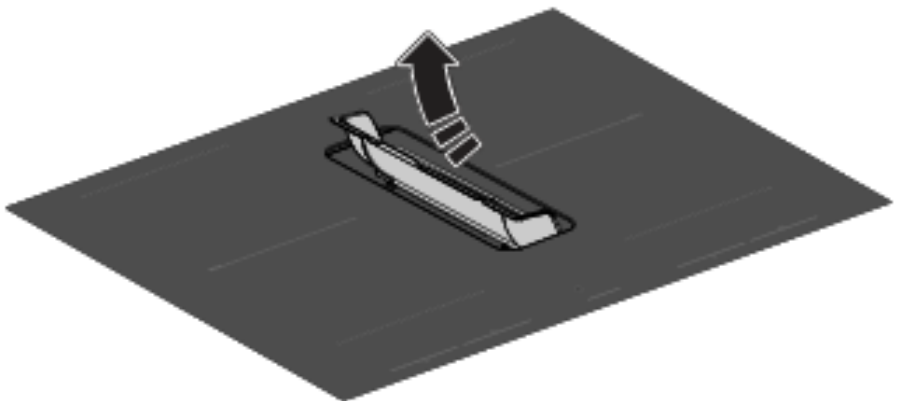

2. Empty the condensate reservoirs and clean them with warm water and a little washing-up liquid or in the dishwasher.
3. Clean the interior of the extraction module with a damp cloth.

Filter indication

Saturation of grease filter and recirculation filter

If only the filter indicator is flashing, the grease filters need to be cleaned. If both the filter indicator and the letter 'r' flash in the display, replace the recirculation filter.

Grease filter

After 10, 20, or 40 hours of operation, the grease filter indicator lights up (depending on the intensity of use).

- The grease filters should then be cleaned.
- Reset the filter indicator by touching the filter indicator key for 2 seconds.

Recirculation filter (if in recirculation mode)

After 300 operating hours (recirculation filter), the filter indicator and the letter 'r' flash on the display.

- Replace the recirculation filter.
- Reset the filter indicator by touching the filter indicator key for 2 seconds.

Replacing recirculation filter (when using the recirculation box)

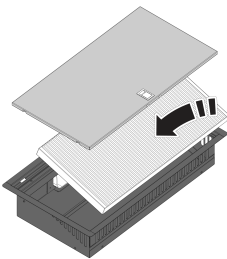

The recirculation box with a filter is located under the bottom of the cabinet and is accessible from the kitchen cabinet.

1. Open or remove the bottom drawer of the kitchen cabinet.
2. Remove the cover of the recirculation box.
3. Remove the filter.
4. Fit a new filter with the arrow (see on the side of the filter) pointing upwards.
5. Fit the cover of the recirculation box, and close the drawer or put it back in place.
6. Reset the filter indicator by touching the filter indicator key for 2 seconds.

TIP!

Consult the website for additional maintenance and cleaning instructions!

Troubleshooting

General

NOTE!

If you notice a crack in the glass top (however small), switch off the hob immediately and disconnect the power supply (remove the plug from the socket).

Then contact the Service Department.

Troubleshooting table

If your hob does not work properly, it does not always mean that it is defective. Make sure to check the points mentioned below in the table, or visit our website for more information.

Induction zones

Symptom	Possible cause	Solution
Characters appear in the displays when the appliance is connected for the first time.	This is the standard set-up routine.	Normal operation.
The fan runs on for several minutes after the hob has been switched off.	The hob is cooling down.	Normal operation.
A slight smell is noticeable the first few times the hob is used.	The new appliance is heating up.	This is normal and disappears after the hob has been used a few times. Ventilate the kitchen.
You can hear a ticking sound in your hob.	This is caused by the capacity limiter on the front and back zones. A soft ticking sound can also occur at lower settings.	Normal operation.
Circle of pan bottom remains visible after cleaning.	Contaminated pan bottom used on the cooking zone.	Clean the induction hob with a ceramic hob cleaner and remove the dirt / grease from the pan bottom.
The pans make noise while cooking.	This is caused by the energy flowing from the hob to the saucepan.	This is normal for certain pans, particularly at high settings. This is not harmful to the pans or the hob.
You have switched a cooking zone on, but the display keeps flashing.	The pan you are using is not suitable for induction cooking or has a diameter of less than 12 cm.	Use a suitable pan (see chapter 'Use').
A cooking zone suddenly stops working and you hear a signal.	The preset time has ended.	Switch off the signal by pressing the - or + key on the timer.
The hob is not working and nothing appears in the display.	There is no power supply due to a defective cable or a faulty connection.	Check the fuses or the electric switch (if there is no plug).

Table continued from last page

Symptom	Possible cause	Solution
Zone stops unintended and residual heat indicator is shown.	Zone is overheated.	After the hob has cooled down, cooking can be continued.
A fuse blows as soon as the hob is switched on.	The appliance is incorrectly connected.	Check the electrical connections.
Celsius°Cooking™ key is blinking, together with set cooking method key and display.	Celsius°Cooking™ cookware is assigned to wrong cooking zone.	Remove cookware and assign again.
Unstable connection between cookware and hob.	Low battery of cookware or unstable bluetooth connection.	Switch off the cooktop for 10 seconds and/or change the battery.
Set Celsius°Cooking™ cooking method key is blinking together with set temperature display while using the probe.	Celsius°Cooking™ Probe is removed or not in touch with the content. Or the temperature has fallen rapidly, e.g. due to adding cold water.	Place Probe back or reposition - press cooking method key if probe isn't auto detect.
The ceramic glass plate broke.		Pull the plug out of the socket. Contact your installer.
		Please note! Do not throw a broken ceramic glass plate in the glass recycling bin but take this to the Municipality's waste recycling centre.

Extraction module

Symptom	Possible cause	Solution
The movement of the tower is labored and / or makes more noise.	The pins bearing the tower are dirty.	Clean the pins bearing the tower.
When switching off the hob, the hob will continue to extract at levels 1, 2, or 3, and the extraction indicator pulses.	The Air-Dry function is active. This after-run function ensures that the extraction channels and grease filters are blown dry.	The Air-Dry function is not a setting. However, by turning off the Synchro Stop setting, Air-Dry will only be activated at extraction level 1.

Error codes

Error code	Symptom	Possible cause	Solution
Er03	Er03 appears on display.	The control panel is dirty or has water on it.	Clean the control panel.
E2	E2 appears on display.	Empty pan was heated on the cooking zone.	Wait for cooking zone to cool down or fill the pan with foodstuff.

Troubleshooting

Table continued from last page

Error code	Symptom	Possible cause	Solution
U400	U 400 appears on display with continuous sound tone.	Voltage of the mains is too high.	Connect the appliance in accordance to rating plate and instructions.
E7	E7 appears on display after setting up the Wi-Fi connection.	Failed to connect to Wi-Fi network.	Try to connect the device to your network again. Make sure that new devices can connect to the network (e.g. MAC address filtering is disabled).
E8	E8 appears on display.	Ventilator is blocked (eg possible by item in the drawer).	Unblock the ventilator; disconnect appliance from main voltage for 10 sec.
E65	Celsius°Cooking™ key is blinking, together with E65.	Non-Celsius°Cooking™ cookware is not supported.	Use Celsius°Cooking™ cookware.
E66	E66 is blinking together with the Celsius°Cooking™ key.	Celsius°Cooking™ cookware was not found (empty battery, out of range, etc.).	Replace battery.
E67	E67 is blinking together with the Celsius°Cooking™ key.	Celsius°Cooking™ cookware missing.	If handle cap is mounted correctly; Replace battery .
Extraction module			
E80	E80 appears on display.	The window, with mounted window sensor is not opened.	Open the window to be able to use the extraction module or stop the message by touching the flashing - (minus) or + (plus) key(s).

NOTE!

In case of other error codes: please write down the error code and contact the service department.

Troubleshooting Wi-Fi

Symptom	Possible cause	Solution
Wi-Fi icon not shown.	Wi-Fi turned off.	The hob must be switched off, then touch the on/off key and hold it for 5 seconds.
Wi-Fi setup failed.	Home network issues.	Check that your home network signal is strong and internet connection is working.

Table continued from last page

Symptom	Possible cause	Solution
Home network is not displayed during the connection setup process.	The home network is not on 2.4 GHz, the network is hidden, or the signal strength is too weak.	Please check the network settings. Ensure a 2.4 GHz and visible network. If the signal is too weak, try to move the network router closer to the appliance.
Cooking hob is shown disconnected on the mobile app	Wi-Fi is disabled or home network issues.	Ensure that Wi-Fi is enabled, and the internet connection of your home network is working. Repeat the connection setup if necessary.
Other Wi-Fi problem.	Different causes.	First disable the Wi-Fi and enable it again. Check that the internet connection in your home network is working. Repeat the connection setup if necessary. Further troubleshooting available on www.connectlife.io or contact the service department.
Firmware update process failed.	Internet connection lost or power supply terminated.	Ensure the power supply is not terminated and a stable internet connection before retrying again. If failed again, contact the service department.

Technical data

Information according to regulation (EU) 66/2014

Measurements according EN60350-2 / EN 30-2-1

Model identification	HIHD854GF / HIHD854MM
Trademark	ASKO
Type of hob	Induction hob with integrated extractor
Number of electric cooking zones and/or areas	4
Heating technology	Induction cooking zones and cooking areas
For non-circular cooking zones or areas: length and width of useful surface area per electric heated cooking zone or area	22.0 x 18.0 cm
Energy consumption per cooking zone or area calculated per kg ($EC_{\text{electric cooking}}$) in Wh/kg	188.8
Energy consumption of the hob, calculated per kg ($EC_{\text{electric hob}}$) in Wh/kg	188.8
Annual Energy Consumption (AEC_{hood}) [kWh/a]	28.3
Energy efficiency class	A
Fluid Dynamic Efficiency (FDE_{hood}) [%]	28.6
Fluid Dynamic Efficiency class	A
Grease Filtering Efficiency (GFE_{hood}) [%]	95.7
Grease Filtering Efficiency class	A
Air flow at minimum and maximum speed in normal use [m^3/h]	213.8 - 449.4
Air flow at intensive or boost setting [m^3/h]	617.2
Airborne acoustical A-weighted sound power emissions at minimum and maximum speed in normal use [dB(A)]	44 - 60
Airborne acoustical A-weighted sound power emissions at intensive or boost setting [dB(A)]	68
Power consumption off mode (P_o)	-
Measured power consumption in standby mode (P_s) [W]	0.48 - 0.70 (WiFi)

EU Product Fiche

Model identification	HIHD854GF / HIHD854MM
Time increase factor (f)	1
Energy Efficiency Index (EEI _{hood})	48.8
Measured air flow rate at best efficiency point (Q _{BEP}) [m ³ /h]	346.8
Measured air pressure at best efficiency point (P _{BEP})	230
Measured electric power input at best efficiency point (W _{BEP})	77.6

Compliance information

Radio equipment type	HSCIM - 1 module
Operating frequency range	2402.0 - 2480.0 MHz
Maximum output power	7.63 dBm EIRP average (calculated)
Emission type:	G1D

Radio equipment type	Wi-Fi module
Operating frequency range	2412 - 2472 MHz
Maximum output power	16.8 dBm EIRP average (calculated)
Maximum antenna gain	0 dBi

Radio equipment type	BLE module
Operating frequency range	2402 - 2480 MHz
Maximum output power	7.63 dBm EIRP average (calculated)
Maximum antenna gain	0 dBi

ASKO, with this, declares that the induction hob with integrated extractor including radio equipment complies with Directive 2014/53/EU.

The full text of the EU declaration of conformity is available at the following internet address:
www.celsiuscooking.com/DoC.

Environmental aspects

Disposal of the appliance and packaging

Sustainable materials have been used during the manufacture of this appliance. This appliance must be disposed of responsibly at the end of its service life. Ask your local authorities for more information about how to do this.

The appliance packaging is recyclable. The following may have been used:

- cardboard;
- polyethylene film (PE);
- CFC-free polystyrene (PS rigid foam).

Dispose of these materials in a responsible manner and in accordance with government regulations.

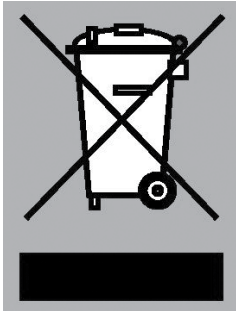

The product has been marked with a crossed-out dustbin symbol to remind you of the obligation to dispose of electrical household appliances separately. This means that the appliance may not be included with normal domestic refuse at the end of its service life. The appliance must be taken to a special municipal centre for separated waste collection or to a dealer providing this service.

A separate collection of household appliances helps to prevent any potential negative impact on the environment and on human health caused by improper disposal. It ensures that the materials of which the appliance is composed can be recovered to obtain significant savings in energy and raw materials.

NOTE!

Please note! Do not throw a broken ceramic glass plate in the glass recycling bin but take this to the Municipality's waste recycling centre.



Declaration of conformity

We hereby declare that our products satisfy the applicable European directives, orders and regulations, as well as the requirements stated in the referenced standards.

Safety

Faulty parts may only be replaced by original parts. The manufacturer can only guarantee that original parts meet safety requirements.

If the supply cord is damaged, it must be replaced by the manufacturer, its service agent or similarly qualified persons in order to avoid a hazard.

Disconnect the appliance from the mains supply before starting any repair work.

If the safety instructions and warnings are not followed, the manufacturer cannot be held responsible for any resulting damage.

This appliance should only be connected by a registered installer.

Check the appliance for transport damage. Do not connect a damaged appliance.

The air must not be discharged into a flue that is used for exhausting fumes from appliances burning gas or other fuels (not applicable to appliances that only discharge the air back into the room).

Extraction hoods and other appliances that extract cooking vapours can affect the safe operation of appliances that burn gas or other fuel (including those in other rooms) by backflowing combustion gases. These gases can potentially lead to carbon monoxide poisoning. After installing an extraction hood or other vapour extractor, the operation of appliances with flue gas extraction must be tested by a competent person to ensure that the combustion gases do not flow back.

Local regulations concerning the discharge of air have to be fulfilled.

Installation

Preparations for installation

Free space around the appliance

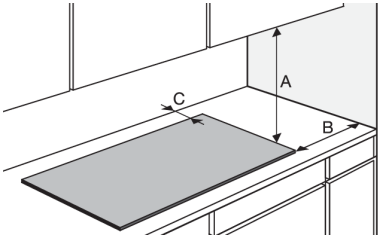

A	min. 550 mm
B	min. 40 mm
C	min. 35 mm

Appliance dimensions

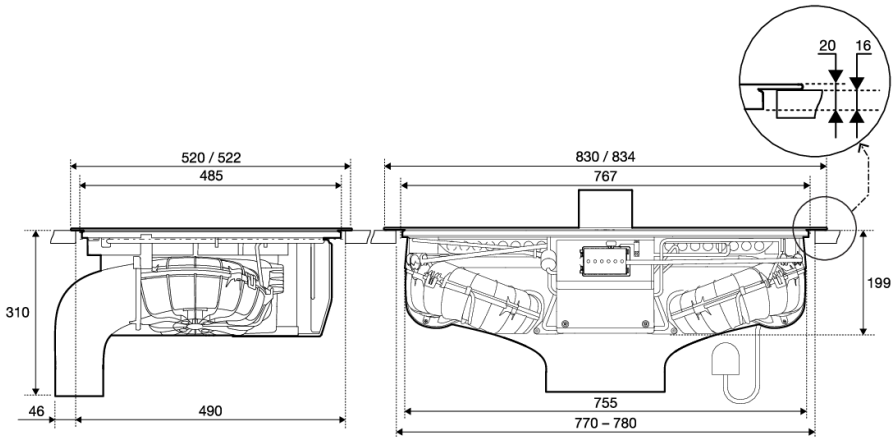

Cut-out in the worktop

Appliances without decorative frames are suitable for flush mounting.

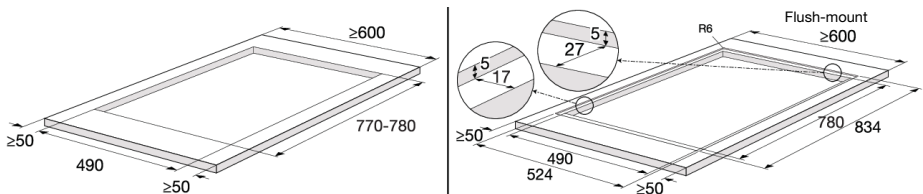

Kitchen cabinet dimensions

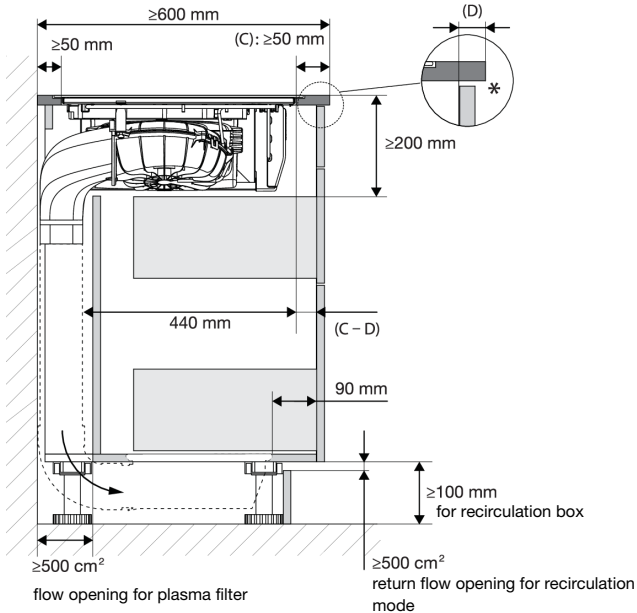

NOTE!

- * A ventilation gap of ≥ 6 mm is advised for optimal hob performance.
- Minimum cabinet width: 800 mm.
- For installation and service, the back panel must be dismantable.
- With recirculation, the humidity can rise. Therefore, a return opening of at least 500 cm² must be provided and the cut surfaces must be made moisture resistant.
- With recirculation, please note that condensation may occur if the kitchen unit is installed against an uninsulated wall or floor. If necessary, choose an alternative recirculation set that is mounted in the plinth.
- The power cord connection is located at the front of the appliance. At least 900 mm length of the power cord is required to lead it to the socket designated location behind the appliance.
- Check the appliance for transport damage. Do not connect a damaged appliance.
- The walls and the worktop surrounding the appliance must be heat resistant up to at least 105 °C.
- The worktop into which the hob is fitted should be flat.

Electrical connection

- This appliance must be earthed.
- The electrical connection must comply with national and local regulations.
- Prior to installation, ensure that the local distribution conditions (voltage and frequency) and the adjustment of the appliance are compatible.

Installation

- The voltage, frequency, power and the country for which the appliance has been designed are shown on the appliance rating plate.
- For class I appliances, check that your home's electrical system provides proper earthing.
- The wall plug socket and plug should always be accessible.
- If a stationary appliance is not fitted with a supply cord and a plug, or with other means for disconnection from the supply mains having a contact separation in all poles that provide full disconnection under overvoltage category III conditions, the means for disconnection must be incorporated in the fixed wiring in accordance with the wiring rules. This is also applicable for appliances with a supply cord and plug when the plug is not accessible after installing the appliance. Using an omnipolar switch with a contact separation of at least 3 mm fitted in the fixed wiring will fulfil this requirement.
- The supply cord must hang freely and should not be fed through a drawer.
- Use an approved cable with the correct cable diameters appropriate for the connection. The cable casing should be able to withstand at least 70 °C and therefore preferably be of type H05V2V2 or H07V2V2.
- Before connecting the appliance, make sure the voltage indicated on the rating plate conforms to the voltage in your power mains.
- The connection should be adjusted to the current and fuses.
- The appliance should not be connected to the mains via a multi-plug adapter or extension cable, as the safe use of the equipment cannot be guaranteed.
- After installation, the parts carrying electrical current and insulated parts shall be protected against contact.

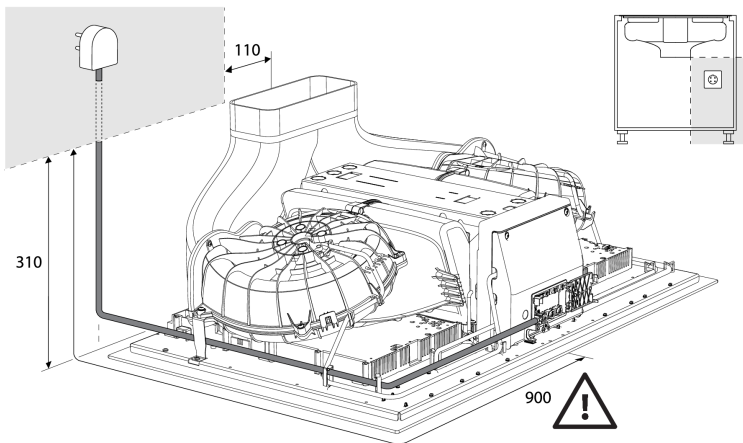

WARNING!

The appliance may only be connected by an authorised expert. False connection can destroy parts of the appliance. In such case, there is no right to warranty. Disconnect the appliance from the power mains before any repair or maintenance operation.

NOTE!

The power cord connection is located at the front of the appliance. At least 900 mm length of the power cord is required to lead it to the socket designated location behind the appliance.

Determining the existing electrical connection

NOTE!

Check the voltage. Before connecting the appliance, make sure the voltage specified on the rating plate conforms to the voltage of your power mains. The voltage of your power mains (220–240 V between L and N) should be checked by an expert using an appropriate measuring device.

Check the voltages present as indicated in the diagrams below.

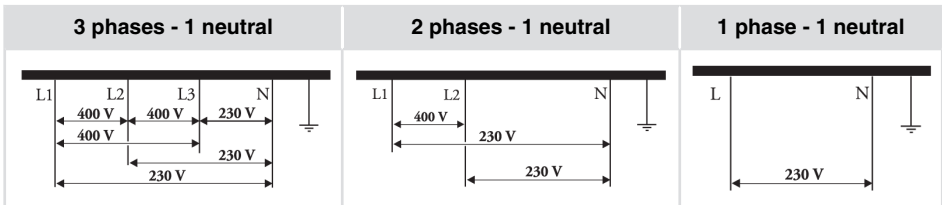

Connection diagram

NOTE!

Consult the wiring diagrams on the front of the appliance.

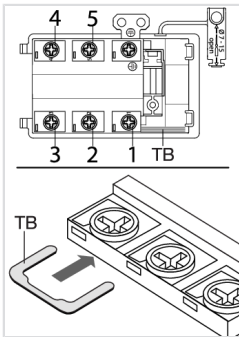

1. Open the cover of the connection terminal box.
2. Run the power cord through a cord strain relief (clamp) which protects the cable from being pulled out.
3. Connect the wires according to your type of appliance.
4. Make the necessary connections between the terminals using the supplied terminal bridges. The terminal bridges are located in the connection box.

Current limiter

See chapter 'Settings', under parameter Con - Current limiter to set the parameter. This parameter must be set before any pan is placed on the hob or cooking zone activated.

Installation

WARNING!

Current limiter setting must be set according to your connection and circuit breakers by a registered and qualified installer. Please read the safety regulations and the installation instructions carefully.

NOTE!

Setting a lower value of the Current limiter parameter will cause a reduced performance of the induction hob.

See the connection diagrams for the voltage between the phase and neutral conductors and voltage between the phase conductors.

Power cord core cross sectional area should be at least 1,5 mm² for the following current limiter settings which should be adjusted to your circuit breakers:

Current limiter settings	Connection type	Power cord Type	Number and cross section of Power cord wires
3x16 A / 3x13 A / 3x10 A / 3x06 A	3 phases - 1 neutral	H05V2V2-F	5 x 1.5 mm ²
2x16 A / 2x13 A / 2x10 A / 2x06 A	2 phases - 1 neutral	H05V2V2-F	4 x 1.5 mm ²
2 x 32 A	2 phases - 1 neutral	H05V2V2-F	4 x 4.0 mm ²
1x48 A / 1x35 A	1 phase - 1 neutral	H05V2V2-F	3 x 6.0 mm ²
1x32 A / 1x25 A	1 phase - 1 neutral	H05V2V2-F	3 x 4.0 mm ²
1x20 A	1 phase - 1 neutral	H05V2V2-F	3 x 2.5 mm ²
1x16 A	1 phase - 1 neutral	H05V2V2-F	3 x 1.5 mm ²

Connecting an 'open window' sensor

The use of sensor type 'FDS 100' is recommended if a window sensor must be installed. The sensor must be of the potential-free NO (normally open) contact type. It must be connected to the designated port on the motor control unit (MCU) in the enclosure at the front of the appliance. A cord of type H05VV-F 2x0,5 mm² (or similar) is recommended for connecting a window sensor. Without a window sensor, a jumper closes the electrical circuit.

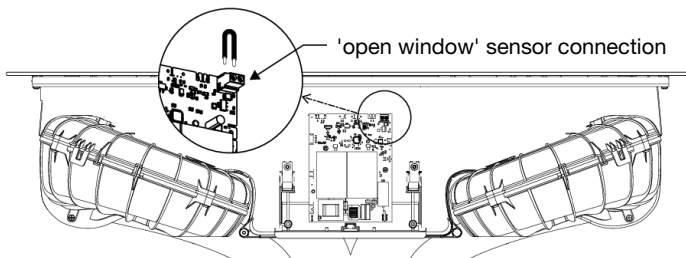

1. Unscrew and remove the cover of the MCU enclosure.
2. Remove the jumper of the sensor connection.
3. Connect the wires of the cord to the sensor connection.
4. Use the available strain relief clamp to secure the cord.
5. Connect the wires of the cord to the window sensor in such a way the contact is open when the window is closed (consult the instructions included with the window sensor).

Installing the appliance

The appliance may only be installed into a temperature- and water-resistant countertop, such as a countertop made of (natural) stone (marble, granite), or solid wood (the edges along the cut-out have to be sealed). When installing into a countertop made of ceramics, wood, or glass, a wooden sub-frame should be used. The frame is not supplied with the appliance. The appliance may only be installed into a countertop made of other materials after you have consulted the countertop manufacturer and obtained his express approval. Internal dimension of the basic unit should be at least equal to the internal cutout for the appliance. This will allow simple removal of the appliance from the countertop. Attach sealing tape along the perimeter of the bottom of the glass panel.

Install the appliance (see 'Installation') and connect the appliance to the mains power supply (see instructions for connecting the appliance). Test the operation of the appliance before applying the seal. Seal the groove between the appliance and the kitchen worktop with a silicone sealant.

The silicone sealant used to seal the appliance must be temperature-resistant (to at least 160 °C). Smooth out the silicone sealant using suitable tools. Observe the instructions for use of the selected silicone sealant. Do not switch on the appliance until the silicone sealant has dried completely.

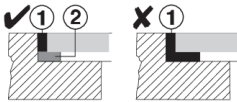

1. Silicone sealant, 2. Sealing tape

NOTE!

Pay particular attention to built-in dimensions with (natural) stone countertops. When choosing the silicone sealant, observe the countertop material and consult the countertop manufacturer. Use of inappropriate silicone sealants can result in permanent discolouration of some parts.

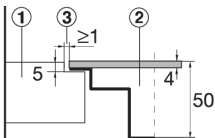

Stone countertop

1. Countertop
2. Appliance
3. Slot

Given the margin of error (tolerance) for the glass ceramic plate of the appliance, and the cutout in the countertop, the slot is adjustable (min. 2 mm).

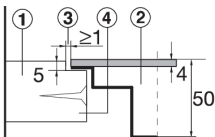

Ceramic, wooden, or glass countertop

1. Countertop
2. Appliance
3. Slot
4. Wooden frame, thickness 16 mm

Installation

WARNING!

The service department shall only be responsible for repairing and servicing the cooking hob. Consult your specialized kitchen equipment dealer regarding re-installing the flush-mount cooking hob.

Built-in

This unit can be connected to various discharge systems:

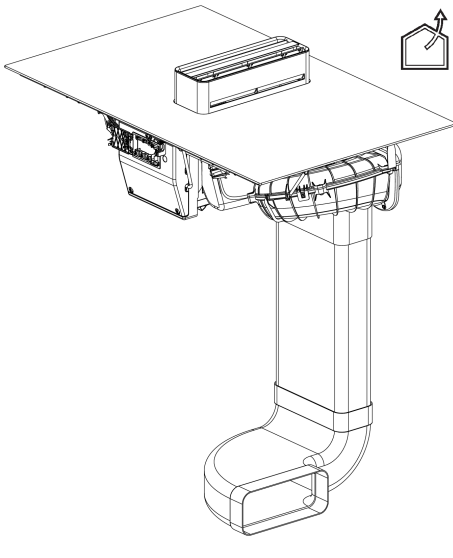
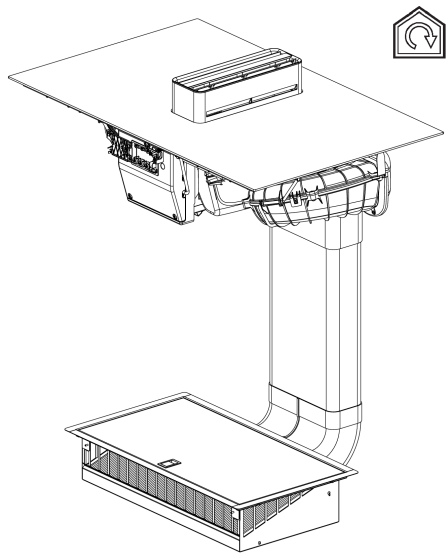
	
<p>To an exhaust duct (outlet)</p> <p>After filtration through grease filters, the extracted air is discharged to the outside through a series of ducts (to be purchased separately).</p> <p>Required parts:</p> <ul style="list-style-type: none">• Connection piece (HD2001)• Exhaust air duct (HD1001)• Vertical / horizontal elbow	<p>To a recirculation filter</p> <p>After filtration through grease filters and the odour control/fine particle filter, the extracted air is discharged back into the room.</p> <p>Required parts:</p> <ul style="list-style-type: none">• Recirculation set including ducts (HR0016)• Replace combi-filter odour/fine dust (HF3010)

Preparation

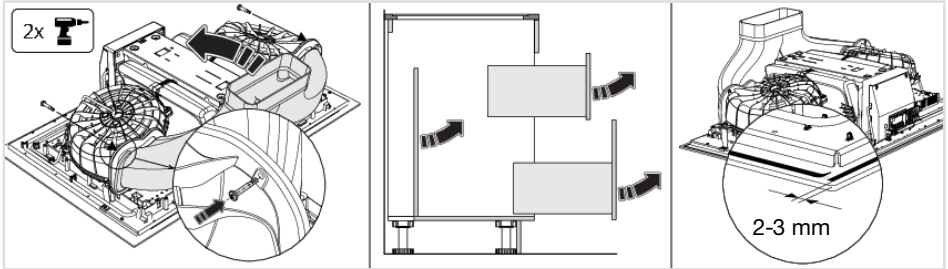

1. Hook the Y-duct into the lower edge of both motor housings and tilt the Y-duct up.
2. Attach the Y-duct to the motor housings with the two screws.
3. Remove the drawers and the back panel from the kitchen cabinet.
4. Before installing the appliance into a kitchen worktop, attach the foam gasket supplied with the appliance to the bottom side of the glass ceramic hob.
5. Remove the protective film from the gasket.
6. Attach the gasket to the bottom side of the glass (2–3 mm away from the edge). The gasket has to be applied along the entire edge of the glass. The gasket may not overlap in the corners.
When fitting the gasket, make sure it is not damaged by or in contact with any sharp objects.



Connecting to an exhaust duct (outlet)

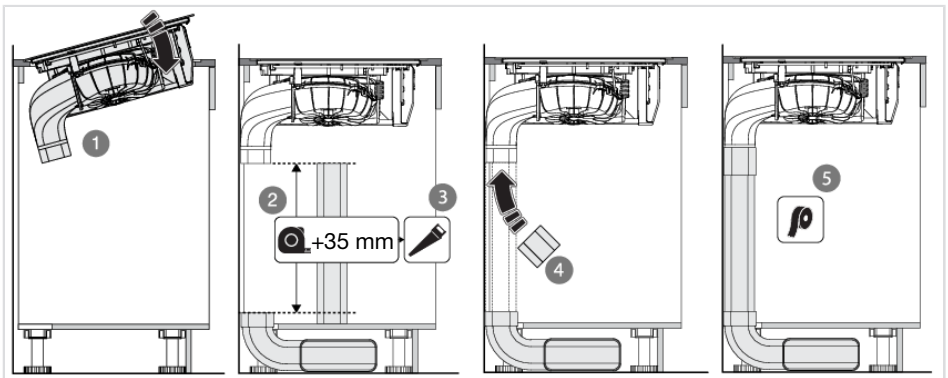

1. Place the appliance in the cut-out in the worktop.
2. Measure the distance as indicated in the figure and add 35 mm.
3. Saw the flat duct to size.
4. Install the coupling, flat duct, and Naber elbow set.
5. Make the duct airtight with sealing tape.

Go to step 16.

Installation



Connecting to a recirculation filter

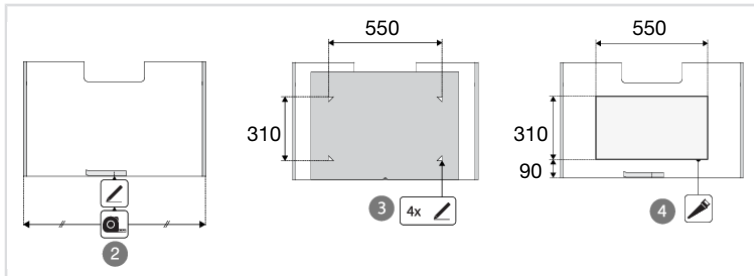

1. Place the appliance in the cut-out in the worktop.
2. Mark the centre of the cabinet bottom with a strip of masking tape.
3. Mark the corners of the cut-out using the template provided.
4. Saw the cut-out in the cabinet bottom and finish the cut surfaces moisture resistant.

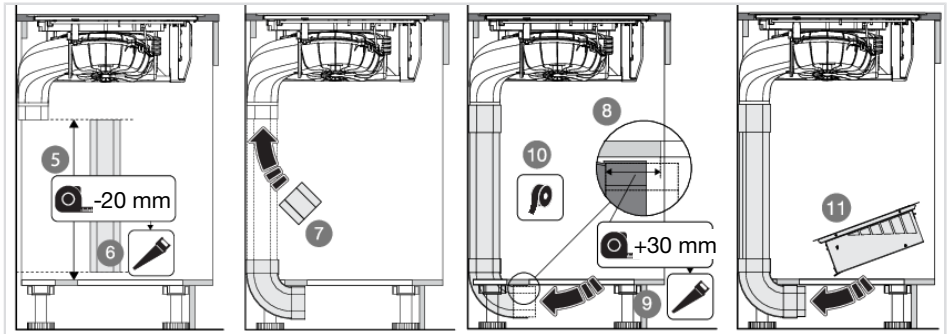

5. Measure the distance as indicated in the figure and subtract 20 mm.
6. Saw the flat duct to size.
7. Install the coupling, the vertical elbow and the flat duct.
8. Measure the distance between the vertical elbow and the cut-out and add 30 mm.
9. Saw the coupling to size. If necessary, use the sawn-off part of the flat channel for this.
10. Make the duct airtight with sealing tape.
11. Place the box.

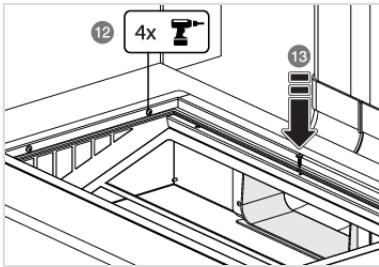

12. Remove the cover of the box and screw the box in place from the inside.

13. Fix the position of the coupling with a screw from the top. Do not forget to pre-drill a hole for the screw.

14. Fit the filter and the cover of the box.

15. Fit the recirculation filter and the cover.

Finish installation

16. Connect the appliance to the power supply with a plug. The socket must be earthed. The nominal voltage and frequency required for the appliance are shown on the appliance's type plate/label with basic information.

17. Fit the back of the cabinet and the drawers.

18. Place the condensation reservoirs, filters, and the tower in the extraction module.

19. Test if the appliance operates correctly.

20. For flush mounting, seal the hob.

Removing the built-in appliance

Disconnect the appliance from the power mains and disconnect it from the discharge duct. Use a suitable tool to remove the silicone seal from around the edge. Remove the appliance by pushing it upwards from the bottom.

NOTE!

Do not attempt to remove the appliance from the upper side of the counter!

The appliance identification card is located on the bottom of the appliance.

Stick the appliance identification card here.

 **ASKO**

Inspired by Scandinavia

www.asko.com



926051-a12

CE

We reserve the right to make changes.