

EN

DEAR CUSTOMER

We thank you and congratulate you on your choice. This new carefully designed product, manufactured with the highest quality materials, has been carefully tested to satisfy all your cooking demands. We would therefore request you to read and follow these easy instructions which will allow you to obtain excellent results right from the start.

THE MANUFACTURER

IMPORTANT

The oven's data plate is accessible even with the oven fully installed. The plate is visible simply by opening the door. Always quote the details from it to identify the appliance when ordering spare parts. The appliance becomes very hot during use. Take great care not to touch the heating elements inside the oven.

CONTENTS

First use
Self-cleaning panel
Respect for the environment
Control panel
Instructions for use:
- conventional cooking
- fan cooking
- grill cooking
Thermostat
Electronic timer
Light replacement
Removing the oven door

INSTALLATION INSTRUCTIONS

Flush fitting
Electrical connections
Technical features
Dimensions

THIS APPLIANCE IS CONCEIVED FOR DOMESTIC USE ONLY. THE MANUFACTURER SHALL NOT IN ANY WAY BE HELD RESPONSIBLE FOR WHATEVER INJURIES OR DAMAGES ARE CAUSED BY INCORRECT INSTALLATION OR BY UNSUITABLE, WRONG OR ABSURD USE. THIS APPLIANCE IS NOT INTENDED FOR USE BY PERSONS (INCLUDING CHILDREN) WITH REDUCED PHYSICAL, SENSORY OR MENTAL CAPABILITIES, OR LACK OF EXPERIENCE AND KNOWLEDGE, UNLESS THEY HAVE BEEN GIVEN SUPERVISION OR INSTRUCTION CONCERNING USE OF THE APPLIANCE BY A PERSON RESPONSIBLE FOR THEIR SAFETY. CHILDREN SHOULD BE SUPERVISED TO ENSURE THAT THEY DO NOT PLAY WITH THE APPLIANCE.



DO NOT PLACE TIN FOIL, PANS OR SIMILAR IN CONTACT WITH THE INNER BASE OF THE OVEN TO COOK. THE HEATING ACTION OF THE LOWER RESISTANCE CAUSES THE LOWER PART OF THE OVEN TO OVERHEAT, LEADING TO DAMAGE AND EVEN SERIOUS CONSEQUENCES (FIRE RISK) ALSO TO THE UNIT IN WHICH THE OVEN IS INSTALLED.

THE FIRST TIME YOU USE THE OVEN

Clean the oven thoroughly with soapy water and rinse well. To remove the lateral frames from smooth-walled ovens, proceed as shown in the picture. Operate the oven for about 30 minutes at maximum temperature to burn off all traces of grease which might otherwise create unpleasant smells when cooking.

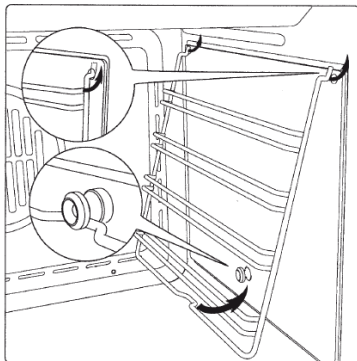

Important:

As a safety precaution, before cleaning the oven, always disconnect the plug from the power socket or the power cable from the oven. Do not use acid or alkaline substances to clean the oven (lemon juice, vinegar, salt, tomatoes etc.). Do not use chlorine based products, acids or abrasive products to clean the painted surfaces of the oven.

DO NOT USE STEAM CLEANERS TO CLEAN THE OVEN.

SELF-CLEANING CATALYTIC PANELS

Our smooth walled ovens can be fitted with selfcleaning panels to cover the inside walls. These special panels are simply hooked on to the walls before the side frames are fitted. They are coated in a special, micro-porous catalytic enamel which oxidises and gradually vaporises splashes of grease and oil at cooking temperatures above 200°C. If the oven is not clean after cooking fatty foods, operate the empty oven for 60 minutes (max.) at maximum temperature. Never wash or clean selfcleaning panels with abrasive, acid, or alkaline products.

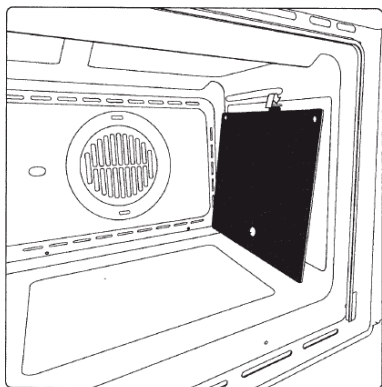











RESPECT FOR THE ENVIRONMENT

The documentation provided with this oven has been printed on chlorine free bleached paper or recycled paper to show respect for the environment. The packaging has also been designed to avoid environmental impact. Packaging material is ecological and can be re-used or recycled. By recycling the packaging, you will help save raw materials as well as reducing the bulk of domestic and industrial waste.



CONTROL PANEL FUNCTIONS

FUNCTION SYMBOLS ON THE SELECTOR

| | |
|---|--|
|  | Oven light (stays on while oven is in use). |
|  | Bottom heating element. Thermostat setting from 50°C to MAX. |
|  | Top and bottom heating elements. Thermostat setting from 50°C to MAX. |
|  | Top and bottom heating elements with fan. Thermostat setting from 50°C to MAX. |
|  | Circular heating element with fan. Thermostat setting from 50°C to MAX. |
|  | Fan for defrosting. Thermostat setting at 0°C. |
|  | Bottom heating element with fan. Thermostat setting from 50°C to MAX. |
|  | Double top heating element with fan (large area grill). Thermostat setting from 50°C to 200°C. |
|  | Double top heating element (large area grill). Thermostat setting from 50°C to 200°C. |
|  | Top heating element (small, low power grill). Thermostat setting from 50°C to 200°C. |
|  | Bottom heating element + Circular heating element with fan. Thermostat setting from 50°C to MAX. |

INSTRUCTIONS FOR USE

CONVENTIONAL COOKING



Conventional cooking uses top and bottom heat to cook a single dish. Place the food in the oven only once cooking temperature has been reached, i.e. when the heating indicator goes out. If you want to increase top or bottom temperature towards the end of the cooking cycle, set the temperature control to the right position. It is advisable to open the oven door as little as possible during cooking.

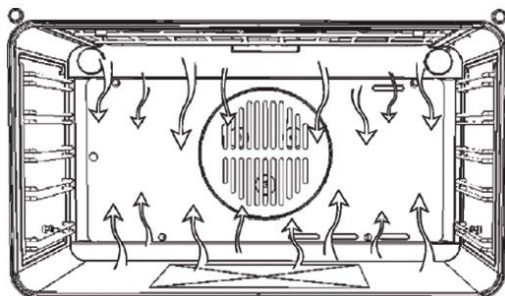

FAN COOKING



For this type of cooking a fan positioned at the back allows the circulation of hot air inside the oven, creating uniform heat. In this way cooking is more rapid than conventional cooking. It is a suitable method for cooking dishes on more than one shelf, especially when the food is of different types (fish, meat etc.)

DEFROSTING



By selecting one of the fan cooking functions and setting the thermostat to zero, the fan allows cold air to circulate inside the oven. In this way frozen food can be rapidly defrosted.

It is not essential to preheat the oven, but you are advised to do so when cooking pastries.

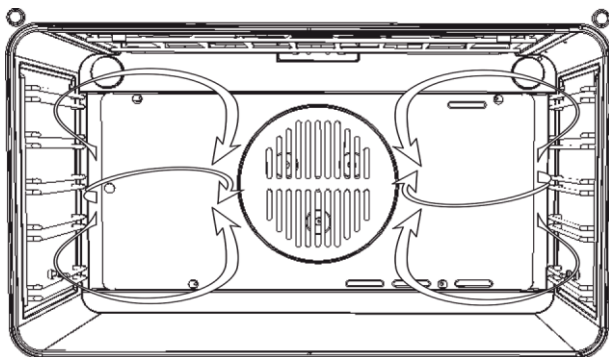

GRILL COOKING



Use the grill to grill or brown foods. Some ovens may be equipped with an electric motor, spit and skewers for turning on the spit. Place the shelf with the food to be cooked in the 1st or 2nd position from the top. Pre-heat the oven for 5 minutes. Turn the thermostat to a temperature between 50°C and 200°C.

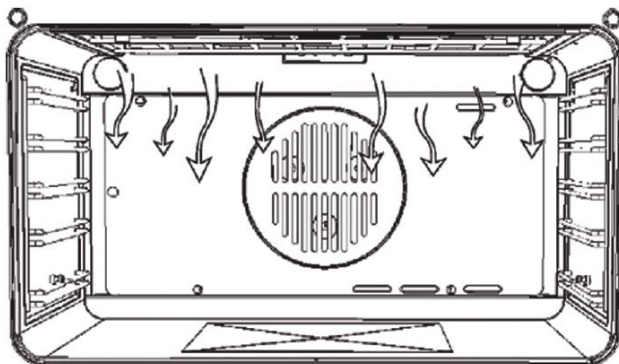

COOLING FAN

The fan is positioned on the upper part of the oven and create a circle of cooling air on the inside of the furniture and through the door of the oven. It is turned on when the temperature of the outer shell of the oven reaches 60°C. By switching on the oven with the thermostat at 200°C the fan starts working after approx. 10 min. It is turned off when the temperature of the outer shell of the oven descends under 60°C. By switching off the oven with the thermostat at 200°C the fan stops working after approx. 30 min.

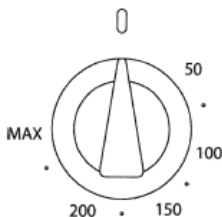

THERMOSTAT

Use the thermostat to set the cooking temperature you need. The thermostat can be adjusted from 50°C to 250°C.

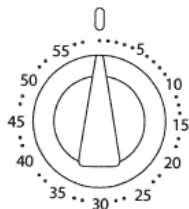

ALARM TIMER

You can set this timer to sound a buzzer after 0 to 60 minutes of cooking. First turn the knob fully clockwise, then turn it back to the desired alarm time.

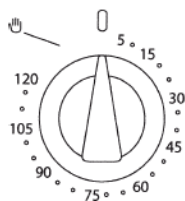



COOKING TIMER

First, turn the cooking selector to the required cooking function, and the thermostat to the desired cooking temperature. Then, to set end of cooking time, turn the cooking timer to the right and to the desired time. First turn the knob fully clockwise, then turn it back to the desired alarm time. A buzzer sounds at the end of the timed cooking period, and the oven switches itself off. To set only the start of cooking, turn the cooking timer to the left to the symbol .

6 KEY ELECTRONIC TIMER

Setting the clock

Press the duration key  and the end of cooking  key simultaneously, then press the +/- keys to set the time.



MANUAL OPERATION

To start cooking without setting *end of cooking time*, press the manual key .



SETTING ONLY THE DURATION OF COOKING IN SEMI-AUTOMATIC MODE

To set the *duration of cooking*, press the duration key and press the +/- keys to set the duration of cooking. A buzzer sounds when the cooking period finishes, and the oven switches itself off. Turn the thermostat and selector knobs back to 0 position and press the manual key.

SETTING ONLY THE END OF COOKING TIME IN SEMI-AUTOMATIC MODE

To set the *end of cooking time*, press the end of cooking key  and press the +/- keys to set the time at which you want the oven to switch off. A buzzer sounds when the clock reaches the set time, and the oven switches itself off. Turn the thermostat and selector knobs back to 0 position and press the manual key.

FULLY AUTOMATIC OPERATION

To set the *end of cooking time*, press the duration key  and press the +/- keys to set the duration of cooking. Press the end of cooking key  and press the +/- keys to set the time at which you want the oven to switch off. When you finish setting these times, the AUTO symbol flashes and the buzzer sounds. Press any key to silence it.

ALARM TIMER

Press the alarm timer key and press the +/- keys to set the required duration of cooking. The *buzzer* sounds when the cooking time ends. Press any key to silence it.

PROGRAMMING ERRORS

You cannot program in a cooking period which starts earlier than the time displayed on the clock. If you try to do so, the buzzer sounds and the AUTO symbol flashes. Simply change the duration or cooking time to correct the error.

CANCELLING A COOKING PROGRAMME

To cancel a cooking programme, simply press the manual key.

REPLACING THE OVEN LIGHT

IMPORTANT:

The oven light must have these precise features:

a) it must be able to resist high temperatures (up to 300°C)

b) power supply: see V/Hz indicated on data plate.

c) power 25W.

d) E 14 connection.

Before proceeding, disconnect the appliance from the main electricity supply.

- to prevent damage, place a tea cloth in the oven
- unscrew the glass cover of the light
- unscrew the old light bulb and replace it with the new one
- put back the glass cover and remove the tea cloth
- connect the appliance to the main electricity supply.



REMOVING THE OVEN DOOR

The oven door can be removed quickly and easily.

To do so, proceed as follows:

- Open the door fully.
- Lift the two levers shown in the picture.
- Close the door as far as the first stop (caused by the raised levers).
- Lift the door upwards and outwards to remove it from its mountings.

To replace fit the door, fit the hinges in their mountings and lower the two levers.

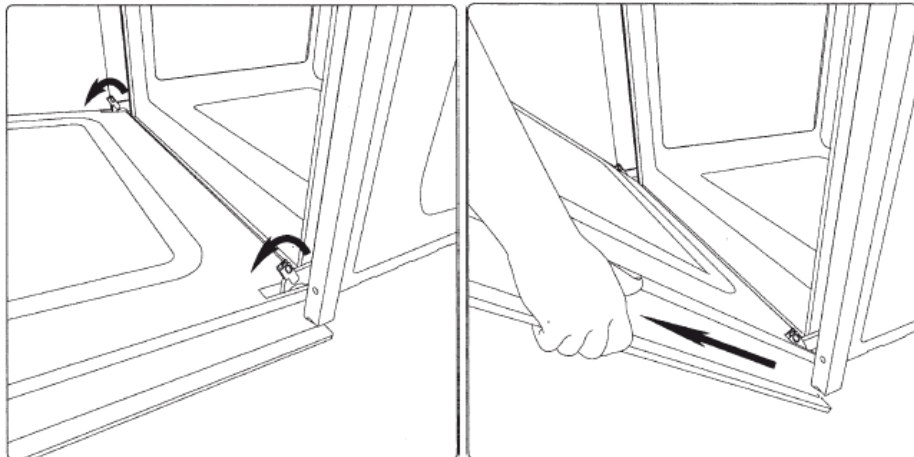

INSTALLATION INSTRUCTIONS

Flush fitting

The oven can be installed under a work top or in a cooking column. Picture shows the installation dimensions. Make sure that surrounding materials are heat resistant. Align the oven centrally with respect to the side walls of the units surrounding it and fix it in place with the screws and Allen screws provided.

ELECTRICAL CONNECTIONS

Before connecting the oven to the mains power supply, make sure that:

- The supply voltage corresponds to the specifications on the data plate on the front of the oven.
- The mains supply has an efficient earth (ground) connection complying with all applicable laws and regulations. Correct earthing (grounding) is a legal requirement.

The power cable should never reach a temperature 50°C above ambient temperature at any point along its length.

If a fixed appliance is not provided with a power cable and plug, or some other device permitting it to be disconnected from the mains electricity supply, with a gap between the contacts big enough to guarantee class III overvoltage protection, then such a device must be fitted to the power supply in compliance with the regulations governing electrical installations. The socket or switch must be easily reachable with the oven fully installed.

| CABLE TYPES AND MINIMAL DIAMETERS | |
|-----------------------------------|---------------------------------|
| | SASO |
| H05RR-F 3x1,5 mm ² | H05RR-F 3x2,5 mm ² |
| H05VV-F 3x1,5 mm ² | H05VV-F 3x2,5 mm ² |
| H05RN-F 3x1,5 mm ² | H05RN-F 3x2,5 mm ² |
| H05V2V2-F 3x1,5 mm ² | H05V2V2-F 3x2,5 mm ² |

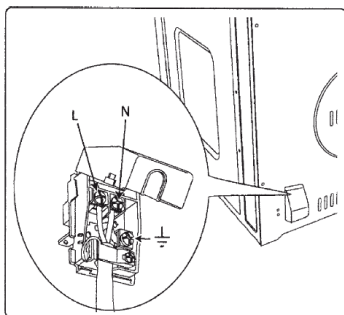

N.B. The manufacturer declines all responsibility for damage or injury if the above instructions and normal safety precautions are not respected.

| TECHNICAL FEATURES | | |
|------------------------------|-------------------|--|
| MUFFLE SIZE | Length (mm) - 607 | CAVITY VOLUME (conventional/fan assisted) 75 litres |
| | Height (mm) - 335 | |
| | Depth (mm) - 390 | |
| HEATING ELEMENT POWER RATING | | |
| Roof element, external | 1100 W | |
| Roof element, internal | 1750 W | |
| Circular element | 2300 W | |
| Bottom element | 1300 W | |

Built-under type

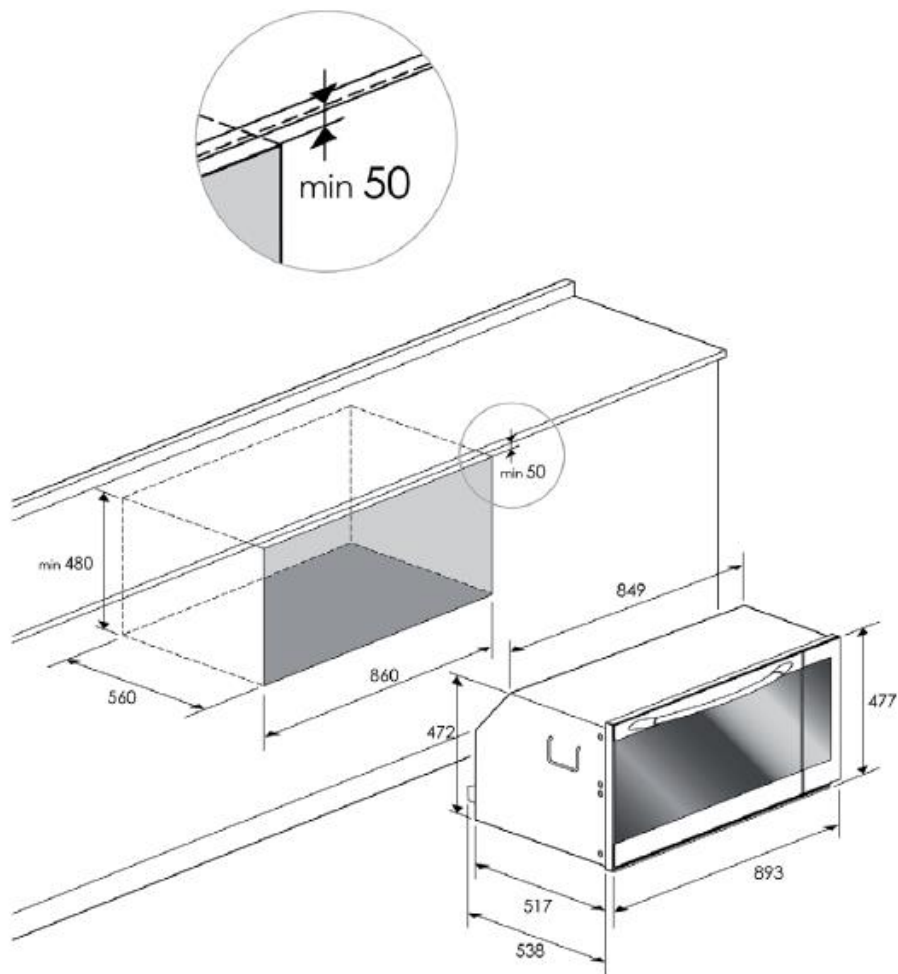

Vertical type

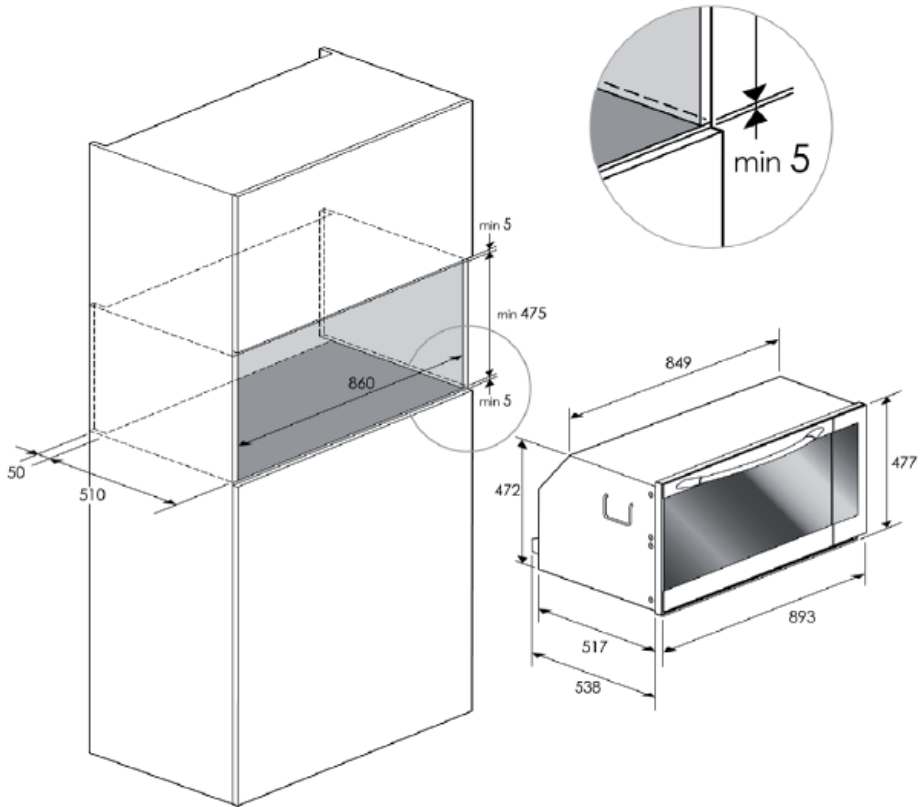

The manufacturer declines all responsibility for possible inaccuracies contained in this pamphlet, due to printing or copying errors. We reserve the right to make on our own products those changes to be considered necessary or useful, without jeopardizing the essential characteristics.