

**gorenje**

EN

GB

IE

## **INSTRUCTIONS FOR USE**

Induction hob

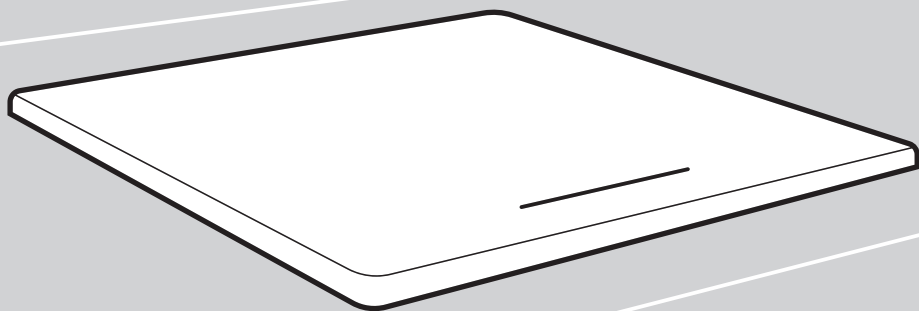

GI3, GI6

We thank you for your trust and the purchase of our appliance.

This detailed instruction manual is supplied to make the use of this product easier. The instructions should allow you to learn about your new appliance as quickly as possible.

Make sure you have received an undamaged appliance. If you do find transport damage, please contact the seller from which you purchased the appliance, or the regional warehouse from which it was supplied. The telephone number can be found on the invoice or on the delivery note.

Instructions for use are also available at our website:

[www.gorenje.com](http://www.gorenje.com) / < <http://www.gorenje.com> />



**INFORMATION!**

Information, advice, tip, or recommendation



**WARNING!**

Warning – general danger

# Contents

<b>1. Safety precautions</b>	<b>4</b>
<b>2. Other important safety warnings</b>	<b>6</b>
2.1 Before connecting the appliance	6
<b>3. Induction hob installation</b>	<b>7</b>
3.1 Flush-mount installation into the worktop	10
3.2 Fitting the foam gasket	13
<b>4. Connecting the induction hob to the power mains</b>	<b>13</b>
4.1 Power cord	13
4.2 Connecting the appliance	14
<b>5. Appliance description</b>	<b>17</b>
5.1 Before first use	17
<b>6. Operating the cooking hob</b>	<b>18</b>
6.1 Control unit	18
6.2 Powering on the induction cooking hob	19
6.3 Switching on the cooking zones	19
6.4 Bridged cooking zone	19
6.5 Automatic rapid heating	20
6.6 Power Boost	21
6.7 Child lock / lock	22
6.8 Time functions	22
6.9 Residual heat indicator	24
6.10 Maximum cooking time	24
6.11 Overheat protection	24
6.12 Automatic switch off	24
6.13 Switching off the cooking zone	25
6.14 Switching off the entire cooking hob	25
<b>7. User settings</b>	<b>26</b>
<b>8. Tips and hints</b>	<b>28</b>
8.1 Cooking hob (conventional or glass ceramic)	28
8.2 Induction cooking zone operating principle	28
8.3 Induction cookware	29
8.4 Energy saving tips	30
<b>9. Cleaning and maintenance</b>	<b>31</b>
<b>10. Problems and errors</b>	<b>32</b>
10.1 Noises during induction cooking	33
<b>11. Technical data</b>	<b>33</b>
<b>12. Disposal</b>	<b>34</b>

# 1. Safety precautions

## **IMPORTANT SAFETY PRECAUTIONS – CAREFULLY READ THE INSTRUCTIONS AND SAVE THEM FOR FUTURE REFERENCE.**

This appliance can be used by children aged from 8 years and above and persons with reduced physical, sensory or mental capabilities or lack of experience and knowledge if they have been given supervision or instruction concerning use of the appliance in a safe way and understand the hazards involved. Children shall not play with the appliance. Cleaning and user maintenance shall not be made by children without supervision.

**WARNING:** The appliance and its accessible parts become hot during use. Care should be taken to avoid touching heating elements.

Children less than 8 years of age shall be kept away unless continuously supervised.

Do not use steam cleaners or high-pressure cleaners to clean the appliance, as this may result in an electric shock.

The appliance is not intended to be controlled by external timers or separate remote control system.

Means for disconnection must be incorporated in the fixed wiring in accordance with the wiring rules.

If the supply cord is damaged, it must be replaced by the manufacturer, its service agent or similarly qualified persons in order to avoid a hazard (only for appliances supplied with connection cord).

**WARNING:** If the surface is cracked, switch off the appliance to avoid the possibility of electric shock. Switch off all cooking zones using their respective controls and remove the fuse or trip the main circuit breaker so that the appliance is fully isolated from the power mains.

**WARNING:** Unattended cooking on a hob with fat or oil can be dangerous and may result in fire. NEVER try to extinguish a fire with water, but switch off the appliance and then cover flame e.g. with a lid or a fire proof blanket.

**WARNING:** Danger of fire: do not store items on the cooking surfaces.

**CAUTION:** The cooking process has to be supervised. A short term cooking process has to be supervised continuously.

**CAUTION:** This appliance is for cooking purposes only. It must not be used for other purposes, for example room heating.

**WARNING:** Use only hob guards designed by the manufacturer of the cooking appliance or indicated by the manufacturer of the appliance in the instructions for use as suitable or hob guards incorporated in the appliance. The use of inappropriate guards can cause accidents.

Metalic objects such as knives, forks, spoons and lids should not be placed on the hob surface since they can get hot.

After use, switch off the hob element by its control and do not rely on the pan detector.

Appliance must be connected to fixed wiring which has incorporated means of disconnection. Fixed wiring must be made in accordance with the wiring rules.

## 2. Other important safety warnings

The appliance is intended for household use. Do not use it for any other purpose, such as room heating, drying of pets or other animals, paper, fabrics, herbs etc. As this may lead to injury or fire hazard.

Appliance must be connected to fixed wiring which has incorporated means of disconnection. Fixed wiring must be made in accordance with the wiring rules.

If another electrical appliance is connected to an AC power socket near the appliance, make sure the power cord does not come in to contact with hot cooking zones.

If the power cord is damaged, it should be replaced by the manufacturer or an authorised service technician, in order to avoid hazard.

Using the glass ceramic hob as a storage area may result in scratches or other damage to it. Never heat food in aluminium foil or in plastic containers on the cooking hob. Such foil or containers may melt which can result in a fire or damage to the cooking hob.

Do not store temperature-sensitive items underneath the appliance, such as cleaners or detergents, spray cans etc.

Eventual mismatches in colour shades between different appliances or components within a single design line may occur due to various factors, such as different angles under which the appliances are observed, different coloured backgrounds, materials, and room illumination.

### 2.1 Before connecting the appliance



#### **WARNING!**

**Carefully read the instructions for use before connecting the appliance. Repair or any warranty claim resulting from incorrect connection or use of the appliance shall not be covered by the warranty.**

### 3. Induction hob installation

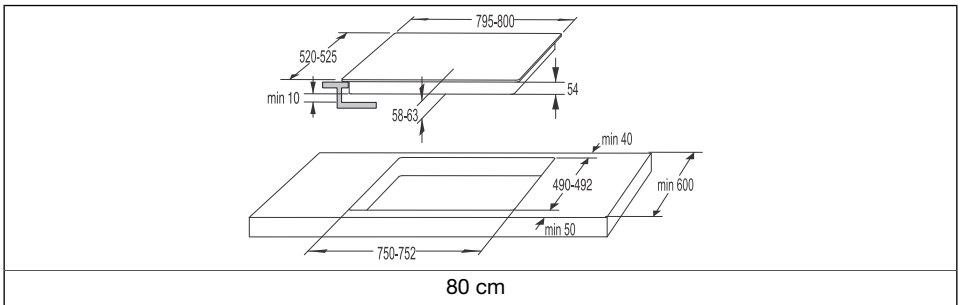
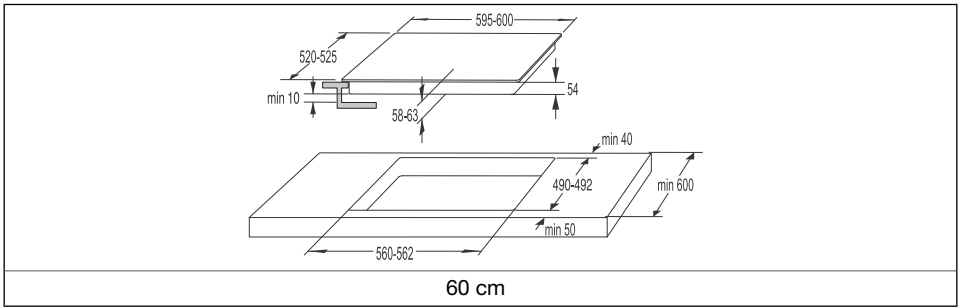
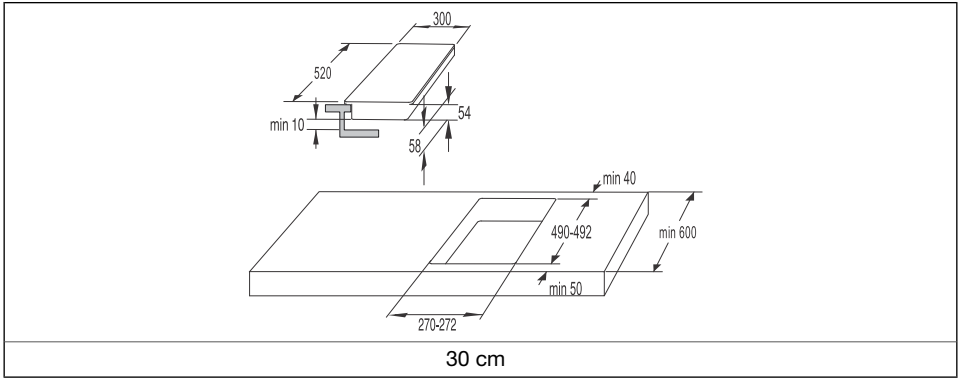

#### INFORMATION!

Installation of the appliance into a kitchen worktop and its connection to the power mains may only be performed by an adequately qualified technician.

## Installation procedure

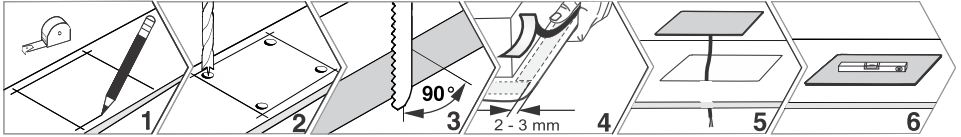

- Suitably protect the edges of the cut aperture.
- Connect the induction cooking hob to the mains power supply (see instructions for the connection of the induction cooking hob to mains power supply).
- Place the induction hob into the cut aperture.
- Veneer or other finish of the piece of kitchen furniture into which the hob is to be built in should be treated with heat resistant glue (100 °C); otherwise, the worktop finish may be discolored or deformed.
- Use of solid wood corner trims on worktops behind the induction cooking hob is only allowed if the clearance between the trim and the hob is no smaller than indicated on the installation plans.



### INFORMATION!

The worktop has to be completely level.

<p>(mm)</p> <p>min 500</p> <p>min 40</p>	<ul style="list-style-type: none"> <li>• The induction hob is suitable for installation into a worktop above a kitchen cabinet with a minimum width of 600 mm.</li> <li>• Any kitchen cabinetry suspended above the induction hob should be high enough not to disturb the work process.</li> <li>• The vertical distance between the induction hob and the kitchen hood must be at least the distance specified in the instructions for installation of the kitchen hood and no less than 500 mm.</li> <li>• The distance between the edge of the induction hob and the adjacent kitchen cabinet should be no less than 40 mm.</li> <li>• Minimum clearance between the induction hob and the rear wall is indicated in the installation diagram.</li> </ul>
--	---



### Lower cabinet with a drawer

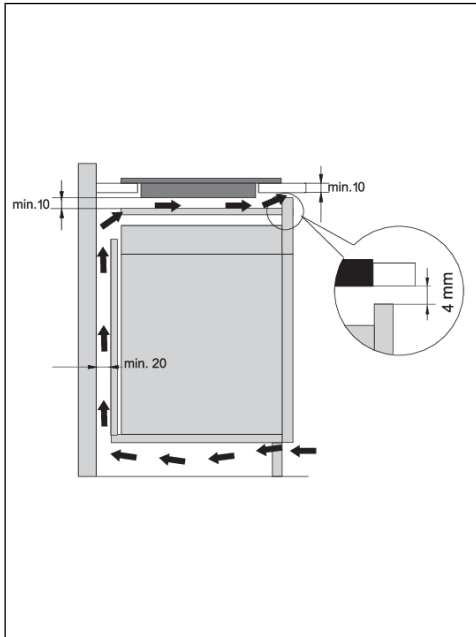

- There must be an opening with a height of no less than 140 mm along the entire width of the cabinet in the cabinet rear wall. In addition, there should be an opening of at least 4 mm in the front side, along the entire width of the cabinet.
- A horizontal partition panel should be installed underneath the induction hob along its entire length. There should be at least 10 mm of clearance between the lower end of the hob and the partition panel.
- Adequate ventilation should be allowed from the rear side.
- If there is a drawer under the kitchen cabinet, do not store aluminium foil or flammable substances or liquids (such as sprays) in this drawer. Keep such substances away from the cooking hob. Danger of explosion!

### Lower cabinet with an oven

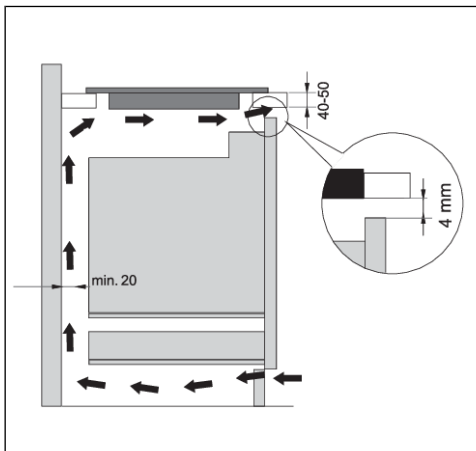

- Installing an oven under the induction hob is possible for oven models with a cooling fan.
- Before installing the oven, the kitchen cabinet rear wall has to be removed in the area of the opening for installation.
- In addition, there should be an opening of at least 4 mm on the front side, along the entire width of the cabinet.
- If other appliances are installed under the induction cooking hob we cannot guarantee their correct operation.

### INFORMATION!

Normal operation of the induction cooking hob electronic components requires sufficient air circulation.

### 3.1 Flush-mount installation into the worktop

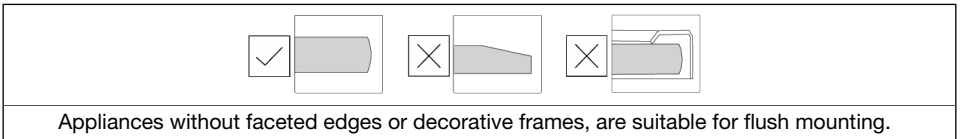
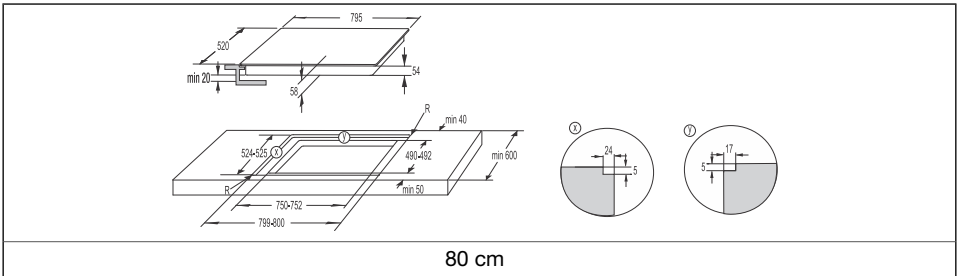
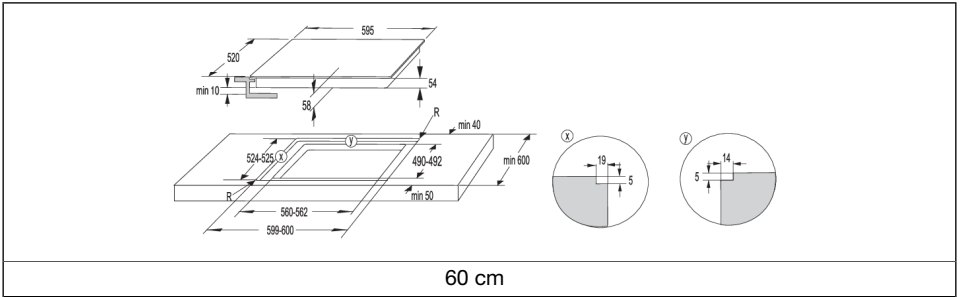
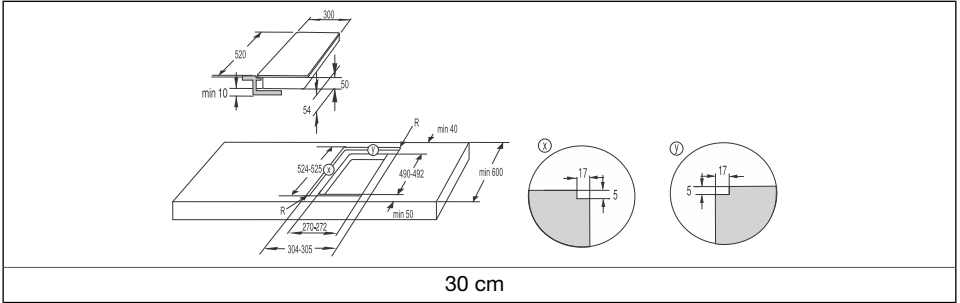

#### Installation procedure

- The appliance may only be installed into a temperature- and water-resistant countertop, such as a countertop made of natural stone (marble, granite) or solid wood (the edges along the cut-out have to be sealed).

- When installing into a countertop made of ceramics, wood, or glass, a wooden sub-frame should be used. The frame is not supplied with the appliance. The appliance may only be installed into a countertop made of other materials after you have consulted the countertop manufacturer and obtained his express approval.
- Internal dimension of the basic unit should be at least equal to the internal cut-out for the appliance. This will allow simple removal of the appliance from the countertop.
- Attach sealing tape along the perimeter of the bottom of the glass panel.

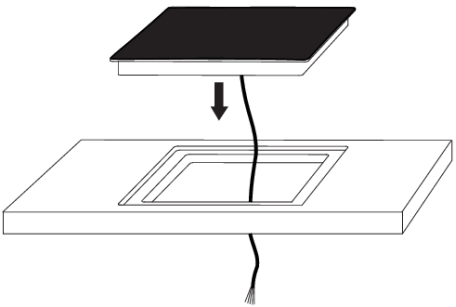
	<ol style="list-style-type: none"> <li>1. First, feed the power cord through the cut-out.</li> <li>2. Place the appliance over the centre of the cut-out.</li> <li>3. Connect the appliance to the power mains.</li> <li>4. Test appliance operation.</li> <li>5. Seal the slot between the appliance and the countertop using a silicone sealant. The silicone sealant used to seal the appliance has to be temperature-resistant (to at least 160 °C).</li> <li>6. Smooth out the silicone sealant using a suitable tool. Do not switch on the appliance until the silicone sealant has dried completely.</li> </ol>
--	--

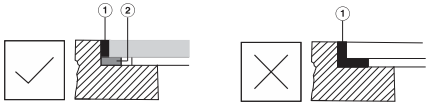

<ol style="list-style-type: none"> <li>1. Silicone sealant</li> <li>2. Sealing tape</li> </ol>

### Stone countertop

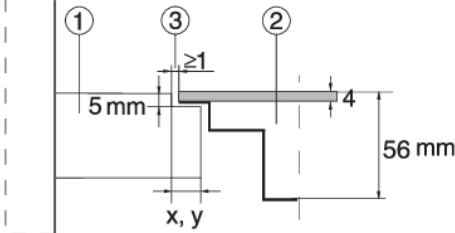

#### WARNING!

Pay particular attention to built-in dimensions with (natural) stone countertops. When choosing the silicone sealant, observe the countertop material and consult the countertop manufacturer. Use of inappropriate silicone sealants can result in permanent discolouration of some parts.

	<ol style="list-style-type: none"> <li>1. Countertop</li> <li>2. Appliance</li> <li>3. Slot</li> </ol>
<p>Given the margin of error (tolerance) for the glass ceramic plate of the appliance, and the cutout in the countertop, the slot is adjustable (min.2 mm).</p>	

### Ceramic, wooden, or glass countertop

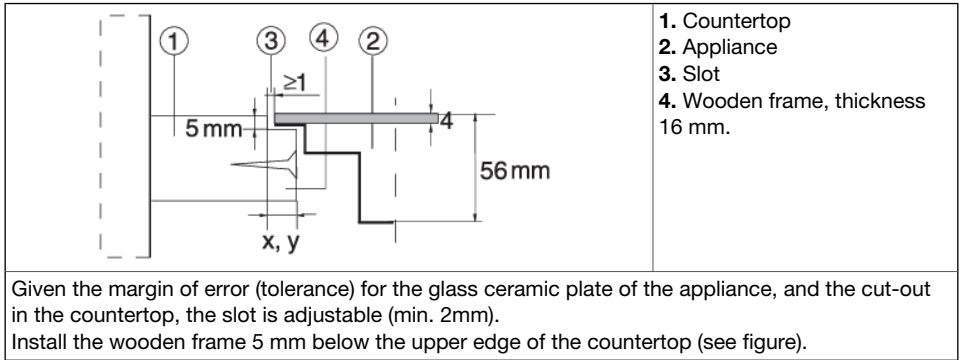

### Observe the radii of glass edges (R10, R2) when making the cut-out.

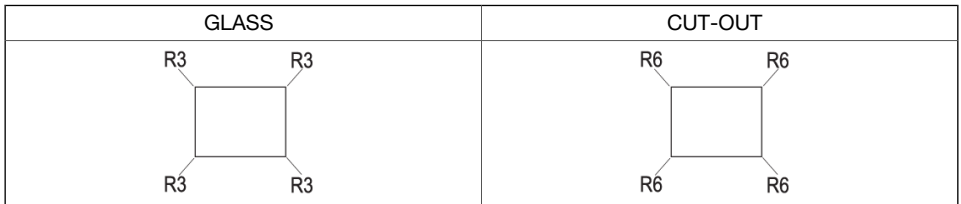

### Removing the built-in appliance

Disconnect the induction hob from the power mains. Use a suitable tool to remove the silicone gasket from the perimeter. Remove the induction hob by pressing from the lower side upwards.

**⚠ WARNING!**  
Do not attempt to remove the appliance from the upper side of countertop.

**⚠ WARNING!**  
The service department shall only be responsible for repair and servicing of the induction hob. Consult your specialized kitchen equipment dealer regarding the re-installation of the flush-mount induction hob.

**⚠ WARNING!**  
If the oven is installed under a flush-mounted induction hob, then the worktop thickness should be at least 45 mm.

## 3.2 Fitting the foam gasket

Before installing the induction hob into a kitchen worktop, attach the foam gasket supplied with the appliance to the bottom side of the hob. Some appliances come with the gasket already fitted!

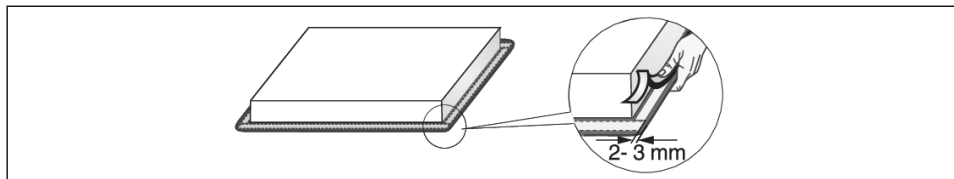

1. Remove the protective film from the gasket.
2. Attach it to the bottom side of the glass surface, 2–3 mm away from the edge, along the entire perimeter of the glass panel.
3. The gasket may not overlap in the corners.
4. When fitting the gasket, make sure it is not damaged by or in contact with any sharp objects.

### **WARNING!**

Do not install the appliance without the gasket!

## 4. Connecting the induction hob to the power mains

- Power mains protection must conform to the relevant regulations.
- Before connecting the appliance, make sure the voltage specified on the rating plate conforms to the voltage of the power mains.
- There should be a switching device in the electrical installation that can disconnect all poles of the appliance from the power mains, with a minimum clearance of 3 mm between the contacts when open. Suitable devices include fuses, protective switches etc.
- The connection should be adjusted to the current and fuses.
- After installation, the parts carrying electrical current and insulated parts shall be protected against contact.

### **WARNING!**

The appliance may only be connected by an authorised expert. False connection can destroy parts of the appliance. In such case, there is no right to warranty! Disconnect the appliance from the power mains before any repair or maintenance operation.

### 4.1 Power cord

(appliance without a power cord)

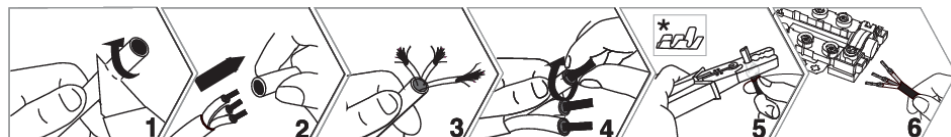

\* Ferrules are not supplied.



## INFORMATION!

We recommend using electric wire ferrules (end terminals).

- The following may be used for connection: PVC insulated connection cables type H05V2V2-F with yellow-and-green protective conductor, or other equivalent or superior cables.
- Exterior cable diameter should be at least 8.0 mm.
- Run the power cord through a cord strain relief (clamp) which

## 4.2 Connecting the appliance

### Connecting a 60-cm, 80-cm appliance

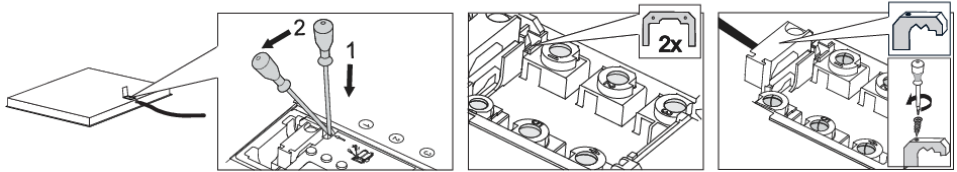

1. Open the cover of the connection terminal box.
2. Connect the wires according to your type of appliance. The jumpers are provided on the connection terminal.
3. Run the power cord through a cord strain relief (clamp) that protects the cable from being pulled out.

Connection diagram	
<p>220-240V ~ / 50-60Hz</p>	<p><b>Single phase connection (32 A)</b></p> <ul style="list-style-type: none"> <li>• Single-phase connection (1 1N, 220–240 V~ /50–60 Hz): <ul style="list-style-type: none"> <li>- Voltage between line and neutral conductor is 220–240 V~. Install a jumper between terminals 1 and 2, and between terminals 4 and 5.</li> <li>- The circuit should be fitted with a fuse of at least 32 A. Power cord core cross-sectional area should be at least 4 mm<sup>2</sup>.</li> </ul> </li> </ul>
<p>380-415V 2N ~ / 50-60Hz</p>	<p><b>2-phase connection (16A)</b></p> <ul style="list-style-type: none"> <li>• 2 phases, 1 neutral conductor (2 1N, 380–415 V~ /50–60 Hz): <ul style="list-style-type: none"> <li>- Voltage between the line and neutral conductor is 220–240 V~.; voltage between lines is 380–415 V~. Install a jumper between the terminals 4 and 5. The circuit should be fitted with at least two fuses of at least 16 A each. Power cord core cross-sectional area should be at least 1.5 mm<sup>2</sup>.</li> </ul> </li> </ul>
<p>220-240V 2 2N ~ / 50-60Hz</p>	<ul style="list-style-type: none"> <li>• 2 phases, 2 neutral conductors (2 2N, 220–240 V 2 2N ~ /50–60Hz): <ul style="list-style-type: none"> <li>- Voltage between phases and neutral conductor is 220-240 V~.</li> <li>- The circuit should be fitted with at least two fuses of at least 16 A each. Power cord core cross-sectional area should be at least 1.5 mm<sup>2</sup>.</li> </ul> </li> </ul> <p><b>only for NLI!</b></p>

## Connecting the power cord to the power mains

(appliance with a power cord)

- The cooking hob has to be hard-wired directly to the power mains.
- Devices for disconnecting from the power mains have to comply with the relevant regulations.
- Do not extend the power cord and do not lead it over sharp edges.
- If the appliance is installed above an oven, make sure the power cord is never in contact with the oven's hot parts.

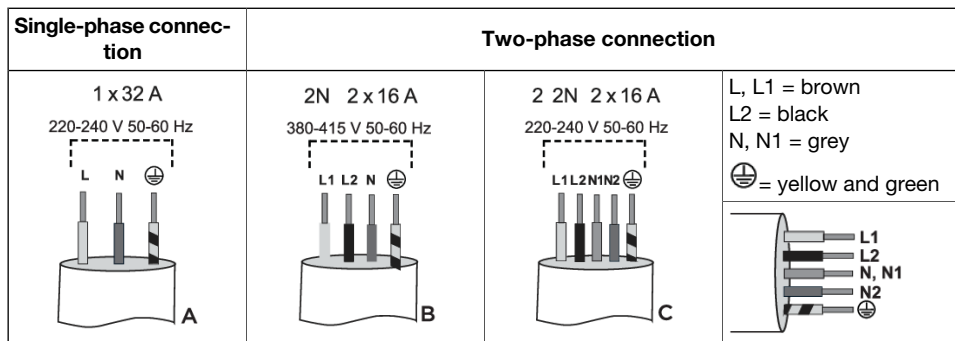

Single-phase connection	Two-phase connection	
<p>Connect the hob as shown in Diagram A. If your power mains do not allow a 32 A fuse, the appliance power should be decreased or limited accordingly.</p>	<p>If your electric mains have 2 line conductors and 1 neutral conductor, connect the appliance as shown in Diagram B.</p>	<p>If your electric mains have 2 line conductors and 2 neutral conductors, connect the appliance as shown in Diagram C. <b>only for NL!</b></p>

## Connecting a 30-cm appliance

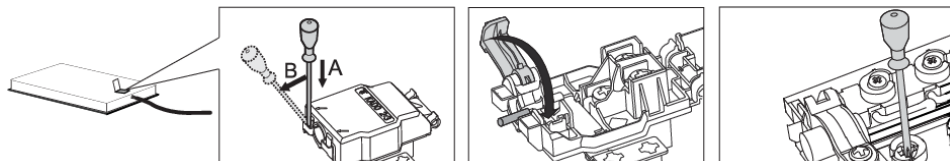

1. Open the cover of the connection terminal box.
2. Connect the wires according to your type of appliance.
3. Run the power cord through a cord strain relief (clamp) that protects the cable from being pulled out.

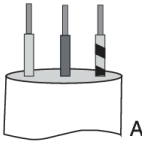
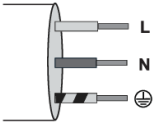
Connection diagram	Connecting the power cord to the power mains (appliance with a power cord)	
 <p>220-240V ~ / 50-60Hz</p> <p>PE ⊗ L1 ⊗ N</p> <p>⊕</p>	<p>1 x 16 A</p> <p>220-240 V 50-60 Hz</p>  <p>A</p>	<p>L = brown N = blue</p> <p>⊕ = yellow and green</p>  <p>L N ⊕</p>
<p>The circuit should be fitted with a fuse of at least 16 A. Appliances with a width of 30 centimetres (two cooking zones) only allow single-phase connection. The cross-sectional area of the power cord core should be at least 1.5 mm<sup>2</sup>!</p>	<p><b>Single-phase connection</b></p> <p>Connect the appliance as shown in Diagram A. If your power mains do not allow a 16 A fuse, the appliance power should be decreased or limited accordingly. See chapter User Settings.</p>	



# 5. Appliance description



## INFORMATION!

Appliance functions and equipment depend on the model.

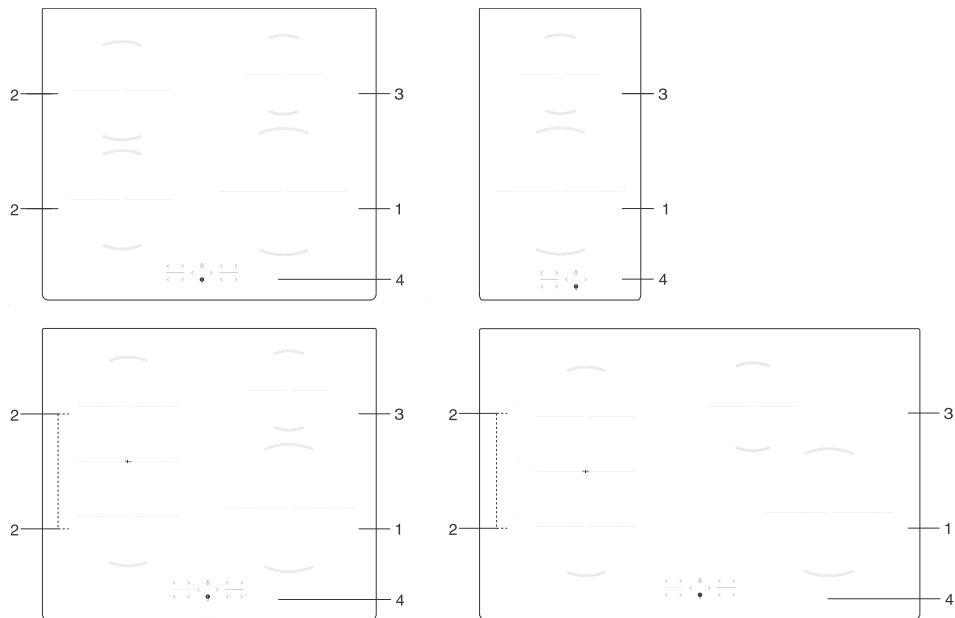

1. Induction cooking zone ø 230 mm
2. Induction cooking zone ø 180 mm
3. Induction cooking zone ø 145 mm
4. Cooking hob control module

## 5.1 Before first use

Clean the cooking surface using a damp cloth and some mild washing-up liquid.

During initial use, the characteristic "new appliance smell" may appear; it will gradually disappear.

# 6. Operating the cooking hob

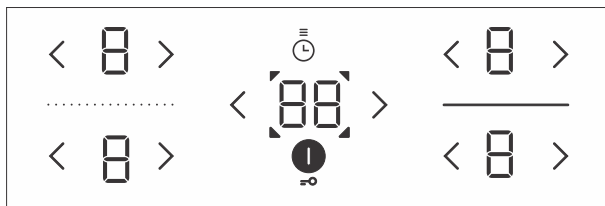

## 6.1 Control unit

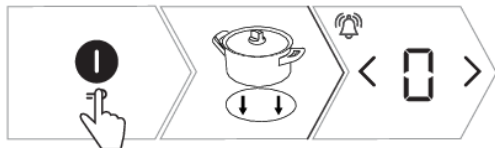

	Hob on/off key	Touch the relevant key to switch the hob on or off.
	Lock/child lock	Locks/unlocks the cooking hob controls
	Power increase key	<p>Powers on the selected cooking zone or increases operating power:</p> <ul style="list-style-type: none"> <li>• touch to switch on the selected cooking zone to power level 9</li> <li>• touch once (tap) to increase the power level by one level</li> <li>• long-press to set or increase the power level faster</li> </ul>
	Power decrease key	<p>Power off the selected cooking zone or decrease operating power:</p> <ul style="list-style-type: none"> <li>• touch to switch on the selected cooking zone to power level 4</li> <li>• touch once (tap) to decrease the power level by one level</li> <li>• long-press to set or decrease the power level faster</li> <li>• long-press or press multiple times to switch off the selected cooking zone</li> </ul>
	Power level display	Indicates the current power level setting for the cooking zone
	Time functions	<p>Setting the timer:</p> <ul style="list-style-type: none"> <li>• countdown timer (minute minder) for the entire cooking hob; does not power off the cooking zone</li> <li>• shut-off timer for respective cooking zones; when the time expires, the cooking zone is powered off</li> </ul>
	Timer function indicator	Indicates the selected cooking zone

## 6.2 Powering on the induction cooking hob



1. Touch  to power on the induction hob.
2. Place the cookware onto the selected cooking zone.
3.  appears on all cooking zone displays; a short beep is emitted.







### INFORMATION!

If no cooking zone is switched on in 10 seconds, the induction hob will power off.



## 6.3 Switching on the cooking zones



1. Touch the  key for the selected cooking zone. The selected display unit will flash.
2. Use the  or  key to set the power level for the selected cooking zone.
3. The cooking zone remains activated.
4. If the hob does not recognize any pan on the selected cooking zone, the symbol  appears. If you do not place a pan on the selected cooking zone within 2 minutes, the cooking zone will automatically switch off.



### INFORMATION!

During operation, power level for the selected cooking zone can be adjusted using the  or  key.

## 6.4 Bridged cooking zone

(depending on the model)

- Some models allow combining two cooking zones on the left-hand side into a single large connected cooking zone. Thus, a large oval pan or a griddle can be placed on the combined cooking field. The pan has to be large enough to cover the centres of the upper and lower cooking zone.
- Maximum pan size: 40 x 25 cm. For even heat distribution, we recommend using a heavy-bottom baking dish or pan. During cooking, the dish or pan will heat up. Be careful to prevent burns.
- When placing the baking dish on the hob, make sure it does not cover the control module.

**INFORMATION!**

The pan should always cover the centre of the cooking zone!

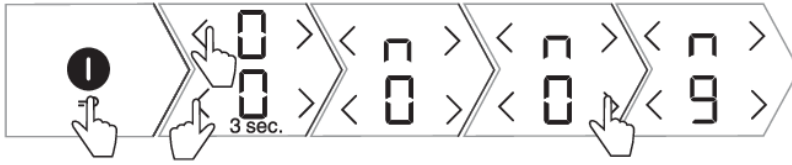

- |  |
|--|
| 1. Power on the induction hob.   |
| 2. Simultaneously touch < and > and hold them for 3 seconds. The sign □ will appear on the display unit for the rear field to indicate that the two cooking zones are bridged. |
| 3. Set the desired cooking power for the bridged cooking zone.   |
| 4. Set the power level of the combined cooking zone to "0". The sign □ will disappear and heating will be switched off.  |
| 5. Both cooking zones will operate independently.  |

## 6.5 Automatic rapid heating

All cooking zones are fitted with a special mechanism that sets the cooking power to maximum at the start of the cooking process, regardless of the actual power setting. After a while, the cooking zone power switches back to the initially set level. Automatic rapid heating can be activated on every cooking zone for any cooking power level except for level "9" and "P".

**INFORMATION!**

The automatic rapid heating function is suitable for dishes that have to be heated up at maximum power first, and then cooked for a longer period of time at a lower power level without the need for constant supervision.

The automatic rapid heating function is not suitable for braising, frying, or sautéing, food that requires frequent turning, basting, or mixing, or food that has to boil for a longer period of time in a pressure cooker.

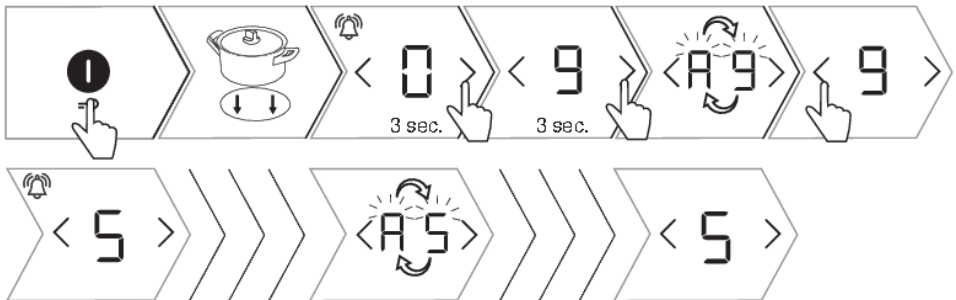

- |   |
|---|
| 1. Power on the induction hob.                      |
| 2. Place the cookware on the selected cooking zone. |

Table continued from last page

3. Press the > key and hold it for approximately 3 seconds until you hear a short beep. <b>9</b> and <b>9</b> will flash alternately on the display.
4. Press < or > to set the final power level for the automatic rapid heating function. Five seconds after you have selected the power level, the function is confirmed with a short beep. If you set the final power level to <b>9</b> or <b>0</b> the function is disabled.
5. <b>9</b> and selected power level will alternate on the power level display.
6. When the automatic rapid heating time expires, the cooking zone automatically switches to the selected level which will then be continuously displayed.
7. To switch off the automatic rapid heating function, simultaneously press < and > or if you decrease or increase the power level on the selected cooking zone. Then, you can set the new power level.

### Automatic rapid heating table

Power level	1	2	3	4	5	6	7	8
Automatic rapid heating time (sec)	40	70	120	180	260	430	120	195

## 6.6 Power Boost

(depending on the model)

For rapid cooking, power boost can be activated on the cooking zones. This will allow you to rapidly heat large amounts of food using extra power. The power boost is active for no more than 10 minutes; then, the power level is automatically decreased to 9. If the cooking hob is not too hot, the power boost can be reactivated for 10 minutes after it is switched off. To avoid overheating, the electronic control function may automatically switch off the Power Boost earlier and decrease the power level to 9.

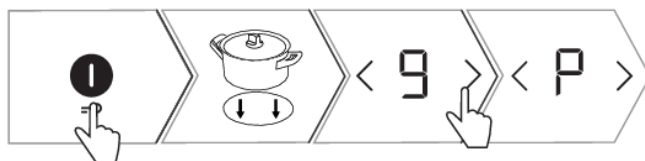

1. Power on the induction hob.
2. Place the cookware on the selected cooking zone.
3. Set the power level to <b>9</b> , then press the > key.
4. <b>P</b> will appear on the display. The function is activated.
5. Press < to deactivate the function. Power boost will be deactivated, and operating power will return to level <b>9</b> .
6. Press < multiple times to decrease power to the desired level.





## 6.7 Child lock / lock

Induction hob controls can be locked to prevent the hob from being powered on inadvertently.

### **INFORMATION!**

The cooking hob has to be switched off or in the standby mode.



1. Touch the  key and hold it for 3 seconds.  will appear on the cooking zone power level displays.
2.  will appear on the timer function display.
3. The induction hob is locked.
4. After 5 seconds, the induction cooking hob will automatically switch off to standby mode.
5. Touch the  key and hold it for 3 seconds. The hob is now unlocked.

### **INFORMATION!**

Note: If the child lock/lock function is activated in the user settings mode (see chapter User Settings Mode, Parameter  ), then the hob will be automatically locked every time it is switched off.

### **INFORMATION!**

Activate the lock function before cleaning to prevent the induction hob from being inadvertently switched on.

## 6.8 Time functions

This function allows two operating modes:

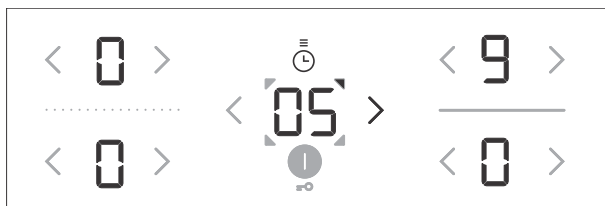





1. The **countdown timer** (minute minder) applies to the entire induction hob. With this function, the hob only beeps when the set time expires.

Table continued from last page

**2. Program timer** applies to the selected cooking zone. A separate timer can be set for each cooking zone. When the set time expires, the cooking zone is automatically switched off.

## 1 Countdown timer

The countdown timer (minute minder) operates independently, and it is not related to the operation of any cooking zone. When the countdown timer is set, it will continue to count down the time even if you power off the induction cooking hob. The minute minder can only be switched off when the induction cooking hob is on.

- |  |
|--|
| 1. Touch the  key to activate the timer.  will appear on the timer display.  |
| 2. Touch the  or  key to set the time in the range from 1 to 99 minutes. Touch the  key to display the preset time of 90 minutes. |
| 3. When the set time expires, the alarm is sounded.  |
| 4. Press any key to acknowledge and turn off the alarm.  |
| 5. The countdown timer (minute minder) remains active even when the cooking hob is switched off.   |
| 6. During the last minute of countdown, remaining time will be displayed in seconds.   |















## 2 Program timer

The program timer can be used to set the operating time for the cooking zones on which a power level has already been set.



### INFORMATION!

The switch-off program timer can be set independently for all cooking zones.  
The program timer may only be set for an active cooking zone.

- |  |
|--|
| 1. Touch the  key to activate the timer.  will appear on the timer display.  |
| 2. Touch the  key again and  will start flashing, indicating one or more of the selected cooking zones.  |
| 3. Touch the  or  key to set the time in the range from 1 to 99 minutes. The countdown begins.   |
| 4. After the set time has expired, acoustic signal will be activated, and the cooking zone will be switched off. The value  will flash on the display.  |
| 5. Switch of the alarm by touching any key; alternatively, it will switch off automatically after a certain period of time.  |
| 6. To delete the set time, select timer display by pressing  . The set time will appear,  and  will flash. Touch the  key multiple times to set the value to  , or simultaneously press  and  to immediately reset/delete the set time. |

**INFORMATION!**

Remaining cooking time can be changed at any time during cooking.

## 6.9 Residual heat indicator

The induction hob is also fitted with a residual heat display, **H**. The cooking zone is not heated directly, but only indirectly by the heat radiated back by the pan. As long as the sign **H** is lit up after the hob has been switched off, there is residual heat in the cooking zone, which can be used to keep the food warm or for defrosting. When the **H** sign disappears, the cooking zone may still be hot.

**WARNING!**

Be careful as there is danger of burns!

## 6.10 Maximum cooking time

For safety reasons, the cooking time for each cooking zone on the induction hob is restricted to a maximum duration.

Maximum cooking time depends on the most recently set power level. If the power level is not changed for a long time, the cooking zone will be switched off automatically after the maximum cooking duration is reached (see table below).

Cooking power level	1	2	3	4	5	6	7	8	9	P*
Maximum operating time (h)	8	8	6	6	4	4	2	2	1,5	1,5

\* After 10 minutes, the power level automatically decreases to 9; after 1.5 hours, the cooking zone is switched off.

## 6.11 Overheat protection

The induction hob is fitted with a cooling fan that cools the electronic components during cooking. The fan may operate for a while even after the end of the cooking process.

The hob is also fitted with an overheating protector that protects the electronics from damage. The protector operates at several levels. When the cooking zone temperature gets very high, the cooking power is automatically reduced. If this does not suffice, the cooking zone power continues to decrease, or the safety mechanism switches off the cooking zone completely. When the induction hob cools down, its total power is available again.

## 6.12 Automatic switch off

If the keys are activated for too long during cooking (e.g., due to spilt liquid or an object placed over the sensor keys), all cooking zones will be switched off automatically after 10 seconds.

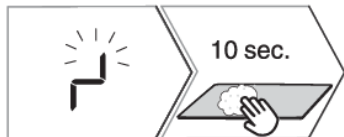







1.  will flash on the display unit.

2. Remove the object or wipe the spilt liquid from the sensor keys within 5 seconds to retain the power level settings. If you do not remove the object or wipe the spilt liquid in 10 seconds, the induction hob will be powered off automatically.

## 6.13 Switching off the cooking zone

To switch off a cooking zone, press the  key to set the value to . To quickly switch off a cooking zone, simultaneously press and hold the  or  key. You will hear a short beep, and  will appear on the display unit.



### INFORMATION!

If the power level of all cooking zones is set to , the cooking hob will switch off automatically after 10 seconds.

## 6.14 Switching off the entire cooking hob

The hob can be switched off at any time by pressing .

# 7. User settings

## Setting the acoustic signal, automatic features, and lock parameters

You can adjust the volume of the acoustic signal, duration of acoustic alarm, total maximum appliance power, and automatic lock settings on the appliance.









**Uo:** Acoustic signal and alarm volume (loudness)

**So:** Acoustic alarm duration

**Lo:** Automatic lock

**Po:** Total maximum power



1. To activate the parameter settings menu, press and hold the key  for 3 seconds while the appliance is switched off.
2. The first parameter  will appear on the timer display, indicating the volume (loudness) of acoustic signals.
3. Press the timer setting keys  or  to adjust the setting.
4. The parameters are also set for the lower left cooking zone.
5. The currently set parameter value will appear on the left-hand side cooking zone power level displays. The value can be adjusted by pressing the  or  key for the cooking zone.
6. All parameters can be confirmed and stored by pressing and holding the  key for 2 seconds.
7. A short beep will be emitted.
8. If you do not wish to store the new parameter settings, close the user settings mode by pressing the  key; alternatively, the user settings mode will close automatically after 2 minutes.

### Acoustic signal and alarm volume (loudness) "Uo"

	The following values can be set:
	<b>0</b> on the display = off (does not apply to alarm and error acoustic signal)
	<b>1</b> on the display = minimum volume
	<b>2</b> on the display = medium volume
	<b>3</b> on the display = maximum volume (default)
A short acoustic signal will be sounded upon every change, with the newly set volume.	

### Acoustic alarm duration "So"

	The following values can be set:
	<b>0.5</b> on the display = 5 seconds
	<b>1</b> on the display = 1 minute
	<b>2</b> on the display = 2 minutes (default)

### Child safety lock "Lo"

	If the automatic lock function is activated in the user settings mode, the cooking hob will be automatically locked every time it is switched off.
	<b>0</b> on the display = off (default)
	<b>1</b> on the display = on

### Power management

(depending on the model)

The induction hob allows you to adjust the power consumption for optimum operation and excellent cooking experience. This means you can control the distribution of operating power across respective cooking zones.

### Total maximum power "Po"

This menu can only be accessed within the first 2 minutes after the hob is connected to the power mains.

You cannot adjust other settings during this time.

	The following total maximum power settings are possible depending on the capabilities of the electrical installation in your home:
	<b>7.2</b> on the display unit = 7.2kW = 2 x 16 A
	<b>6.0</b> on the display unit = 6.0kW = 2 x 16 A
	<b>3.6</b> on the display = 3,6 kW = 1 x 16 A
	<b>2.8</b> on the display = 2,8 kW = 1 x 13 A
	<b>2.3</b> on the display = 2,3 kW = 1 x 10 A



### INFORMATION!

If the power level is limited, the settings and the resulting cooking power can be limited as well. The appliance is fitted with a power management system that makes sure the effect of power limiting is minimal.

## 8. Tips and hints

### 8.1 Cooking hob (conventional or glass ceramic)

- The hob is resistant to temperature changes.
- Using the cooking hob surface as a storage area may result in scratches or other damage to it.
- Do not use the glass ceramic hob if it is cracked or broken. If a sharp object falls on the hob, the hob may break. The consequences of such occurrence may be visible immediately or only after a while.
- If any visible crack appears in the hob, immediately cut off the power supply to the appliance.
- Make sure the cooking zone and the cookware bottom is clean and dry. This will allow better conduction of heat and prevent any damage to the heating surface.
- Do not place empty cookware on the cooking zone, as this may result in damage.



#### **WARNING!**

If sugar or food with high sugar content is spilled over a hot glass ceramic hob, immediately wipe the hob or remove the sugar with a scraper, even if the cooking zone is still hot. This will prevent any damage to the glass ceramic surface.

Do not use detergents and other cleaners to clean a hot glass ceramic hob as this could damage the surface.

### 8.2 Induction cooking zone operating principle

Cooking on an induction hob differs from cooking on traditional appliances. Induction hob uses magnetic field for generating heat and cooking. This means that not all types of cookware can be used on an induction hob.

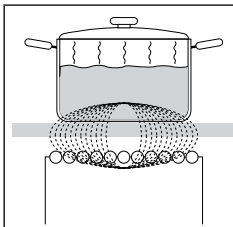

The cooking hob is fitted with highly efficient induction cooking zones. The heat is generated directly in the bottom of the pan where it is needed the most. This avoids any losses through the glass ceramic surface. Power consumption is considerably lower than in conventional cooking zones with radiation heaters.

The glass ceramic cooking zone is not heated directly, but only indirectly with the heat radiated back by the pan. After the cooking zone is switched off, this residual heat is indicated by  $H$ .

In induction cooking zones, heating is made possible by the induction coil installed under the glass ceramic surface. The coil induces a magnetic field which generates eddy currents in the bottom of a ferromagnetic pan, which in turn heats the pan.

The induction will work correctly if you use suitable cookware.

## 8.3 Induction cookware

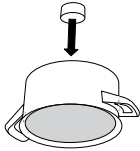
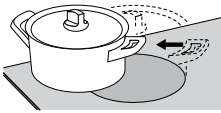
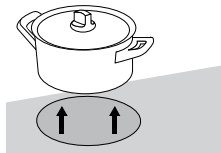
	<p>The magnet test: Use a small magnet to check whether the pan or pot bottom is ferromagnetic. If the magnet sticks to the bottom of the pan, then it is suitable for an induction cooker.</p>
	<p>Make sure the pot or pan is in the middle of the cooking zone</p>
	<p>For best cooking results, the ferromagnetic area on the cookware bottom should match the size of the cooking zone. If the cooking zone does not recognize the pan, try placing it on a different cooking zone with a smaller diameter.</p>

Suitable cookware	Unsuitable cookware
steel	glass
enamel-coated steel	alloy steel with copper bottom
cast iron	alloy steel with aluminium bottom

- When using a pressure cooker, keep an eye on it until the right pressure is reached. First, set the cooking zone to maximum power; then, following the pressure cooker manufacturer's instructions, decrease the cooking power when appropriate.
- Make sure there is enough liquid in the pressure cooker, or any other pot or pan. Due to overheating, using an empty pot on the cooking zone may result in damage to both the pot and the cooking zone.
- Some cookware does not have a fully ferromagnetic bottom. In such case, only the magnetic part will heat up, while the rest of the bottom will remain cool.
- When using special cookware, observe the manufacturer's instructions.

Cooking zone	Minimum pan bottom diameter
Ø 145 mm	Ø 90 mm
Ø 180 mm	Ø 110 mm
Ø 230 mm	Ø 110 mm

Pan bottom has to be flat.

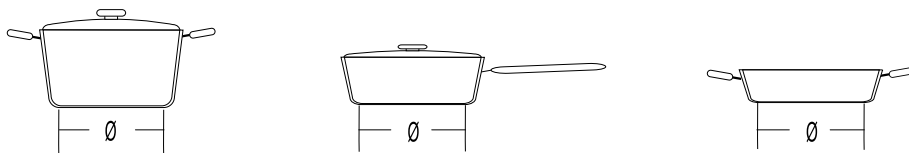

## 8.4 Energy saving tips

- When purchasing cookware, consider that the diameter indicated on the pan usually pertains to the upper edge or the lid, which is normally larger than the diameter of the pan bottom.
- If a dish takes a long time to cook, use a pressure cooker. Make sure there is always sufficient liquid in the pressure cooker. If an empty cooker is placed on the cooking hob, it may overheat which in turn may lead to damage to both the pot and the cooking zone.
- Whenever possible, cover the pot or pan with a suitably sized lid. Use cookware that fits the amount of food you are cooking. Cooking in a large partly full pot will consume much more energy.
- Even if there is no pot or pan on the cooking zone or if the pan used has a diameter that is smaller than the diameter of the cooking zone, there will be no losses of energy.
- If the pan is much smaller than the cooking zone, there is a possibility that it will not be recognized by the cooking zone. When the cooking zone is activated, the sign  $\sqcup$  and the selected power level will flash alternately on the cooking power display. If a suitable pan is placed on the induction cooking zone within the next minute, the hob will recognize it and switch on with the selected cooking power. As soon as the pan is removed from the cooking zone, the power supply is cut off.
- If a smaller pan or pot is placed on the cooking zone and it is recognized, the hob will only use as much power as necessary given the pan size.

## 9. Cleaning and maintenance

After each use, wait for the glass ceramic surface to cool down and clean it. Otherwise, all remaining impurities will burn onto the hot surface the next time you use the hob.

For regular maintenance of the glass ceramic hob, use special care products that create a protective film on the surface to prevent the dirt from sticking onto it.

Before each use of the glass ceramic surface, wipe off the dust or any other impurities that could scratch the surface, from both the hob and the pan bottom.

### **INFORMATION!**

Steel wool, coarse cleaning sponges, and abrasive powders may scratch the surface. The surface may also be damaged by aggressive spray cleaners and unsuitable liquid cleaners.

Signage may be worn when using aggressive or abrasive cleaners or cookware with coarse or damaged bottom.

Use a damp soft cloth to remove minor impurities. Then, wipe the surface dry.

Remove water stains with a mild solution of vinegar. However, do not use this solution to wipe the frame (only with some models) as it may lose its sheen. Do not use aggressive spray cleaners or descaling agents.

Use special glass ceramic cleaners for stubborn dirt. Observe the manufacturer's instructions. Be sure to thoroughly remove any cleaner residues after the cleaning process as they may damage the glass ceramic surface when the cooking zones heat up.

Remove stubborn and burnt residues with a scraper. Be careful when handling the scraper to prevent injury.

### **INFORMATION!**

The scraper is not included in appliance equipment.

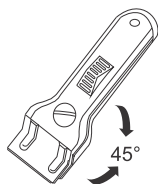

### **INFORMATION!**

Only use the scraper when dirt cannot be removed with a wet cloth or special cleaners for glass ceramic surfaces.

Hold the scraper at the correct angle (45° to 60°). Gently press the scraper against the glass and slide it over the signage to remove the dirt. Make sure the plastic handle of the scraper (in some models) does not come into contact with a hot cooking zone.

### **INFORMATION!**

**Do not press the scraper perpendicularly against the glass and do not scratch the hob surface with its tip or blade.**

Immediately remove any sugar or sugar-laden food from the glass ceramic hob using a scraper, even if the hob is still hot, as sugar may permanently damage the glass ceramic surface.

## 10. Problems and errors

**During the warranty period, only a service centre authorized by the manufacturer may carry out any repairs.**

Before making any repairs, make sure the appliance is disconnected from the power mains either by removing the fuse or by disconnecting the power plug from the wall outlet.

Any unauthorized repairs of the appliance may result in electric shock and short circuit hazard; therefore, do not perform them. Leave such work to an expert or a service technician.

In case of minor problems with appliance operation, check this manual to see if you can fix the problem yourself.

Save the instructions for future reference and pass them on to any subsequent owners or users of the appliance.

Following are some troubleshooting tips.

<b>Problem/error</b>	<b>Cause</b>
<b>The main fuse in your home trips often.</b>	Call a service technician.
<b>Continuous beep and display </b>	Water spilt over the sensor surface, or an object placed over the sensors. Wipe the sensor surface.
<b>F on the display</b>	This indicates that there has been an error during operation. Disconnect the appliance from the power mains for a few minutes (undo the fuse or switch off the main switch); then, reconnect the appliance and switch it on.

If the problems persist despite observing the above advice, call an authorized service technician. Repair or any warranty claim resulting from incorrect connection or use of the appliance shall not be covered by the warranty. In this case, the user will cover the cost of repair.



### **WARNING!**

Before the repair, disconnect the appliance from the power mains (by removing the fuse or by removing the plug from the wall outlet).



## 10.1 Noises during induction cooking

Noises and sounds	Cause	Solution
<b>Inductiongenerated operating noise</b>	Induction technology is based on the properties of some metals under electromagnetic effect. It results in so-called eddy currents that force the molecules to oscillate. These oscillations (vibrations) are transformed into heat. Depending on the type of metal, this could result in quiet noises.	This is normal and it is not a result of any malfunction.
<b>Transformer-like buzz</b>	Occurs when cooking at a high power level. The reason for this is the amount of energy transferred from the cooking hob to the pot or pan.	This noise will disappear or weaken when you reduce the power level.
<b>Vibration and crackling of the cookware</b>	This noise appears in cookware (pots or pans) made of different materials.	It results from vibrations along the adjacent surfaces of different material layers. This noise depends on the cookware. It can vary depending on the amount and type of food being cooked.
<b>Fan noise</b>	Correct operation of induction electronic components requires temperature control. Therefore, the cooking hob is fitted with a fan that cools the electronics depending on the sensed temperature.	The fan may operate even after the cooking hob has been switched off, if the temperature remains too high.

## 11. Technical data

(depending on the model)



- |                  |                                     |
|------------------|-------------------------------------|
| A. Serial number | E. Trademark                        |
| B. Model         | F. Technical data                   |
| C. Type          | G. QR code                          |
| D. Code          | H. Compliance indications / symbols |

**The rating plate with basic information on the appliance is located on the bottom side of the cooking hob. Information on appliance type and model can be found on the warranty sheet.**

## 12. Disposal



Our product packaging is made of environmentally friendly materials that can be recycled, disposed of, or destroyed without any hazard to the environment. To this end, packaging materials are labelled appropriately.

**The symbol** on the product or its packaging indicates that the product should not be treated as normal household waste. Take the product to an authorized collection centre for waste electric and electronic equipment processing.

Correct **disposal** of the product will help prevent any negative effects on the environment and health of people, which could occur in case of incorrect product removal. For detailed information on removal and processing of the product, please contact the relevant municipal body in charge of waste management, your waste disposal service, or the store where you bought the product.

We reserve the right to any changes and errors in the instructions for use.

# **gorenje**

Made in Slovenia



899547-a13

