



INSTRUCTIONS FOR USE

FREEZER

EN

FN23841

FN23844

Contents

Introduction	3	Operating the appliance	16
Welcome to our growing ASKO family!	3	Switching the appliance on/off	16
Important notes and precautions	4	Adjusting the temperature in the appliance	16
Before using the appliance for the first time	4	Intensive freezing (super freeze) function	17
Important safety instructions	4	Eco function	17
Important information on the use of appliance	6	High temperature alarm	18
Installation and connection	8	Open door alarm	18
Selecting the location	8	Storing and freezing food	19
Connecting the appliance	10	Recommended distribution	19
Side-by-Side kit	10	Avoid contamination of food	19
Before using the appliance for the first time	11	Freezing and storing foods in the freezer	19
Before you use the appliance for the first time	11	Thawing frozen food	21
Energy-saving advice	11	Maintenance	22
Reversing the door opening direction	12	Defrosting the appliance	22
Description of the appliance	15	Cleaning the appliance	22
AdaptTech	15	Faults table	24
		Environmental aspects	26
		Disposal of packaging and appliance	26

Welcome to our growing ASKO family!

We are proud of our appliances. We hope that this appliance will be an appreciated and dependable aid for many years to come.

Please read the operating instructions before use. They include general tips, information about the settings and adjustments you can make, and the best way to take care of your appliance.

WARNING!

Read the safety instructions before using the appliance!

Read these instructions thoroughly before you first use the appliance, and keep the instructions for future use.

Link to the EU EPREL database

Information about your product can be found at www.asko.com/energylabel, where you will also find a link to the European Product Database for Energy Labelling, EPREL. Or else visit <https://eprel.ec.europa.eu> directly. Follow the instructions to search by model name (see the information on the serial number plate).

The following symbols are used throughout the manual and they have the following meanings:

INFORMATION!

Information, advice, tip, or recommendation

WARNING!

Warning – general danger

DANGER OF FIRE!

Warning; risk of fire / flammable materials

Important notes and precautions

Before using the appliance for the first time

Before connecting the appliance to the power mains, please read carefully the instructions for use which describe the appliance and its correct and safe use. The instructions apply to several appliance types/models; thus, settings or equipment may be described herein which is not available in your appliance. We recommend saving this instruction manual for future reference and attach it to the appliance if it is sold in the future.

Check for any damage or irregularities on your appliance. If you find your appliance is damaged, notify the retailer from which you have purchased the appliance.

Before connecting the appliance to the power mains, let the appliance rest in a vertical position for a minimum of 2 hours. This will reduce the possibility of operation faults due to the effect of transport on the cooling system.

Important safety instructions

 **DANGER OF FIRE!**

WARNING! Risk of fire/flammable materials.

The appliance must be connected to the power mains and grounded in compliance with the effective standards and regulations.

WARNING! Do not locate multiple portable socket-outlets or portable power supplies at the rear of the appliance.

Before cleaning the appliance, unplug it from the power mains (unplug the power cord from the wall outlet).

 **ELECTRIC SHOCK!**

WARNING! If the supply cord is damaged, it must be replaced by the manufacturer, its service agent or similarly qualified persons in order to avoid a hazard.

 **ELECTRIC SHOCK!**

WARNING! When positioning the appliance, ensure the supply cord is not trapped or damaged.

 **ELECTRIC SHOCK!**

If LED lighting does not work, call a service technician. Do not attempt a repair of the LED lighting yourself, as there is danger of contact with high voltage!

Important notes and precautions

WARNING!

WARNING! Do not use electrical appliances inside the food storage compartments of the appliance, unless they are of the type recommended by the manufacturer.

WARNING!

WARNING! Do not use mechanical devices or other means to accelerate the defrosting process, other than those recommended by the manufacturer.

WARNING!

WARNING! To avoid any hazard resulting from poor stability of the appliance, make sure it is installed as instructed.

Freeze burn hazard

To avoid freeze burn, never put frozen food in your mouth and do not touch frozen food.

Safety of children and vulnerable persons

The appliance is not intended for use by persons (including children) with reduced physical, sensory or mental capabilities, or lack of experience and knowledge, unless they have been given supervision or instruction concerning use of the appliance by a person responsible for their safety.

Children should be supervised to ensure that they do not play with the appliance.

Cleaning and user maintenance shall not be made by children without supervision.

Remove the packaging intended to protect the appliance or particular parts during transport and keep it outside the reach of children. It presents danger of injury or suffocation.

Important notes and precautions

When removing a used appliance, disconnect the power cord, remove the door, and leave the shelves in the appliance. This will prevent children from locking themselves in the appliance.

For European markets only

This appliance can be used by children aged from 8 years and above and persons with reduced physical, sensory or mental capabilities or lack of experience and knowledge if they have been given supervision or instruction concerning use of the appliance in a safe way and understand the hazards involved.

Children shall not play with the appliance.

Cleaning and user maintenance shall not be made by children without supervision.

Children aged from 3 to 8 years are allowed to load and unload refrigerating appliances.

Warning regarding the refrigerant

The appliance contains a small amount of an environmentally friendly yet flammable gas R600a. Make sure that no parts of the cooling system are damaged. A gas leak is not hazardous to the environment, but it could cause eye injury or fire.

In case of a gas leak, ventilate the room thoroughly, disconnect the appliance from the power mains, and call a service technician.

Important information on the use of appliance

WARNING! This appliance is intended to be used in household and similar applications such as:

- staff kitchen areas in shops, offices and other working environments;
- farm houses and by clients in hotels, motels and other residential type environments;
- bed and breakfast type environments;

Important notes and precautions

- catering and similar non-retail applications.

WARNING!

WARNING! Keep ventilation openings, in the appliance enclosure or in the built-in structure, clear of obstruction.

The appliance may not be used outdoors and it may not be exposed to rain.

Do not store explosive substances such as aerosol cans with a flammable propellant in this appliance.

If the appliance will be out of use for an extended period of time, switch it off using the relevant button, and unplug it from the power mains. Empty the appliance, defrost it, clean it, and leave the door ajar.

In case of an error or power supply failure, do not open the freezer compartment unless the freezer has not operated for over 16 hours. After this period, use the frozen food or provide sufficient cooling (e.g. a replacement appliance).

Technical information on the appliance

Rating plate can be found in the appliance interior. It indicates data on voltage, gross and net volume, type and amount of refrigerant, and information on the climate classes.

If the language on the rating plate is not the language of your choice or the language of your country, replace it with the one supplied.

WARNING!

WARNING! Do not damage the refrigerant circuit.

Installation and connection

Selecting the location

- Place the appliance in a dry and well aired room. The permitted ambient temperature range for the appliance depends on the appliance's climate class, which is shown on the type plate.
- Do not place the appliance near a source of heat, such as a gas cooker, radiator or boiler, etc., and do not expose it to direct sunlight.

Description	Class	Ambient temperature range °C	Relative humidity
Extended temperate	SN	+10 to +32	≤75%
Temperate	N	+16 to +32	
Subtropical	ST	+16 to +38	
Tropical	T	+16 to +43	

INFORMATION!

This appliance is not intended to be used as a build-in appliance.

WARNING!

Do not place the appliance in a room where the temperature can fall below 5 °C: the appliance may not work properly or become defective!

WARNING!

The appliance is not suitable for outdoor use and it may not be exposed to rain.

- The appliance must be placed at a distance of at least 5 cm from an electrical or gas cooker and at least 30 cm from a radiator or heater. An insulation panel must be fitted when these distances cannot be kept.
- The appliance must be placed at a distance of about 5 cm from the wall, back and sides of a cupboard. A kitchen cupboard above the refrigerator must have a gap of at least 5 cm between the back of the cupboard and the wall. This is needed to make sure that there is sufficient cooling air for the condenser.
- The plug of the installed appliance must remain accessible!

WARNING!

Place the appliance in a room with a sufficient volume of air. The room must have a volume of at least 1 m³ of air for every 8 grams of refrigerant. The quantity of refrigerant is shown on the type plate on the inside of the appliance.

- The kitchen unit in which the appliance is to be built in must have an opening of at least 200 cm² in its base to allow sufficient air to circulate.
- The appliance's air outlet is at the top. Make sure that the outlet is not blocked. Blocking the outlet can result in damage to the appliance.

Installation and connection

Appliance installation should be carried out by at least two persons to avoid any personal injury or damage to the appliance.



- The appliance must stand level or tilted slightly to the back. It should be stable and placed on a solid base. At the front, the appliance is fitted with two adjustable feet that can be used to level the appliance. At the rear side, casters allow for easier installation of the appliance (only with some models).

- After you have levelled the appliance using the adjustable feet, adjust the additional foot for extra stability of the appliance.
- The appliance is intended for free-standing installation. To reach the rated/minimum power consumption, always provide 50 mm of clearance between the wall and the back of the appliance, and above the appliance. Also allow adequate air circulation on either side of the appliance and above it.
- The appliance can also be placed adjacent to or between kitchen cabinets or cupboards, or adjacent to a wall. In case of such placement, the appliance will operate flawlessly; however, power consumption could increase. Observe the minimum clearance above and behind the appliance, as indicated in the figure.
- Take into account the space or clearance required to open the appliance door, in order to allow the drawers and shelves to be pulled out or removed (see installation diagram).

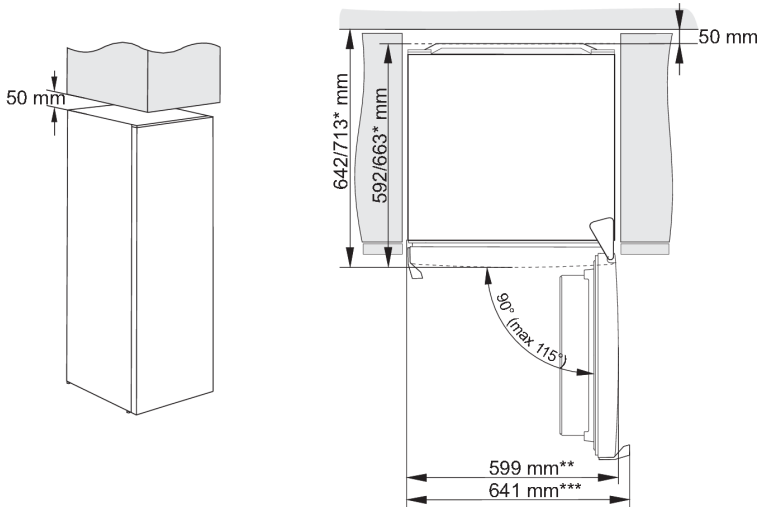

* depending on the model

** model with integrated handle

*** model with external/protruding handle

Note: When placing the appliance on a plinth with a depth of less than 625 mm, it is recommended that you purchase and install a security kit.

Installation and connection

Code for ordering the set: 890399.

Connecting the appliance

- Connect the appliance to the power supply with a plug. The socket must be earthed. The nominal voltage and frequency required for the appliance are shown on the appliance's type plate/label with basic information.
- The appliance must be connected to the mains and earthed in accordance with the prevailing standards and regulations. The appliance can withstand small variations in the mains voltage to a maximum of plus or minus 6%.

WARNING!

When you are not going to use the appliance for a longer period then switch it off with the appropriate key and disconnect it from the mains. Empty, defrost and clean the appliance, and leave the door ajar.

WARNING!

In the event of a defect or power cut, do not open the freezer compartment unless the appliance has been out of operation for more than the hours indicated on the appliance's type plate (temperature rise time). After this time, you must either use the frozen food or make sure that it is properly cooled (for example, by transferring it to another appliance).

Side-by-Side kit

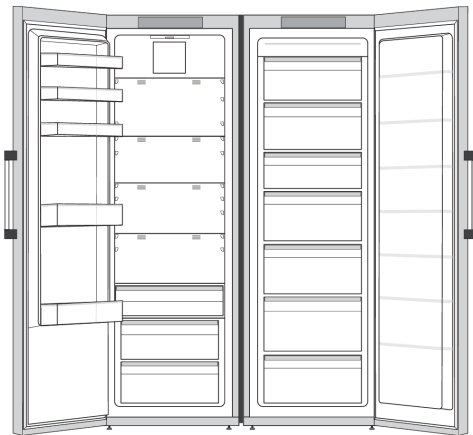

There is a possibility to place two appliances side-by-side.

To ensure the proper fitting and long-lasting operation of two appliances put in side-by-side installment, the dedicated kit should be used. Using the dedicated side-by-side kit will ensure exact alignment, stabilization, and eliminate the possibility of excessive condensate accumulation between adjacent appliances.

For safety reasons, side-by-side kit should only be installed by an authorized service technician!

INFORMATION!

For more informations refer to the local Asko dealer or to the Asko website of your country.

Before using the appliance for the first time

Before you use the appliance for the first time

Do not connect the appliance to the mains until you have carefully read the instructions for the correct and safe use of the appliance. As these instructions are for various types and models, it is possible that the instructions for use refer to settings or parts that are not available on your appliance. We recommend that you keep these instructions for future use. If you sell the appliance, enclose them with the appliance.

Inspect the appliance for damage and/or irregularities. If the appliance is damaged, contact the store that sold you the appliance.

Allow the appliance to stand upright for at least 4 hours before you connect the appliance to the mains. This reduces the risk of malfunctions resulting from transport effects on the refrigerant unit.

Before using the appliance for the first time, the interior and all internal accessories should be cleaned with lukewarm water and a neutral cleaning agent. Wipe the cleaned parts with a cloth with clean water and then dry them thoroughly.

If you use the appliance for the first time, do not put food into the appliance until the temperature has decreased to the set temperature.

Energy-saving advice





- Install the appliance as stated in the instructions for use.
- Do not open the door more than necessary.
- Never cover or obstruct the ventilation openings.
- Replace a door seal that is damaged or no longer seals properly as quickly as possible.
- Store food in well-sealed containers or suitable packaging.
- Allow food to cool to room temperature before you put it in the appliance.
- Defrost food in the refrigerator compartment.
- Defrost a conventional freezer once a layer of about 2 to 3 millimetres of frost or ice has formed on the inside.
- Space the shelves evenly in the refrigerator compartment. Place the food so that the air can circulate freely in the appliance (follow the recommendations for the location of foods enclosed in the instructions).
- The lower the set temperature, the higher the power consumption.
- When the appliance is equipped with a fan then make sure that the ventilation openings are kept clear.

Reversing the door opening direction

The direction in which the appliance door opens can be reversed.

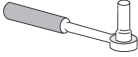
Note: Disconnect the appliance from the power mains before reversing the door opening direction.

Tools required:

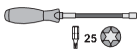
	Socket wrench No. 8,
	Cross-point screwdriver
	Flat screwdriver
	Spanner No. 8
	Torx T25

Note:

- If the appliance has to be tilted to allow access to parts on the bottom, ask another person for assistance or gently place the appliance on some soft padding to prevent damaging it. To reverse the opening direction, proceed as follows.

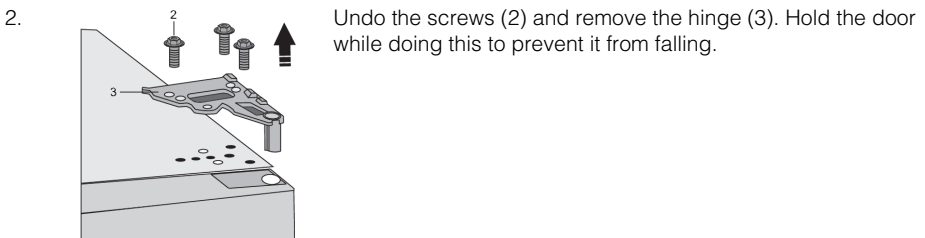
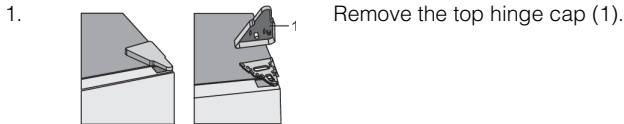

Reversing the door opening direction

3.

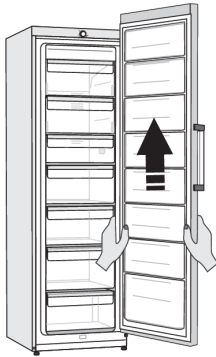

Remove the door from the bottom hinge by carefully lifting the door straight up. Lay the door onto a smooth surface.

4.

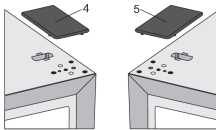

Take the (right) cap/cover (4) from the bag and place it on the spot from which the top hinge was removed. Remove and save the cap/cover from the other side (5) to which the hinge will be relocated.

5.

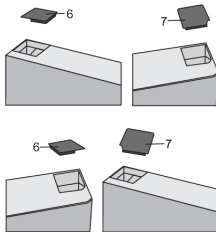

Remove the cap (6) from the left side of the door. Then, remove the cap (7) from the right side of the door. Place the cap (7) on the left side of the door and place the cap (6) on the right side of the door.

6.

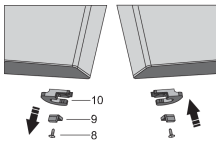

Undo the screw (8) and remove the door retainer (10) and the door stop (9). Then, use a screw (8) to install the door retainer supplied in the bag, and the door stop (9). Keep the door retainer (10) in case you need it later.

7. Tilt the appliance backwards and remove the adjustable foot (11).

8.

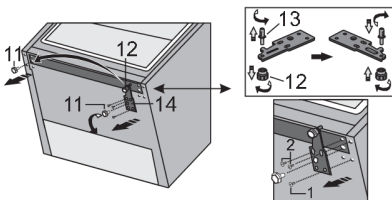

Undo the three screws on the bottom hinge (14) and remove it. Remove the extra foot (12) from the bottom hinge pin (13). Unscrew the pin (13) from the bottom hinge and screw it onto the opposite side of the hinge, complete with the extra foot (12).

Reversing the door opening direction

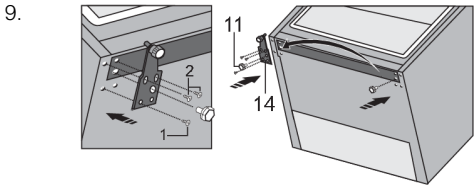

Attach the hinge (14) onto the opposite side using the screws. The screws should be attached in the order shown in the figure below. First, tighten the screw 1, followed by screws 2. Then, screw on the adjustable feet (11).

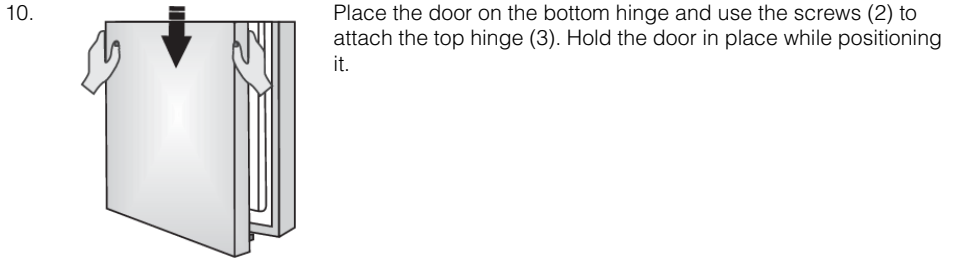

Place the door on the bottom hinge and use the screws (2) to attach the top hinge (3). Hold the door in place while positioning it.

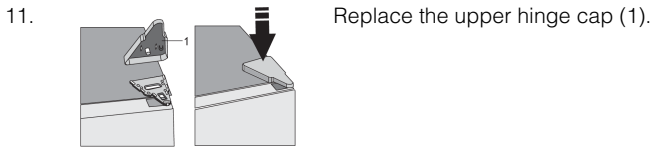
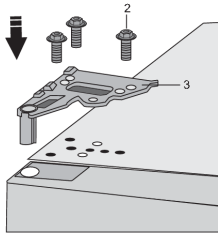

Replace the upper hinge cap (1).

12. Open the door and replace the door racks/shelves. Close the door again.

Replacing the handle

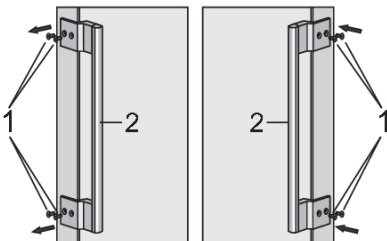

Undo the screws (1) as shown in the figure. Rotate the handle (2) by 180° and replace it on the opposite side. Then, tighten the screws (1).

Description of the appliance

This product contains a light source of energy efficiency class E.

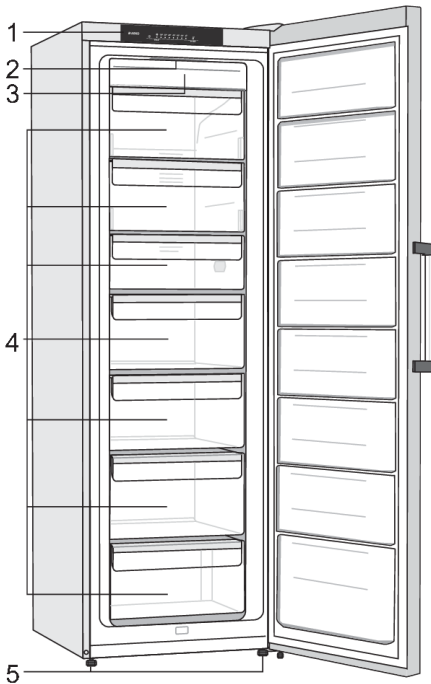

1. Control panel
2. LED lighting of freezer interior
3. NoFrost freezer unit (cooling unit, fan ...)
4. Freezing and storage compartment
5. Foot

NoFrost

With the NoFrost system, you no longer need to defrost the freezer.

AdaptTech

Innovative sensor technology allows adjusting appliance operation to the user's habits or behaviour. Adaptive intelligent system monitors, analyzes, and records on a daily and weekly basis the use of appliance and adapts appliance operation to the perceived patterns. If the appliance is able to anticipate increased frequency of door opening, the appliance will automatically lower the temperature before such time to prevent the increase of food temperature as the door is opened more often. The appliance will also anticipate adding larger amounts of food into the refrigerator or freezer and adapt by cooling or freezing more intensively.

Operating the appliance

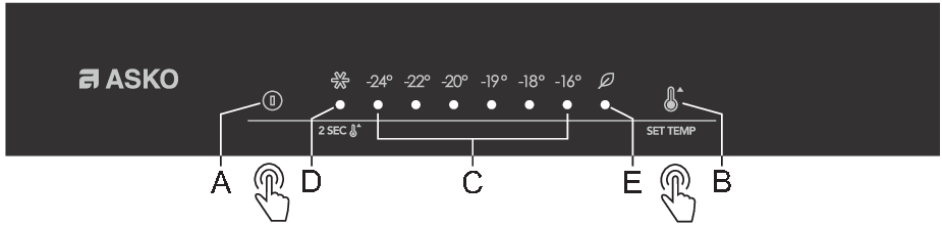

A. **Appliance on/off key**

B. **Temperature and extra functions settings key**

C. **Set temperature display**

The signal light below the set temperature display is lit

D. **Intensive freezing (fast freeze) function indicator**

If intensive freezing (freezer boost) is activated, the light **D** will be lit.

E. **Eco function indicator**

If the **Eco** function is activated, the signal light above the **E** symbol will be lit.

To set the appliance temperature or activate the **Eco** function, press the **B** key successively. The indicator cycles through the settings in a circular manner, from right to left. Three seconds after the key is released, the setting will be stored automatically.

To activate or deactivate **intensive freezing** (freezer boost), press the **B** key and hold it for a few seconds.

Switching the appliance on/off

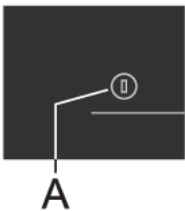

Switching on the appliance: press the **A** key.

Switching off the appliance: Press the **A** key again and hold it for 2 seconds. The appliance will be switched off, but it will remain powered.

Adjusting the temperature in the appliance

❗ INFORMATION!

The factory default setting is the recommended temperature of -18 °C.

After the appliance is switched on, it may take several hours for the set temperature to be reached. Do not place any food into the refrigerator before the temperature drops to the selected setting.

Operating the appliance

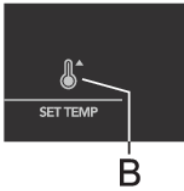

- Set the desired temperature using the **B** key.
- Set the desired temperature by successively pressing the **B** key.
- The indicator cycles through the settings in a circular manner, from right to left.

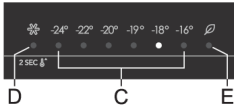

The numbers -16, -18, -19, -20, -22 and -24 indicate the temperature in degrees Celsius (°C) in the appliance.

- We recommend setting the temperature to -18 °C, as this will preserve food quality and freshness longer.
- If the temperature of the room where the appliance is installed is below 16 °C, we recommend setting a temperature lower than -18°C.

Intensive freezing (super freeze) function

Use this setting after switching on the appliance for the first time, before cleaning, or 24 hours before adding a large amount of food.

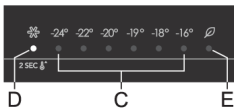

Switching on: To activate intensive freezing, press the **B** key and hold it until the light **D** lights up.

💡 INFORMATION!

When the intensive freezing function is selected, the appliance works at maximum capacity. It may then make more noise for a while.

Switching off: press and hold the **B** key again, until the light **D** goes off. If the intensive freezing function is not deactivated manually, it will be automatically switched off (after approximately two days), and the temperature will return to the most recently set value.

- If there is a power outage while the intensive freezing function is active the function will be restarted once power supply is restored.

Eco function

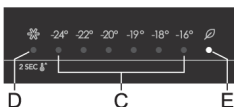

Switching on: To activate the **Eco** function, press the **B** key multiple times until the light **E** lights up. When this function is activated, the appliance operates under optimum settings.

Switching off: To switch off the Eco function, use the **B** key to select the desired temperature.

Operating the appliance

High temperature alarm

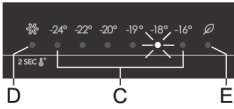

If the temperature inside the appliance is too high, acoustic alarm will be activated (intermittent tone) and the signal light below the set temperature (**C**) will flash.

Every time you switch on the appliance using the **A** key, a 24-hour delay in alarm operation is activated. If the appliance fails to reach a sufficiently low temperature after this period, the alarm will be activated.

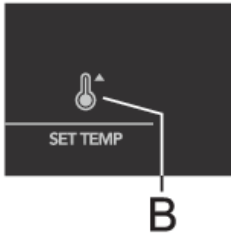

Switching off the alarm:

- To acknowledge and switch off the acoustic alarm, press the **B** key. If the alarm is not switched off, it will be activated every hour for approximately 15 minutes.
- When you press the **B** key again, it will already work as a settings adjustment key.
- The light below the set temperature **C** will flash until the appliance reaches a sufficiently low temperature.

Open door alarm

If the appliance door is open for more than 2 minutes, an acoustic alarm (repetitive beep) will be activated. If the alarm is not switched off manually, it will be sounded for 10 minutes.

To switch off the alarm: to switch off the alarm, close the appliance door.

💡 INFORMATION!

If you switch off the alarm by pressing the **B** key, it will be activated again after 4 minutes if the door is still open.

💡 INFORMATION!

If you leave the door open for more than 10 minutes, then the alarm will stop and the indicator light above the "16°" indicator will start flashing. Appliance operation will switch to safe mode in order to provide sufficient cooling and prevent food spoilage despite the open door.

Recommended distribution

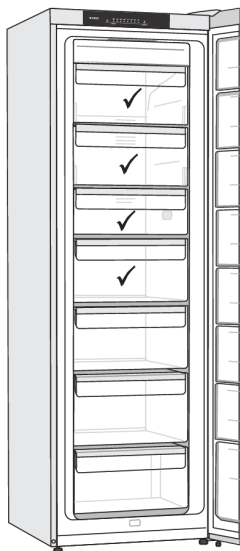

The best location for freezing fresh food is marked with a ✓.

WARNING!

Do not store lettuce, eggs, apples, pears, grapes, peaches, yoghurt, buttermilk, sour cream or mayonnaise in the freezer.

Avoid contamination of food

To avoid contamination of food, please respect the following instructions:

- Opening the door for long periods can cause a significant increase of the temperature in the compartments of the appliance.
- If the refrigerating appliance is left empty for long periods, switch off, defrost, clean, dry, and leave the door open to prevent mould developing within the appliance.

Freezing and storing foods in the freezer

Important recommendations for freezing fresh food

- The maximum quantity of food that you can put in the freezer in one go is stated on the type plate. Putting more than this maximum quantity of food into the freezer will slow the freezing process and reduce the quality. Moreover, this will also harm the quality of frozen food already stored in the freezer.
- Use only good-quality fresh food that is suitable for freezing.
- Allow hot food to cool to room temperature.
- Food needs to be frozen quickly. It is recommended that you use small packs.

Storing and freezing food

- Use air and watertight packaging to prevent the food from drying out and lose its vitamins.
- Note the type and quantity of the food on the packaging, together with the date on which it was frozen.
- Do not allow fresh food to come into contact with frozen food.
- You can remove all the drawers to make use of the total volume of the freezer compartment. Put the food directly on a shelf and on the base of the freezer.

Freezing large quantities of fresh food

- Activate the intensive freezing function 24 hours before you plan to freeze the food.

To make sure the food freezes as quickly as possible, lay out the packages as described below:

- Divide fresh food into smaller packages (1 kg). Place two packages against the back wall along the left and right edge of the upper drawer, one package in the middle in front of them (also in the upper drawer), and one package in the middle drawer, against the middle of the back wall.

Important recommendations for storing frozen food

- Follow the manufacturer's instructions for the storage and use of frozen food. Take note of the recommended storage temperature and use-by date stated on the packaging.
- Use only food in undamaged packaging that has been stored at a temperature of -18 °C or lower.
- Do not buy food covered in frost. This indicates that the food has thawed or partially thawed several times and, as a result, is of inferior quality.
- Make sure that the food does not thaw during transport. An increase in its temperature will shorten the storage life and harm the quality of the food.

Recommended storage times of frozen food in the freezer

Type of food	Storage life
Fruit, beef	from 10 to 12 months
Vegetables, veal, poultry	from 8 to 10 months
Venison	from 6 to 8 months
Pork	from 4 to 6 months
Finely chopped or minced meat	4 months
Bread, pastas, cooked dishes, whitefish	3 months
Offal	2 months
Smoked sausage, bluefish	1 month

Thawing frozen food

- Thawing is an important step in storing food preserved by freezing. Food must be thawed in the correct way.
- Suitable methods of thawing food are:
 - in the refrigerator;
 - in cold water;
 - in a microwave or conventional oven with a suitable thaw program.
- Some frozen products can be prepared without needing to thaw them first. The manufacturer will state this on the packaging.
- The food needs to be packed in small portions. In this way the food thaws faster.
- Use partially or completely thawed food as quickly as possible. The bacteria in thawed food are reactivated and the food will spoil rapidly. This applies in particular to fruit, vegetables and ready-made food.
- Do not refreeze partially or completely thawed food.

Maintenance

Defrosting the appliance

Defrosting of the NoFrost freezer

The NoFrost freezer defrosts automatically. Any frost deposits will then disappear.

Any ice or frost deposits that nevertheless form in the freezer compartment can be caused by unusual use of the appliance (opening the door too often and too long or poorly sealing door, etc.). The freezer will then need to be defrosted manually.

Manual defrosting of the NoFrost freezer

- A layer of frost could build up on the appliance walls despite the NoFrost feature. This is usually a result of abnormal use of the appliance, such as too frequent door opening, leaving the door open for too long, poor door seal etc.

In such case, the freezer can be defrosted manually, according to the following procedure:

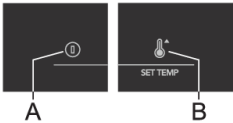

- Simultaneously press the **A** and **B** keys and hold them (10 seconds).
- When the defrosting process is completed, the function will be deactivated automatically.

WARNING!

Do not use any defrosting sprays as they may melt the plastic parts or harm your health.

WARNING!

Do not use a knife or any other sharp object to remove the frost, because you may damage a pipe of the cooling system.

Cleaning the appliance

WARNING!

Switch off the appliance and remove the plug from the socket before you start cleaning it.

WARNING!

Do not use abrasive cleaning agents, as they can damage the surface.

INFORMATION!

Activate the intensive freezing function 24 hours before you plan to clean the freezer.

- Regularly clean the interior of the appliance with lukewarm water. If so required, add a neutral cleaning agent or special refrigerator cleaner to the water. Clean all surfaces with a soft cloth. Wipe the cleaned parts with a cloth with clean water and then dry them thoroughly.

- Do not put parts of the appliance in a dishwasher: this could damage them.
- The condenser unit, located next to the compressor unit on the back of the appliance (only with some models), has to be kept clean, free of dust or other impurities. Occasionally clean it using a soft non-metal brush or a vacuum cleaner.

WARNING!

When you are not going to use the appliance for a longer period then switch it off with the appropriate key and disconnect it from the mains. Empty, defrost and clean the appliance, and leave the door ajar.

Faults table

When you have any doubts about whether your appliance is working properly you should not immediately assume that it is defective. We recommend that you should in any case check the points in the following table.

Problem	Cause/Solution
Appliance is connected to the power mains but it does not work.	<ul style="list-style-type: none"> • Make sure there is voltage in the power outlet and that the appliance is switched on.
Cooling system operates continuously for a long period of time:	<ul style="list-style-type: none"> • Too high environment temperature. • Door opened too frequently or too long. • Door not closed correctly (possible impurities on the seal, misaligned door, damaged seal etc.). • Too much fresh food inserted at once.
Excessive build-up of ice on the back wall of refrigerator interior can be a result of the following:	<ul style="list-style-type: none"> • Door opened too frequently or too long. • Warm food placed in the refrigerator. • Food or containers in contact with the back interior wall of the refrigerator. • Poor door sealing. • If the seal is dirty or damaged, clean or replace it.
Build-up of ice or frost in the freezer interior:	<ul style="list-style-type: none"> • The door has been opened for too long or too frequently. • The door is not properly closed. • The door has a poor seal (the gasket is dirty, the door is not properly aligned, the gasket is damaged etc.). • Manually defrost the appliance.
LED lighting does not work:	<ul style="list-style-type: none"> • If LED lighting does not work, call a service technician. • Do not attempt a repair of the LED lighting yourself, as there is danger of contact with high voltage!
The light above the set temperature display will flash:	<ul style="list-style-type: none"> • Door opened too frequently or too long. • Door not closed correctly (possible impurities on the seal, misaligned door, damaged seal etc.). • An extended power failure. • Too much fresh food inserted at once.
Signal light below the D or E indicator is flashing:	<ul style="list-style-type: none"> • Sensor keys are not responding. Call a service centre for repair. • Until the appliance is repaired by a service technician, the appliance will operate in safe mode. The appliance will automatically maintain the most suitable temperature.
Signal light below the "-16°" indicator is flashing:	<ul style="list-style-type: none"> • Door was open for too long. Close the door.

Table continued from last page

Problem	Cause/Solution
	<ul style="list-style-type: none"> If the door is not open, or if the light below the "-16°" indicator is still flashing after you have closed the door, then there is a door sensor failure. Call a service centre to arrange a repair. The appliance will operate in safe mode until it is repaired. The appliance will automatically maintain the most suitable temperature.
The light below the "-19°" indicator is flashing:	<ul style="list-style-type: none"> Evaporator error. Call a service centre to arrange a repair. The appliance will operate in safe mode until it is repaired. The appliance will automatically maintain the most suitable temperature.
The light below the "-20°" indicator is flashing:	<ul style="list-style-type: none"> Compartment fan failure. Call a service centre for repair. The appliance cannot operate normally. Transfer the food to a cool place and switch off the appliance.
The light below the "-20°" indicator is flashing rapidly:	<ul style="list-style-type: none"> Condenser compartment fan failure. Call a service centre for repair. The appliance cannot operate normally. Transfer the food to a cool place and switch off the appliance.
The light below the "-22°" indicator is flashing:	<ul style="list-style-type: none"> Temperature sensor error or fault. Call a service centre for repair. Until the appliance is repaired by a service technician, the appliance will operate in safe mode. The appliance will automatically maintain the most suitable temperature.

If you are unable to solve the problem then contact the service centre. When you do so, state the type, model and serial number shown on the type plate or label on the inside of the appliance.

Environmental aspects

Disposal of packaging and appliance

This appliance is made from sustainable materials. This appliance must be disposed of in a responsible manner at the end of its service life. Contact the local authorities for information about the method.

INFORMATION!

See also the chapter 'Disposal' in the Safety instructions.

The packaging of the appliance is recyclable. The following materials may have been used:

- Cardboard.
- Polyethylene foil (PE).
- CFC-free polystyrene (hard PS foam).

These materials must be disposed of in a responsible manner and in accordance with government regulations.



The appliance is marked with a crossed out wheeled bin symbol to draw your attention to the requirement for the separate disposal of domestic electrical appliances. This means that the appliance may not be disposed of in unsorted household waste at the end of its service life. The appliance must be taken to a special municipal waste processing location for separated waste or to a dealer who provides this service.

Collecting and disposing of domestic appliances separately avoids detrimental consequences for humans and the environment. This ensures that the materials used to make the appliance can be recovered and that substantial savings in the use of energy and raw materials can be achieved.



Declaration of conformity

We hereby declare that our products conform to the applicable European Directives, Regulations and requirements, as well as all requirements in the standards to which reference is made.

ASKO

Inspired by Scandinavia

The instructions for use can also be found on our website: www.asko.com



885935-a6

