

**Hisense**

EN

GB

IE

# INSTRUCTIONS FOR USE

Induction hob

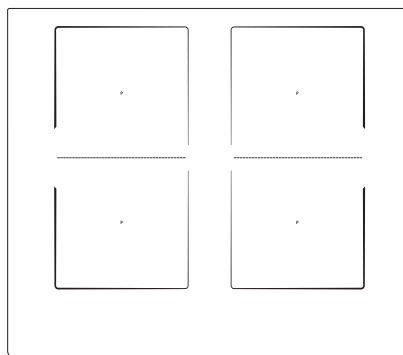

We thank you for your trust and the purchase of our appliance.

This detailed instruction manual is supplied to make the use of this product easier. The instructions should allow you to learn about your new appliance as quickly as possible.

Make sure you have received an undamaged appliance. If you do find transport damage, please contact the seller from which you purchased the appliance, or the regional warehouse from which it was supplied. The telephone number can be found on the invoice or on the delivery note.



**INFORMATION!**

Information, advice, tip, or recommendation



**WARNING!**

Warning – general danger

# Contents

<b>Safety precautions</b> .....	<b>4</b>
<b>Appliance description</b> .....	<b>7</b>
Technical data .....	7
Before first use .....	8
Hob .....	9
<b>Operating the cooking hob</b> .....	<b>12</b>
Control unit .....	12
Switching on the hob .....	13
Switching on the cooking zones .....	13
Changing the cooking zone settings .....	13
Automatic rapid heating .....	13
Bridged cooking zone .....	14
Pan position recognition with automatic bridging of cooking zones .....	15
Changing the cooking power level by moving the pan .....	16
Rapid cooking - Power Boost .....	16
Overheat protection .....	18
Automatic switch off .....	18
Memory function .....	18
Pausing the cooking process – Stop&Go(pause) .....	18
Child lock / lock .....	18
Time functions .....	19
AUTOMATIC COOKING PROGRAMS – IQ FUNCTION .....	21
Switching off the cooking zone .....	24
Residual heat indicator .....	24
Maximum cooking time .....	24
Switching off the entire cooking hob .....	24
<b>User settings</b> .....	<b>25</b>
<b>Cleaning and maintenance</b> .....	<b>27</b>
<b>Troubleshooting table</b> .....	<b>28</b>
Noises during induction cooking .....	29
<b>SAFETY FUNCTIONS AND ERROR DISPLAY</b> .....	<b>30</b>
<b>Installing a built-in hob</b> .....	<b>31</b>
Installation procedure .....	31
Air vents in the lower kitchen cabinet .....	32
Flush-mount installation into the worktop .....	33
Fitting the foam gasket .....	38
<b>Connecting the cooking hob to the power mains</b> .....	<b>39</b>
Connection diagram .....	39
<b>Disposal</b> .....	<b>41</b>

## Safety precautions



### **IMPORTANT SAFETY PRECAUTIONS – CAREFULLY READ THE INSTRUCTIONS AND SAVE THEM FOR FUTURE REFERENCE.**

This appliance can be used by children aged from 8 years and above and persons with reduced physical, sensory or mental capabilities or lack of experience and knowledge if they have been given supervision or instruction concerning use of the appliance in a safe way and understand the hazards involved. Children shall not play with the appliance. Cleaning and user maintenance shall not be made by children without supervision.

**WARNING:** The appliance and its accessible parts become hot during use. Care should be taken to avoid touching heating elements.

Children less than 8 years of age shall be kept away unless continuously supervised.

Do not use steam cleaners or high-pressure cleaners to clean the appliance, as this may result in an electric shock.

The appliance is not intended to be controlled by external timers or separate remote control system.

Means for disconnection must be incorporated in the fixed wiring in accordance with the wiring rules.

If the supply cord is damaged, it must be replaced by the manufacturer, its service agent or similarly qualified persons in order to avoid a hazard (only for appliances supplied with connection cord).

**WARNING:** If the surface is cracked, switch off the appliance to avoid the possibility of electric shock. Switch off all cooking zones using their respective controls and remove the fuse or trip the main circuit breaker so that the appliance is fully isolated from the power mains.

**WARNING:** Unattended cooking on a hob with fat or oil can be dangerous and may result in fire. NEVER try to extinguish a fire with water, but switch off the appliance and then cover flame e.g. with a lid or a fire proof blanket.

**WARNING:** Danger of fire: do not store items on the cooking surfaces.

**CAUTION:** The cooking process has to be supervised. A short term cooking process has to be supervised continuously.

**CAUTION:** This appliance is for cooking purposes only. It must not be used for other purposes, for example room heating.

**WARNING:** Use only hob guards designed by the manufacturer of the cooking appliance or indicated by the manufacturer of the appliance in the instructions for use as suitable or hob guards incorporated in the appliance. The use of inappropriate guards can cause accidents.

After use, switch off the hob element by its control and do not rely on the pan detector.

Appliance must be connected to fixed wiring which has incorporated means of disconnection. Fixed wiring must be made in accordance with the wiring rules.

# Appliance description

(depending on the model)

## INFORMATION!

Since the appliances for which these instructions were drawn up may have different equipment, some functions or equipment may be described in the manual that may not be present in your appliance.

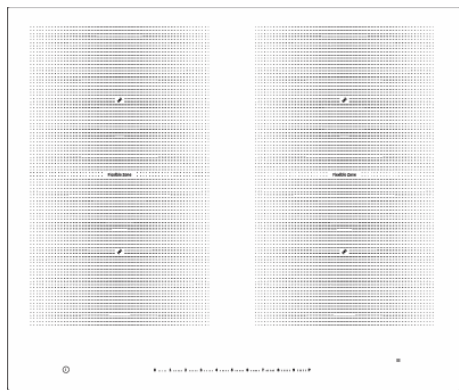

1. Induction cooking zone rear left
2. Induction cooking zone rear right
3. Induction cooking zone front left
4. Induction cooking zone front right
5. Cooking hob control module

## Technical data

(depending on the model)

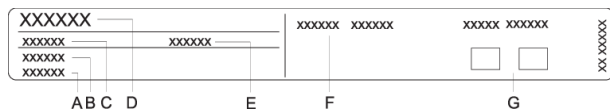

- A. Serial number
- B. Code
- C. Type
- D. Trademark
- E. Model
- F. Technical data
- G. Compliance indications / symbols

**The rating plate with basic information on the appliance is located on the bottom side of the cooking hob. Information on appliance type and model can be found on the warranty sheet.**

## Before first use

If your hob has a **glass ceramic** surface, clean it with a damp cloth and some washing-up liquid. Do not use aggressive cleaners, such as abrasive cleaners that could cause scratches, abrasive dishwashing sponges, or stain removers.

During initial use, characteristic "new appliance smell" may appear; it will gradually disappear.



# Hob

## Glass ceramic cooking surface

- The hob is resistant to temperature changes.
- Do not use the glass ceramic hob if it is cracked or broken. If a sharp object falls on the hob, the hob may break. The consequences of such occurrence may be visible immediately or only after a while.
- If any visible crack appears in the hob, immediately cut off the power supply to the appliance.
- Make sure the cooking zone and the cookware bottom is clean and dry. This will allow better conduction of heat and prevent any damage to the heating surface.
- Do not place empty cookware on the cooking zone. The cooking zone may be damaged if you place an empty pan onto it. Before placing a pan onto the cooking zone, wipe the pan bottom dry to allow conduction of heat.

## Cooking power levels

Cooking zone heating power can be set to 18 different levels (depending on the model). The table lists some examples of use for each level.

Cooking power level	Purpose
0	switched off , using the residual heat
1 - 2	keeping the food warm, slow cooking of smaller amounts (lowest setting)
3	slow cooking (follow-up cooking after the initial power boost)
4 - 5	slow cooking (follow-up cooking) of large amounts, pan-roasting of larger chunks
6	searing and browning
7 - 8	searing
9	cooking of large amounts, searing
P	Power Boost setting for start of the cooking process; also suitable for very large amounts of food

## Energy saving tips

- When purchasing cookware, note that the diameter indicated on the pan usually pertains to the upper edge or the lid, which is normally larger than the diameter of the pan bottom.
- If a dish takes a long time to cook, use a pressure cooker. Make sure there is always sufficient liquid in the pressure cooker. If an empty cooker is placed on the cooking hob, it may overheat which in turn may lead to damage to both the pot and the cooking zone.
- Whenever possible, close the pot or pan with a suitably sized lid. Use cookware that fits the amount of food you are cooking. Cooking in a large partly full pot will consume much more energy.

## Induction cooking zone operating principle

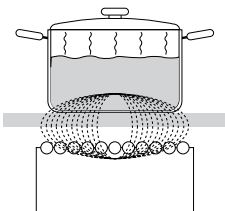

- The cooking hob is fitted with highly efficient induction cooking zones. The heat is generated directly in the bottom of the pan where it is needed the most. This avoids any losses through the glass ceramic surface. Power consumption is considerably lower than in conventional cooking zones with radiation heaters.
- The glass ceramic cooking zone is not heated directly, but only indirectly with the heat radiated back by the pan. After the cooking zone is switched off, this residual heat is indicated by "H".

- In induction cooking zones, heating is made possible by the induction coil installed under the glass ceramic surface. The coil induces a magnetic field which generates eddy currents in the bottom of a ferromagnetic pan, which in turn heats the pan.

### **WARNING!**

If sugar or food with high sugar content is spilled over a hot class ceramic hob, immediately wipe the hob or remove the sugar with a scraper, even if the cooking zone is still hot. This will prevent any damage to the class ceramic surface.

Do not use detergents and other cleaners to clean a hot glass ceramic hob as this could damage the surface.

### **Pan recognition**

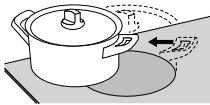
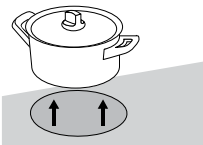
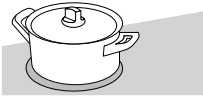

- Even if there is no pot or pan on the cooking zone or if the pan used has a diameter that is smaller than the diameter of the cooking zone, there will be no losses of energy.
- If the pan is much smaller than the cooking zone, there is a possibility that it will not be recognized by the cooking zone. When the cooking zone is activated, the sign  and the selected power level will flash alternately on the cooking power display.
- If a smaller pan or pot is placed on the cooking zone and it is recognized, the hob will only use as much power as necessary given the pan size.

### **Induction cookware**

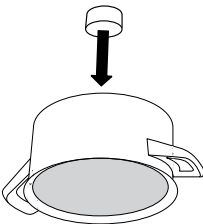

- The induction will work correctly if you use suitable cookware.
  - Make sure the pot or pan is in the middle of the cooking zone
  - Suitable cookware: cookware made of steel, enamel-coated steel pans, or cast iron pans.
  - Unsuitable cookware: alloy steel cookware with copper or aluminium bottom, and glass cookware.
  - The magnet test: Use a small magnet to check whether the pan or pot bottom is ferromagnetic. If the magnet sticks to the bottom of the pan, then it is suitable for an induction cooker.
- When using a pressure cooker, keep an eye on it until the right pressure is reached. First, set the cooking zone to maximum power; then, following the pressure cooker manufacturer's instructions, decrease the cooking power when appropriate.

- Make sure there is enough liquid in the pressure cooker, or any other pot or pan. Due to overheating, using an empty pot on the cooking zone may result in damage to both the pot and the cooking zone.
- Some cookware does not have a fully ferromagnetic bottom. In such case, only the magnetic part will heat up, while the rest of the bottom will remain cool.
- When using special cookware, observe the manufacturer's instructions.
- For best cooking results, the ferromagnetic area on the cookware bottom should match the size of the cooking zone. If the cooking zone does not recognize the pan, try placing it on a different cooking zone with a smaller diameter.

<b>Cooking zone</b>	<b>Minimum pan bottom diameter</b>
Ø 160 mm	Ø 90 mm
Ø 180 mm	Ø 90 mm
Ø 210 mm	Ø 110 mm
190 x 210 mm	Ø 110 mm
Bridge (octa)	Ø 230 mm

Pan bottom has to be flat.

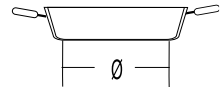
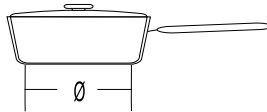
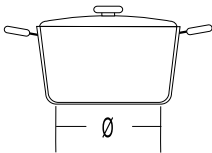

# Operating the cooking hob

## Control unit

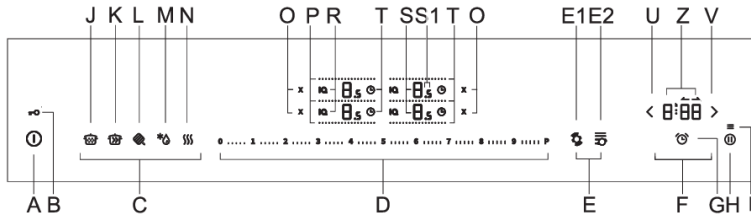

**A** Hob on/off key

**B** Control unit lock /child lock

**C** IQ functions

**D** Slider

**E** Smart functions

**E1** Pan position recognition with automatic pan recognition and automatic bridging of cooking zones

**E2** Changing the cooking power level by moving the pan

**F** Timer functions

**G** Program timer settings key

**H** Stop/Go, Pause, Memory function

**I** Settings

**J** Slow cooking

**K** Cooking with a large amount of water

**L** Frying/searing

**M** Defrosting frozen food

**N** Keeping the food warm

**O** Cooking zone quick switch-off key

**P** Bridged zone display

**R** IQ function activation and display key

**S** Power level/residual heat display

**S1** Half-step

**T** Program timer activation key

**U** Timer settings decrease key

**V** Timer settings increase key

**Z** Timer display

Display units also work as keys for adjusting the settings.

## Switching on the hob

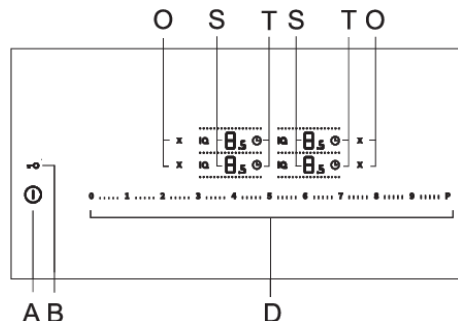

Place the cookware onto the cooking hob.  
Touch the on/off key (A) to switch on the hob.  
"0" will appear on all cooking zone displays (S).  
A short beep will be emitted.



### INFORMATION!

If no cooking zone is switched on in 10 seconds, the cooking hob will power off.

## Switching on the cooking zones

- Touch the display unit for the desired cooking zone. The selected display unit will flash. Keys on the slider (D) light up, but they are dimmed (only with some models).
- In the next 5 seconds, touch the selected area/position on the slider (D). The display will stop flashing and the actually set power level will be displayed. Timer (T) functions and the quick switch-off key (O) will appear next to the power level display for the selected cooking zone (S). Both display units are lit, but dimmed.
- The cooking zone remains activated.
- If the hob does not recognize any pan on the selected cooking zone, the symbol ☒ appears. If you do not place a pan on the selected cooking zone within 2 minutes, the cooking zone will automatically switch off.

## Changing the cooking zone settings

Select the desired cooking zone by pressing on the power level display unit (S). Power level can be set by sliding or by directly touching an area or position on the slider (D).

### Two vertically adjacent cooking zones (one behind the other)

- The power Power Boost cannot be activated simultaneously for both cooking zone on the same side of the hob (i.e. both left-hand-side zones or both right-hand-side zones), as this would result in current overload.
- If the power boost is already set for one of the cooking zones, then the maximum available power level for the other cooking zone is 9.

## Automatic rapid heating

All cooking zones are fitted with a special mechanism that sets the cooking power to maximum at the start of the cooking process, regardless of the actual power setting. After a while, the cooking zone power switches back to the initially set level. Automatic rapid heating can be activated on every cooking zone for any cooking power level except for level "9" and "P".

**The auto rapid heating function is suitable for dishes** that have to be heated up and then cooked for a longer period of time without the need for constant supervision.

The auto rapid heating function is suitable for dishes that have to be heated up and then cooked for a longer period of time without the need for constant supervision.

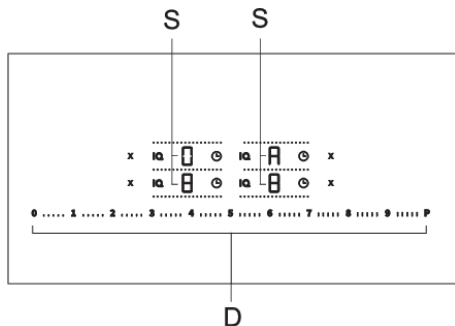

The hob is switched on and a suitable pan is placed on one of the cooking zones. Select the desired cooking zone that should be switched off ("0" should appear on the display unit). Press on the relevant position on the slider to set the power and keep your finger pressed on the slider for around 3 seconds. "A" and selected power level will alternate on the power level display. When the automatic rapid heating time expires, the cooking zone automatically switches to the selected level which will then be continuously displayed.

### Automatic rapid heating table

Power level	1	1,5	2	2,5	3	3,5	4	4,5	5	5,5	6	6,5	7	7,5	8	8,5
Automatic rapid heating time (sec)	40	60	70	100	120	150	180	220	260	300	430	400	120	150	195	200

### Switching off the automatic rapid heating

If cooking power is decreased while the automatic rapid heating is activated, the automatic rapid heating will be switched off for this cooking zone.

The auto function can be deactivated by selecting the relevant cooking zone and decreasing the power level to "0". Then, set the new power level.

### Bridged cooking zone

(depending on the model)

- Some models allow combining two cooking zones into a single large connected cooking zone. Thus, a large oval pan or a griddle can be placed on the combined cooking field. The pan has to be large enough to cover the centres of the upper and lower cooking zone.
- Maximum pan size: 40 x 25 cm. For even heat distribution, we recommend using a heavy-bottom baking dish or pan. During cooking, the dish or pan will heat up. Be careful to prevent burns.
- When placing the baking dish on the hob, make sure it does not cover the control module.



#### INFORMATION!

The pan should always cover the centre of the cooking zone!

### Activating the bridged cooking zone

- Switch on the cooking hob by pressing the on/off sensor (A).
- Cooking zones that you wish to bridge have to be switched off.
- Touch the selected power level display to select the first cooking zone. Immediately afterwards, touch the display unit of the adjacent cooking zone that you wish to bridge with the first one.

- The lit lines indicate the bridged cooking zone for which only the lower power level display unit will be lit, indicating a flashing "0"; the lit line between the cooking zones will disappear.
- Use the slider to set the desired power level for the bridged zone.
- To change the cooking power later on, first press on the display unit for the lower cooking zone.



#### INFORMATION!

The bridged cooking zone does not allow operation with a power boost; only power levels up to 9 are available.

### Deactivating the bridged cooking zone

Set the power level for the bridged cooking zone to "0" or switch off the cooking zone using the (O) key. "0" will appear on the display unit. After a few seconds, all cooking zones will again operate independently.



#### INFORMATION!

If two cooking zones are bridged, but there is no pan on one of the bridged zones, the bridged zone will be separated after 2 minutes. The inactive zone will be switched off.

## Pan position recognition with automatic bridging of cooking zones

(only with some models)

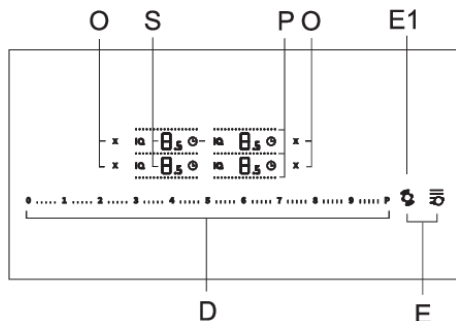

Pan position recognition is activated automatically 10 seconds after the appliance is switched on. If there is a pan on the hob, the pan recognition function will recognize its position and automatically bridge the cooking zones depending on the size of the pan. Two adjacent cooking zones can be merged into a single large cooking zone. Only the display unit for the lower cooking zone remains active and visible, displaying a flashing "0". The separation line (P) disappears.

Now, you can use the slider to set the power level. The pan recognition key (E1) is lit, but dimmed. Automatic bridging of the cooking zones is possible across vertically adjacent cooking zones. Automatic pan position recognition can be activated at any time for 10 seconds by pressing the pan recognition key (E1). Automatic pan recognition and automatic cooking zone bridging are only effective on the cooking zones that are not yet activated. The cooking zone bridge function can be switched off by setting the power level to "0" or by pressing the relevant deactivation key (O). The function can be used if the pan is already on the cooking hob or if the cooking hob is empty.

#### If there is no pan on the cooking hob:

- Switch on the hob. All cooking zones are set to "0"
- Place the pan on any cooking zone. »0« starts to flash on the cooking zone with the pan. Now, you can use the slider to set the power level. The function automatically bridges the cooking zones depending on the pan size.
- You may continue with the next pan, using the same procedure.

- This function allows you to set the power level faster. Simple place the pan on any cooking zone and the zone will automatically recognize the pan.

#### If the pan is already on the cooking hob:

- Switch on the cooking hob.
- "0" will flash on the display unit of the cooking zone with the pan on it. Now, you can use the slider to set the power level.
- If there are several pans on the cooking zone, the appliance automatically continues with the selection for the next zone. "0" will flash on the next cooking zone display unit.

If you press the cooking zone selection key, the automatic pan recognition is deactivated and the appliance switches to manual settings mode.



#### WARNING!

During the first 10 seconds, automatic recognition can also be deactivated in user settings using the "Aut" parameter.

## Changing the cooking power level by moving the pan

(only with some models)

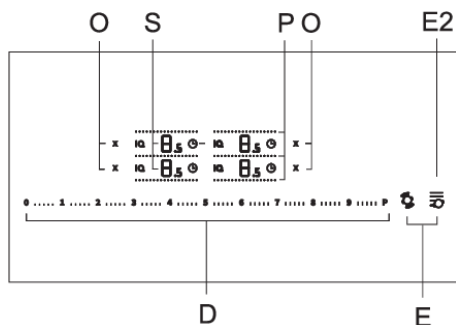

Changing the cooking power level by moving the pan is only possible in some models on the left-hand side of the cooking zone. Touch the power level display for the selected lefthand side cooking zone, which will start to flash. The key for the function of adjusting the power by moving the pan (pan motion control) (E2) will light up. Press this key to activate the function. Both cooking zones on the left-hand side are activated as a single large cooking zones with a number of preset power levels: lower zone at level 9, upper zone at level 3.

The pan motion control key is fully lit. Power level of these two cooking zones can be later adjusted to new values using the same procedure as for conventional changing of the power level. The pan motion control function can be deactivated by pressing the quick switch-off key (O) for the cooking zone or by setting the power level to 0.

## Rapid cooking - Power Boost

(depending on the model)

The function allows temporary cooking at maximum power for up to 5 minutes. Then, the operating power is automatically reduced to level 9. The function can be reactivated if the system is not overheated.

#### Activating the Power Boost

- Choose the cooking zone and touch the slider (D) at the »P« symbol.
- »P« will appear on the power level display.
- The Power Boost function is not activated.



### **Deactivating the Power Boost**

- Switch off the selected cooking zone
- Decrease the power level.

## Overheat protection

- The hob is fitted with a cooling fan which cools the electronic components during cooking. The fan may operate for a while even after the end of the cooking process.
- Induction cooking hob is also fitted with an overheating protector which protects the electronic components from damage. The protector operates at several levels. When the cooking zone temperature gets very high, the cooking power is automatically reduced. If this does not suffice, the cooking zone power continues to decrease, or the safety mechanisms switches off the cooking zone completely. In such case, the display unit will read ""F2"". When the cooking hob is cooled down, its total power will be available again.

## Automatic switch off

If the keys are activated for too long during cooking (e.g. due to spilt liquid or an object placed over the sensor keys), all cooking zones will be switched off after 10 seconds. The symbol  will flash on the display.

The object should be removed, or the spilt liquid should be cleaned, from the sensor keys within 2 minutes; otherwise, the cooking hob will switch off automatically. The most recent settings can be restored with the memory function using the Stop&Go (H) key.

## Memory function

This function allows you to retrieve all cooking zone settings if the cooking hob was accidentally switched off. However, this can only be done within five seconds after the hob has been switched off.

- Use the on/off key (A) to switch the cooking hob back on within 5 seconds after it has been switched off. The key (H) will flash on the display unit for 5 seconds. Within that time, touch this key and all settings that were active just before the hob was switched off will be restored.

## Pausing the cooking process – Stop&Go(pause)

The Stop&Go function can be used to pause the operation of the entire cooking hob for up to 10 minutes. All cooking zones will temporarily switch off automatically. This is convenient when, for example, the contents of one of the pans has boiled over and you wish to clean the cooking hob.

### Activating the Stop&Go function

At least one or more cooking zones are active. Touch the Stop&Go key. A short beep will be emitted. All settings on display units start to flash; the pause key will be lit and it will also flash. All program timer or minute minder settings are paused. All keys are inactive, except for the pause (stop/go) key and the on/off key. If you do not press any key within 10 minutes, all active cooking zones will switch off automatically.

### Ending the Stop&Go function

Press the pause key sooner than after 10 minutes. The cooking hob continues to operate with the same settings as before the pause.

## Child lock / lock

The cooking hob can be locked against unintended activation.



### INFORMATION!

The cooking hob has to be switched off or in the standby mode.

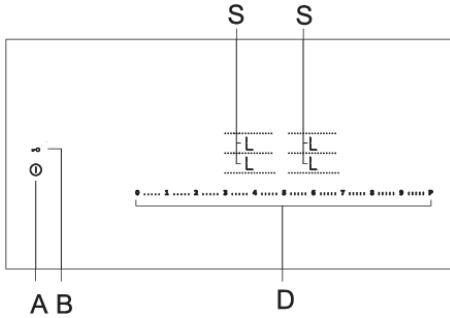

### Activating the lock

The cooking hob has to be switched off or in the standby mode. Switch on the cooking hob by pressing the on key (A). Touch the child lock key (B) and hold it for 3 seconds. "L" will appear for 5 seconds on all cooking zone displays. The cooking hob is now locked. After 5 seconds, the cooking hob will automatically switch off to standby mode.

### Deactivating the lock

Cooking hobs controls can be unlocked in the same way (in the reverse order). Switch on the cooking hob by pressing the on key. "L" will appear on all cooking zones. Touch the child lock key (B) and hold it for 3 seconds. "0" will appear on all cooking zone display units instead of "L". The cooking hob is now ready for use.

Note: If the child lock function (B) is activated in the user settings mode (see chapter "User Settings Mode", then the hob will be automatically locked every time it is switched off.

### INFORMATION!

Activate the lock function before cleaning to prevent the hob from being inadvertently switched on.

## Time functions

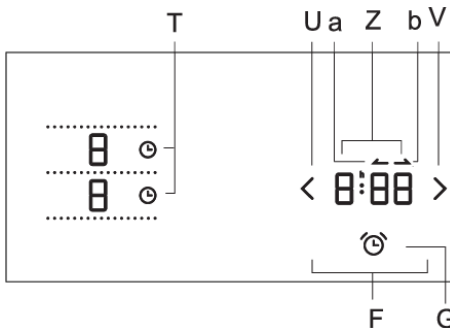

This function allows two operating modes:

- Setting the minute minder (countdown timer) function applies to the entire cooking hob. The function simply beeps when the set time expires.
- Program timer setting that applies to the selected cooking zone. A separate timer can be set for each cooking zone. When the set time expires, the cooking zone is automatically switched off.

### 1 Minute minder (or countdown timer)

The minute minder operates independently and it is not related to the operation of any cooking zone. When the countdown timer is set, it will continue to count down the time even if you switch off the cooking hob. The minute minder can only be switched off when the cooking hob is on.

#### Activating the minute minder (countdown timer)

The cooking hob is switched on.

- Touch the minute minder selector key. The key will start to flash.

- "0:00" will appear on the timer display unit.
- Use the (U) and (V) keys to set the time. If no time is set within ten seconds, the minute minder will be switched off automatically.
- When the minute minder is active, the minute minder selector key is fully lit.
- The minute minder remains active even if you switch off the hob.

### Deactivating the count-down timer

- If the cooking hob is switched off, first touch the on/off key to switch on the cooking hob.
- Simultaneously touch the (U) and (V) timer/minute minder settings keys. Alternatively:
- Touch the (U) timer/minute minder settings key and hold it until "0:00" appears on the display unit.

## 2 Program timer

The program timer makes the cooking process easier by allowing you to see and set the cooking time for the selected cooking zone. When the time set on the timer expires, the cooking zone will automatically switch off and emit an acoustic signal. Switch of the acoustic signal by touching any key; alternatively, it will switch off automatically after a while. The switch-off program timer can be set independently for all cooking zones. The program timer may only be set for an active cooking zone.

### Cooking time display – stopwatch

The cooking hob is switched on.

- Press the timer selector key for the desired active cooking zone (T). The key starts to flash.
- The time elapsed since the relevant cooking zone was switched on and a count-up symbol (b) are displayed on the timer display unit.

### Setting the program timer

The cooking hob is switched on.

- Press the timer selector key for the desired active cooking zone (T). The key starts to flash.
- The time elapsed since the cooking zone was switched on "1:15" and a count-up symbol (a) are displayed.
- Press the timer display (Z) to set the time to "0:00" and the countdown symbol. Use the (U) and (V) keys to set the cooking time. The program timer key for the relevant cooking zone will be fully lit.
- If the time is not set within five seconds using the (U) and (V) keys, the program timer will be automatically switched off.
- Repeat the same steps to set the program timer or stopwatch for another active cooking zone.

### INFORMATION!

If the program timer is simultaneously activated for multiple cooking zones, then the most recently selected time will be displayed on the display unit. When the remaining time for one of the cooking zone is shorter than one minute, then the time for that cooking zone will be displayed. The last minute before the expiry of the set time, the time will be displayed in seconds.

### Switching off the program timer

- Touch the program timer selector key to select the program timer or the countdown timer that you wish to deactivate.
- Simultaneously touch the (U) and (V) timer/minute minder settings keys. Or:
- Touch the (U) timer/minute minder settings key and hold it until 0:00 appears on the display unit.

### Switching off the program timer/minute minder alarm

When the set time or cooking time expires, an alarm is sounded. The program timer/minute minder selector key for the relevant cooking zone flashes, and "00" will flash on the timer display unit. Touch any key to switch off the alarm.

To set the cooking time faster, touch and hold the (U) or (V) key. If you press the (U) key immediately after activating the program timer/minute minder, you can set the desired operating/cooking time, starting with 1:00 (1 hour). The program timer shall have preference over the safety switch-off when the longest allowed cooking time is reached.

Alarm duration can be changed in user settings with the "Sou" parameter. There is an additional parameter "Uol" specifying the alarm volume. In the user settings, you can deactivate the automatic stopwatch (count-up) timer for the activated cooking zone with the parameter "CLo". In this case, after you select the timer, "0:00" will be displayed on the display unit and the stopwatch (count-up timer) will be activated.

## AUTOMATIC COOKING PROGRAMS – IQ FUNCTION

The IQcook system automatically controls the cooking progress; however, it does not automatically switch off the functions after the end of cooking. This has to be done manually or by means of a TIMER - a countdown timer or a minute minder.



### Use of functions

The IQcook system can be used on any cooking zone by touching the IQ keys and selecting the cooking program.

**Use the lid for all functions except for frying/searing. Optimum program operation is only guaranteed in this case. Use the same pot or pan until the end of the cooking process.**

Before switching on the hob, the cooking zone and the bottom of the pot or pan must be clean and dry.

Preparation procedure

Fill the pot or pan with water and food and place it on the cooking zone.

**When cooking with water, make sure the water level is no less than 50 mm bellow the upper edge of the pot or pan.**

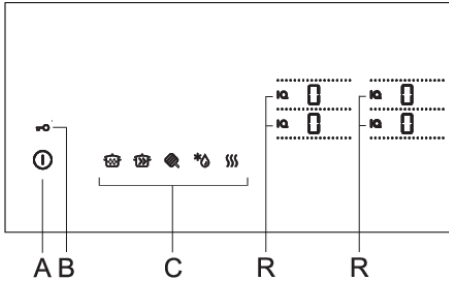

- Cover the pan with a lid. Touch the cooking hob on/off key (A). A short beep will be emitted.
- Activate the IQcook system by touching the IQ symbol for the selected cooking zone. All possible cooking programs (C) will light up and the IQ symbol will be fully lit. Select the desired cooking program. Only the frying/searing program (L) allows additional settings A C displayed in the power control area.

- The automatic cooking program is now activated and cooking starts within 5 seconds after pressing the selected IQ program key. The IQ symbol will be fully lit and " \_ " will be displayed on the display unit to indicate the start of the cooking process.
- You may set any program timer function (F).



**SLOW COOKING** This function is used for dishes that take longer to cook, with slow heating and maintaining a gentle boil.

Dishes: SOUPS, GOULASH, STEWS, SAUCES, RICE etc.

The slow cooking program allows a combination of multiple programs, for example: making Bolognese sauce. First select the frying/searing program to heat up the oil. When the cooking hob beeps, add the onion and sauté it, then add the meat, water, canned tomatoes, herbs and spices ... Then, use this or another cooking zone to select the slow cooking program and cook the sauce at a low temperature for the rest of the process. The slow cooking program can be activated after the contents were brought to the boil by manual setting. For example: boil the soup manually on level 9 or P; then, switch to the slow cooking program to continue simmering.

#### **IQ system safety function – smartsense**

Smartsense makes sure the food in the pan does not burn. The symbol "b" will appear on the display and the hob will beep. The system will cut the power supply. The symbols remain lit until they are switched off by the user.

Note: Rice – wash in water before cooking. Note that two or three parts water should be added for each part rice.

#### **The following symbols will appear on the display during operation:**

Optimum temperature has not been reached yet: " \_ ".

Optimum temperature has been reached: "= ".



#### **COOKING WITH A LARGE AMOUNT OF WATER**

The function allows bringing the water rapidly to the boil and maintaining the boiling temperature. The function is suitable for cooking water-based dishes and dishes cooked in water. Dishes: VEGETABLES, POTATOES, PASTA ...

Note: Before cooking, wash the vegetables, especially potatoes, thoroughly in water. This will prevent foaming during the cooking process. When the water is brought to the boil (with the lid in place), the symbol (=) will be lit and a beep will be sounded.

Some types of food may foam during cooking. Lift the lid and stir the contents. Use a lid with a release valve! When cooking with a large amount of water, it is possible that the liquid is not visibly boiling yet. Leave the lid on the pan or pot until the system heats the water to a gentle boil. Intensity of maintaining the boil may also depend on the type of pan and lid.

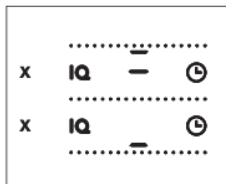

**The following symbols will appear on the display during operation:**

Optimum temperature has not been reached yet: " \_ ".

Optimum temperature has been reached: "= ".



**FRYING/SEARING**

Suitable for cooking meat at various power levels. The meat will cook evenly and remain juicy. The frying/searing function is suitable for pans that only require a small amount of oil, up to a depth of 10 mm. When the appropriate oil temperature has been reached, the symbol " \_ " appears on the display unit. The cooking hob will beep and the food can now be added to the pan. Suitable for COOKING ALL TYPES OF MEAT, FISH, CRÊPES OR PANCAKES, EGGS, VEGETABLES etc.

Note: Crêpes and pancakes – Distribute the oil evenly across the surface of the pan and place the pan on the cooking zone. Switch on the IQ system. When the symbol "= " appears on the display unit, add the crêpe or pancake batter. With every subsequent crêpe or pancake, first place the empty pan with oil onto the cooking zone for approx. 30 seconds and then add the following batch of batter.

The desired power level can be set at the start, or it can be changed during operation.

Power levels:

- Level 1 = very low
- Level 2 = low (preset)
- Level 3 = medium
- Level 4 = high

To choose the power level, first press the IQ program frying/searing. Then, all possible levels from 1 to 4 appear on the display unit for a few seconds, after which the display unit returns to level 2 (preset value). While the power level is displayed, you can press on the relevant part of the slider to adjust the cooking power level. You can also adjust the power level later on, during cooking, by first pressing the IQ key, and then setting the desired power level.



**NOTE!**

The present temperature is "low".

**The following symbols will appear on the display during operation:**

Optimum temperature has not been reached yet: " \_ ".

Optimum temperature has been reached: "= ".



**DEFROSTING FROZEN FOOD**

This function is suitable for defrosting all types of frozen food. The function is also suitable for melting chocolate.

The function is also suitable for melting chocolate.



## KEEPING THE FOOD WARM

This function is suitable for keeping food of any type warm. It keeps the food temperature at around 70 °C. It is also suitable for making mulled wine.

Example: When cooking goulash with the slow cooking function, switch to this system after the cooking is done and the food will remain warm.

**The following symbols will appear on the display during operation:**

Optimum temperature has not been reached yet: "\_ \_".

Optimum temperature has been reached: "= ".

## Switching off the cooking zone





The cooking zone can be switched off using the relevant key (O) that is lit next to the active cooking zone. If power level for all cooking zones is set to "0", then the entire hob will be switched off after 10 seconds.

## Residual heat indicator

The glass ceramic hob is also fitted with a residual heat display, "H". The glass ceramic cooking zone is not heated directly, but only indirectly by the heat radiated back by the pan. As long as the symbol "H" is lit up after the hob has been switched off, there is residual heat in the cooking zone, which can be used to keep the food warm or for defrosting. When the "H" sign disappears, the cooking zone may still be hot. Be careful as there is danger of burns!

## Maximum cooking time

For safety, the cooking time for each cooking zone is restricted to a maximum duration. Maximum cooking time depends on the most recently set power level. If the power level is not changed, the cooking zone will be switched off automatically after the maximum cooking duration is reached.

Level	1	2	3	4	5	6	7	8	9	P*					
Maximum operating time (hours)	8	8 2,5	6	6 4,5	4	4 6,5	2 7,5	1,5 8,5	1,5	1,5	6	6	6	8	2

\* After 5 minutes, the power level automatically decreases to 9; after 1.5 hours, the cooking zone is switched off.

## Switching off the entire cooking hob

The cooking hob may be switched off at any time by touching the on/off key (A).



# User settings

## Setting the acoustic signal, automatic features, and lock parameters

You can adjust the acoustic signal volume (loudness) and acoustic alarm duration, activate automatic lock, deactivate the automatic timer, and deactivate automatic pan recognition.

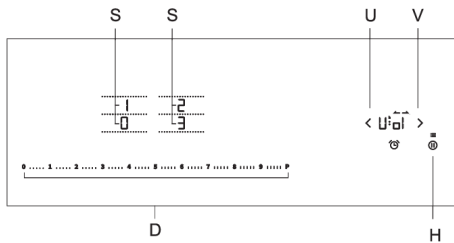

**Uol:** Acoustic signal and alarm volume (loudness)

**Sou:** Alarm duration

**Loc:** Automatic lock

**Aut:** Automatic pan recognition

**CLo:** Automatic timer activation

**P xx:** Total maximum power (setting is possible within 2 minutes after connecting the appliance to the power mains)

To activate the parameter settings menu, press the pause key (H) when the appliance is switched off, and hold it for 3 seconds. The first parameter "Uol" will appear on the timer display, indicating the volume (loudness) of acoustic signals. Press the timer setting keys (U) and (V) to choose the type of setting.

Available parameter values appear on the cooking zone power display units. To change the value, press the selected parameter which will light up more intensively/brightly. All parameters can be confirmed and stored by pressing the pause key (H) and holding it for 2 seconds. Then, a short beep will be sounded. If you do not wish to store the new parameter settings, close the user settings mode by pressing the on/off key.

### Acoustic signal and alarm volume (loudness) »Uol«

The following values can be set:

**0** on the display = off (does not apply to alarm and error acoustic signal)

**1** on the display = minimum volume

**2** on the display = medium volume

**3** on the display = maximum volume (default)

A short acoustic signal will be sounded upon every change, with the newly set volume.

### Acoustic alarm duration »Sou«

The following values can be set:

**0** on the display = 5 seconds

**0.5** on the display = 1/2 minute

**1** on the display = 1 minute

**2** on the display = 2 minutes (default)

### **Child safety lock »Loc«**

If the automatic lock function is activated in the user settings mode, the cooking hob will be automatically locked every time it is switched off.

**0** on the display = off (default)

**1** on the display = on

### **Pan position recognition with automatic cooking zone bridging »Aut«**

If the function of pan position recognition with automatic cooking zone bridging is deactivated in the user settings mode, then the appliance will always be operated manually (there will be no 10-second automatic pan recognition every time the appliance is switched on).

**0** on the display = off

**1** on the display = on (default)

### **Automatic timer activation "CLo"**

If the automatic timer activation is deactivated in the user settings mode, the appliance will only display "0:00" when you press the timer symbol, rather than the time elapsed since the activation of the cooking zone.

**0** on the display = off

**1** on the display = on (default)

### **Total maximum power "Pxx" (xx indicates the power)**

To activate the setting, press and hold the pause key (H) for 3 seconds after connecting the appliance to the power mains. P74 will appear on the timer display, indicating a total power of 7.4 kW. Press the timer setting keys (U) and (V) to adjust the power limit. This setting can only be made or adjusted within 2 minutes after the appliance is connected to the power mains. If you wish to change this setting at a later time, the appliance must be disconnected from the power mains for a few seconds.

### **Maximum appliance power limit**

If the electric installation in your home has different current limits, maximum power consumption of the cooking hob can be reduced:

**P23** on the display unit = 2.3 kW = 10 A

**P28** on the display unit = 2.8 kW = 12 A

**P30** on the display unit = 3.0 kW = 13 A

**P37** on the display unit = 3.7 kW = 16 A

**P74** on the display unit = 7.4 kW = 2 x 16 A (preset)

The changed setting can be confirmed and stored by pressing the pause key (H) and holding it for 2 seconds. Then, a short beep will be sounded. If you do not wish to store the new parameter settings, press the on/off key.

### **INFORMATION!**

If the power level is limited, the settings and the resulting cooking power can be limited as well. The appliance is fitted with a power management system that makes sure the effect of power limiting is minimal.

# Cleaning and maintenance

After each use, wait for the glass ceramic surface to cool down and clean it. Otherwise, all remaining impurities will burn onto the hot surface the next time you use the hob.

For regular maintenance of the glass ceramic hob, use special care products that create a protective film on the surface to prevent the dirt from sticking onto it.

Before each use of the glass ceramic surface, wipe off the dust or any other impurities that could scratch the surface, from both the hob and the pan bottom.

## **INFORMATION!**

Steel wool, coarse cleaning sponges, and abrasive powders may scratch the surface. The surface may also be damaged by aggressive spray cleaners and unsuitable liquid cleaners.

Signage may be worn when using aggressive or abrasive cleaners or cookware with coarse or damaged bottom.

Use a damp soft cloth to remove minor impurities. Then, wipe the surface dry.

Remove water stains with a mild solution of vinegar. However, do not use this solution to wipe the frame (only with some models) as it may lose its sheen. Do not use aggressive spray cleaners or descaling agents.

Use special glass ceramic cleaners for stubborn dirt. Observe the manufacturer's instructions. Be sure to thoroughly remove any cleaner residues after the cleaning process as they may damage the glass ceramic surface when the cooking zones heat up.

Remove stubborn and burnt residues with a scraper. Be careful when handling the scraper to prevent injury.

## **INFORMATION!**

The scraper is not included in appliance equipment.

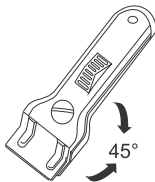

## **INFORMATION!**

Only use the scraper when dirt cannot be removed with a wet cloth or special cleaners for glass ceramic surfaces.

Hold the scraper at the correct angle (45° to 60°). Gently press the scraper against the glass and slide it over the signage to remove the dirt. Make sure the plastic handle of the scraper (in some models) does not come into contact with a hot cooking zone.

## **INFORMATION!**

**Do not press the scraper perpendicularly against the glass and do not scratch the hob surface with its tip or blade.**

Immediately remove any sugar or sugar-laden food from the glass ceramic hob using a scraper, even if the hob is still hot, as sugar may permanently damage the glass ceramic surface.

# Troubleshooting table

**During the warranty period, only a service center authorized by the manufacturer may carry out any repairs.**

Before making any repairs, make sure the appliance is disconnected from the power mains either by removing the fuse or by disconnecting the power plug from the wall outlet.

Any unauthorized repairs of the appliance may result in electric shock and short circuit hazard; therefore, do not perform them. Leave such work to an expert or a service technician.

In case of minor problems with appliance operation, check this manual to see if you can fix the problem yourself.

If the appliance is not operating properly or at all due to inappropriate operation or handling, a visit from a service technician shall not be free of charge, even during the warranty period.

Save the instructions for future reference and pass them on to any subsequent owners or users of the appliance.

Following is some advice on rectifying some common problems.

<b>Problem/error</b>	<b>Cause</b>
<b>The main fuse in your home trips often.</b>	Call a service technician.
<b>Continuous beep and display </b>	Water spilt over the sensor surface, or an object placed over the sensors. Wipe the sensor surface.
<b>F2 on the display</b>	Cooking zone has overheated. Wait for the cooking zone to cool down.
<b>F on the display</b>	This indicates that there has been an error during operation.

If the problems persist despite observing the above advice, call an authorized service technician. Repair or any warranty claim resulting from incorrect connection or use of the appliance shall not be covered by the warranty. In this case, the user will cover the cost of repair.



## **WARNING!**

Before the repair, disconnect the appliance from the power mains (by removing the fuse or by removing the plug from the wall outlet).

## Noises during induction cooking

Noises and sounds	Cause	Solution
<b>Inductiongenerated operating noise</b>	Induction technology is based on the properties of some metals under electromagnetic effect. It results in so-called eddy currents that force the molecules to oscillate. These oscillations (vibrations) are transformed into heat. Depending on the type of metal, this could result in quiet noises.	This is normal and it is not a result of any malfunction.
<b>Transformer-like buzz</b>	Occurs when cooking at a high power level. The reason for this is the amount of energy transferred from the cooking hob to the pot or pan.	This noise will disappear or weaken when you reduce the power level.
<b>Vibration and crackling of the cookware</b>	This noise appears in cookware (pots or pans) made of different materials.	It results from vibrations along the adjacent surfaces of different material layers. This noise depends on the cookware. It can vary depending on the amount and type of food being cooked.
<b>Fan noise</b>	Correct operation of induction electronic components requires temperature control. Therefore, the cooking hob is fitted with a fan that cools the electronics depending on the sensed temperature.	The fan may operate even after the cooking hob has been switched off, if the temperature remains too high.

# SAFETY FUNCTIONS AND ERROR DISPLAY

The cooking hob is fitted with overheating sensors. These sensors can automatically switch off any cooking zone or the entire hob temporarily.

## Error, possible cause, solution

Continuous beep and flashing on the display .

- Water spilt over sensor surface, or an object placed over the sensors. Wipe the sensor surface.

«F2» on the display

- Cooking zone has overheated. Wait for the cooking zone to cool down.

»F« on the display

- This indicates that there has been an error during operation.



### WARNING!

If an error occurs or if the error indicator "F" does not disappear, disconnect the cooking hob from the power mains for a few minutes (undo the fuse or switch off the main switch); then, reconnect the hob to the power mains and switch on the main switch key.

If the problems persist despite observing the advice above, call an authorised service technician. Repair or any warranty claim resulting from incorrect connection or use of the appliance shall not be covered by the warranty. In this case, the user will cover the cost of repair.



### WARNING!

Before the repair, disconnect the appliance from the power mains (by removing the fuse or by removing the plug from the wall outlet).

# Installing a built-in hob

## Installation procedure

- The worktop has to be completely level.
- Suitably protect the edges of the cut aperture.
- Connect the cooking hob to the mains power supply (see instructions for the connection of the cooking hob to mains power supply).
- Insert the hob into the cut aperture.

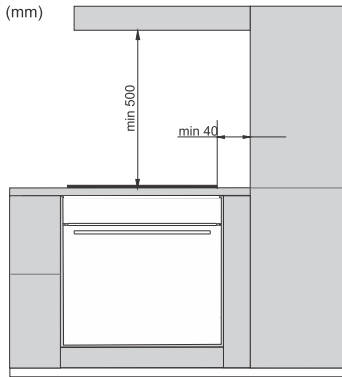

- Installation of the appliance into a kitchen worktop and its connection to the power mains may only be performed by an adequately qualified technician.
- Veneer or other finish of the piece of kitchen furniture into which the hob is to be built in should be treated with heat resistant glue (100°C); otherwise, the worktop finish may be discolored or deformed.
- Use of solid wood corner trims on worktops behind the cooking hob is only allowed if the clearance between the trim and the cooking hob is no smaller than indicated on the installation plans.
- Cooking hob is dimensioned to be built into the worktop over a piece of kitchen furniture, with a width of 600 mm or more.

- Hanging, or wall-mounted kitchen elements should be installed high enough not to interfere with the work process.
- The distance between the cooking hob and the kitchen hood should be no less than indicated in the instructions for kitchen hood installation. The minimum distance is 500 mm.
- The distance between the appliance edge and the adjacent tall kitchen furniture element should amount to no less than 40 mm.
- Use of solid wood corner trims on worktops behind the cooking hob is only allowed if the clearance between the trim and the cooking hob is no smaller than indicated on the installation plans.
- Minimum distance between the built-in cooking hob and the rear wall is indicated on the installation drawing.

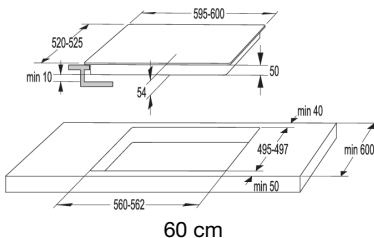

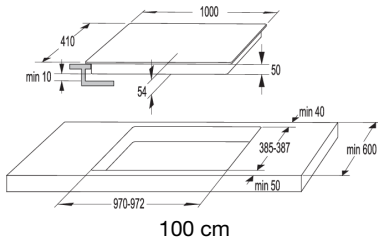
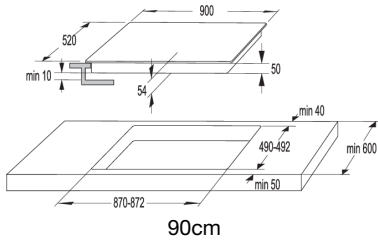
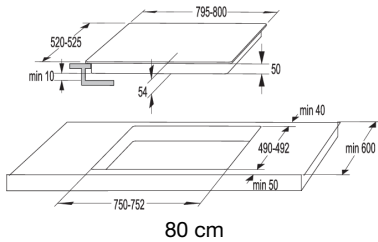

## Air vents in the lower kitchen cabinet



### INFORMATION!

Normal operation of the induction cooking hob electronic components requires sufficient air circulation.

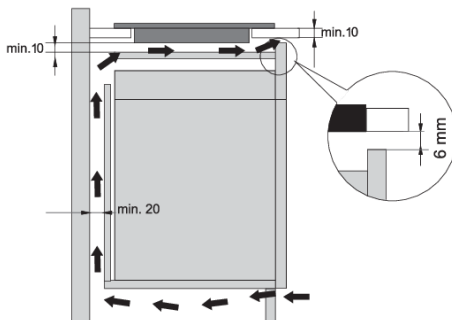

### Lower cabinet with a drawer

- There must be an opening with a height of no less than 140 mm along the entire width of the cabinet in the cabinet rear wall. In addition, there should be an opening of at least 6 mm in the front side, along the entire width of the cupboard.
- A horizontal partition panel should be installed underneath the cooking hob along its entire length. There should be at least 10 mm of clearance between the lower end of the appliance and the partition panel.



Adequate ventilation should be allowed from the rear side.

- The hob is fitted with a fan located in its lower part. If there is a drawer below the kitchen cabinet, do not use it to store small objects or paper as these could, if sucked into the fan, damage the fan and the cooling system. Moreover, do not use the drawer to store aluminium foil or flammable substances or liquids (such as sprays). Keep such substances away from the cooking hob. Danger of explosion!
- There should be at least 20 mm of clearance between the contents of the drawer and the fan inlet vents.

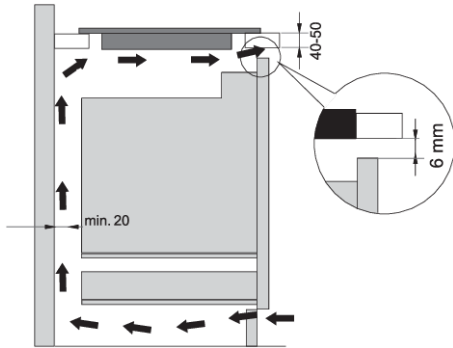

### Lower cabinet with an oven

- Installing an oven under the induction hob is possible for oven with a cooling fan.
- Before installing the oven, the kitchen cabinet rear wall has to be removed in the area of the opening for installation.
- In addition, there should be an opening of at least 6 mm on the front side, along the entire width of the cabinet.
- If other appliances are installed under the induction cooking hob we cannot guarantee their correct operation.

## Flush-mount installation into the worktop

Appliances without faceted edges or decorative frames, are suitable for flush mounting.



## Installing the appliance

The appliance may only be installed into a temperature- and water-resistant countertop, such as a countertop made of (natural) stone (marble, granite), or solid wood (the edges along the cut-out have to be sealed). When installing into a countertop made of ceramics, wood, or glass, a wooden sub-frame should be used. The frame is not supplied with the appliance. The appliance may only be installed into a countertop made of other materials after you have consulted the countertop manufacturer and obtained his express approval. Internal dimension of the basic unit should be at least equal to the internal cutout for the appliance. This will allow simple removal of the appliance from the countertop. Attach sealing tape along the perimeter of the bottom of the glass panel.

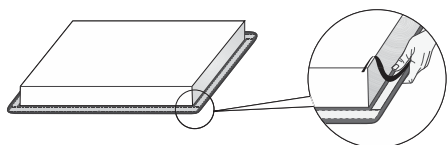

First, feed the power cord through the cutout. Place the appliance over the centre of the cutout. Connect the appliance to the power mains (see instructions for connecting the appliance). Before sealing the appliance, test its operation. Seal the slot between the appliance and the countertop using a silicone sealant. The silicone sealant used to seal the appliance has to be temperature-resistant (to at least 160 °C). Smooth out the silicone sealant using a suitable tool. Observe the instructions for use of the selected silicone sealant. Do not switch on the appliance until the silicone sealant has dried completely.



1. Silicone sealant
2. Sealing tape

### **WARNING!**

Pay particular attention to built-in dimensions with (natural) stone countertops. When choosing the silicone sealant, observe the countertop material and consult the countertop manufacturer. Use of inappropriate silicone sealants can result in permanent discolouration of some parts.

## Removing the built-in appliance

Disconnect the appliance from the power mains. Use a suitable tool to remove the silicone gasket from the perimeter. Remove the appliance by pushing it upwards from the bottom side.

### **WARNING!**

Do not attempt to remove the appliance from the upper side of countertop.

### **WARNING!**

The service department shall only be responsible for repair and servicing of the cooking hob. Consult your specialized kitchen equipment dealer regarding the re-installation (of the flush-mount) cooking hob.

**Stone countertop**

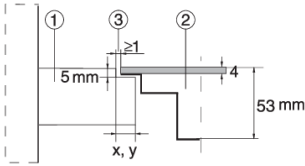

1. Countertop
2. Appliance
3. Slot

Given the margin of error (tolerance) for the glass ceramic plate of the appliance, and the cutout in the countertop, the slot is adjustable (min.2 mm).

**Ceramic, wooden, or glass countertop**

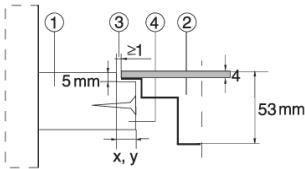

1. Countertop
2. Appliance
3. Slot
4. Wooden frame, thickness 16 mm

Given the margin of error (tolerance) for the glass ceramic plate of the appliance, and the cut-out in the countertop, the slot is adjustable (min. 2mm). Install the wooden frame 5.5mm below the upper edge of the countertop (see figure).

Observe the radii of glass edges (R10, R2) when making the cut-out.

GLASS

CUT-OUT

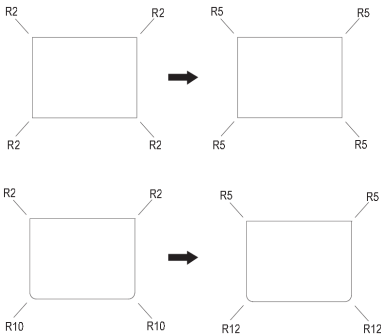

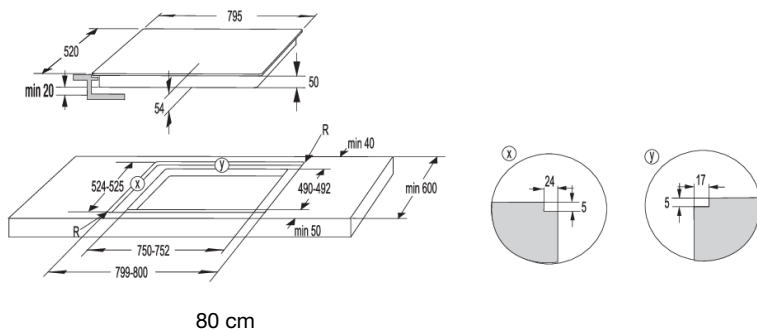
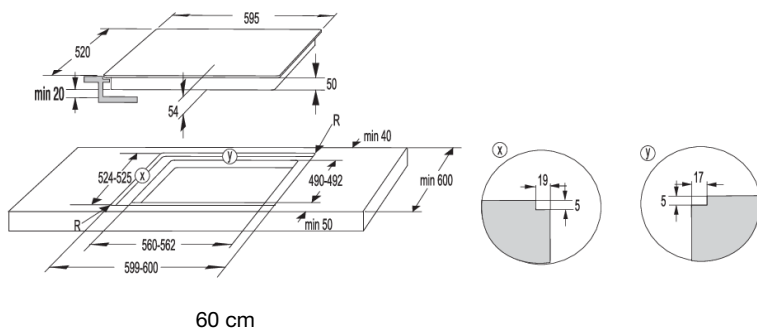
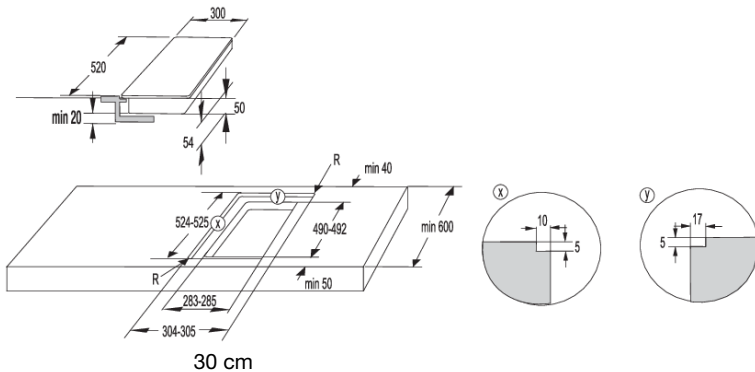

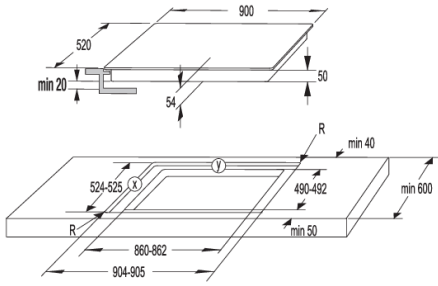

90cm

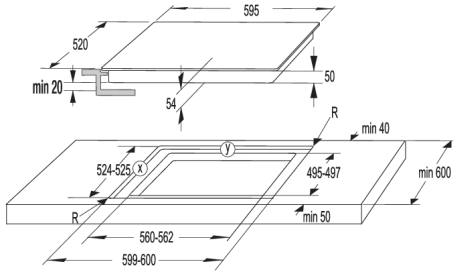
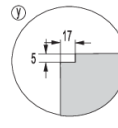
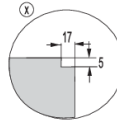

60 cm

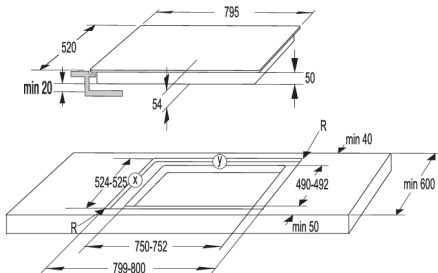
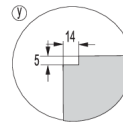
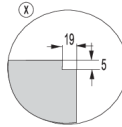

80 cm

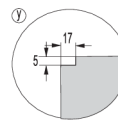
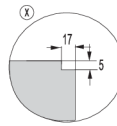
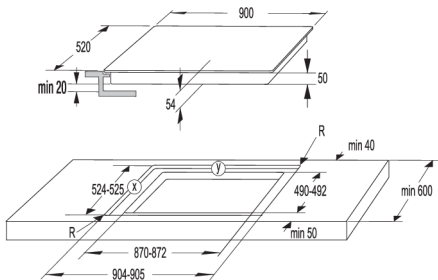
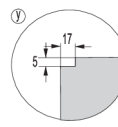
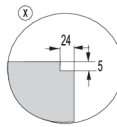

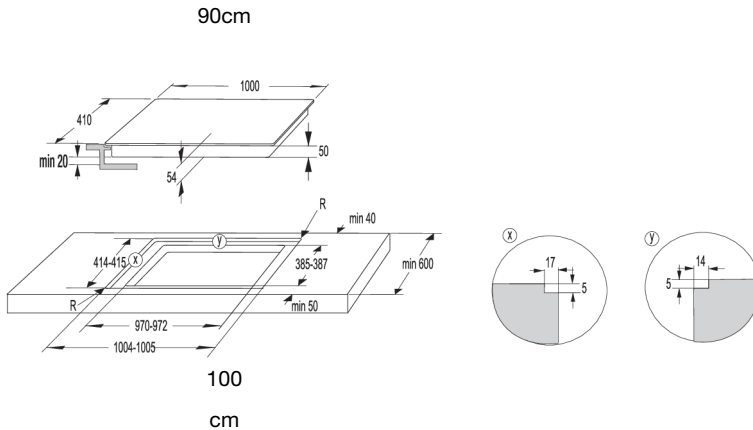

**WARNING!**

If the oven is installed under a flush-mounted cooking hob, then the worktop thickness should be at least 40 mm.

## Fitting the foam gasket



**INFORMATION!**

Some appliances come with the gasket already fitted!

Before installing the appliance into a kitchen worktop, attach the foam gasket supplied with the appliance to the bottom side of the glass ceramic hob. Remove the protective film from the gasket. Attach the gasket to the bottom side of the glass (2–3 mm away from the edge). The gasket has to be applied along the entire edge of the glass. The gasket may not overlap in the corners. When fitting the gasket, make sure it is not damaged by or in contact with any sharp objects.

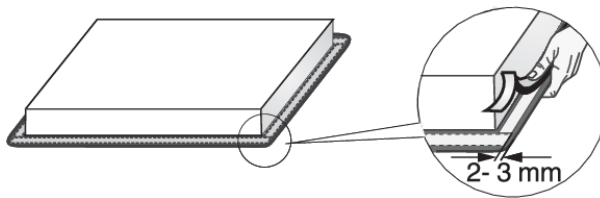

**WARNING!**

Do not install the appliance without the gasket!

# Connecting the cooking hob to the power mains

- Power mains protection must conform to the relevant regulations.
- Before connecting the appliance, make sure the voltage specified on the rating plate conforms to the voltage of the power mains.
- There should be a switching device in the electrical installation that can disconnect all poles of the appliance from the power mains, with a minimum clearance of 3 mm between the contacts when open. Suitable devices include fuses, protective switches etc.
- The connection should be adjusted to the current and fuses.
- After installation, the parts carrying electrical current and insulated parts shall be protected against contact.

## WARNING!

The appliance may only be connected by an authorised expert. False connection can destroy parts of the appliance. In such case, there is no right to warranty! Disconnect the appliance from the power mains before any repair or maintenance operation.

## Connection diagram

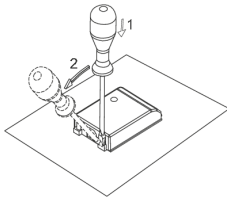

Jumpers (connecting bridges) are placed in the dedicated slot on the clamp.

The following may be used for connection:

- PVC insulated connection cables type H05 VV-F or H05V2V2-F with yellow-and-green protective conductor, or other equivalent or superior cables.
- Exterior cable diameter should be at least 8.00 mm.

### Normal connection:

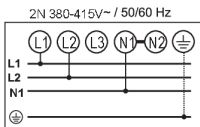

2 phases, 1 neutral conductor (2 1N, 380-415 V~/50/60 Hz):

- Voltage between phases and neutral conductor is 220-240 V~.
- Voltage between the two phases is 380-415 V~. Install a jumper between the terminals 4-5. The group should include at least two 16-ampere fuses. Diameter of the power cord core should be at least 2.5 mm<sup>2</sup>.

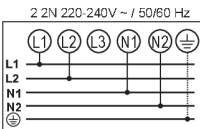

2 phases, 2 neutral conductors (2 2N, 220-240V~/50/60 Hz):

- Voltage between phases and neutral conductors is 220- 240 V~.
- The group (installation) should include at least two 16-ampere fuses. Diameter of the power cord core should be at least 2.5 mm<sup>2</sup>.

### Special connection:

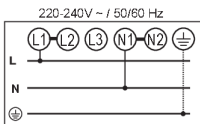

Single-phase connection (1 1N, 220-240 V~/50/60 Hz):

Voltage between phase and neutral conductor is 220-240 V~. Install jumpers between the terminals 1-2 and 4-5. The group (installation) should be fitted with a fuse of at least 32 A. Power cord core diameter should be at least 4 mm<sup>2</sup>.

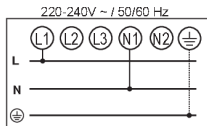

Run the power cord through a cord strain relief (clamp) which

False connection can destroy parts of the appliance. In such case, there is no right to warranty.



### WARNING!

Before connecting the appliance, make sure the voltage specified on the rating plate conforms to the voltage of the power mains. An expert should check the actual voltage in your home (220- 240 V relative to N), using a suitable meter!

Appliances with a width of 30 centimetres (two cooking zones) only allow single-phase connection. The cross-sectional area of the power cord core should be at least 1.5 mm<sup>2</sup>!

## Power cord

(appliance without a power cord)

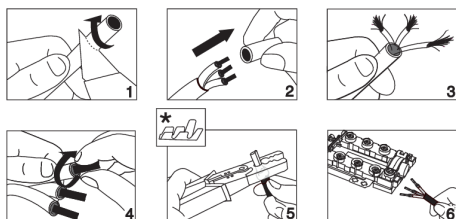

- The following may be used for connection:
- PVC insulated connection cables type H05 VV-F or H05V2V2-F with yellow-and-green protective conductor, or other equivalent or superior cables.
- Exterior cable diameter should be at least 8.00 mm.
- Run the power cord through a cord strain relief (clamp) which

\* Ferrules are not supplied.



### INFORMATION!

We recommend using electric wire ferrules (end terminals).



# Disposal



Our product packaging is made of environmentally friendly materials that can be recycled, disposed of, or destroyed without any hazard to the environment. To this end, packaging materials are labelled appropriately.

**The symbol** on the product or its packaging indicates that the product should not be treated as normal household waste. Take the product to an authorized collection centre for waste electric and electronic equipment processing.

Correct **disposal** of the product will help prevent any negative effects on the environment and health of people, which could occur in case of incorrect product removal. For detailed information on removal and processing of the product, please contact the relevant municipal body in charge of waste management, your waste disposal service, or the store where you bought the product.

*We reserve the right to any changes and errors in the instructions for use.*

**Hisense**



879496-a5

