

Contents

Your dishwasher	3	Power failure	21
Safety instructions	4	Once the program has finished	21
Child lock	5	The best drying results	22
Installation	5	Unloading the dishwasher	22
Overflow guard	5	Program chart	23
Packaging	5	Settings	24
Disposal	5	Care and cleaning	26
Symbols on the appliance	5	Top up rinse aid	26
Before washing for the first time	6	Top up salt	26
Water hardness	6	Clean the filters	26
Basic settings	7	Cleaning the spray arms	28
Top up rinse aid	8	Clean the outside of the dishwasher	29
Top up salt	8	Run Self-cleaning	29
Greener dishwashing	9	Remove blockages	29
Save energy and water	9	Winter storage/Transport	30
Loading the dishwasher	10	Troubleshooting	31
Fragile dishes	10	Installation	38
Loading affects the results	10	Safety instructions	38
The dishwasher's baskets	10	Setup	39
Top cutlery tray	11	Drainage connection	39
Upper basket	12	Connection to water supply	39
Lower basket	13	Electrical connection	40
Cutlery basket	15	Service	41
Using the dishwasher	17	Information about your product	41
Add detergent	17	Contact your nearest service centre	41
On/Off	18	Number of cycles	41
Select program	18	Technical data and energy labelling	42
Select program mode	19	Technical data	42
Select option	20	Information for consumers	42
Start/Stop	20	Information for test institute	42
Status light	21	Declaration of conformity	42
If you want to load more dishes	21		

Your dishwasher

Welcome to our growing ASKO family!

We are proud of our appliances. We hope that this appliance will be an appreciated and dependable aid for many years to come.

Please read the operating instructions before use. They include general tips, information about the settings and adjustments you can make, and the best way to take care of your appliance.

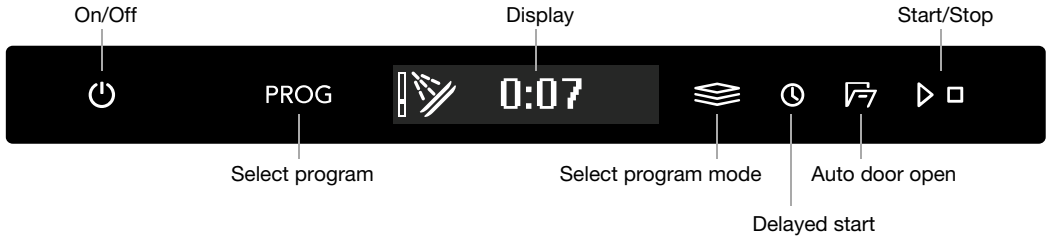

Symbols on the display:

- ☞ Auto door open
- * Top up rinse aid
- ☞ Top up salt

Text on the display:

- Clean the filters
- Run Self-cleaning
- See the chapter *Care and cleaning*.

Install the dishwasher, see the chapter *Installation*. Then open the door and press .

"Welcome to your ASKO. First time setup." is shown on the display the first time the dishwasher is switched on. It is important that you choose the right settings to ensure good dishwashing results. See page 6.

Safety instructions

- Read the user manual and keep it in a safe place!
- Number of standard place settings: 14
- Never use the dishwasher for any purpose other than that specified in these operating instructions.
- Do not load the dishwasher door or dishwasher baskets with anything other than dishes.
- Never leave the dishwasher door open as someone may trip on it. Push the baskets in to avoid risking the dishwasher tipping over.
- Use only dishwasher detergent!
- This machine can be used by children aged 8 and upwards, and by people with reduced physical capacity, mental ability, memory loss or lacking experience and knowledge. These individuals must be supervised when using the machine or have instructions on how to use the machine and understand the risks that can occur. Cleaning of the machine must not be carried out by children without supervision.
- Damaged supply cord must only be replaced by the manufacturer's service centre or someone similarly professionally qualified.
- Only use the dishwasher in household-type environments for dishwashing household dishes. All other use is prohibited.
- Never place dishes with solvent residues in the dishwasher due to the risk of explosion. Nor may dishes that contain ash, wax or lubricants be washed in the dishwasher.
- Children must be watched. Do not allow children to use or play with the dishwasher. Be especially vigilant when the door is open. Some detergent may remain inside! After adding detergent, always start the dishwasher immediately.



WARNING!

Knives and other pointed items must be placed with the points down in the cutlery basket or horizontally in other baskets.

WARNING!

Children must be supervised – dishwasher detergent is corrosive!

Child lock

You can activate the Automatic child lock setting to prevent children from starting the dishwasher. See the chapter *Settings*. You can also temporarily activate and deactivate the Child lock function. Press and hold  and  for three seconds.

Installation

See the chapter *Installation*.

Overflow guard

The overflow guard starts pumping out the water and turns off the water supply if the water level in the dishwasher exceeds the normal level. If the overflow guard is triggered, F54 (Overfilling water) appears on the display. Turn off the water tap and contact your nearest service centre. (To avoid water leakage outside the dishwasher, do not remove the plug from the wall socket until the water tap on the supply line has been turned off!)

Packaging

The outer packaging protects the product during transport. The packaging material is recyclable. Separate the different packaging materials to help reduce raw material use and waste. Your dealer can take the packaging for recycling or direct you to the nearest recycling centre. The packaging is comprised of:

- Corrugated cardboard made from up to 100% recycled material.
- Expanded polystyrene (EPS) with no added chlorine or fluorine.
- Supports made from untreated wood.
- Protective plastic made from polyethylene (PE).



Disposal

The dishwasher is manufactured and labelled for recycling. When the dishwasher has reached the end of its service life and is to be disposed of, it should immediately be made unusable. Pull out the power cable and cut it as short as possible.

Contact your local authority for information about where and how your dishwasher should be correctly recycled.

Symbols on the appliance

 Read the user manual.

  Recycle as electrical waste.

 Approved in accordance with the relevant EU directives.

 Approved in accordance with the relevant UK legal requirements.

Before washing for the first time

Water hardness

In order to achieve good dishwashing results, the dishwasher needs soft water (water with low mineral content). Hard water leaves a white coating on dishes and the dishwasher.

Checking water hardness

Water hardness is specified using German degrees of water hardness (°dH), French degrees of water hardness (°fH), English degrees of water hardness (°eH) or millimoles per litre (mmol/l).

A water supply with a water hardness in excess of 5°dH (9°fH / 6°eH / 0.9 mmol/l) must be softened. This is done automatically with the aid of the built-in water softener. In order for the water softener to function properly, its settings must be adjusted to the hardness of the water supply. Once you have adjusted the water softener settings, add detergent and rinse aid in doses suitable for soft water.

Contact the local waterworks to check the water hardness in your area.

Make a note of the water hardness: _____

°dH	°fH	°eH	mmol/l	Recommended setting
0-5	0-9	0-6	0.0-0.9	0
6-8	10-14	7-10	1.0-1.4	1
9-11	15-20	11-14	1.5-2.0	2
12-14	21-25	15-18	2.1-2.5	3
15-19	26-34	19-24	2.6-3.4	4
20-24	35-43	25-30	3.5-4.3	5
25-29	44-52	31-36	4.4-5.2	6
30-39	53-70	37-49	5.3-7.0	7
40-49	71-88	50-61	7.1-8.8	8
50	89	62	8.9	9

If the water hardness exceeds 50°dH (89°fH / 62°eH / 8.9 mmol/l), we recommend connecting an external water softener.

Increased consumption during regeneration

The dishwasher's built-in water softener is regularly regenerated to maintain its function. Regeneration extends the dishwashing program and increases energy and water consumption. Just how often the dishwasher's water softener is regenerated depends on the selected setting.

Example: If the Eco program is run with a water hardness of 14°dH (25°fH / 18°eH / 2.5 mmol/l), the water softener is regenerated at regular intervals (after 7 dishwashing cycles), energy consumption increases by 0.015 kWh, and water consumption increases by 2.3 litres, while the program time is extended by 3 minutes. Regeneration takes place during the program's main wash.

Before washing for the first time

WARNING!

Hard water leaves a white coating on dishes and inside the dishwasher. It is therefore important that you select the right setting for the water softener! See Water hardness.

Never run the dishwasher with an empty salt compartment if the water supply has a water hardness in excess of 5°dH (9°FH / 6°eH / 0.9 mmol/l).

Basic settings

Open the door. Press .

"**Welcome to your ASKO. First time setup.**" is shown on the display. It is important that you choose the right settings to ensure good dishwashing results.

Select setting with **PROG.** Confirm selected setting with .

Settings		
1.	Language	Select the language to be shown on the display.
2.	Set level of rinse aid 0/1/2/3/4/5 <i>Pre-selected at factory: 4</i>	Drying is faster and a better result is achieved if you use rinse aid. You will also achieve a better dishwashing result with clear and spotless dishes. The rinse aid dispenser can be adjusted between 0 (Off) and 5 (High dosage).
3.	Set water hardness 0/1/2/3/4/5/6/7/8/9 <i>Pre-selected at factory: 4</i>	Adjusting the water softener. Select a setting depending on the hardness of the water supply. It is important that this setting is correct! For a water supply with a hardness above 5 °dH (9 °fH / 6 °eH / 0.9 mmol/l), fill with salt. <i>For a water supply with a hardness below 6°dH (10°FH / 7°eH / 1.0 mmol/l), select 0. The water softener is deactivated and no salt needs to be added.</i>
4.	TAB On/Off (All-in-one detergent) <i>Pre-selected at factory: Off</i>	Activate this setting when using an all-in-one detergent that contains rinse aid. This setting reduces the rinse aid dosage and affects how often the dishwasher's built-in softener is regenerated.

To change the selected setting, see the chapter *Settings*.

Before washing for the first time

* Top up rinse aid

Top up the rinse aid compartment with rinse aid if you have selected Rinse aid 1 - 5.

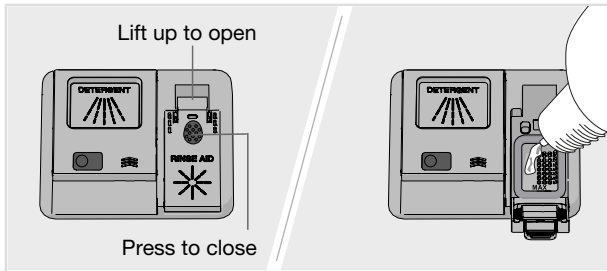

1. Open the rinse aid compartment lid.
2. Carefully top up with rinse aid to the level marked **MAX**.
3. Wipe up any splashes of rinse aid around the compartment.
4. Close the lid firmly.

§ Top up salt

For a water supply with a hardness above 5 °dH (9 °fH / 6 °eH / 0.9 mmol/l), fill with salt.

Add salt to the salt compartment if you have selected Water hardness 1 - 9.

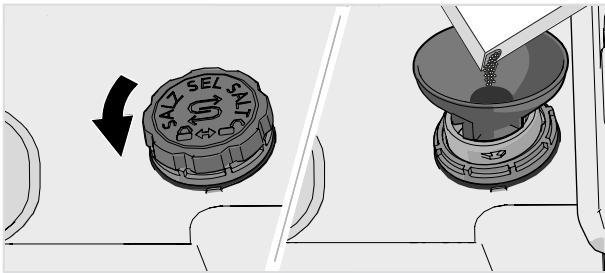

1. Remove the salt compartment lid by turning it anticlockwise.
2. Place the funnel supplied with the dishwasher in the salt compartment top-up hole. Before washing for the first time, pour in about 1 l of water. (Water is only needed the first time.)
3. Add enough salt to fill the salt compartment (max. 750 gram). Use special dishwasher salt.
4. Wipe away excess salt and turn the lid clockwise until in the closed position.

⚠ WARNING!

In order to avoid rust stains a dishwashing program must be started immediately after adding salt.

Never pour dishwasher detergent into the salt compartment. This destroys the water softener!

Save energy and water

When using a dishwasher in a residential setting, less energy and water are generally used compared to washing the dishes by hand.

Do not rinse under running water

Do not rinse the dishes under running water as this will lead to increased energy and water consumption. Simply scrape off large food particles before loading the dishwasher.

Choose a green detergent

Read the environmental declaration on the packaging!

Too much detergent, rinse aid and salt can result in less effective dishwashing and also entail greater environmental impact.

Run a fully loaded dishwasher

Save energy and water by waiting until the dishwasher is full before running a program (see number of standard place settings). Use the Rinse and hold program to rinse the dishes if there are any unpleasant odours.

You can also use the Anti-odour program to prevent bad odours from dirty dishes left in the dishwasher.

Run programs at a lower temperature

If the dishes are only slightly dirty, you can select a program with a low temperature.

Select dishwashing program – Eco

This program is suitable for washing normally soiled dishes and is the most effective program in terms of combined energy and water consumption. This program is used to assess compliance with EU legislation on ecodesign.

The dishwashing program is designed for an effective wash using as little energy and water as possible. The program washes at a low temperature for a long time.

Select option – Auto door open

Better drying results are achieved if you use the Auto door open option, which automatically opens the dishwasher door. Wait until the dishwasher indicates that the programme has ended and the dishes have cooled before unloading the dishwasher.

Connect to cold water

Connect the dishwasher to the cold water supply if the building is heated using oil, electricity or gas.

Connect to hot water

Connect the dishwasher to the hot water supply (max. 70 °C) if the building is heated using an energy-efficient means such as district heating, solar power or geothermal power. Choosing a hot water connection reduces the dishwasher's energy consumption.

NOTE!

Do not exceed the permitted water supply temperature. Certain materials used in some cookware cannot withstand high heat. See *Fragile dishes* in the chapter *Loading the dishwasher*.

Loading the dishwasher

Fragile dishes

Some cookware is not dishwasher safe. This can be for several reasons. Some materials cannot withstand high heat, others can be damaged by dishwasher detergent.

Exercise caution with, for example, handmade items, fragile decoration, crystal/glassware, silver, copper, tin, aluminium, wood and plastic. Look for the "Dishwasher safe" marking.

Fragile decoration

Porcelain with decoration on top of the glazing (the items feel rough) should not be washed in a dishwasher.

Crystal/Glass

Drying is faster and a better result is achieved if you use rinse aid. You will also achieve a better dishwashing result with clear and spotless dishes.

Hand-painted glassware, as well as antique and very fragile items, should not be washed in a dishwasher.

Silver

Silver and stainless steel items should not come into contact, as the silver can become discoloured.

In order to avoid marks and tarnishing, separate dishes made from different metals, such as silver, stainless steel and aluminium.

Aluminium

Aluminium can lose its shine if washed in a dishwasher. However, good quality aluminium pans can be washed in a dishwasher, even if some of the shine will be lost.

Cutlery with glued handles

Some types of glue are not dishwasher safe. In such cases, the handles may loosen.

Loading affects the results

Load the dishes carefully to ensure the best washing and drying results with the lowest possible energy and water consumption. Give your dishwasher the best chance to reach and clean all surfaces, as well as to dry the dishes as thoroughly as possible.

- All dirty surfaces should face inwards and downwards!
- Dishes should not be placed in or on each other.
- Angle dishes with hollows, such as cups, so that the rinse water will run off. This is also important for plastic items.
- Make sure small items cannot fall through the dishwasher basket; place them in the top cutlery tray.

NOTE!

Check that the spray arms can rotate freely.

The dishwasher's baskets

The dishwasher is equipped with a top cutlery tray, an upper basket and a lower basket with a cutlery basket.

The appearance of the baskets may differ depending on the dishwasher setup.

Top cutlery tray

The top cutlery tray has space for cutlery, ladles, whisks, serving cutlery and similar items.

Avoid placing tall objects in the top cutlery tray. They can block the top spray arm.

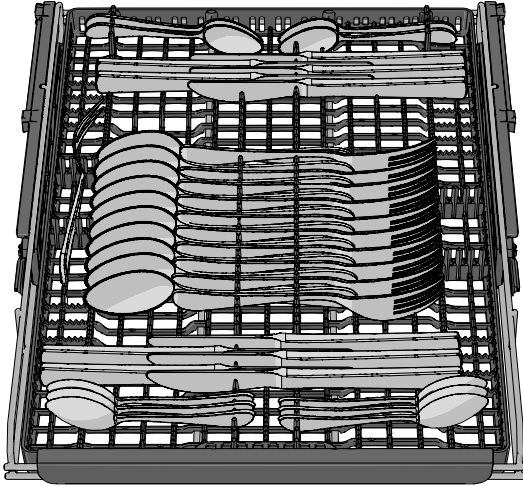

Raising the top cutlery tray

1. Pull out the top cutlery tray.
2. Pull forward the two locking handles on either side to raise the top cutlery tray.

Lowering the top cutlery tray

1. Pull out the top cutlery tray.
2. Slide the two locking handles on either side downwards and backwards to lower the top cutlery tray.

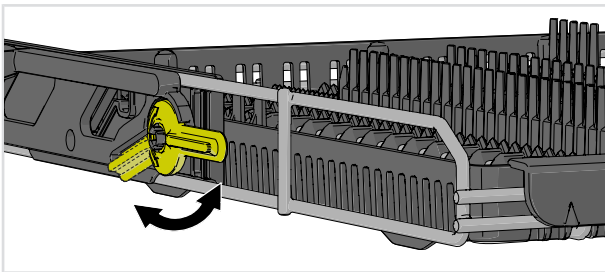

Loading the dishwasher

Upper basket

Place glasses, cups, bowls, side plates and saucers in the upper basket. All dirty surfaces should face inwards and downwards! Wine glasses are placed on the wine glass shelf and knives are placed in the knife stand on the right.

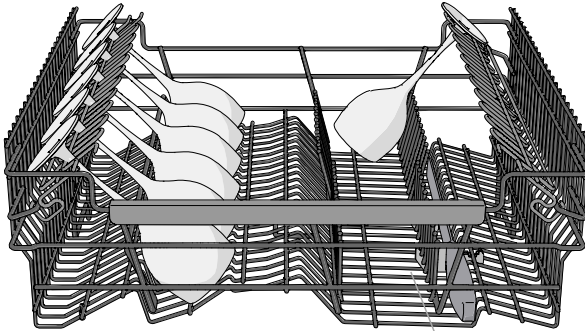
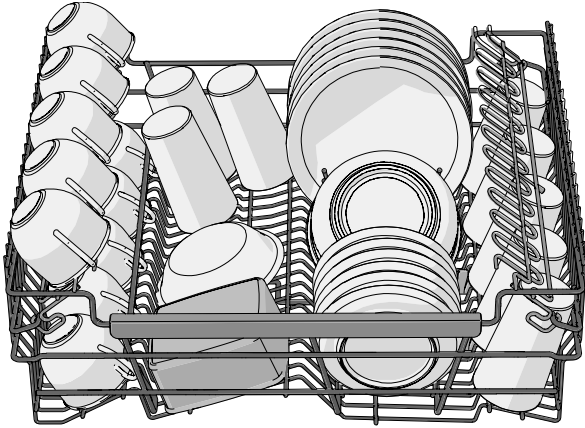

Knife stand

Raising and lowering the upper basket

1. Pull out the upper basket. (The basket must be empty.)
2. Turn the basket catch outwards at the end of both runners.
3. Grip the upper basket with both hands, pull it out and move the upper basket to its other position.
4. Turn back the basket catch at the end of both runners.

Loading the dishwasher

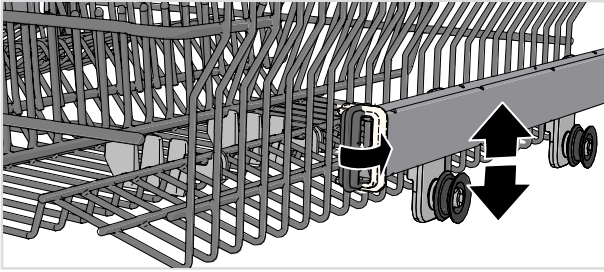

Lower basket

Place plates, side plates, serving dishes, pots and cutlery (in the cutlery basket) in the lower basket.

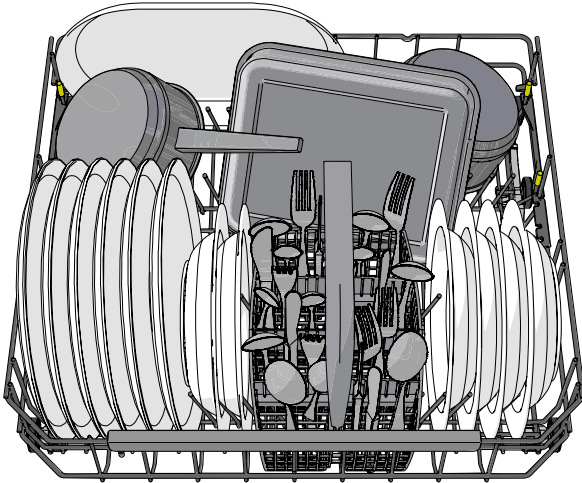

Adjustable plate supports

The adjustable plate supports can be adjusted to suit the dishes. Release the plate supports by pushing them inwards before repositioning them. The plate supports can also be folded down to make it easier to load pots and bowls.

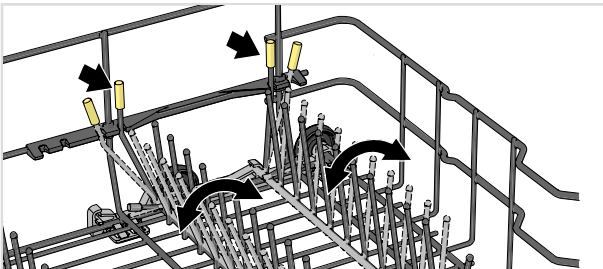

Loading the dishwasher

Adaptable power zones

The dishwasher's two adaptable power zones can be opened in two different positions or turned off.

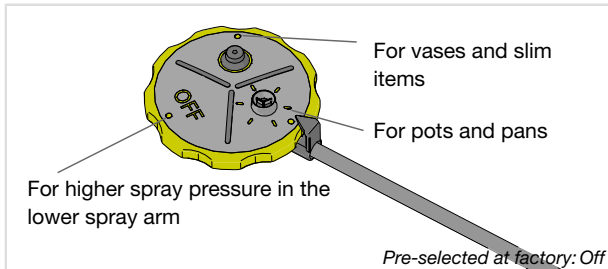

Leave the power zones open if you want an increased water flow where, for example, you have placed pots and pans or vases and slim items. Turn the dishwasher's power zones off if you want greater spray pressure in the lower spray arm.

Accessory

Buy a vase and bottle holder. This accessory is available where you bought the dishwasher.

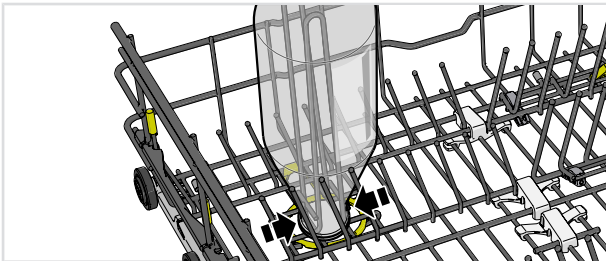

Washing large plates

You can adjust the lower basket for plates with a diameter of 25-31 cm by moving the adjustable plate supports and their fixtures to increase the distance between the tine rows.

Accessory

Buy a wine glass shelf with space for six tall¹⁾ wine glasses. The wine glass shelf is designed to ensure optimal washing and drying results with tall wine glasses. The wine glass shelf is placed in the rear section of the lower basket. This accessory is available where you bought the dishwasher.

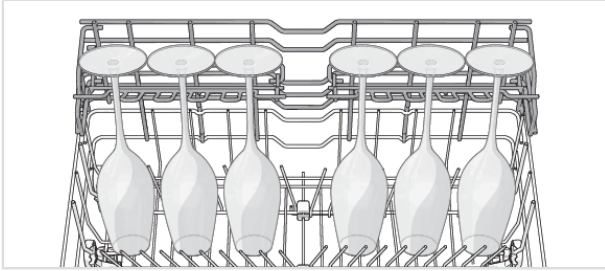

Cutlery basket

Place cutlery with the handles facing down, except for knives, and spread them out as much as possible. Ensure that spoons do not stack inside each other.

The cutlery basket is best placed in the middle at the front of the lower basket to best utilise dishwashing performance from the unique spray zone intended for the cutlery basket.

WARNING!

Knives and other pointed items must be placed horizontally in the dishwasher's special cutlery baskets.

Fold-down section for small items

The cutlery basket has a fold-down section in the middle for small items or small shafts (such as electric whisk attachments).

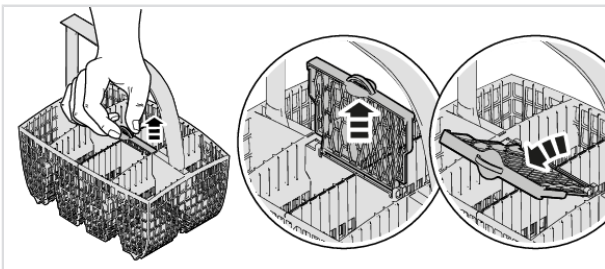

¹⁾ Height: max. 25 cm, Diameter: max. 7.5 cm

Loading the dishwasher

Accessory

Buy a mini cutlery basket. The extra cutlery basket is flexible and can be dismantled and attached to the lower basket or the large cutlery basket to make an extra large cutlery basket. This accessory is available where you bought the dishwasher.

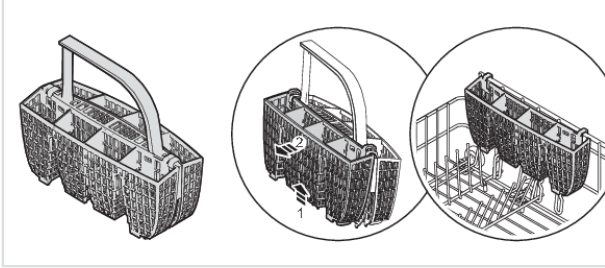

Add detergent

Follow the instructions on the detergent packaging. This dishwasher is fitted with a water softener, so use detergent and rinse aid doses suitable for soft water.

Too much detergent can result in less effective dishwashing and also entails greater environmental impact.

Detergent compartment

The detergent compartment must be dry when adding detergent.

If powder or liquid dishwasher detergent is used, add a small amount of the detergent to the compartment for prewash detergent.

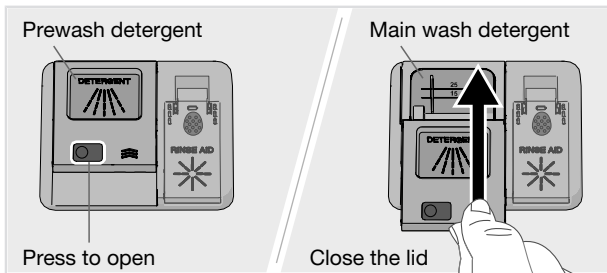

NOTE!

Use only dishwasher detergent! Washing up liquid must not be used as the foam that forms prevents the dishwasher from operating effectively.

All-in-one detergent

There are many types of all-in-one detergents on the market. Read through the directions for these products carefully.

Activate the TAB setting when using an all-in-one detergent that contains rinse aid.

Dishwasher tablets are not recommended for short programs (less than 75 minutes). Use powder or liquid dishwasher detergent instead.

NOTE!

Optimal washing and drying results are achieved by using normal detergent together with separately dispensed rinse aid and salt.

Contact the detergent manufacturer if you have questions about the detergent.

Using the dishwasher



On/Off

Open the door and press . Also turn on the water tap if it is turned off.

PROG Select program

Eco is always pre-selected. To select another program, press **PROG** until the desired program is shown on the display.

Select a program to suit the type of dishes and how dirty they are.

Eco

This program is suitable for washing normally soiled dishes and is the most effective program in terms of combined energy and water consumption. This program is used to assess compliance with EU legislation on ecodesign.

You can read more about greener dishwashing in the chapter *Greener dishwashing*.

For heavily soiled dishes with a lot of grease, a program with higher temperatures should be used.

Universal

An effective program for daily use for slightly dried leftovers. (This program is not intended for burnt food, such as on oven dishes.)

Intensive

A program with a high temperature for dissolving grease on very dirty dishes, such as pans, casserole dishes and oven dishes. If these dishes do not completely fill the dishwasher, you can add plates and other dishes.

Quick²⁾

A fast and effective program for slightly dried leftovers. (This program is not intended for burnt food, such as on oven dishes.)

The Auto door open option is important for ensuring the best drying results.

²⁾ When combined with Speed, the program is shortened (60 minutes).



Time program

The program adapts to the specified running time or finish time. With this program it is important to choose a time suited to how dirty the dishes are.

Press  to set the desired program time.

0:15-0:45	Slightly dirty dishes
1:00-1:30	Normally dirty dishes
2:00-2:30	Very dirty dishes



Hygiene

This program is ideal to use where demands on hygiene are extra high, e.g. for baby bottles and cutting boards. The temperature is high both in the main wash and in the final rinse.



Rinse and hold

Used to rinse dishes while you wait for the dishwasher to become fully loaded.



Self-cleaning

Self-cleaning program for hygienic cleaning of the dishwasher tub, spray arms and spray pipes.

This program should be run (with no dishes in the machine) using normal dishwasher detergent or citric acid. Special dishwasher cleaners are also available on the market. For the removal of limescale deposits, see *Dishwasher tub* in the chapter *Care and cleaning*.

72h

Anti-odour³⁾

This program prevents bad odours from dirty dishes left in the dishwasher. Only the dishwasher's fan is activated (at regular intervals during a period of 72 hours).



Select program mode

Press  to scroll through the available program modes. The symbol is dimly lit in available program modes, and glows brighter when a program mode has been activated. (The program modes you can select vary between programs.)

▶▶ Speed

The program time is shortened, but the dishwasher uses more energy.



☾ Night

Lower noise level during the dishwashing program. The program time is extended.

³⁾ Activate Odour control in the dishwasher's Settings menu. See the Settings chapter.

Using the dishwasher

Select option

Available options are dimly lit. Select the options ( , ) to activate them. The options glow brighter when activated. (The options you can select vary between programs.)

Auto door open

The dishwasher door opens automatically, which shortens the program time and improves the drying results. Wait until the dishwasher indicates that the program has ended and the dishes have cooled before unloading the dishwasher.

The drying time of the Auto door open option varies (from 5 to 90 minutes) depending on the model, program and temperature of the final rinse.

The Auto door open option is pre-selected for some programs.

NOTE!



For the best drying results, do not close the door before the drying phase has finished and the machine has automatically switched off.

WARNING!

The dishwasher door must not be blocked or closed when opened automatically. Doing so may damage the door lock mechanism. Wait at least 5 minutes before closing the door.

Delayed start

When you select Delayed start, the dishwasher will start 1-24 hours after you have pressed  and closed the door.

1. Press  once to activate Delayed start. Press several times, or hold it in, to set the desired number of hours.
2. Press  and close the door. The timer counts down and the dishwasher starts after the selected delay.



If you want to cancel the Delayed start option, open the door then press and hold  for three seconds.

Start/Stop

Press  until the display shows "Program started". This indicates that the dishwasher is ready to start. Close the door properly, otherwise the dishwasher will not start.

If the dishwasher is not started or the door is not closed within 2 minutes of the last time the control panel was pressed, the machine switches off.

Stopping or changing a program

If you want to change program after starting the dishwasher, open the door then press and hold  for three seconds. Add more detergent if the lid of the detergent dispenser has opened. Then select a new program, press  and close the door.

Remaining time

Once you have selected a program, program mode and options, the time the program took when last used is displayed.

Status light

The status light at the bottom on the dishwasher provides information by means of 3 different colours.

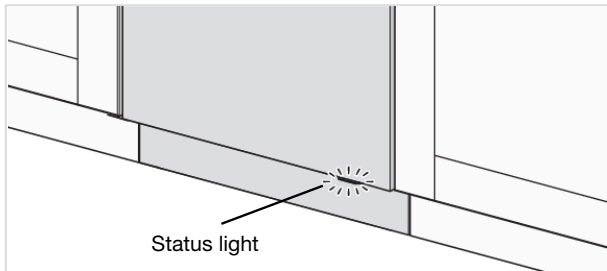

Blue - Load more

The program has started, but you can still load more dishes.

Red - Do not load

You should not load more dishes (risk of poorer dishwashing result).

Green - Unload

The dishwashing program is finished. The status light stays on for 15 minutes.

Flashing red

A flashing light indicates that the door has been opened while a program is in progress. If it flashes when the door is closed, an error has occurred. See the chapter *Troubleshooting*.

If you want to load more dishes⁴⁾

Open the door. The dishwasher stops automatically. Add the dishes and close the door. After a while, the dishwasher continues the program.

Power failure

If the dishwasher is turned off due to a power failure when a dishwashing program is running, the program continues when power is restored. If the power is cut during drying, the program is interrupted.

If you open the door for more than 2 minutes during drying, the program will be interrupted.

Once the program has finished

The end of the program is indicated by one short signal from the buzzer. The chapter *Settings* describes how to change this function.

Moreover, the end of the program is indicated by the status light turning green.

Once the dishwasher door is opened and the program has finished "Program done" appears on the display.

The dishwasher switches off automatically after the program ends. Shut off the water tap after each use (if required by your insurance company).

⁴⁾ You should not load more dishes if the status light is red.

Using the dishwasher

The best drying results

- Fully load the dishwasher.
- Angle dishes with hollows, such as cups, so that the rinse water will run off. This is also important for plastic items.
- Top up with rinse aid or increase the rinse aid dosage setting.
- Activate the Auto door open option.
- Allow the dishes to cool before unloading the dishwasher.

Unloading the dishwasher

Hot porcelain is more fragile. Leave the dishes to cool in the dishwasher before unloading them.

Unload the lower basket first to avoid any water drops from the upper basket falling onto the dishes in the lower basket.

Program	Program mode / Option	Number of prewashes	Main wash	Number of rinses	Final rinse	Consumption values 1)				
						Cold water 2)		Hot water 3)		Water cons. (liter)
						Dishwashing time (approx. hrs:min)	Energy (approx. kWh)	Dishwashing time (approx. hrs:min)	Energy (approx. kWh)	
Eco 4)	5)		49 °C	2	47 °C	3:15	0.64	3:05	0.3	9.2
Universal	5)	1	60 °C	2	60 °C	2:40	1.1	2:20	0.7	12.5
Intensive		2	70 °C	2	70 °C	2:50	1.6	2:30	1.2	16.0
Quick	5)		65 °C	3	65 °C	1:30	1.3	1:30	0.9	14.5
Time program		0-2	<65 °C	2	<65 °C	0:15-2:30	0.3-1.4	0:15-2:30	0.2-1.0	10.0-16.5
Hygiene			70 °C	2	70 °C	1:05	1.3	0:45	0.9	10.5
Rinse and hold				1		0:07	0.01	0:07	0.01	3.5
Self-cleaning			70 °C	2	70 °C	1:05	1.0	0:45	0.6	10.0
Anti-odour						72:00	0.2	72:00	0.2	

1) Consumption values vary depending on the temperature of the incoming water, room temperature, load size, selected additional functions and more. The values for the Eco program are accurate, others are indicative only.

2) Connection to cold water, approx. 15 °C.

3) Connection to hot water, approx. 60 °C.

4) This program is suitable for washing normally soiled dishes and is the most effective program in terms of combined energy and water consumption. This program is used to assess compliance with EU legislation on ecodesign.

5) Auto door open



Settings

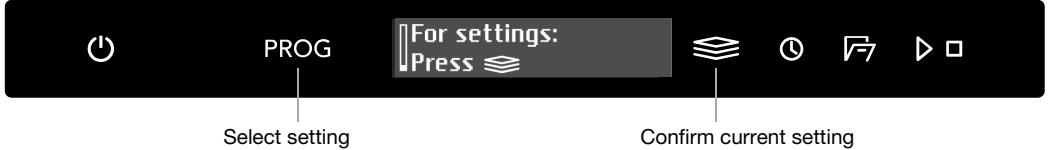

Open the door and press .

To open the dishwasher's Settings menu, press **PROG** until  Settings menu is shown on the display and confirm your selection with .

To exit the dishwasher's Settings menu, select Exit and confirm your selection with .

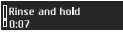
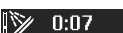

Settings		Alternatives	
1.	Language		You can choose the language used for the display.
2.	Automatic child lock	<i>On/Off</i>	You can activate the Automatic child lock setting to prevent children from starting the dishwasher. To temporarily deactivate or activate the Automatic child lock setting, press and hold  and  for three seconds.
3.	Display	Logotype <i>On/Off</i>	Setting to hide the logo shown on the display.
		Contrast <i>1/2/3/4</i>	For adjusting the contrast of the display.
		Program Info screen <i>T/S</i>	You can select which information is shown on the display.  T-Text  S-Symbol
4.	Sound	Feedback <i>0/1/2/3</i>	A beep confirms that the control panel has been pressed.
		Notification <i>0/1/2/3</i>	The buzzer indicates when a dishwashing program has ended. <i>Error messages are always indicated by a loud buzzer.</i>
5.	Rinse aid	<i>0/1/2/3/4/5</i>	Setting for rinse aid dosage. The rinse aid dispenser can be adjusted between 0 (Off) and 5 (High dosage). Increase the rinse aid dosage: <ul style="list-style-type: none"> If the dishes have water marks. Decrease the rinse aid dosage:

Settings	Alternatives	
		<ul style="list-style-type: none"> • If the dishes have a sticky white/blue film. • If the dishes are streaked. • Build-up of foam. If you have very soft water, the rinse aid can be diluted 50:50 with water.
6. Water hardness	<i>0/1/2/3/4/5/6/7/8/9</i>	<p>Adjusting the water softener. Select a setting depending on the hardness of the water supply. It is important that this setting is correct!</p> <p>See <i>Water hardness</i> in the chapter <i>Before washing for the first time</i>.</p> <p>For a water supply with a hardness above 5 °dH (9 °fH / 6 °eH / 0.9 mmol/l), fill with salt.</p> <p>For a water supply with a hardness below 6 °dH (10 °fH / 7 °eH / 1.0 mmol/l), select 0.</p> <p>The water softener is deactivated and no salt needs to be added.</p>
7. TAB (All-in-one detergent)	<i>On/Off</i>	<p>Activate this setting when using an all-in-one detergent that contains rinse aid.</p> <p>This setting reduces the rinse aid dosage and affects how often the dishwasher's built-in softener is regenerated.</p>
8. Super rinse	<i>On/Off</i>	<p>The Super rinse function rinses the dishes an extra two times.</p> <p>The program time is extended and the dishwasher uses more energy and water.</p> <p><i>Activated in the following programs:</i></p> <p><i>Universal</i></p> <p><i>Intensive</i></p> <p><i>Quick</i></p> <p><i>Hygiene</i></p>
9. Odour control	<i>On/Off</i>	<p>When Odour control is activated,  Anti-odour can be selected from the program table.</p>
10. Failure readout		<p>Any error messages.</p> <p><i>When contacting your service centre, you may be asked to provide the most recent error messages.</i></p>
11. Factory reset		<p>Restores all settings to the factory defaults.</p> <p>Select Factory reset and press .</p>
12. Exit		<p>To exit the dishwasher's Settings menu, select Exit and press .</p>

Care and cleaning

* Top up rinse aid

When the rinse aid needs topping up, the symbol lights on the display.

See the chapter *Before washing for the first time*.

⌘ Top up salt

When the salt needs topping up, the symbol lights on the display.

See the chapter *Before washing for the first time*.

Clean the filters

Coarse filter

The coarse filter traps larger food particles, which cannot get past the drainage pump. Empty the coarse filter when necessary. It should be cleaned at regular intervals depending on how often the dishwasher is used.

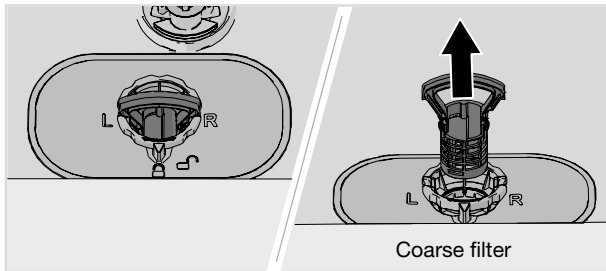

1. Lift the coarse filter by the handle.
2. Empty the coarse filter.
3. Refit the coarse filter. Press it down until it clicks into place.

Fine filter

Debris that collects on the fine filter is automatically rinsed away during each wash. Clean the fine filter when necessary. It should be cleaned at regular intervals depending on how often the dishwasher is used.

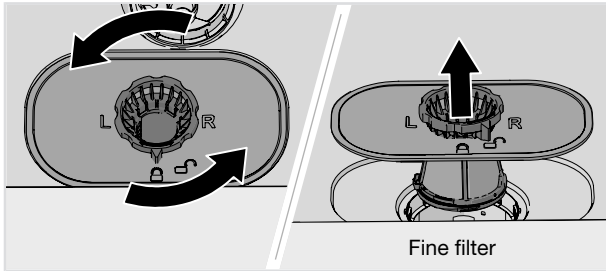

1. Turn the locking ring anticlockwise and lift the fine filter straight up.
2. Clean the fine filter.
3. Refit the fine filter and turn the locking ring clockwise to its stop position. Check that the edges seal properly.

Remember to refit the coarse filter!

NOTE!

Dishwashing results may be affected if the coarse and fine filters are incorrectly fitted. The dishwasher must not be used without the filters in place!

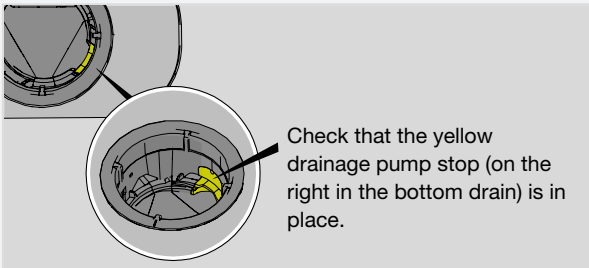

Care and cleaning

Cleaning the spray arms

Holes and bearings can sometimes become blocked. Remove any debris using a pin or the like. The spray arms also have holes underneath.

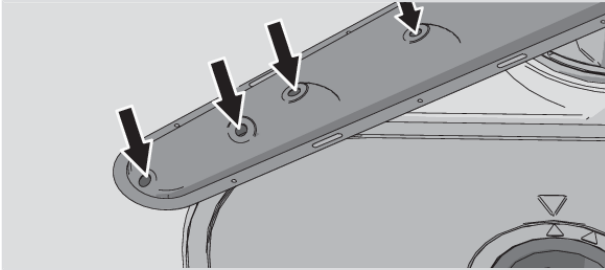

To facilitate cleaning you can remove the spray arms. Remember to fit them firmly back into place afterwards.

Top spray arm

- Pull out the top cutlery tray. Push up on the top spray arm while turning it anticlockwise to release it.

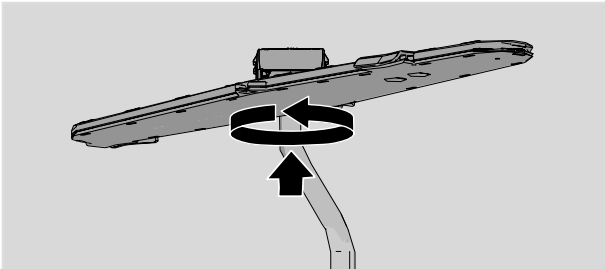

Upper spray arm

- Pull out the upper basket.
- Unscrew the spray arm bearings anticlockwise to remove the spray arm from the upper basket.

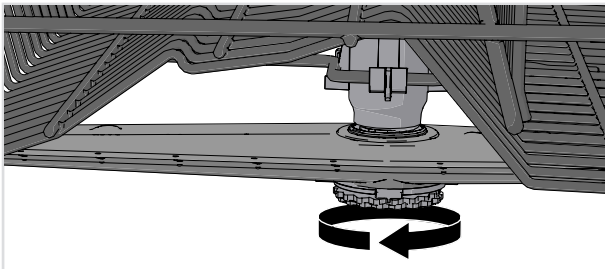

Lower spray arm

- Pull the lower spray arm straight up to release it.

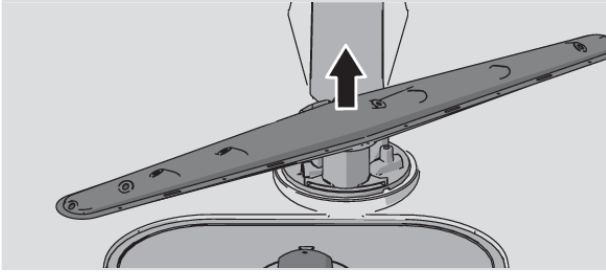

Clean the outside of the dishwasher

Door and door seal

Open the door. Clean the sides of the door and the door seal regularly with a slightly damp cloth. Clean the door seal at the lower front edge of the dishwasher with a washing-up brush.

Control panel

Keep the control panel clean. If necessary, wipe it with a dry or slightly damp cloth. Never use cleaning products – they may scratch the surface.

Run Self-cleaning

Dishwasher tub

The dishwasher tub is made of stainless steel and is kept clean through normal use (when used regularly).

If you have hard water, limescale deposits may build up in the dishwasher. If this happens, run the Self-cleaning program with two tablespoons of citric acid in the detergent compartment (with no dishes in the machine). Special dishwasher cleaners are also available on the market.

Remove blockages

Unblocking the drainage pump

If the dishwasher still contains water after the program has finished, something may be blocking the drainage pump, which results in the error message Water outlet fault or BLDC drain pump fault.

1. Turn off the machine using  and remove the plug from the wall socket.
2. Remove the coarse filter and the fine filter.
3. Scoop out the water from the dishwasher tub.
4. In order to inspect the drainage pump, remove the yellow drainage pump stop on the right in the bottom drain. (Use a pair of pliers if necessary.)
5. Turn the pump wheel located behind the drainage pump stop by hand. Carefully remove any sharp items, such as glass.
6. Refit the drainage pump stop along with the fine and coarse filters.
7. Plug the machine in again.

Care and cleaning

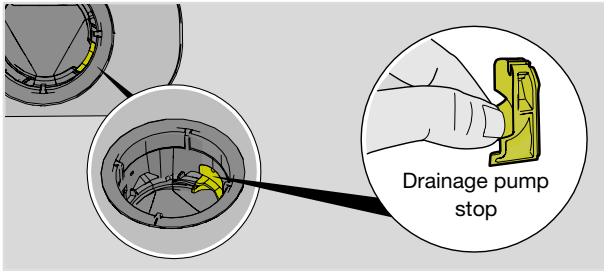

NOTE!

Do not forget to refit the drainage pump stop.

Unblocking the inlet hose filter

If the water supply contains small particles, the outer filter on the inlet hose may become blocked, which results in the Water inlet fault error message.

1. Turn off the machine using  and remove the plug from the wall socket.
2. Turn off the water tap.
3. Unscrew the inlet hose.
4. Carefully remove the outer filter from the inlet hose and clean it.
5. Refit the filter and check that the gasket is correctly positioned.
6. Screw the inlet hose firmly into place.
7. Plug the machine into the wall socket and turn on the water tap. Allow the pressure to settle for a while and check that the connection is watertight.

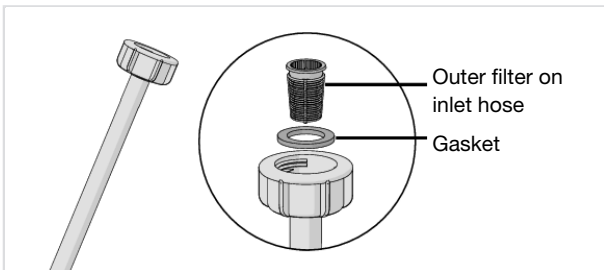

Winter storage/Transport

Store the dishwasher above freezing temperature and avoid long transport distances in very cold weather. Transport the dishwasher upright or laying on its back.

Before transporting a used dishwasher, or before prolonged storage, water must first be removed from the machine. Run the Self-cleaning program.

Error messages		Action
F10	Overfilling water 1	Unblocking the drainage pump. See the chapter <i>Care and cleaning</i> . If the problem persists, contact your nearest service centre.
F11	Water outlet fault	See "Water remains in the dishwasher" under "Problem" in the table below. If the problem persists, contact your nearest service centre.
F12	Water inlet fault 1	Check that the water tap is on. Check that the outer filter on the inlet hose is not blocked. See <i>Unblocking the inlet hose filter</i> in the chapter <i>Care and cleaning</i> . If the problem persists, contact your nearest service centre.
F40	Inlet valve leakage	Turn off the water tap and contact your nearest service centre.
F41	Heater fault 1	Turn off the water tap. Remove the plug from the wall socket and contact your nearest service centre.
F45	Diverter fault	Contact your nearest service centre.
F52	Water level fault	Clean the coarse and fine filters. Check that the outer filter on the inlet hose is not blocked. If the problem persists, contact your nearest service centre.
F54	Overfilling water 2	Turn off the water tap and contact your nearest service centre. To avoid water leakage outside the dishwasher, do not remove the plug from the wall socket until the water tap on the supply line has been turned off!
F56	Circulation pump fault	Contact your nearest service centre.
F67	Water inlet fault 2	Check that the water tap is on. Check that the outer filter on the inlet hose is not blocked. See <i>Unblocking the inlet hose filter</i> in the chapter <i>Care and cleaning</i> . If the problem persists, contact your nearest service centre.
F68	BLDC drain pump fault	See "Water remains in the dishwasher" under "Problem" in the table below. If the problem persists, contact your nearest service centre.

Press any button to clear the error message.

Troubleshooting

Problem	Possible causes	Action
The control panel does not react when pressed.	You have pressed the control panel too soon after opening the door.	Wait a moment then try again.
	Child lock or Automatic child lock is activated.	See the chapter <i>Safety instructions</i> .
	The door is closed.	Open the door. The control panel only reacts to use when the door is open.
	Dirt on the control panel.	Clean with a dry or slightly damp cloth.
	The control panel requires calibration.	Turn off the water tap. Remove the plug from the wall socket and wait for 60 seconds. Then plug the appliance back into the wall socket and turn on the water tap.
Cannot close door.	The baskets are not correctly positioned.	Check that the baskets are correctly positioned horizontally.
		Check that the dishes are not blocking the baskets from sliding properly into place.
	The door lock does not click into place and lock.	<p>Check the door lock. If it does not click into place and lock, open the door.</p> <p>Press and hold PROG and  until the display starts flashing. Wait until it stops flashing (60 seconds). Close the door. Check that the door lock clicks into place and locks.</p>

Problem	Possible causes	Action
The dishwasher does not start.	▷ □ has not been pressed.	Press ▷ □ until the display shows "Program started".
	The door is not properly closed.	Check.
	You have opened the dishwasher to add more dishes while a program is in progress.	Close the door and wait. After a while, the dishwasher continues the program.
	The door lock has not clicked into place and locked.	<p>Check the door lock. If it has not clicked into place and locked, open the door.</p> <p>Press and hold PROG and ↵ until the display starts flashing. Wait until it stops flashing (60 seconds). Close the door. Check that the door lock clicks into place and locks and the dishwasher starts.</p>
	Check whether the Delayed start option has been selected.	Press and hold ▷ □ for three seconds if you want to cancel the Delayed start option.
	The plug is not plugged into the wall socket.	Check.
	A fuse/circuit breaker has been tripped.	Check.

Troubleshooting

Problem	Possible causes	Action
The dishes are not clean.	The spray arms do not rotate.	Check that the dishes are not blocking the spray arms.
	Spray arm holes or bearings blocked.	Clean the spray arms. See the chapter <i>Care and cleaning</i> .
	Unsuitable dishwashing program.	Select a program with a high temperature to dissolve grease on very dirty dishes, such as Intensive.
	Incorrect detergent dosage.	Dose according to water hardness. Far too much or far too little detergent results in poorer dishwashing results.
	Old detergent. Detergent is a perishable product.	Avoid large packages.
	Dishes loaded incorrectly.	Do not cover porcelain with large bowls or the like. Avoid placing very tall glasses in the corners of the baskets. See the chapter <i>Loading the dishwasher</i> .
	Glasses and cups have toppled over during the program.	Place dishes to sit steady.
	The filters are clogged.	Clean the coarse and fine filters.
	The filters are not fitted correctly.	Check that the filters are fitted correctly. See the chapter <i>Care and cleaning</i> .
Spots on stainless steel or silver.	Drainage pump stop missing.	Check that the yellow drainage pump stop (on the right in the bottom drain) is in place. See the chapter <i>Care and cleaning</i> .
	Some foodstuffs, such as mustard, mayonnaise, lemon, vinegar, salt and dressings, can cause spots on stainless steel if left for too long.	Rinse off these types of foodstuffs if not starting the dishwasher immediately. Use the Rinse and hold program.
	All stainless steel can cause spots on silver if they come into contact during dishwashing. Aluminium can also cause spots on dishes.	In order to avoid marks and tarnishing, separate dishes made from different metals, such as silver, stainless steel and aluminium.

Problem	Possible causes	Action
Spots or films on the dishes.	Incorrect rinse aid dosage setting.	See the chapter <i>Settings</i> .
	The setting TAB is activated and all-in-one detergent with insufficient drying effect is being used.	Switch all-in-one detergents or deactivate the setting TAB and top up with salt and separate rinse aid. See Rinse aid in the chapter <i>Settings</i> .
	Salt compartment empty.	Top up with salt. See the chapter <i>Care and cleaning</i> .
	Incorrect water softener setting.	See Water hardness in the chapter <i>Settings</i> .
	The water softener is leaking salt.	Check that the salt compartment lid is properly tightened. Otherwise contact your nearest service centre.
	Too high temperature and/or too much detergent can cause etching on crystal. Unfortunately, this cannot be repaired, only prevented.	Wash crystal at a low temperature and with a conservative amount of detergent. Contact the detergent manufacturer.
The dishes have a sticky white/blue film.	Rinse aid dosage setting too high.	Reduce the dosage. See the chapter <i>Settings</i> . If you have very soft water, you may want to dilute the rinse aid 50:50 with water.
Spots left after washing.	Lipstick and tea/coffee stains can be difficult to remove.	Use a detergent with a bleaching agent.
Detergent residue in the detergent compartment after dishwashing.	The detergent compartment was damp when adding detergent.	The detergent compartment must be dry when adding detergent.
	The detergent compartment has been blocked.	Check that the dishes are not preventing the detergent compartment from opening.
Rattling sound when dishwashing.	The dishes are not correctly placed or the spray arms are not rotating.	Check that the dishes are placed securely. Spin the spray arms to make sure they can rotate.

Troubleshooting

Problem	Possible causes	Action
Water remains in the dishwasher.	The filters are clogged.	Clean the coarse and fine filters.
	The filters are not fitted correctly.	Check that the filters are fitted correctly. See the chapter <i>Care and cleaning</i> .
	Debris in the drainage pump.	Clean the drainage pump. See the chapter <i>Care and cleaning</i> .
	Drainage pump stop missing.	Check that the yellow drainage pump stop (on the right in the bottom drain) is in place. See the chapter <i>Care and cleaning</i> .
	Kink in drainage hose.	Check that the hose is free from kinks and sharp bends.
	Blocked drainage hose.	Disconnect the drainage hose where it connects to the sink unit's water trap. Check that no debris has fastened and that the connection has an inner diameter of at least 14 mm.
Bad odour in dishwasher.	Dirt around the seals and in corners.	Clean with washing-up brush and low foaming cleaner.
	Low temperature programs have been selected for a prolonged period.	Run a program with a high temperature once or twice a month. Or run a self-cleaning program. See Self-cleaning in the chapter <i>Using the dishwasher</i> .
Grease deposits in the dishwasher.	Low temperature programs have been selected for a prolonged period.	Select a program with a high temperature to dissolve grease on very dirty dishes, such as Intensive. Or run a self-cleaning program once or twice a month. See Self-cleaning in the chapter <i>Using the dishwasher</i> .

Problem	Possible causes	Action
The dishes are not dry enough.	The Auto door open option is not activated.	Activate the Auto door open option.
	The dishwasher is not fully loaded.	Fully load the dishwasher.
	Rinse aid needs topping up or dosage is set too low.	Top up with rinse aid or increase the rinse aid dosage setting.
	The setting TAB is activated and all-in-one detergent with insufficient drying effect is being used.	Switch all-in-one detergents or deactivate the setting TAB and top up with salt and separate rinse aid. See Rinse aid in the chapter <i>Settings</i> .

Installation

It is important that you read through and follow the instructions and directions below. Conduct installation and connection in accordance with the separate installation instructions.

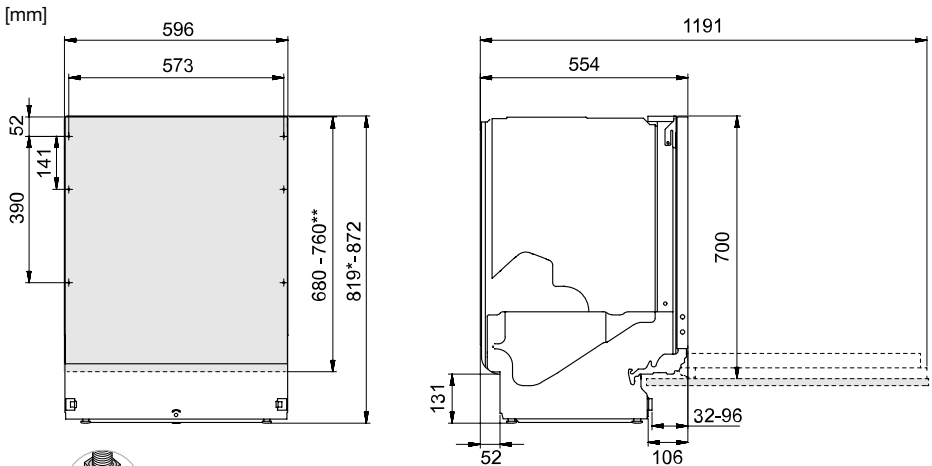

*Remove the locking nuts when installing in a recess measuring 820-821 mm.

**Cover door length.

Nominal dimensions. Actual measurements may vary.

Safety instructions

- Connections to electricity, water and drainage must be performed by a qualified professional.
- Always follow applicable regulations for water, drainage and electricity.
- Take care during installation! Wear protective gloves! There must always be two people!
- Place a drip tray on the floor beneath the dishwasher to prevent damage from any water leaks.
- Before screwing the dishwasher into place, test the dishwasher by running the Rinse and hold program. Check that the dishwasher fills with water and drains. Check also that none of the connections leak.

WARNING!

The ventilation opening in the lower part of the door must not be blocked by a rug, carpet or similar furnishing.

WARNING!

Turn off the water supply when installing the dishwasher!

The plug must be disconnected or power to the socket turned off while the work is carried out!

Setup

- The recess and connection dimensions are included in the separate installation instructions. Check that all dimensions are correct before starting the installation. Note that the height of the cover door can be adjusted to match other fittings.
- Make sure the area on which the dishwasher is to be installed is firm. Adjust the adjustable feet so that the dishwasher is level. Tighten the lock nuts.
- If the dishwasher is built-in the surrounding furnishings must be resistant to any condensation from the dishwasher.
- Mount the protective film beneath the worktop and up around the edge. The function of the protective film is to protect the worktop from moisture. (The protective film is in the enclosed plastic bag.)
- Check that the machine is installed such that the door opens freely, otherwise door lock functionality may be disrupted.
- Note that the door springs may need adjusting after a cover door has been fitted. Adjust the left and right door springs equally until the door is evenly balanced.

Drainage connection

This dishwasher is suitable for installing in a raised recess (to attain an ergonomic working height). This means that the dishwasher can be placed so that the drainage hose runs to a lower level than the bottom of the dishwasher, such as by routing it directly to a floor drain.

The drainage hose can also be connected to a connection nipple on the sink unit's water trap. The connection nipple must have an internal diameter of at least 14 mm.

The drainage hose may be extended by a maximum of 2.5 m (the total length of the drainage hose must not exceed 4.5 m). Any joints and connecting pipes must have an internal diameter of at least 14 mm.

No part of the drainage hose may be more than 950 mm above the bottom of the dishwasher.

Attach the drainage hose with a hose clamp. Ensure that the drainage hose has no kinks.

Connection to water supply

Use only the inlet hose supplied with the dishwasher. Do not re-use old or other spare hoses.

The supply pipe must be fitted with a water tap (stopcock). The water tap must be easily accessible, so that the water can be shut off if the dishwasher has to be moved.

Once the installation is complete, turn on the water tap and allow the pressure to settle for a while. Check that all connections are watertight.

Connect to cold water

Connect the dishwasher to the cold water supply if the building is heated using oil, electricity or gas.

Connect to hot water

Connect the dishwasher to the hot water supply (max. 70 °C) if the building is heated using an energy-efficient means such as district heating, solar power or geothermal power. Choosing a hot water connection reduces the dishwasher's energy consumption.

NOTE!

Do not exceed the permitted water supply temperature. Certain materials used in some cookware cannot withstand high heat. See *Fragile dishes* in the chapter *Loading the dishwasher*.

Installation

Electrical connection

Information about the electrical connection can be found on the serial number plate. This specification must match the electricity supply.

The dishwasher must be connected to an earthed socket.

The electric wall socket must be placed outside of the installation area to be easily accessible after installing the dishwasher. Do not use an extension cord!

Information about your product

There is a QR code on the serial number plate. Scan the code to view information about your product.

(only certain models)

Contact your nearest service centre

Read the chapter *Troubleshooting* before contacting the service centre. If you have encountered a problem that you cannot resolve, please contact your nearest service centre for professional help, see www.asko.com. Our website also has information about spare part availability and what you can repair yourself.

When making contact, provide the details on the serial number plate. Include the article number (1) and the serial number (2).

Please note that non-professional repairs may risk user safety and affect the warranty.



Number of cycles

Press and hold **PROG** and  for 3 seconds to show Number of cycles on the display.

Technical data and energy labelling

Technical data

Height:	819-872 mm
Width:	596 mm
Depth:	554 mm
Weight:	50 kg ¹⁾
Number of standard place settings:	14 ²⁾
Water pressure:	0.03-1.0 MPa
Electrical connection:	See the serial number plate
Rated power:	See the serial number plate

¹⁾ Weight can vary due to different specifications.

²⁾ In accordance with the EN 60436 standard.

Information for consumers

Information about your appliance can be found at <https://global.asko.com/energy-label>. You can also find information in the EU Product Registration database for Energy Labelling, EPREL. Scan the QR code on the energy label supplied with the dishwasher (or go to <https://eprel.ec.europa.eu> and search for the model name).

Information for test institute

Information about this product can be found in the European Product Database for Energy Labelling, EPREL, and can also be ordered by e-mail dishwashers@appliance-development.com.

The request should include the details on the serial number plate. Include the article number (1), the serial number (2) and the model name (3).

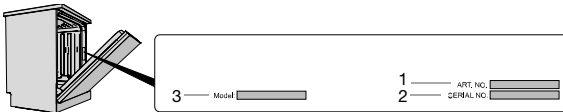

Declaration of conformity

We hereby declare that this appliance is in conformity with the relevant European directives and the requirements of the relevant standards.

ASKO

Inspired by Scandinavia

WWW.ASKO.COM



865212-a6

We reserve the right to make changes.