

Hisense

life reimagined

EN (GB) (IE)

**DETAILED INSTRUCTIONS
FOR USE OF UPRIGHT
REFRIGERATOR AND
FREEZER**



We thank you for the confidence you have shown by purchasing our appliance which is designed to simplify your life. To make the use of the product easier, we have supplied detailed instructions for use, and installation instructions supplied on a separate sheet. The instructions should allow you to learn about your new appliance as quickly as possible.

We wish you find a lot of pleasure in its use.

Link to the EU EPREL database

The QR code on the energy label supplied with the appliance provides a web link to the registration of this appliance in the EU EPREL database. Keep the energy label for reference together with the user manual and all other documents provided with this appliance. It is possible to find information related to the performance of the product in the EU EPREL database using the link <https://eprel.ec.europa.eu> and the model name and product number that you can find on the rating plate of the appliance. For more detailed information about the energy label, visit www.theenergylabel.eu.

The appliance is intended solely for household use.

The refrigerator is intended for storing fresh food at temperatures above 0°C.

The freezer is intended for freezing fresh food and for long-term storage of frozen food (up to one year, depending on the type of food).

The following symbols are used throughout the manual and they have the following meanings:

 **INFORMATION!**
Information, advice, tip, or recommendation

 **WARNING!**
Warning – general danger

 **ELECTRIC SHOCK!**
Warning – danger of electric shock

 **DANGER OF FIRE!**
Warning – danger of fire

Contents

Important notes and precautions	5
Before using the appliance for the first time	5
Important safety instructions	5
Important information on the use of appliance	8
Environment protection	10
Advice for saving power with refrigeration appliances	11
Installation and connection	12
Selecting the room	12
Appliance placement	12
Connecting the appliance	14
Reversing the door opening direction	15
Description of the appliance	18
Operating the appliance	19
Switching the appliance on/off	20
Adjusting the temperature in the appliance	20
Control unit/display standby mode	21
Intensive cooling (refrigerator compartment)	21
Intensive freezing (freezer compartment)	22
Eco function	22
Convert function	23
Wi-Fi function	23
Child Lock	28
High temperature alarm	28
Open door alarm	28
Power outage/power supply failure alarm	29
Appliance interior equipment	30
Shelf	30
Wire bottle rack *	30
Fruit and vegetable drawer with humidity control *	30
Chill Zone drawer *	30
Turning the Chill Zone drawer into a fruit and vegetables drawer *	31
Door racks	32
Multi Airflow	32
AdaptTech	32
Recommended distribution of food in the appliance	33
Storing food in the refrigerator	34
Important warnings regarding food storage	34
Avoid contamination of food	34
Freezing and storing frozen food	35
Freezing procedure	35
Important warnings on freezing	35
Storing industrially frozen food	35
Frozen food storage time	36
Thawing frozen food	36

Defrosting the appliance	37
Automatic refrigerator defrosting	37
Defrosting a NoFrost freezer	37
Manual defrosting of the NoFrost freezer	37
Cleaning the appliance	38
Troubleshooting	39
Information about appliance noise	41

Important notes and precautions

Before using the appliance for the first time

Before connecting the appliance to the power mains, please read carefully the instructions for use which describe the appliance and its correct and safe use. The instructions apply to several appliance types/models; thus, settings or equipment may be described herein which is not available in your appliance. We recommend saving this instruction manual for future reference and attach it to the appliance if it is sold in the future.

The instruction manual includes the No Frost version/model of the freezer which is fitted with a fan and in which the defrosting process is automatic (only with some models).

Check for any damage or irregularities on your appliance. If you find your appliance is damaged, notify the retailer from which you have purchased the appliance.

Before connecting the appliance to the power mains, let the appliance rest in a vertical position for a minimum of 2 hours. This will reduce the possibility of operation faults due to the effect of transport on the cooling system.

Important safety instructions



 **DANGER OF FIRE!**
WARNING! Risk of fire/flammable materials.

The appliance must be connected to the power mains and grounded in compliance with the effective standards and regulations.

WARNING! Do not locate multiple portable socket-outlets or portable power supplies at the rear of the appliance.

Before cleaning the appliance, unplug it from the power mains (unplug the power cord from the wall outlet).

 **ELECTRIC SHOCK!**

WARNING! If the supply cord is damaged, it must be replaced by the manufacturer, its service agent or similarly qualified persons in order to avoid a hazard.

 **ELECTRIC SHOCK!**

WARNING! When positioning the appliance, ensure the supply cord is not trapped or damaged.

 **ELECTRIC SHOCK!**

If LED lighting does not work, call a service technician. Do not attempt a repair of the LED lighting yourself, as there is danger of contact with high voltage!

 **WARNING!**

WARNING! Do not use electrical appliances inside the food storage compartments of the appliance, unless they are of the type recommended by the manufacturer.

 **WARNING!**

WARNING! Do not use mechanical devices or other means to accelerate the defrosting process, other than those recommended by the manufacturer.

 **WARNING!**

WARNING! To avoid any hazard resulting from poor stability of the appliance, make sure it is installed as instructed.

Freeze burn hazard

To avoid freeze burn, never put frozen food in your mouth and do not touch frozen food.

Safety of children and vulnerable persons

The appliance is not intended for use by persons (including children) with reduced physical, sensory or mental capabilities, or lack of experience and knowledge, unless they have been given supervision or instruction concerning use of the appliance by a person responsible for their safety.

Children should be supervised to ensure that they do not play with the appliance.

Cleaning and user maintenance shall not be made by children without supervision.

Remove the packaging intended to protect the appliance or particular parts during transport and keep it outside the reach of children. It presents danger of injury or suffocation.

When removing a used appliance, disconnect the power cord, remove the door, and leave the shelves in the appliance. This will prevent children from locking themselves in the appliance.

For European markets only

This appliance can be used by children aged from 8 years and above and persons with reduced physical, sensory or mental capabilities or lack of experience and knowledge if they have been given supervision or instruction concerning use of the appliance in a safe way and understand the hazards involved.

Children shall not play with the appliance.

Cleaning and user maintenance shall not be made by children without supervision.

Children aged from 3 to 8 years are allowed to load and unload refrigerating appliances.

Warning regarding the refrigerant

The appliance contains a small amount of an environmentally friendly yet flammable gas R600a. Make sure that no parts of the cooling system are damaged. A gas leak is not hazardous to the environment, but it could cause eye injury or fire.

In case of a gas leak, ventilate the room thoroughly, disconnect the appliance from the power mains, and call a service technician.

Important information on the use of appliance



WARNING! This appliance is intended to be used in household and similar applications such as:

- staff kitchen areas in shops, offices and other working environments;
- farm houses and by clients in hotels, motels and other residential type environments;
- bed and breakfast type environments;
- catering and similar non-retail applications.

⚠ WARNING!

WARNING! Keep ventilation openings, in the appliance enclosure or in the built-in structure, clear of obstruction.

The appliance may not be used outdoors and it may not be exposed to rain.

Do not store explosive substances such as aerosol cans with a flammable propellant in this appliance.

If the appliance will be out of use for an extended period of time, switch it off using the relevant button, and unplug it from the power mains. Empty the appliance, defrost it, clean it, and leave the door ajar.

In case of an error or power supply failure, do not open the freezer compartment unless the freezer has not operated for over 16 hours. After this period, use the frozen food or provide sufficient cooling (e.g. a replacement appliance).

Technical information on the appliance

Rating plate can be found in the appliance interior. It indicates data on voltage, gross and net volume, type and amount of refrigerant, and information on the climate classes.

If the language on the rating plate is not the language of your choice or the language of your country, replace it with the one supplied.

⚠ WARNING!

WARNING! Do not damage the refrigerant circuit. This will also prevent pollution.

Environment protection

Packaging is made of environmentally friendly materials that can be recycled, disposed of, or destroyed without any hazard to the environment.

Removing an obsolete appliance

To protect the environment, take the obsolete appliance to an authorized home appliance collection centre.

Before doing so, do the following:

- disconnect the appliance from the power mains;
- do not allow children to play with the appliance.



■ The symbol on the product or its packaging indicates that the product should not be treated as normal household waste. The product should be taken to an authorized collection centre for waste electric and electronic equipment processing. Correct disposal of the product will help prevent any negative effects on the environment and health of people which could occur in case of incorrect product removal. For detailed information on removal and processing of the product, please contact the relevant municipal body in charge of waste management, your waste disposal service, or the store where you bought the product.

Advice for saving power with refrigeration appliances

- Install the appliance as specified in the instruction manual.
- Do not open the door more often than necessary.
- Occasionally make sure air circulation underneath the appliance is unobstructed.
- If the gasket is damaged or does not provide a perfect seal for any reason, have it replaced as soon as possible.
- Store the food in tightly sealed containers or appropriate packaging.
- Before placing the food in the refrigerator, allow it to cool down to room temperature.
- Defrost frozen food in the refrigerator compartment.
- To make use of the entire freezer compartment interior volume, remove some of the drawers as described in the instruction manual.
- Make sure the layout of shelves in the compartment is uniform and that the food is placed so that the air can freely circulate in the appliance interior (observe the recommended placement of food as described in the instructions).

Installation and connection

Selecting the room

- Install the appliance in a dry and well ventilated room. The appliance will operate correctly if the environment temperature is in the interval specified in the table. The appliance class is indicated on the rating plate / label with the basic information on the appliance.

Description	Class	Ambient temperature range °C	Relative humidity
Extended temperate	SN	+10 to +32	≤75%
Temperate	N	+16 to +32	
Subtropical	ST	+16 to +38	
Tropical	T	+16 to +43	



INFORMATION!

This appliance is not intended to be used as a build-in appliance.



INFORMATION!

Do not place an appliance in a room where temperature can drop to below 5 °C as this may cause abnormal appliance operation or failure!

- After the installation, the appliance mains plug should be accessible!
- Do not place the appliance near appliances or devices radiating heat, such as a cooker, a stove, a radiator, water heater etc., and do not expose it to direct sunlight. The appliance should stand at least 3 cm away from an electric or gas cooker or at least 30 cm away from an oil or solid fuel stove. If the distance between such source of heat and the appliance is smaller, use an insulating panel.

Note: Place the appliance in a sufficiently large room. There should be at least 1 m³ of space per 8 grams of refrigerant. Amount of refrigerant is indicated on the rating plate in the appliance interior.

Appliance placement

Appliance installation should be carried out by at least two persons to avoid any personal injury or damage to the appliance.

- The appliance must stand level or tilted slightly to the back. It should be stable and placed on a solid base. At the front, the appliance is fitted with two adjustable feet that can be used to level the appliance. At the rear side, casters allow for easier installation of the appliance (only with some models).



- After you have levelled the appliance using the adjustable feet, adjust the additional foot for extra stability of the appliance.
- Do not expose the appliance to direct sunlight and do not place it near sources of heat. If this cannot be avoided, install an insulation panel.

- The appliance is intended for free-standing installation. To reach the rated/minimum power consumption, always provide 50 mm of clearance between the wall and the back of the appliance, and above the appliance. Also allow adequate air circulation on either side of the appliance and above it.
- The appliance can also be placed adjacent to or between kitchen cabinets or cupboards, or adjacent to a wall. In case of such placement, the appliance will operate flawlessly; however, power consumption could increase. Observe the minimum clearance above and behind the appliance, as indicated in the figure.
- Take into account the space or clearance required to open the appliance door, in order to allow the drawers and shelves to be pulled out or removed (see installation diagram).

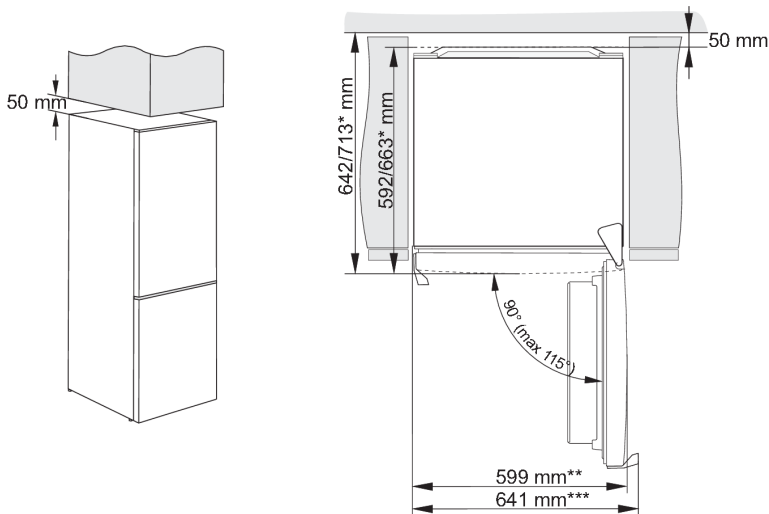

* depending on the model

** model with integrated handle

*** model with external/protruding handle

Connecting the appliance

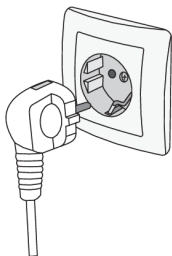





- Connect the appliance to the power mains using the power cord. The wall outlet should be fitted with a ground contact (safety socket). Nominal voltage and frequency are indicated on the rating plate/label with basic information on the appliance.
- The appliance must be connected to the power mains and grounded in compliance with the effective standards and regulations. The appliance will withstand short-term deviations from the nominal voltage, but not more than +/- 6%.

Reversing the door opening direction

The direction in which the appliance door opens can be reversed.

Note: Disconnect the appliance from the power mains before reversing the door opening direction.

Tools required:	
	Socket wrench No. 8,
	Cross-point screwdriver
	Flat screwdriver
	Spanner No. 8

Note:

- If the appliance has to be tilted to allow access to parts on the bottom, ask another person for assistance or gently place the appliance on some soft padding to prevent damaging it. To reverse the opening direction, proceed as follows.

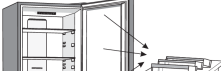
1.  Place the appliance in an upright position. Open the top door and remove the door racks (to prevent damaging them during the procedure). Close the door.

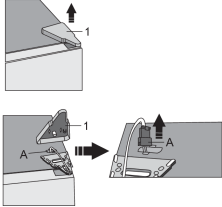
2.  Remove the top hinge cap (1). Be particularly careful not to damage the connector (A). Unplug the connector (A).

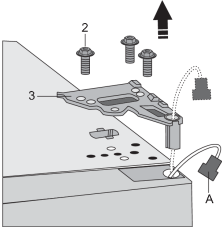
3.  Undo the screws (2) and remove the hinge (3). Run the connector (A) through the hole in the hinge. Hold the door while doing this to prevent it from falling.

4.

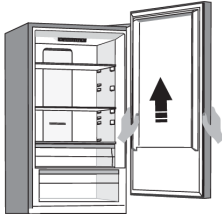

Remove the top door from the middle hinge by carefully lifting it straight up. Lay the door onto a smooth surface.

5.

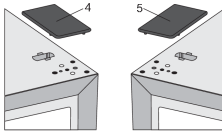

Take the (right) cap/cover (4) from the bag and place it on the spot from which the top hinge was removed. Remove and save the cap/cover from the other side (5) to which the hinge will be relocated.

6.

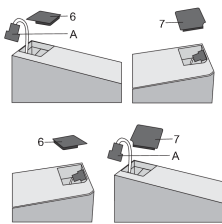

Remove the cap (6) from the left side of the top door and pull out the connector (A). Then, remove the cap (7) from the right side of the top door. Place the cap (7) on the left side of the top door and place the cap (6) on the right side of the top door.

7.

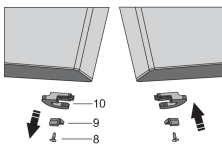

Undo the screw (8) and remove the door retainer (10) and the door stop (9). Then, use a screw (8) to install the door retainer supplied in the bag, and the door stop (9). Keep the door retainer (10) in case you need it later.

8.

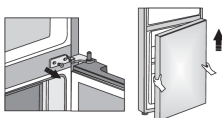

Undo the screws from the middle hinge and remove it. Then, remove the bottom door from the bottom hinge.

9.

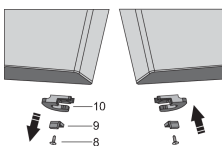

Lay the bottom door onto a smooth surface. Undo the screw (8) and remove the door retainer (10) and the door stop (9). Then, use a screw (8) to attach the door retainer supplied in the bag, and the door stop (9). Keep the door retainer (10) in case you need it later.

10.

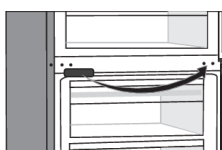

Remove the middle hinge cap and replace it on the opposite side.

11. Tilt the appliance backwards and remove the adjustable foot (11).

12.

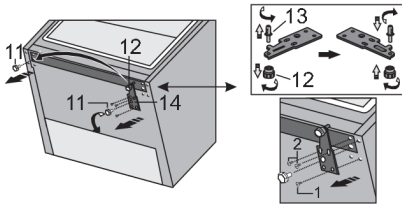

Undo the three screws on the bottom hinge (14) and remove it. Remove the extra foot (12) from the bottom hinge pin (13). Unscrew the pin (13) from the bottom hinge and screw it onto the opposite side of the hinge, complete with the extra foot (12).

13.

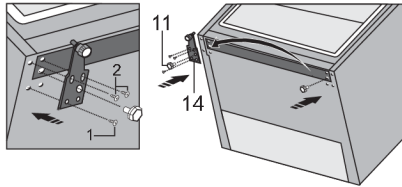

Attach the hinge (14) onto the opposite side using the screws. The screws should be attached in the order shown in the figure below. First, tighten the screw 1, followed by screws 2. Then, screw on the adjustable feet (11).

14.

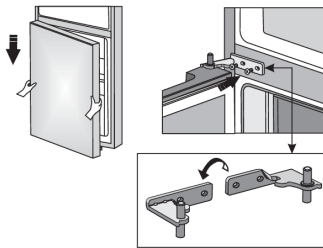

Place the bottom door onto the bottom hinge and hold them in place. Rotate the middle hinge by 180°. Place the washer in the correct position and adjust the position of the middle hinge so that you can install and fix the bottom door.

15.

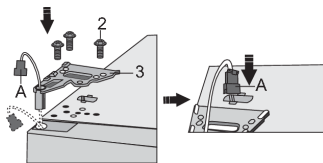

Correctly position the top door, run the connector (A) through the hole in the top hinge (3) and use the screws (2) to attach it. Hold the top door in place while positioning them. Reconnect the connector (A).

16.

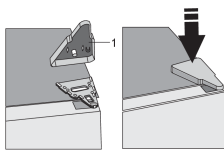

Replace the upper hinge cap (1).

17. Open the top door and replace the door rack; then, close the door.



Note: If your model has a handle, then move it to the opposite side by following the instructions below.

Remove the caps (1) and undo the two screws (2) as shown in the figure. Rotate the handle (3) by 180° and replace it on the opposite side. Then, fasten the screws (2) and replace the caps (1).

Description of the appliance

Appliance interior equipment may change according to the appliance model.

This product contains a light source of energy efficiency class G.

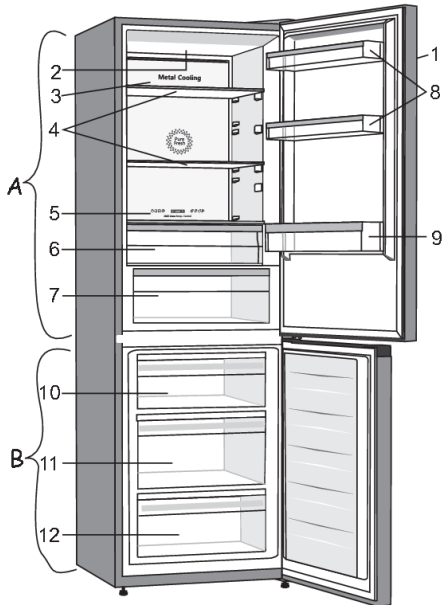

A Refrigerator

1. Control panel
2. LED lighting
3. Multi Airflow column
4. Glass shelves
5. Slider for converting the Chill Zone drawer into a fruit and vegetables bin
6. Chill Zone drawer
7. Fruit and vegetable drawer with humidity control *
8. Low door racks
9. Bottle shelf

B Freezer

10. Top freezing and storage drawer
11. Deep SpaceBox drawer for freezing and storage
12. Bottom storage drawer

- The drawers are fitted with a system that prevents them from being unintentionally pulled out. To remove a drawer from the appliance, pull it out as far as it will go, then lift at the front and pull out completely.

* Only in some models

Operating the appliance

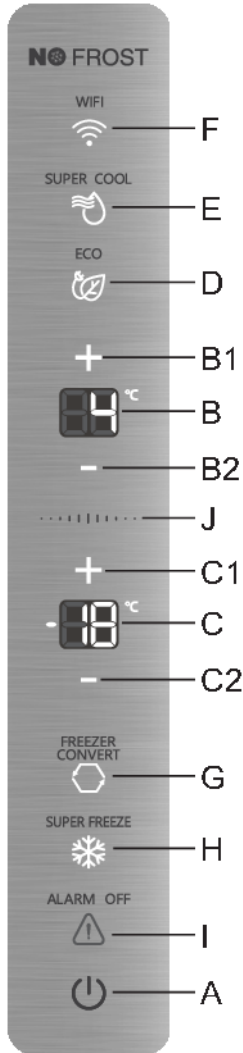

- A** Appliance on/off key
- B** Refrigerator compartment temperature display
- B1** Refrigerator compartment temperature increase key
- B2** Refrigerator compartment temperature decrease key
- C** Freezer compartment set temperature display
- C1** Freezer compartment temperature increase key
- C2** Freezer compartment temperature decrease key
- D** Eco function on/off key
- E** Intensive cooling (super cool) on/off key
- F** Wi-Fi function
- G** Freezer/ZeroZone convert key
- H** Intensive freezing (fast freeze) on/off key
- I** Acoustic alarm off key
- J** Standby wake-up key

Switching the appliance on/off

When you connect the appliance to the power mains for the first time, the appliance will be in standby mode (switched off, but powered).

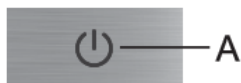

Switching on the appliance: to switch on the appliance, press the **A** key. A beep will be sounded and temperature display will appear on the display units **B** and **C**.

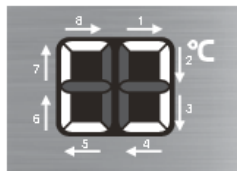

Switching off the appliance: to switch off the appliance, press the **A** key and hold it for a while (2 seconds). A beep will be sounded again and the outer segments of the display digits **B** will light up in the clockwise succession. The appliance is in standby mode (it is still powered).

Adjusting the temperature in the appliance

INFORMATION!

- Appliance temperature is preset at the factory to the recommended setting, i.e. 4°C for the refrigerator compartment and -18°C for the freezer compartment.
- After the appliance is switched on, it may take several hours until the set temperature is reached. Do not place any food into the appliance before the temperature drops to the selected setting.

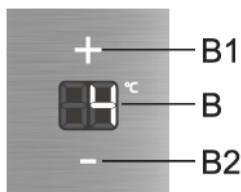

Use the **B1** and **B2** keys to set the temperature in the **refrigerator compartment**.

- + Increase temperature
- Decrease temperature

- Refrigerator compartment temperature can be set in the range from +1°C to 9°C.
- Each time you press either **B1** or **B2**, the temperature is increased or decreased by 1 °C. Three seconds after the most recent key is pressed, the current setting is automatically stored as the most recent temperature setting for the refrigerator compartment of the appliance.
- Recommended temperature setting is 4°C.

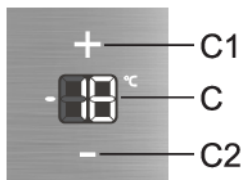

Use the **C1** and **C2** keys to set the temperature in the **freezer compartment**.

- + Increase temperature
- Decrease temperature

- Freezer compartment temperature can be set in the range from -16°C to -24°C.
- Each time you press either **C1** or **C2**, the temperature is increased or decreased by 1°C. Three seconds after the most recent key is pressed, the current setting is automatically stored as the most recent temperature setting for the freezer compartment of the appliance.
- Recommended temperature setting is -18°C.

Control unit/display standby mode



INFORMATION!

30 seconds after the most recent key is pressed, the control unit/display switches to standby mode. All indicators and displays on the control unit will be switched off. If any of the extra functions is activated, its indicator will remain lit while the appliance is in standby mode, too.

To switch back from the standby mode: briefly press the **A** or **J** key or open the refrigerator compartment door. If any of the extra functions are activated, you may also press the key for activating or deactivating that extra function in order to wake up the appliance from the standby mode.

Intensive cooling (refrigerator compartment)



INFORMATION!

Use this setting after switching on the appliance for the first time, before cleaning, or before inserting a large amount of food.

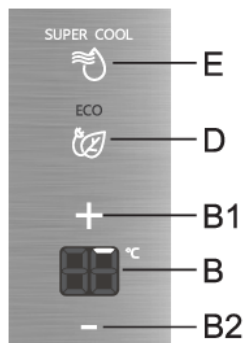

To activate: to activate the intensive cooling (super cool) function, press the **E** key. A beep will be sounded and the **SUPER COOL** indicator will light up.

Outer segments of the digit on the **B** display unit will light up in succession. At first, only the first segment will be lit (see figure above); then, successive segments will light up in the clockwise direction.



Towards the end of this function's operation, all outer segments on the **B** display unit will be lit up.

- While the intensive cooling (super cool) function is activated, freezer compartment temperature can be set or adjusted as usual.
- To change the refrigerator compartment temperature while the intensive cooling (super cool) function is activated, however, the intensive cooling function has to be deactivated first by pressing the **E** key.

To deactivate: to deactivate the intensive cooling (super cool) function, press the **E** key. You will hear a beep and the **SUPER COOL** indicator will no longer be lit. If the function is not deactivated manually, it will be deactivated automatically after approximately twelve hours.

INFORMATION!

When the intensive cooling (super cool) function is activated, the appliance will operate with maximum power. During this time, operation may be temporarily somewhat louder.

Intensive freezing (freezer compartment)

INFORMATION!

Use this setting after switching on the appliance for the first time, before cleaning, or before inserting a large amount of food.

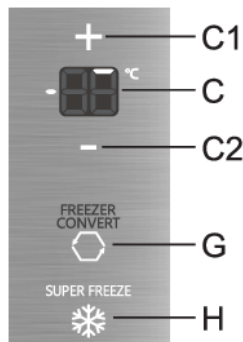

To activate: to activate the intensive freezing (fast freeze) function, press the **H** key. You will hear a beep and the **SUPER FREEZE** indicator will light up.

Extreme freezing (upper drawer of the freezer compartment): This feature only works in the upper drawer of the freezer compartment. It relies on intensive supply/blowing of cool air. Faster freezing will retain more vitamins, minerals, and nutrients in the food for a longer period of time.

Outer segments of the digit on the **C** display unit will light up in succession. At first, only the first segment will be lit (see figure above); then, successive segments will light up in the clockwise direction.



Towards the end of this function's operation, all outer segments on the **C** display unit will be lit up.

- While the intensive freezing (fast freeze) function is activated, refrigerator compartment temperature can be set or adjusted as usual.
- To change the freezer compartment temperature while the intensive freezing (fast freeze) function is activated, however, the intensive freezing (fast freeze) function has to be deactivated first by pressing the **H** key.

To deactivate: to deactivate the intensive freezing (fast freeze) function, press the **H** key. You will hear a beep and the **SUPER FREEZE** indicator will no longer be lit. If the function is not deactivated manually, it will be deactivated automatically after approximately two days.

INFORMATION!

When the intensive freezing (fast freeze) function is activated, the appliance will operate with maximum power. During this time, operation may be temporarily somewhat louder.

Eco function



To activate: to activate the **eco** function, briefly press the **D** key. The **ECO** indicator will light up. When this function is activated, the appliance operates under optimum settings.

To deactivate: to deactivate the **eco** function, again briefly press the **D** key. The temperature will return to the most recent setting.

The **eco** function will also be deactivated when you use the **B1** key to change the refrigerator compartment temperature setting, or when you activate any of the other extra functions.

Convert function

The entire freezer compartment can be converted into a **Chill Zone** compartment. The temperature in this compartment is at or slightly below 0 °C. Therefore, do not store food that is sensitive to low temperature in this compartment, as such food could freeze. Before switching to **Chill Zone** function, empty the freezer compartment to prevent the frozen food from defrosting and perishing.

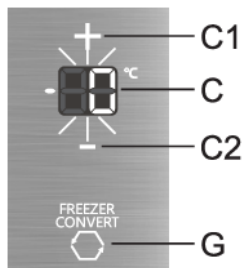

- **Activating the Convert function:** press the **G** key. A beep will be sounded, and the **FREEZER CONVERT** indicator will light up.
- When this function is activated, the temperature in the freezer compartment will be set to 0°C, while the refrigerator compartment temperature will be set to 4°C. "0°C" will flash on the **C** display until the temperature in the freezer compartment reaches the appropriate temperature. When this temperature is reached, the "0°C" indicator will be constantly lit.

- **Setting the temperature in the Chill Zone compartment:** use the **C1** or **C2** keys to set the temperature between -2°C and +3°C.
- The temperatures are approximate and they depend on the temperature settings in the refrigerator compartment, environment temperature, frequency of door opening, and amount of food inserted. Setting a high temperature in the **Chill Zone** compartment will also increase the temperature in the refrigerator compartment, and vice versa. Adjust the setting to the operating conditions.
- If the bottom compartment functions as a **Chill Zone**, the temperatures in the refrigerator compartment can only be set in the range from 4°C to +8°C. We recommend such use only when environment temperature is between +16°C and +32°C. At higher temperatures, it is not possible to guarantee adequately low temperatures in the appliance.
- When the **Convert** function is activated, any other extra functions will be deactivated.
- **Deactivating the Convert function:** press the **G** key again. A beep will be sounded, and the **FREEZER CONVERT** indicator will no longer be lit.

INFORMATION!

The **Convert** function also affects the temperatures in the **Chill Zone** drawer. When this function is activated, the temperature in the drawer will not be close to 0°C. Rather, the drawer will function as a **fruit and vegetables bin** regardless of the slider setting or position, which may lead to food spoilage. Therefore, we recommend moving food sensitive to higher temperatures to a more suitable place.

Wi-Fi function

This appliance may be controlled remotely with a smart phone or a tablet computer. If the appliance is not connected to the home network, it will function like a regular appliance.

What do you need to connect the appliance?

- Signal from the local wireless network (Wi-Fi) should be sufficiently strong in the spot where the appliance is installed.
- Home network router has to be connected to the internet, and the Wi-Fi function on the appliance should be activated.
- The smart phone/tablet computer has to be connected to the internet.
- Operating system on your smart phone/tablet computer should be compatible with the ConnectLife app.

Installing the ConnectLife app

1. Go to the App Store (on Apple devices), AppGallery (on Huawei Android devices) or Google Play store (on Android devices) on your phone/tablet computer.
2. Search for "ConnectLife"  .
3. Choose the ConnectLife app and install it on your smart phone/tablet computer.

INFORMATION!

We recommend downloading and installing the mobile app and creating a ConnectLife account before attempting to set up the connection with your appliance.

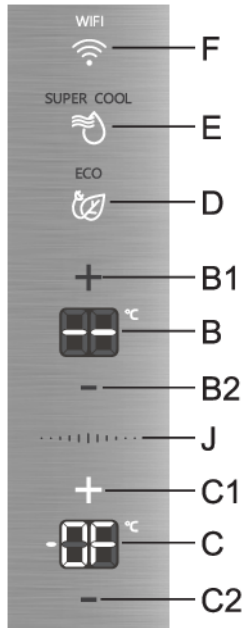

Opening the Wi-Fi menu



Press the **F** key. A beep will be sounded and the **F** indicator will light up.

All other indicators, or symbols, will be turned off. Only the **C1** key and the **C** display unit will remain active. -- will appear on the **B** display unit.

At this point, you can use the **C1** and **C2** keys to switch between two options:

	Display	Setting description
1		Wi-Fi disabled
2		Wi-Fi enabled

Press the **C1** key to switch **On** the display unit **C**. If Wi-Fi is disabled, the **J** key will light up. Press the **J** key to turn on Wi-Fi.

Press the **C2** key to switch **Off** the display unit **C**. If Wi-Fi is enabled, the **J** key will light up. Press the **J** key to turn off Wi-Fi.

When Wi-Fi is enabled, you can continue the connecting process.



INFORMATION!

Use the **B1** and **B2** keys to switch between the available options **CS**, **P**, **U**, and **C**.

Connecting (CS)

After activating the Wi-Fi function, connect your device to your home router in order to connect your appliance with the ConnectLife mobile app.

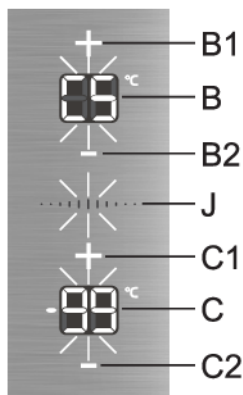

1. When **CS** is displayed on the **B** display unit, briefly press the **J** key. The **CS** indicator and the **J** key start to flash. Time will start counting down from 99 to 0 on the **C** display unit, indicating function progress. After 5 minutes, it will terminate automatically.
2. Use the **ConnectLife** app to add your appliance and connect it to the app.

- The function will be deactivated automatically once you are successfully connected to the cloud. **P** will appear on the display unit **B**. Now you can continue to pair your appliance with your mobile devices.

Pairing (P)

The appliance can be paired with your mobile device. Remote appliance control is automatically activated (see chapter "Remote control (C)").

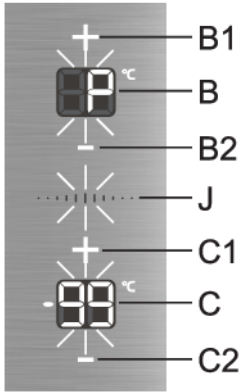

1. When **P** is displayed on the **B** display unit, briefly press the **J** key. The **P** indicator and the **J** key start to flash. Time will start counting down from 99 to 0 on the **C** display unit, indicating function progress. After 3 minutes, it will terminate automatically.
2. Open the **ConnectLife** app and pair the appliance with the app account.

- The function will terminate automatically after successful pairing with the app account. **C** indicator will be displayed on the **B** display unit.
- The function will also terminate automatically after 3 minutes if pairing was not successful.
- You can also terminate the function by briefly pressing the **J** key; however, this will cancel the pairing process.



INFORMATION!

If the appliance has already been connected to the internet and paired with a mobile device, and you wish to add another mobile device, then start the process at the pairing step (P).

Cancelling all pairings (U)

By activating this function, the appliance will be removed from all paired app user accounts.

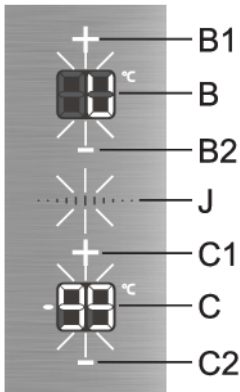

- When **U** is displayed on the **B** display unit, briefly press the **J** key. The **U** indicator and the **J** key start to flash. Time will start counting down from 99 to 0 on the **C** display unit, indicating function progress. After 1 minute, it will terminate automatically.
- The function will terminate automatically after successful removal of all pairings in the cloud. **P** indicator will be displayed on the **B** display unit.
- After 1 minute, the function will be automatically terminated even if all pairings in the cloud have not been successfully removed.
- The function may also be terminated manually by pressing the **J** key. This will stop the process of removing all pairings.

Remote control (C)

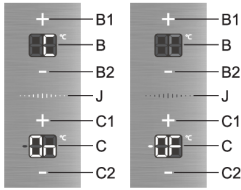

The remote control (C) function status is indicated on display unit **C**.

Disabling remote control: If remote control is **enabled**, then **On** will be displayed on the display unit **C**. Press the **C2** key to switch **Off** the display unit **C**. If remote control is enabled, the **J** key will light up. Press the **J** key to **turn off** remote control.

Enabling remote control: If remote control is **disabled**, then **Off** will be displayed on the display unit **C**. Press the **C1** key to switch **On** the display unit **C**. If remote control is disabled, then the **J** key will light up. Press the **J** key to turn on remote control.

You can now use your smart phone/tablet computer to remotely control your appliance via the app.

Wi-Fi indicator statuses

The Wi-Fi indicator can have several statuses:

Wi-Fi function	Connection to the cloud	Remote control	Wi-Fi icon	Description
Turned off	/	/		F symbol is not lit
Turned on	Not connected	/		Symbol F flashes: 1 second lit / 1 second off
Turned on	Connected	Disabled		Symbol F flashes: 0.5 second lit / 0.5 second off
Turned on	Connected	Enabled		F symbol is lit

Closing the Wi-Fi menu



To close the Wi-Fi menu, long-press the **F** key. Set temperature will appear on display units **B** and **C**.

Wi-Fi menu will close automatically after 5 minutes of display inactivity.

INFORMATION!

If a special function was active before you opened the Wi-Fi menu, then this function will continue to be active once you exit the Wi-Fi menu.

INFORMATION!

If any of the alarms is activated or a fault or error is detected, it will not be displayed while the Wi-Fi menu is open; rather, it will only be displayed once the Wi-Fi menu is closed.

Child Lock

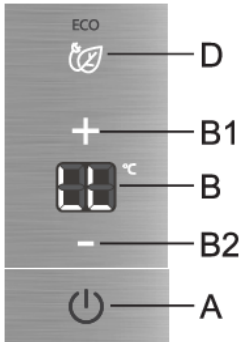

To activate: to activate the child lock, simultaneously press and hold (for 2 seconds) the **A** and **D** key. A beep will be sounded, and **LL** will briefly appear on the **B** display.

The function will lock all keys except the **A**, **D**, **I** and **J** key.

Switching off: To deactivate the function, press and hold the **A** and **D** keys again.

In case of a power supply failure or outage, the function will be reactivated.

High temperature alarm

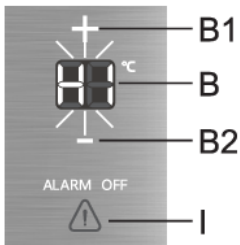

If the temperature inside the appliance is too high, an acoustic alarm will be activated (intermittent tone), and **HI** will flash on the **B** or **C** display unit, depending on the appliance compartment in which the temperature is too high.

- Every time the appliance is switched on with the **A** key, there is a 24-hour delay in high temperature alarm operation. If the appliance does not reach the sufficiently low temperature in this period, the alarm will be activated.

Switching off the alarm:

- to acknowledge and switch off the acoustic alarm, press the **I** key. When the **I** key is pressed the first time, the alarm will be switched off and the highest temperature registered in the relevant compartment will be indicated on the **B** or **C** display unit. When the **I** key is pressed the second time, the currently set temperature will flash on the **B** or **C** display unit. The temperature indication will continue to flash until the actual temperature in the appliance drops below the alarm level.
- When the appliance reaches an adequate temperature, then the temperature display will stop flashing and it will be lit continuously.
- If you do not acknowledge and switch off the acoustic alarm, then it will be activated every hour for approximately 15 minutes.

Open door alarm

If the refrigerator or freezer compartment door is open for too long, an acoustic alarm (repetitive beep) will be activated. If the alarm is not switched off manually, it will be sounded for 10 minutes. The appliance will continue to operate as if the door was closed.

To switch off the alarm: to switch off the alarm, close the appliance door.



INFORMATION!

If you switch off the alarm by pressing the **I** key, it will be activated again after 4 minutes if the door is still open.



INFORMATION!

If you leave the door open for more than 10 minutes, the alarm will no longer be sounded. Appliance operation will switch to safe mode in order to provide sufficient cooling and prevent food spoilage despite the open door.

Power outage/power supply failure alarm

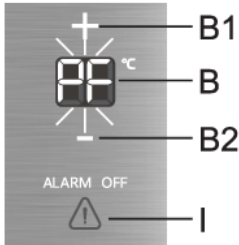

If the temperature in the appliance increased to alarm level during a power outage (power supply failure), then the high temperature alarm will be activated when power supply is restored. Acoustic alarm will be activated, and **PF** will flash on the **B** or **C** display unit, depending on the appliance compartment in which the temperature is too high.

To acknowledge and switch off the alarm, press the **I** key. The highest registered temperature will be indicated on the **B** or **C** display unit.

When you press the **I** key again, the power outage (power supply failure) alarm will be finally deactivated and the set temperature will appear on the **B** or **C** display unit.

If the high temperature alarm is activated at the same time, it will operate as described in the chapter High temperature alarm, after you have deactivated the power supply failure alarm.

Appliance interior equipment

(* Equipment depends on the model)

Shelf

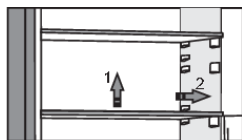

You can lay out the empty shelves to your liking across the guides in the refrigerator interior without having to remove them from the refrigerator. To move the shelf or take it out from the refrigerator, slightly lift it at the back, pull it towards you, and then either move it or take it out of the appliance. Store quickly perishable food at the back of the shelf where the temperature is the lowest.

Wire bottle rack *

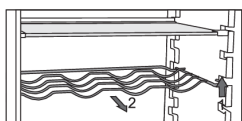

- Some models also feature a wire bottle holder. It is protected against being inadvertently pulled out. It can only be pulled out when it is empty. To pull it out, lift it slightly at the front and pull it towards you. Place the bottle holder so that the length of the bottles does not prevent proper closing of the door. The holder can take a maximum load of nine 0.75-litre bottles or 13 kilograms of total weight – see label on the right side in the appliance interior.
- Cans may also be placed on the bottle rack (lengthwise or crosswise).

Fruit and vegetable drawer with humidity control *

- The drawer at the bottom of the refrigerator is intended for storing fruit and vegetables. It provides humidity and prevents the food from drying out.
- The humidity in the drawer is regulated automatically, depending on the type and amount of inserted food.

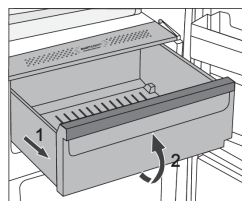

- Pulling out the bin:
 - Pull out the bin as far as it will go. Then, lift the front part and pull it out completely.

Chill Zone drawer *

(Only in some models)

The **Chill Zone** compartment allows storing a wide variety of fresh food for up to three times longer than in a conventional refrigerator. The food stays fresh longer, retaining the flavour and nutrients. The temperature in this drawer depends on the temperature settings in the refrigerator compartment, environment temperature, frequency of door opening, and amount of food placed in it.

For a temperature around 0 °C in the **Chill Zone** drawer, we recommend setting the refrigerator compartment temperature to 4 °C or lower. Temperature in the **Chill Zone** drawer may fall below 0 °C. Therefore, place the temperature-sensitive food in the upper parts of the refrigerator.

For optimum performance, the drawer should be fully closed.

- When buying food, make sure it is fresh as this will determine the quality of the food, as well as how long it will keep in the fridge.
- Store the food in closed containers or appropriate packaging to prevent them from emitting or receiving odours and humidity.
- Take the food from the drawer 30 to 60 minutes before use to allow the aroma and flavour develop at room temperature.
- Food sensitive to low temperature and not appropriate for storage in the **Chill Zone** drawer include the following: pineapple, avocado, bananas, olives, potatoes, eggplant, cucumbers, beans, peppers (capsicum), melons, watermelons, pumpkins, squash, zucchini etc.

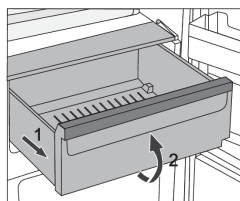

- To remove the drawer:
 - Pull out the drawer until it is blocked.
 - Lift it at the front and pull out completely.

Turning the Chill Zone drawer into a fruit and vegetables drawer *

- If you find you need extra space for your fruit and vegetables, you can turn your **Chill Zone** drawer into a fruit and vegetables drawer.



- To do this, use the slider as follows:
 - To use the drawer as a **Chill Zone**: push the slider to the right.
 - To use the drawer as a **fruit and vegetables drawer**: move the slider to the left.

INFORMATION!

When the **Convert** function is activated, the drawer will function as a **fruit and vegetable bin** regardless of the slider setting or position. Even if the slider is set to **Chill Zone** position, the temperature in the drawer will not be close to 0 °C, which may lead to food spoilage. Therefore, we recommend moving food sensitive to higher temperatures to a more suitable place.

Door racks

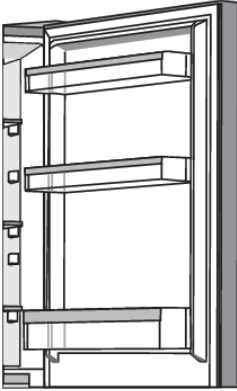

Interior side of the refrigerator door is fitted with shelves intended for storing cheese, butter, eggs, yoghurt, and other smaller packages, tubes, cans etc.

You may lay out the racks as desired by lifting them slightly from the grooves that hold them in place and moving them to the desired spot, making sure to fit them in the grooves there.

The bottom rack is intended for storing bottles.

Maximum load on each door shelf is 5 kg.

Multi Airflow

- The advanced **Multi Airflow** fan system evenly distributes the temperature throughout the entire refrigerator. Air mimics the natural microclimate that keeps the food fresh for longer. This system also allows placing any type of food on any shelf in the fridge, as there are not temperature differences between them.

AdaptTech

Innovative sensor technology allows adjusting appliance operation to the user's habits or behaviour. Adaptive intelligent system monitors, analyzes, and records on a daily and weekly basis the use of appliance and adapts appliance operation to the perceived patterns. If the appliance is able to anticipate increased frequency of door opening, the appliance will automatically lower the temperature before such time to prevent the increase of food temperature as the door is opened more often. The appliance will also anticipate adding larger amounts of food into the refrigerator or freezer and adapt by cooling or freezing more intensively.

Recommended distribution of food in the appliance

Sections in the refrigerator compartment:

- upper part: canned food, bread, wine, pastry etc.
- middle part: dairy products, ready-made meals, desserts, soft drinks, beer, cooked food, etc.
- Chill Zone bin: meat, meat produce, delicatessen;
- Fruit and vegetable bin: fresh fruit, vegetables, salads, root vegetables, potatoes, onions, garlic, tomatoes, sauerkraut, turnips etc.



Sections in the refrigerator compartment door:

- upper/middle door bins: eggs, butter, cheese etc.
- lower door bins: beverages, cans, bottles

INFORMATION!

Do not store fruit (bananas, pineapples, papaya, citruses) and vegetables (zucchini, eggplant, cucumbers, bell peppers, tomatoes, and potatoes) sensitive to low temperatures in the refrigerator.

Freezer sections:

- freezing, storing frozen food (see chapter Freezing and storing frozen food).

INFORMATION!

Do not store the following in the freezer: lettuce, eggs, apples, pears, grapes, peaches, yoghurt, soured milk, sour cream, and mayonnaise.

Storing food in the refrigerator

Important warnings regarding food storage

INFORMATION!

Correct use of the appliance, appropriate packaging, maintaining the right temperature, and observing the food hygiene standards have a decisive impact on the quality of food storage.

Observe the expiry dates for the food, indicated on the packaging.

Food stored in the refrigerator should be kept in closed containers or in appropriate packaging to prevent it from emitting or receiving odours and humidity.

Do not store inflammable, volatile, and explosive substances in the refrigerator.

Bottles with high alcohol content should be tightly sealed and stored in an upright position.

Some organic solutions, essential oils in lemon and orange peel, butter acid, etc. may damage the plastic surfaces in case of a prolonged contact, causing damage and premature ageing of these materials.

Unpleasant odour warns of lacking cleanliness of the appliance or perished contents (see chapter Cleaning the Appliance).

If you are leaving home for a longer period of time, remove perishables from the refrigerator.

Avoid contamination of food

To avoid contamination of food, please respect the following instructions:

- Opening the door for long periods can cause a significant increase of the temperature in the compartments of the appliance.
- Regularly clean surfaces that can come in contact with food and accessible drainage systems.
- Store raw meat and fish in suitable containers in the refrigerator, so that it is not in contact with or drip onto other food.
- If the refrigerating appliance is left empty for long periods, switch off, defrost, clean, dry, and leave the door open to prevent mould developing within the appliance.

Freezing and storing frozen food

Freezing procedure

INFORMATION!

Maximum amount of fresh food that may be inserted at once is specified on the appliance rating plate. If the amount of food to be frozen exceeds the indicated amount, the quality of freezing will be inferior; in addition, the quality of the food already frozen will deteriorate.

- To make use of the entire freezer volume, remove all drawers.
- Activate the super freeze function 24 hours before freezing fresh food:
 - press the **H** key.

To make sure the food freezes as quickly as possible, lay out the packages as described below:

- Divide fresh food into smaller packages (1 kg). Place two packages against the back wall along the left and right edge of the upper drawer, one package in the middle in front of them (also in the upper drawer), and one package in the middle drawer, against the middle of the back wall.

Make sure the fresh food is not in contact with the food that is already frozen.

- When freezing smaller amounts of food (1-2 kilograms), activating the super freeze function is not required.

Important warnings on freezing

INFORMATION!

Only use the freezer to freeze food appropriate for freezing. Always use quality and fresh food.

Select the most suitable packaging for the food and use the packaging correctly.

Make sure the packaging is air and water tight so that the food does not dry out and lose its vitamins.

Indicate the type of food, amount, and date of freezing on the packaging.

It is important that the food freezes quickly. Therefore, smaller packages are recommended. Refrigerate the food before freezing.

Storing industrially frozen food

- When storing and using frozen food, observe the manufacturer's instructions. Temperature and expiry date are indicated on the packaging.
- Only choose food with undamaged packaging, stored in freezers at temperatures of $-18\text{ }^{\circ}\text{C}$ or lower.
- Do not purchase food covered in frost as this indicates it has been partly thawed several times and that it is of inferior quality.
- Protect the food from thawing during transport. In case of an increase in temperature, storage time will be shorter and quality will deteriorate.

Frozen food storage time

Recommended storage time in the freezer

Type of food	Storage life
Fruit, beef	from 10 to 12 months
Vegetables, veal, poultry	from 8 to 10 months
Venison	from 6 to 8 months
Pork	from 4 to 6 months
Finely chopped or minced meat	4 months
Bread, pastas, cooked dishes, whitefish	3 months
Offal	2 months
Smoked sausage, bluefish	1 month

Thawing frozen food

- Thawing is an important step in storing food preserved by freezing. Food must be thawed in the correct way.
- Suitable methods of thawing food are:
 - in the refrigerator;
 - in cold water;
 - in a microwave or conventional oven with a suitable thaw program.
- Some frozen products can be prepared without needing to thaw them first. The manufacturer will state this on the packaging.
- The food needs to be packed in small portions. In this way the food thaws faster.
- Use partially or completely thawed food as quickly as possible. The bacteria in thawed food are reactivated and the food will spoil rapidly. This applies in particular to fruit, vegetables and ready-made food.
- Do not refreeze partially or completely thawed food.

Defrosting the appliance

Automatic refrigerator defrosting

Refrigerator does not need defrosting because the ice on the back interior wall is thawed automatically. Any accumulated ice will melt when the compressor unit is inactive. Drops will flow through an opening in the refrigerator rear wall into a tray fitted above the compressor, from where they will evaporate.

Make sure the opening in the back wall in the refrigerator interior is never blocked by food or any other object.

If an excessive layer of ice is formed on the rear wall of refrigerator interior (3–5 mm), switch off the appliance and defrost the appliance manually.

Defrosting a NoFrost freezer

- The NoFrost freezer will defrost automatically. Any frost layer that may build up occasionally will disappear automatically.

Manual defrosting of the NoFrost freezer

- A layer of frost could build up on the appliance walls despite the NoFrost feature. This is usually a result of abnormal use of the appliance, such as too frequent door opening, leaving the door open for too long, poor door seal etc.

In such case, the freezer can be defrosted manually, according to the following procedure:

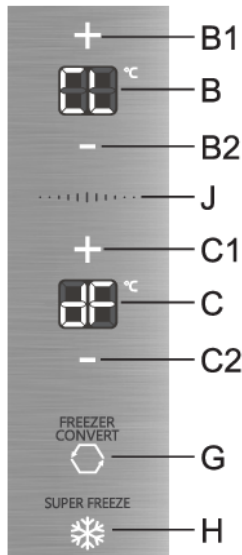

- **To activate:** Simultaneously press and hold the **G** and **H** key. A beep will be sounded, indication **CL** will appear on the **B** display unit, and indication **dF** will appear on the **C** display unit.
- **To deactivate:** When the defrosting process is complete, the function will be deactivated automatically. Set temperature will be indicated on display units **B** and **C**.



WARNING!

Do not use any defrosting sprays as they may melt the plastic parts or harm your health.



WARNING!

Do not use a knife or any other sharp object to remove the frost, because you may damage a pipe of the cooling system.

Cleaning the appliance



WARNING!

Before cleaning, unplug the appliance from the power mains – switch off the appliance (see chapter Switching the Appliance On/Off) and unplug the power cord from the wall outlet.

- Use a soft cloth to clean all surfaces. Cleaners that contain abrasive substances, acids, or solvents are not suitable for cleaning as they may damage the surface.

Clean the appliance exterior with water or a mild solution of suds.

Lacquer-coated and aluminium surfaces may be cleaned with lukewarm water to which you have added a mild detergent. Use of cleaners with low alcohol content is allowed (e.g. window cleaners). Do not use cleaners containing alcohol for cleaning plastic materials.

Appliance interior can be cleaned with lukewarm water to which you can add some vinegar.

- Do not wash the parts of appliance interior equipment in a dishwasher as they may be damaged.

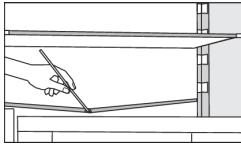

- A gutter and an opening for discharging the water from thawed frost deposits are located underneath the cooling panel that cools the refrigerator interior. The gutter and the opening may not be clogged. Inspect them often and clean if necessary (e.g. with a plastic straw).

- Frost or ice build-up, 3–5 mm thick, will increase power consumption. Therefore, it should be regularly removed (does not apply to NO FROST freezers). Do not use any sharp objects, solvents, or sprays.
- The condenser unit, located next to the compressor unit on the back of the appliance (only with some models), has to be kept clean, free of dust or other impurities. Occasionally clean it using a soft non-metal brush or a vacuum cleaner.
- After cleaning, switch the appliance back on and insert the food.

Troubleshooting

Problem:	Cause or remedy:
Appliance is connected to the power mains but it does not work.	<ul style="list-style-type: none"> • Make sure there is voltage in the power outlet and that the appliance is switched on.
Cooling system operates continuously for a long period of time:	<ul style="list-style-type: none"> • Too high environment temperature. • Door opened too frequently or too long. • Door not closed correctly (possible impurities on the seal, misaligned door, damaged seal etc.). • Too much fresh food inserted at once.
Excessive build-up of ice on the back wall of refrigerator interior can be a result of the following:	<ul style="list-style-type: none"> • Door opened too frequently or too long. • Warm food placed in the refrigerator. • Food or containers in contact with the back interior wall of the refrigerator. • Poor door sealing. • If the seal is dirty or damaged, clean or replace it.
Build-up of ice or frost in the freezer interior:	<ul style="list-style-type: none"> • The door has been opened for too long or too frequently. • The door is not properly closed. • The door has a poor seal (the gasket is dirty, the door is not properly aligned, the gasket is damaged etc.). • Manually defrost the appliance.
Condensate (dew) on the shelf above the drawers:	<ul style="list-style-type: none"> • This is transient phenomenon which cannot be entirely avoided in periods of high environment temperature and humidity. It subsides when temperature and humidity are normalized. We recommend cleaning the drawers more frequently and wiping the droplets occasionally. • Open the humidity control slider. • Put food in bags or other packaging with a good seal.
Water is dripping/leaking from the refrigerator:	<ul style="list-style-type: none"> • Clogged water discharge opening or water dripping past the water gutter. • Clean the blocked opening, e.g. using a plastic straw. • If a thick layer of ice builds up, defrost the appliance manually (see Defrosting the Appliance).
LED lighting does not work: 	<ul style="list-style-type: none"> • If LED lighting does not work, call a service technician. • Do not attempt a repair of the LED lighting yourself, as there is danger of contact with high voltage!
HI will appear on the display unit:	<ul style="list-style-type: none"> • Door opened too frequently or too long. • Door not closed correctly (possible impurities on the seal, misaligned door, damaged seal etc.). • An extended power failure.

Table continued from last page

Problem:	Cause or remedy:
	<ul style="list-style-type: none"> • Too much fresh food inserted at once.
PF will appear on the display unit:	<ul style="list-style-type: none"> • An extended power failure.
E0 or E8 appears on the display unit:	<ul style="list-style-type: none"> • Sensor keys are not responding. Call a service centre for repair. • Until the appliance is repaired by a service technician, the appliance will operate in safe mode. The appliance will automatically preserve the most suitable temperature for each compartment.
E1 or E2 appears on the display unit:	<ul style="list-style-type: none"> • Temperature sensor error or fault. Call a service centre for repair. Until the appliance is repaired by a service technician, the appliance will operate in safe mode. The appliance will automatically preserve the most suitable temperature for each compartment.
E3 appears on the display unit:	<ul style="list-style-type: none"> • Wi-Fi module failure. Call a service centre for repair. Until a service technician repairs the appliance, it will operate normally as a non-connectible appliance.
E9 appears on the display unit:	<ul style="list-style-type: none"> • Door was open for too long. Close the door. • If the lighting in the compartment does not function either, then there is a door sensor fault. Call a service centre to arrange a repair. The appliance will operate in safe mode until it is repaired. The appliance will automatically preserve the most suitable temperature for each compartment.
E4 appears on the display unit:	<ul style="list-style-type: none"> • Compartment fan failure. Call a service centre for repair. The appliance cannot operate normally. Transfer the food to a cool place and switch off the appliance.
E5 appears on the display unit:	<ul style="list-style-type: none"> • Condenser compartment fan failure. Call a service centre for repair. The appliance cannot operate normally. Transfer the food to a cool place and switch off the appliance.

Information about appliance noise

Cooling in refrigerator freezers is made possible by a cooling system that also includes a compressor (and a fan with some appliances), which generates some noise. The level of noise depends on installation, proper use, and age of the appliance.

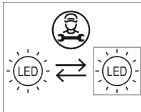
- After connecting the appliance to the power mains, compressor operation, or the sound of flowing liquid, may be somewhat louder. This is not a sign of malfunction and it will not affect the useful life of the appliance. In time, appliance operation and this noise will become quieter.
- Sometimes, unusual or loud noises may appear during appliance operation; these are mostly the result of improper installation:
 - The appliance must stand level and stable on a solid base.
 - The appliance may not be in contact with a wall or adjacent furniture.
 - Make sure the interior equipment sits firmly in its place and that the noise is not caused by rattling cans, bottles or other containers placed next to each other.
- Due to the higher workload on the cooling system when the door is opened more frequently or for a longer time, when a large amount of fresh food is introduced or when intensive freezing or cooling functions are activated, the appliance can temporarily generate more noise.

Hisense UK Ltd

Unit 2 Meadow Court Millshaw Lane Leeds, West Yorkshire, LS11 8LZ, United Kingdom

Hisense France SAS

9 Rue des 3 Soeurs, 93420 Villepinte, France

Hisense Germany GmbH

Garmischer Strasse 4-6, 80339 München, Germany

Hisense Italia SRL

Via Montefeltro, 6/A 20156 Milano, Italia

Hisense Iberia S.L

Ronda Auguste y Louis Lumiere, 23 Nave 12

Edificio Lumiere – Parque Tecnológico 46980 Paterna (Valencia). España

Gorenje gospodinjski aparati, d.o.o.

Partizanska cesta 12, 3320 Velenje, Slovenia

Hisense



865155-a4



We reserve the right to changes that do not affect the appliance functionality.