

**gorenje**

EN

GB

IE

## **DETAILED INSTRUCTIONS FOR USE OF A DRYER**

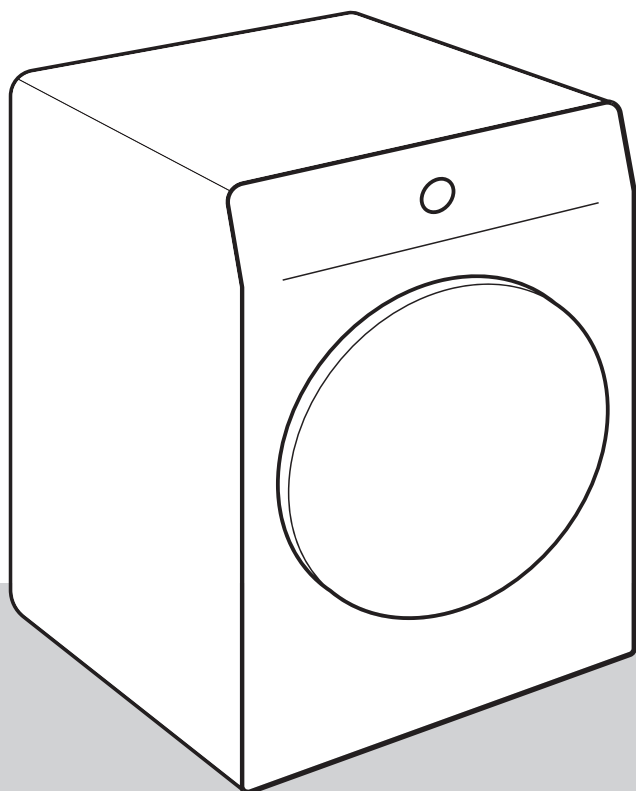

Life is complicated today. Let's make at least laundry care simple! Your new dryer uses innovative technology and the latest achievements in laundry care to help you simplify your daily household chores.

The technology offers the gentlest care for any garment, with minimum creasing. Moreover, your new dryer is also friendly to the environment as it uses power in the most economical way possible.

This dryer is intended solely for household use. Please do not use it to dry clothes that are not suitable for machine drying.

The following symbols are used throughout the manual and they have the following meanings:



**INFORMATION!**

Information, advice, tip, or recommendation



**WARNING!**

Warning – general danger



**ELECTRIC SHOCK!**

Warning – danger of electric shock



**HOT SURFACE!**

Warning – danger of hot surface



**DANGER OF FIRE!**

Warning – danger of fire



It is important that you carefully read the instructions.

# Contents

<b>SAFETY PRECAUTIONS</b> .....	<b>5</b>
Danger of hot surface .....	11
Safety .....	11
<b>DESCRIPTION OF THE DRYER</b> .....	<b>12</b>
Technical data .....	13
Control unit .....	14
<b>INSTALLATION AND CONNECTION</b> .....	<b>16</b>
Selecting the room .....	16
Dryer placement .....	16
Adjusting the dryer feet .....	19
Draining the condensate .....	20
Connecting to the power mains .....	21
Moving and transport after installation .....	22
<b>BEFORE USING THE APPLIANCE FOR THE FIRST TIME</b> .....	<b>23</b>
<b>DRYING PROCESS, STEP BY STEP (1 - 6)</b> .....	<b>24</b>
Step 1: Heed the labels on the laundry .....	24
Step 2: Preparing for the laundry drying process .....	25
Switching on the dryer .....	26
Loading the dryer .....	27
Step 3: Choosing the drying programme .....	28
Program chart .....	29
Step 4: Selecting extra functions .....	31
Extra function table .....	34
Step 5: Starting the drying programme .....	36
Step 6: End of the drying programme .....	36
<b>INTERRUPTIONS AND CHANGING THE PROGRAMME</b> .....	<b>37</b>
Interruptions .....	37
Changing the program/functions .....	37
Adding laundry after the start of the program .....	37
Saving personal settings .....	38
Personal settings menu .....	38
<b>CLEANING AND MAINTENANCE</b> .....	<b>39</b>
Cleaning the door net filter in the door .....	40
Cleaning of water condenser .....	40
Emptying the condensate tank .....	41
Cleaning the dryer .....	43
<b>TROUBLE-SHOOTING</b> .....	<b>44</b>
What to do ...? .....	44
Troubleshooting and error table .....	44
Sounds .....	47
Service .....	48
<b>TIPS FOR DRYING AND ECONOMIC USE YOUR DRYER</b> .....	<b>49</b>
<b>TYPICAL CONSUMPTION TABLE</b> .....	<b>50</b>
7 kg .....	50

8 kg .....	50
Low standby mode .....	51
<b>PRODUCT ENERGY LABEL AND PRODUCT FICHE .....</b>	<b>52</b>
<b>DISPOSAL .....</b>	<b>54</b>

# SAFETY PRECAUTIONS



**Carefully read the instructions for use before using the dryer.**

**Please, do not use the dryer without reading and understanding these instructions for use first.**

This appliance is not intended for use by persons (including children) with reduced physical, sensory or mental capabilities, or lack of experience and knowledge, unless they have been given supervision or instruction concerning use of the appliance by a person responsible for their safety.

**These instructions for use of a dryer are supplied with different types or models of dryers. Therefore, they may include descriptions of settings or equipment that are not available in your dryer.**

The maximum mass of dry textile material in kilograms to be used in the appliance.

**Failure to observe the instructions for use** or inappropriate use of the dryer may result in damage to the laundry or the appliance, or injury to the user. Keep the instruction manual handy, near the dryer.

Instructions for use are available on our website at [www.gorenje.com](http://www.gorenje.com).

**Your dryer is intended solely for household use.** If the dryer is used for professional, for-profit purpose or purpose exceeding normal use in a household, or if the dryer is used by a person who is not a consumer, the warranty period shall be equal to the shortest warranty period required by relevant legislation.

Follow the instructions for correct installation of the Gorenje dryer and connection to the power mains (see chapter »INSTALLATION AND CONNECTION«).

All and any repairs or maintenance tasks on the dryer should only be done by trained experts. Unprofessional repair may result in an accident or major malfunction.

 **ELECTRIC SHOCK!**

To avoid danger, a **damaged power cord** may only be replaced by the manufacturer, a service technician, or an authorized person.

**After installation, the dryer should stand still for two hours before it is connected to the power mains.**

 **WARNING!**

Do not connect the dryer to power mains using an external switching device such as a programme timer, or connect it to power mains that is regularly switched on and off by the power supply provider.

The dryer shall not be connected to the power mains using an extension cord.

Do not connect the tumble dryer to an electrical outlet intended for an electric shaver or a hair dryer.

In case of a defect, only use approved spare parts by authorized manufacturers.

In case of incorrect dryer connection, incorrect use, or servicing by an unauthorized person, the user shall bear the cost of any damage as such damage shall not be covered by warranty.

Always use the hoses supplied with the dryer.

Install the dryer in a room with adequate ventilation and a temperature between 15°C and 25°C.

At least two persons are required to install the tumble dryer on top of a washing machine.

Place the dryer on a level and stable solid (concrete) base.

The appliance must not be installed behind a lockable door, a sliding door or a door with a hinge on the opposite side to that of the tumble dryer, in such a way that a full opening of the tumble dryer door is restricted.

Never block the air exhaust (evacuation opening).

For appliances with ventilation openings in the base, a carpet must not obstruct the openings.

**The air in the room where the dryer is installed may not contain dust particles.**

**Adequate ventilation has to be provided** to avoid the back flow of gases into the room from appliances burning other fuels, including open fires.

The lint must not to be allowed to accumulate around the tumble dryer.

The appliance may not be in contact with a wall or adjacent furniture.

Do not dry unwashed items in the tumble dryer.

Items that have been soiled with substances such as cooking oil, acetone, alcohol, petrol, kerosene, spot removers, turpentine, waxes and wax removers should be washed in hot water with an extra amount of detergent before being dried in the tumble dryer.

Items such as foam rubber (latex foam), shower caps, waterproof textiles, rubber backed articles and clothes or pillows fitted with foam rubber pads should not be dried in the tumble dryer.

Fabric softeners, or similar products, should be used as specified by the fabric softener instructions.

 **DANGER OF FIRE!**

Remove all objects from pockets such as lighters and matches.

If the condensate tube is blocked or clogged, then tumble dryer operation is stopped (see chapter »PAUSING AND CHANGING THE PROGRAMME/Full condensate tank«).

Before moving the dryer or before storing it in a non-heated room during the winter, the condensate tank has to be emptied.

**That the lint trap has to be cleaned frequently, if applicable.**



**Clean the dryer filter after each drying cycle.** If you have removed the filter, replace it before the next drying cycle.

**After each cleaning cycle, replace the condenser unit into the air duct.** Dryer operation without the condenser unit or with a damaged condenser unit is hazardous and could result in a fire (see chapter »DESCRIPTION OF THE DRYER and CLEANING THE CONDENSER UNIT«).

**Do not use any solvents or cleaning agents that could damage the dryer** (please observe the recommendations and warnings provided by the manufacturers of the cleaning agents).

**Never add chemicals or fragrances into the condensate tank** (see chapter »DESCRIPTION OF THE DRYER and EMPTYING THE CONDENSATE TANK«).

**After the drying process, unplug the dryer power cord from the power outlet.**

**The warranty does not cover** consumables, minor deviations in colour, increased noise that results from appliance age and which does not affect the functionality of the dryer, and aesthetic defects on components, which do not affect the dryer's functionality and safety.

 **WARNING!**  
**Child safety**

**Children should be supervised to ensure that they do not play with the appliance.**

**Children of less than 3 years should be kept away unless continuously supervised.**

Prevent your children and pets from entering the dryer drum.

Before closing the dryer door and running the programme, make sure there is nothing except laundry in the drum (e.g. if a child climbed into the dryer drum and closed the door from the inside).

**Activate the Child lock.** See chapter »STEP 4: SETTING THE EXTRA FUNCTIONS/Child lock«.

**The dryer is made in compliance with all relevant safety standards.**

This appliance can be used by children aged from 8 years and above and persons with reduced physical, sensory or mental capabilities or lack of experience and knowledge if they have been given supervision or instruction concerning use of the appliance in a safe way and understand the hazards involved.

Children shall not play with the appliance.

Cleaning and user maintenance shall not be made by children without supervision.

## Danger of hot surface



### **HOT SURFACE!**

**The back of the dryer may get very hot during operation. Wait for the dryer to cool down completely before touching its back side.**

If you open the dryer door during the drying process, the clothes may be very hot and there is a risk of burning.

Never stop the drying process before it is completed; if you do interrupt the cycle for any reason, be careful when removing the laundry from the drum as it is very hot. Quickly remove the laundry from the drum and spread it to allow it to cool down as quickly as possible.

## Safety



### **DANGER OF FIRE!**

Only use the dryer to dry laundry that was washed with water. Do not dry any laundry that was washed or cleaned with flammable cleaners or substances (such as gasoline, trichloroethylene etc.) as this may result in an explosion.

The tumble dryer is **not to be used** if industrial chemicals have been used for cleaning.

The dryer is protected with an automatic switch-off system in case of overheating. This system will switch off the dryer if the temperature is too high.

If the net filter is clogged, the overheating automatic switch-off system may be activated. Clean the filter, wait for the dryer to cool down, and try running it again. If the dryer still fails to start, call a service technician.

# DESCRIPTION OF THE DRYER

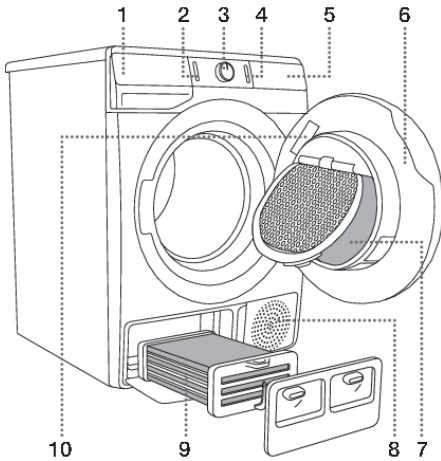

## FRONT

1. Condensate tank
2. On/off button
3. Program selector knob
4. Start/pause button
5. Control unit
6. Door
7. Net filter
8. Air vent
9. Condenser unit
10. Rating plate

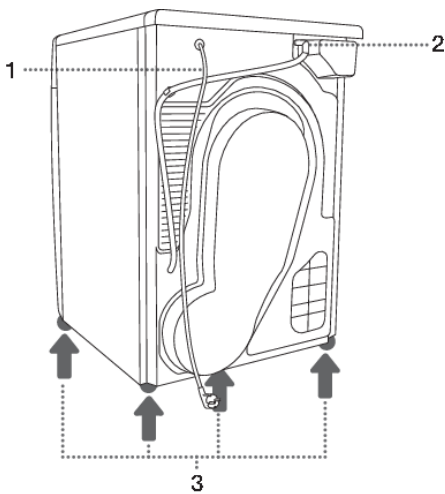

## BACK

1. Power cord
2. Condensate discharge hose
3. Adjustable feet





# Technical data

(depending on the model)

Rating plate with basic information about the dryer is located on the inner side of the dryer door (see chapter »DESCRIPTION OF THE DRYER«).

<b>Width</b>	600 mm
<b>Height</b>	850 mm
<b>Dryer depth (a)</b>	625 mm
<b>Depth with door closed</b>	653 mm
<b>Depth with door open (b)</b>	1134 mm
<b>Weight</b>	XX/YY kg (depending on the model)
<b>Rated voltage</b>	See rating plate
<b>Fuse</b>	See rating plate
<b>Nominal power</b>	See rating plate
<b>Maximum load</b>	See rating plate

Rating plate

<b>gorenje</b>	TYPE:SP22/XXXXX	MODEL:XXXXXXXXXXXXX		<b>MADE IN SLOVENIA</b>
	ART.No.:XXXXXX/XX	Ser.No.:XXXXXXXX		
	XXX-XXX V - XX Hz	⊕ XX A	○ XX kg	 <small>GORENJE gospodinjiski aparati d.o.o. Partizanska cesta 12 SI-3320 Velanje, SLOVENIA info@gorenje.com</small>
	Pmax.XXXX W	 XXXX W		
AUID:XX				

# Control unit

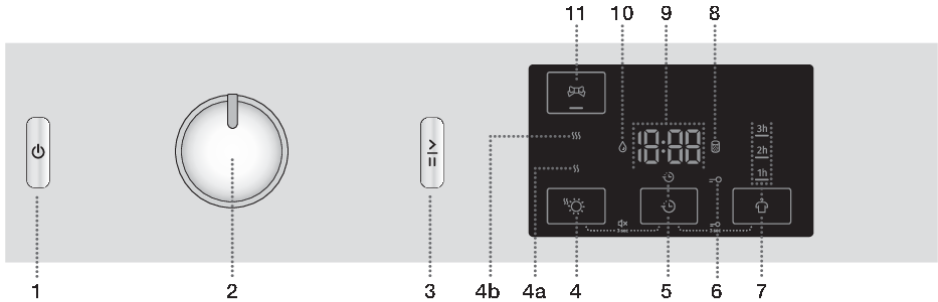

## 1 ON/OFF BUTTON

Switching the dryer on and off.

## 2 PROGRAMME SELECTOR KNOB

## 3 START/PAUSE BUTTON

Use this button to start or stop the programme.

Upon start-up or during pause, the button light will flash; when the programme is started and in progress, it will be lit continuously.

## 4 EXTRA DRY ☀️ (DRYNESS LEVEL)

The symbol is lit when the function is selected.

Extra functions **4a** ☹️ and **4b** ☹️☹️ allow selecting a higher dryness level and extend the drying time.

## 5 DELAY END ⌚ (DELAYING THE END OF THE DRYING PROGRAM)

Option to set the time when the drying will end.

## 4+5 Sound ON/OFF

Press the positions 4+5 and hold them for 3 seconds.

## 6 CHILD LOCK ⚡ lighting

## 5+7 Child lock ON/OFF

Press the positions 5+7 and hold them for 3 seconds.

## 7 ANTI CREASE ⏸️ (CREASE PREVENTION)

A light will be on under the selected function operating time.

Table continued from last page

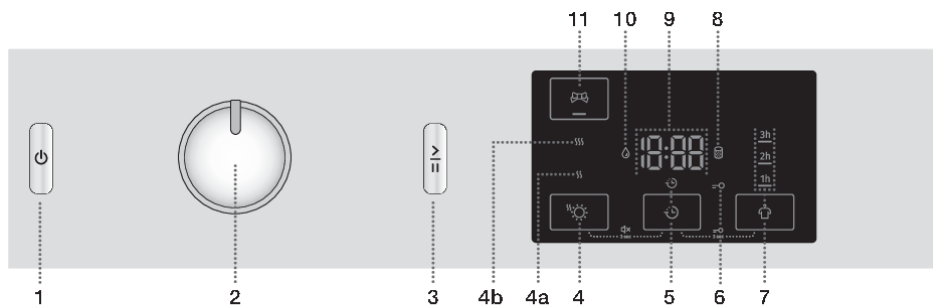

**8** Lighting of the symbol   
**CLEAN THE FILTER**

**9** The following is displayed on the **DISPLAY UNIT**:

- Available functions;
- Time remaining to programme completion;
- Information for the user.

**10** Lighting of the symbol   
**EMPTY THE CONDENSATE TANK**

**11** **GENTLE CARE**  (LOWER TEMPERATURE)

Option to set a lower drying temperature.

# INSTALLATION AND CONNECTION



## INFORMATION!

Remove all packaging. When removing the packaging, make sure not to damage the dryer with a sharp object.

## Selecting the room

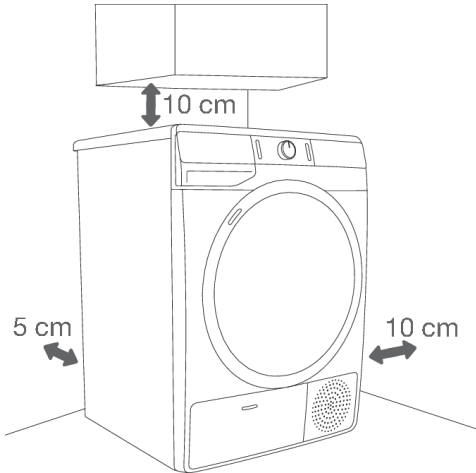

## INFORMATION!

The dryer may not be in contact with a wall or adjacent furniture. For optimum dryer operation, we recommend observing the clearance from the walls as indicated in the figure. In case of failure to heed the required minimum clearance, the dryer may overheat.



## INFORMATION!

Vents on the back wall and the air exhaust opening on the front side of the dryer should never be obstructed.

The room in which you will install the dryer should be sufficiently ventilated, with a temperature between 15°C and 25°C. Dryer operation at a lower environment temperature may result in condensate accumulation in the dryer interior. Do not place the dryer into a place where there is danger of freezing. Frozen water in the condensate tank and pump may damage the dryer.

The dryer emits heat. Therefore, do not place it in a very small room, as the drying process may take longer due to limited amount of available air.

Lighting in the room should be sufficient to allow reading the information on the display unit on the control panel.

## Dryer placement

If you also have a Gorenje dryer of corresponding (same) dimensions, it can be placed on top of the Gorenje washing machine; in this case, vacuum feet must be used and wall fixing bracket. Alternatively, the dryer can be placed next to the washing machine (figures 1 and 3).



If your Gorenje washing machine is smaller (minimum depth 545 mm), than your Gorenje dryer, then the dryer support has to be purchased extra (figure 2). The supplied vacuum feet must be used; they are designed to prevent the dryer from slipping.

Additional equipment: tumble dryer bracket (a), vacuum feet (b) (if not supplied) and wall fixing bracket (c), can be purchased at the service centre.

The surface on which the appliance is placed should be clean and level.

Gorenje washing machine onto which you intend to place the Gorenje dryer should hold the weight of the Gorenje dryer (see chapter »WASHING MACHINE DESCRIPTION/Technical information«).

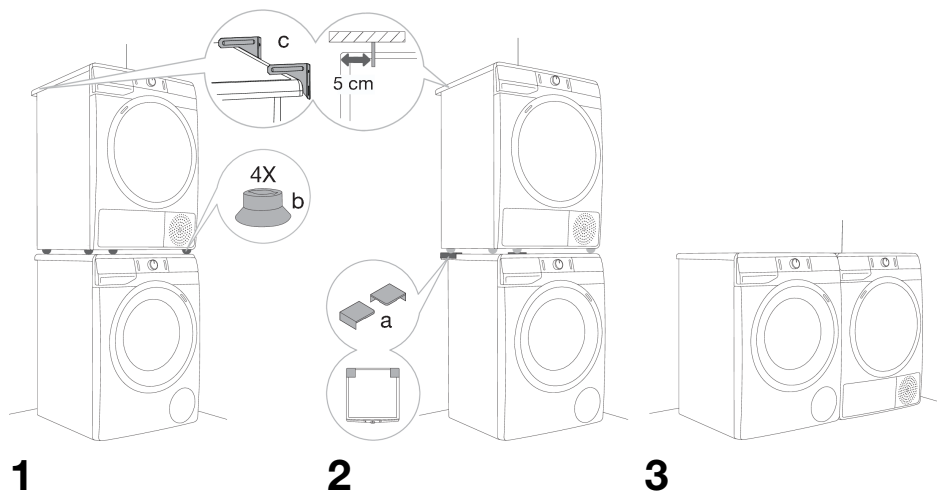

**⚡ INFORMATION!**

At least two persons are required to install the tumble dryer on top of a washing machine.

**Opening the dryer door (top view)**

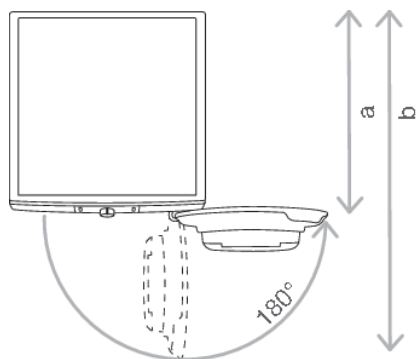

See chapter »DESCRIPTION OF THE DRYER/Technical information«.

a = 625 mm  
b = 1134 mm



**WARNING!**

The appliance must not be installed behind a lockable door, a sliding door or a door with a hinge on the opposite side to that of the tumble dryer, in such a way that a full opening of the tumble dryer door is restricted.



**WARNING!**

For appliances with ventilation openings in the base, a carpet must not obstruct the openings.

## Adjusting the dryer feet

Level the dryer in longitudinal and traverse direction by rotating the adjustable feet which allow levelling by +/- 1 cm. Use a spirit level and spanner No. 22.

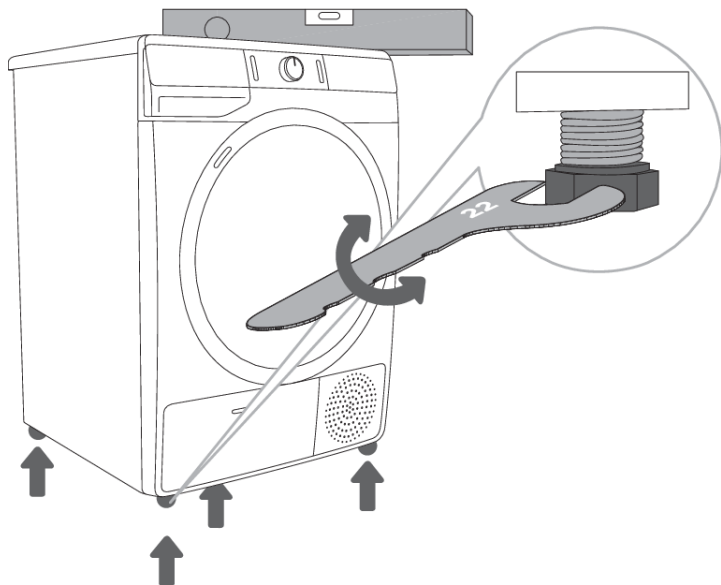

**-💡- INFORMATION!**

Floor on which the dryer is placed must have a concrete base. It should be clean and dry; otherwise, the dryer may slide. Also clean the adjustable feet.

**-💡- INFORMATION!**

The dryer must stand level and stable on a solid base.

**-💡- INFORMATION!**

Incorrect levelling of the dryer with the adjustable legs may cause vibration, appliance sliding across the room, and loud operation. Incorrect levelling of the dryer shall not be subject to warranty.

**-💡- INFORMATION!**

Sometimes, unusual or louder noise may appear during appliance operation; these are mostly the result of improper installation.

# Draining the condensate

The moisture from the laundry is extracted in the condenser unit and accumulated in the condensate tank.

During the drying process, an indicator light (symbol  (10)), is lit on the display unit) warns when the condensate tank is full and needs to be emptied.

To avoid emptying the condensate tank, run the condensate discharge hose located at the back of the appliance directly into a drain.

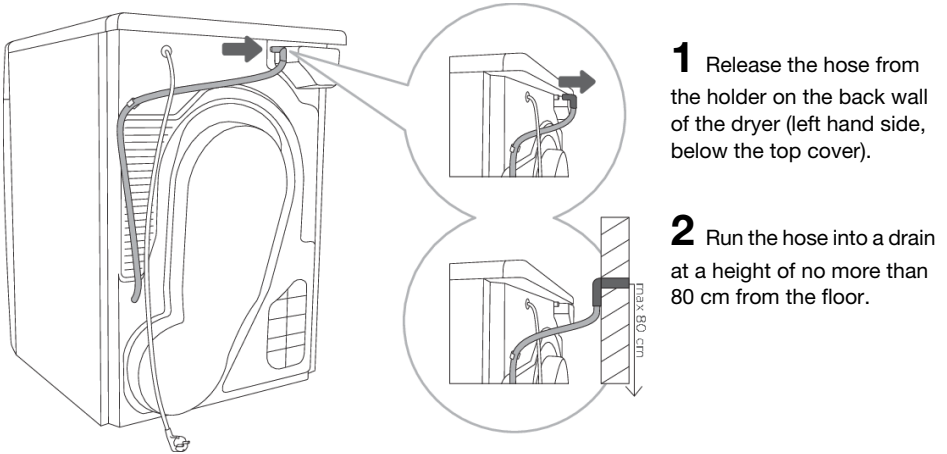

**1** Release the hose from the holder on the back wall of the dryer (left hand side, below the top cover).

**2** Run the hose into a drain at a height of no more than 80 cm from the floor.



## INFORMATION!

If you decide to run the condensate drain hose into a drain, make sure the hose is securely fastened. This will prevent any water spillage which could result in unexpected damage.



## WARNING!

Always use the hoses supplied with the dryer.

## Connecting to the power mains

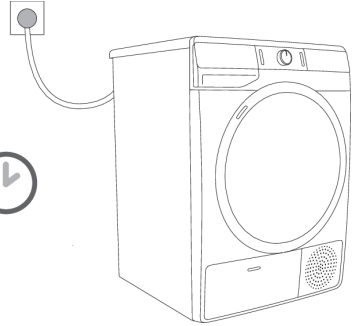
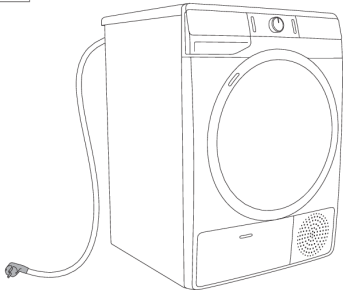

### **ELECTRIC SHOCK!**

**After installation, the dryer should stand still for two hours before it is connected to the power mains; this allows the dryer to stabilize.**

Connect the dryer to a grounded power outlet. After installation, the wall outlet should be freely accessible. The outlet should be fitted with an earth contact (in compliance with the relevant regulations).

Information on your dryer is indicated on the rating plate (see chapter »DESCRIPTION OF THE DRYER/Technical information«).



### **ELECTRIC SHOCK!**

**We recommend using over-voltage protection to protect the appliance in case of a lightning strike.**



### **WARNING!**

The dryer shall not be connected to the power mains using an extension cord.



### **INFORMATION!**

Do not connect the tumble dryer to an electrical outlet intended for an electric shaver or a hair dryer.



### **INFORMATION!**

Any repair and maintenance pertaining to safety or performance should be done by trained experts.



### **INFORMATION!**

A damaged power cord may only be replaced by a person authorized by the manufacturer.

## Moving and transport after installation

After every drying cycle, a small amount of condensed water will remain in the dryer. Switch on the dryer and choose one of the programmes, then let the appliance operate for approximately half a minute. This will pump out the remaining water and prevent damage to the dryer during transport.



### **ELECTRIC SHOCK!**

**After transport, the dryer should be left to stand still for at least two hours before it is connected to the power mains. The appliance should be installed and connected by a trained technician.**



### **INFORMATION!**

If the appliance was not transported in compliance with the instructions, the dryer should be left to stand still at least two hours before it is reconnected to the power mains.



### **ELECTRIC SHOCK!**

**Carefully read the instructions for use before connecting the dryer. Repair or any warranty claim resulting from incorrect connection or use of the dryer shall not be covered by the warranty.**



### **INFORMATION!**

The belt may only be replaced by a service technician authorized by the manufacturer, who can supply the original spare part with the code OPTIBELT EPH 1906, code 104265; OPTIBELT 8 EPH 1941, code 160165; POLY-V 7PH 1956 HUTCHINSON, code 562038; HUTCHINSON 8 PHE 1942, code 270313 (depending on the model).

# BEFORE USING THE APPLIANCE FOR THE FIRST TIME

Make sure the dryer is disconnected from the power mains; then, open the door by pulling the left side of the door towards you (figures 1 and 2).

Before using the dryer for the first time, clean the dryer drum using a soft damp cotton cloth and water (figure 3).

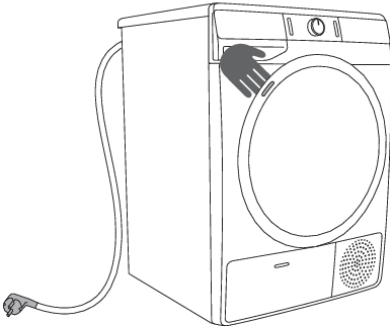

1

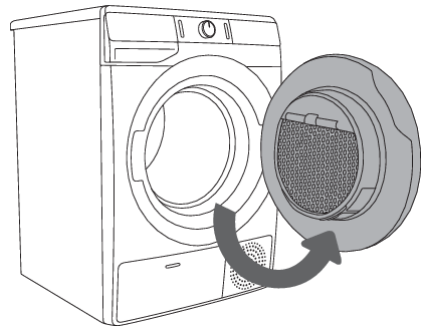

2



3

























## WARNING!

Do not use any solvents or cleaning agents that could damage the dryer (please observe the recommendations and warnings provided by the manufacturers of the cleaning agents).

# DRYING PROCESS, STEP BY STEP (1 - 6)

## Step 1: Heed the labels on the laundry

<b>Normal wash; Sensitive laundry</b>			
	Max. washing temp. 95°C		Max. washing temp. 40°C
	Hand wash only		
	Max. washing temp. 60°C		Max. washing temp. 30°C
	Do not wash		
<b>Bleaching</b>			
	Bleaching in cool water		Bleaching not allowed
<b>Dry cleaning</b>			
	Dry cleaning with all agents		Petroleum solvent R11, R113
	Dry cleaning in kerosene, pure alcohol, and R113		Dry cleaning not allowed
<b>Ironing</b>			
	Hot ironing, max. 200°C		Hot ironing, max. 110°C
	Hot ironing, max. 150°C		Ironing not allowed
<b>Drying</b>			
	Dry flat (place on a flat surface)		High temperature
	Drip dry		Low temperature
	Line dry		Tumble drying not allowed



## Step 2: Preparing for the laundry drying process

1. Sort the laundry by type and thickness of the fabric (see PROGRAMME TABLE).
2. Close the buttons and zips, tie any ribbons, and turn the pockets inside out.
3. Place very sensitive clothes in a special-purpose laundry bag.  
(The special-purpose laundry bag is available as an optional accessory.)

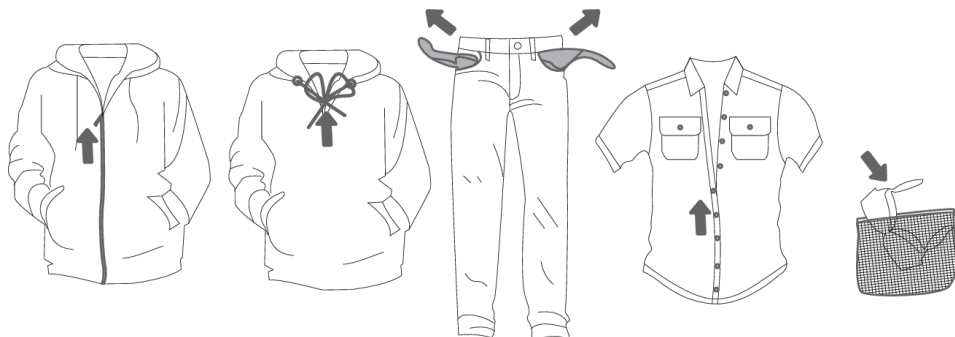

**Drying laundry made of particularly delicate fabrics that may be deformed is not recommended. The following types of laundry may not be dried in the dryer as this may cause your garments to deform:**

- leather garments and other leather products,
- garments that are waxed or treated in any other way,
- garments with major wooden, plastic, or metal parts;
- garments with spangles;
- garments with metal parts subject to rusting.

# Switching on the dryer

Connect the dryer to the power mains by plugging in the power cord.

Press the (1) **ON/OFF** button to switch on the dryer (figure 1).

**With some models**, the dryer drum is lit as well (figure 2).

(The light in the dryer drum is not suitable for any other use.)



## **INFORMATION!**

The light in the dryer drum may only be replaced by the manufacturer, a service technician or an authorized person.

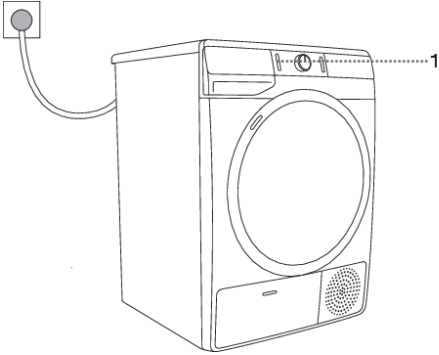

**1**

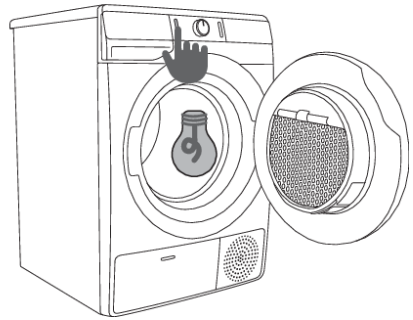

**2**

## Loading the dryer

Open the dryer door by pulling the left side of the door towards you (figure 1).

Insert the laundry into the drum (after making sure the drum is empty) (figure 2).

Close the dryer door (figure 3).

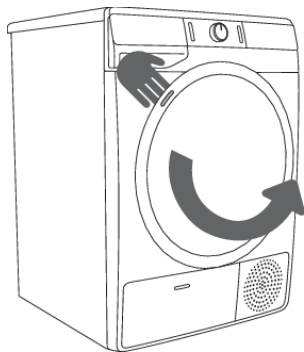

1

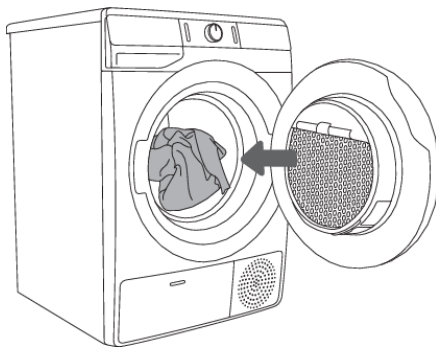

2

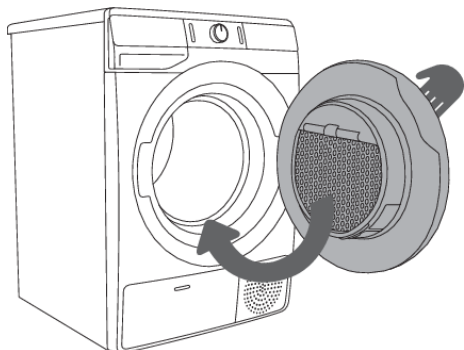

3



### INFORMATION!

Do not insert laundry into the dryer if it has not been wrung or spun (recommended minimum spinning cycle: 800 rpm).

Do not overload the drum! See PROGRAMME TABLE and observe your nominal load as indicated on the rating plate.

If the dryer drum is overloaded, the laundry will be more wrinkled and perhaps unevenly dried.



### INFORMATION!

When drying larger items (bedding, towels, tablecloths etc.), loosen them and then insert them into the dryer drum.

### Step 3: Choosing the drying programme

Choose the **programme** by rotating the programme selector knob (2) to the left or to the right (depending on the type of laundry and the desired level of dryness). See PROGRAMME TABLE.

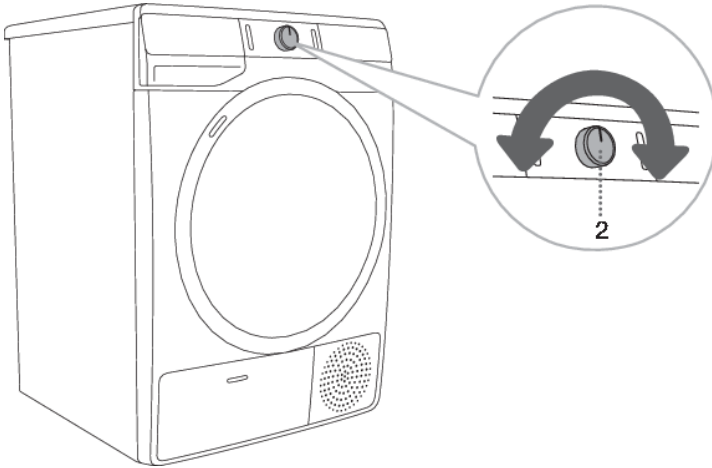

#### **INFORMATION!**

The programme selector knob (2) will not rotate automatically during operation.

## Program chart













Program Dryness levels		Max. load	Programme description
<b>Cotton (Cotton)</b>			
	Storage (Cupboard dry)	7 kg 8 kg	Use this programme for thicker non-sensitive cotton laundry. After drying, it will be dry and ready to be stored in the cupboard.
	Standard* □	7 kg 8 kg	Use this programme for thicker non-sensitive cotton laundry of approximately the same thickness. After drying, it will be dry.
	Iron (Moist for ironing)	7 kg 8 kg	Use this program for non-sensitive cotton laundry. After drying, it will be ready for ironing.
	<b>Mix (Mixed laundry)</b>	3,5 kg	The program is used for drying cotton and synthetic laundry at the same time.
	<b>Synthetics (Synthetics)</b>	3,5 kg	The program is used for drying synthetic and blended textiles.
	<b>Wool (Wool)</b>	2 kg	This short program is intended for softening or fluffing of clothes made of wool and silk, which have to be dried thoroughly according to manufacturer's instructions.
	<b>Pillow (Feathers/Down)</b>	1,5 kg	Use this programme to dry apparel stuffed or padded with down (pillows, jackets,...). Dry large items separately and use the EXTRA DRY (DRYNESS LEVEL) function if necessary.
	<b>Air refresh (Airing)</b>	2 kg	In this programme, the heater is switched off. The programme is suitable for refreshing your laundry.
	<b>Bedding (Bedding)</b>	5 kg	Use this programme for larger items. When the programme is complete, they will be dry. Adjusted drum rotation prevents the laundry from tangling.
	<b>Baby (Baby clothes)</b>	4 kg	Use this programme to dry baby clothes. Clothes dried with this programme are usually normally dry.
	<b>Sensitive (Delicate)</b>	1 kg	Use this programme to dry highly delicate laundry made of synthetic fibres, which may be slightly moist after the drying process. We recommend using a special-purpose laundry bag.
	<b>Shirts (Shirts)</b>	2 kg	Use this program to dry shirts and blouses. Adjusted drum rotation prevents the laundry from creasing.
	<b>Sports (Sportswear)</b>	3 kg	Use this programme for clothing with a membrane, for sportswear made of mixed materials, and breathable fabrics.
	<b>Time dry (Timed program)</b> 60' 30'	4 kg	Use this programme for non-sensitive laundry that is still slightly moist and has to be thoroughly dried. In the time programme, remaining moisture is not detected automatically. If the laundry is still damp after the programme is complete, repeat the programme; if it is too dry and therefore creased and rough to touch, the drying time you selected was too long.

Table continued from last page

<b>Program Dryness levels</b>	<b>Max. load</b>	<b>Programme description</b>
<b>Fast 89' (Fast 89')</b>	4 kg	The program is suitable for smaller amounts of laundry that you wish to dry quickly and efficiently.

\* Standard programme for cotton laundry pursuant to the currently effective regulation EU 392/2012

If your laundry is not dried to the desired dryness level, use extra functions or use a more suitable programme.

## Step 4: Selecting extra functions



### INFORMATION!

Activate/deactivate the function by pressing the desired position (before pressing the (3) START/PAUSE button).

Adjust the settings by pressing the relevant function button (before pressing the (3) START/PAUSE button).

Functions that can be changed or adjusted with the selected drying programme are partly lit (dimmed).

Certain settings cannot be selected with some programmes. Such settings will not be lit, and the button will flash when pressed (see FUNCTION TABLE).

Description of lighting of functions for the selected drying programme:

- **Lit** (Basic/preset setting);
- **Dimmed** (Functions that can be adjusted) and
- **Unlit** (Functions that cannot be selected).

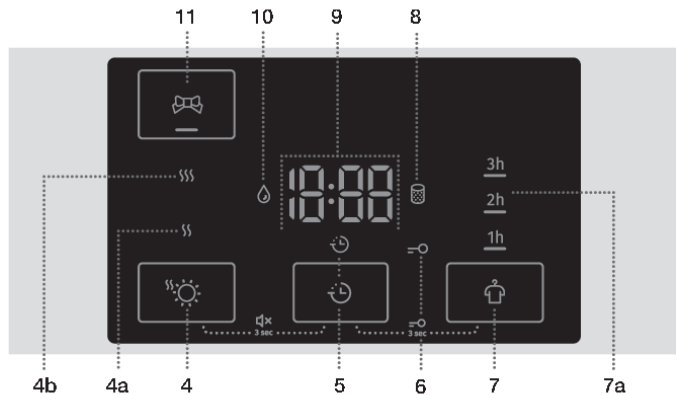

### EXTRA DRY (DRYNESS LEVEL)

Press on the (4) **EXTRA DRY (DRYNESS LEVEL)** position to adjust - increase the dryness level and the drying duration. This setting can be adjusted before the start of the drying process. After the drying programme, this setting is not stored.

Two levels of extra dryness and longer drying time are available. Extra functions (4a)  $\text{SS}$  and (4b)  $\text{SSS}$  allow selecting a higher dryness level and extend the drying time. The light on the selected drying mode will be lit up.



### DELAY END (DELAYING THE END OF THE DRYING PROGRAM)

Press on the (5) **DELAY END (DELAYING THE END OF THE DRYING PROGRAM)** to delay the drying end time by up to 24 hours.

Settings procedure:

- Select the desired programme and extra functions.
- Press on the (5) **DELAY END** position (DELAYING THE END OF THE DRYING PROGRAM) to activate the function.
- Repeatedly press this position to set the desired drying completion time (with 30-minute increments up to 6 hours, and 1-hour increments thereafter, up to 24 hours).
- The function is activated when the (3) **START/PAUSE** key is pressed.

The dryer starts counting down the time. When the countdown reaches the drying programme duration (e.g. 2:30), the drying programme starts automatically.

To interrupt or change the drying programme completion time, press (1) ON/OFF. To quickly cancel the programme completion delay, press the position (5) **DELAY END** (DELAYING THE END OF THE DRYING PROGRAM) and hold it for 3 seconds. The drying program will resume.

Example of function setting:

If you wish the drying programme end at 6:00 in the morning and it is now 21:00, then set the **DELAY END** (DELAYING THE END OF THE DRYING PROGRAM) to 9 hours.



#### **ANTI CREASE** (CREASE PREVENTION)

If you do not remove the laundry from the dryer immediately after the completion of the drying programme, we recommend using the (7) **ANTI CREASE** (CREASE PREVENTION) function that has to be selected before the start of the drying process.

Press on the position (7) **ANTI CREASE** (CREASE PREVENTION) to choose between 1h, 2h, and 3h (7a) or to deactivate this function. When you open the dryer door after the completion of the drying programme, the function is automatically deactivated.



#### **GENTLE CARE** (LOWER TEMPERATURE)

For delicate laundry. Lower temperature depends on the programme for which the drying was selected. This setting can be adjusted before the start of the drying process. After the drying programme, this setting is not stored.



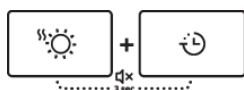
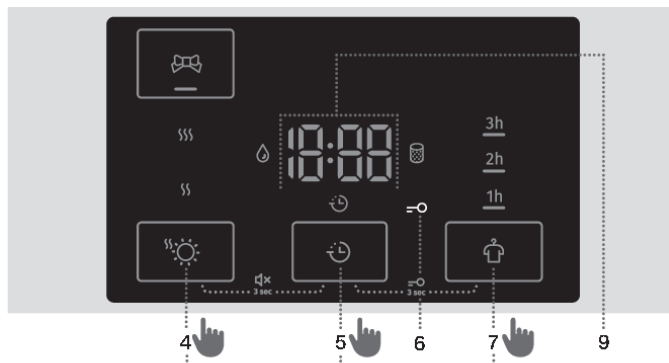

### SOUND OFF

To turn off the sound, simultaneously press the positions (4) **EXTRA DRY** ☀️ (DRYNESS LEVEL) and (5) **DELAY END** ⌛ (DELAYING THE END OF THE DRYING PROGRAM) and hold them for at least 3 seconds.

To reactivate the sound, simultaneously press the positions (4) and (5) and hold them for at least 3 seconds. If you turn off the sound, then there is no audible signal at the end of a drying programme.

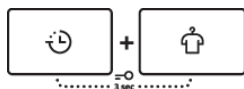

### CHILD LOCK

To activate or deactivate the child lock, simultaneously press the positions (5) **DELAY END** ⌛ (DELAYING THE END OF THE DRYING PROGRAM) and (7) **ANTI CREASE** 🛡️ (CREASE PREVENTION) and hold them for at least 3 seconds until the symbol ⚔️ (6) lights up or goes off, respectively.

If the child lock is activated, programme or additional functions cannot be changed. The child lock remains active after the dryer is switched off. Therefore, it has to be deactivated before a new programme can be selected. It can also be switched off during the drying process.

















### 💡 INFORMATION!

Some functions are not available and cannot be selected with certain programmes; an acoustic signal and a flashing light will indicate such cases (see EXTRA FUNCTION TABLE).

### 💡 INFORMATION!

After disconnecting the dryer from the power mains, all settings will be reset to their default factory values, except for the acoustic signal loudness, anti-crease, and child lock setting.

## Extra function table

Programmes		EXTRA DRY  (DRYNESS LEVEL)	DELAY END  (DELAYING THE END OF THE DRYING PROGRAM)	ANTI CREASE  (CREASE PREVENTION)	GENTLE CARE  (LOWER TEMPERATURE)
<b>Cotton (Cotton)</b>					
	Storage (Cupboard dry)	•	•	•	•
	Standard* □	•	•	•	•
	Iron (Moist for ironing)	•	•	•	•
	<b>Mix</b> (Mixed laundry)	•	•	•	•
	<b>Synthetics</b> (Synthetics)	•	•	•	•
	<b>Wool</b> (Wool)				
	<b>Pillow</b> (Feathers/Down)	•	•	•	•
	<b>Air refresh</b> (Airing)				
	<b>Bedding</b> (Bedding)	•	•	•	•
	<b>Baby</b> (Baby clothes)	•	•	•	•
	<b>Sensitive</b> (Delicate)	•	•	•	
	<b>Shirts</b> (Shirts)	•	•	•	•
	<b>Sports</b> (Sportswear)	•	•	•	•
	<b>Time dry</b> (Timed program) 60' 30'			•	•
	<b>Fast 89'</b> (Fast 89')		•	•	

- Additional functions can be used

If your laundry is not dried to the desired dryness level, use extra functions or use a more suitable programme.

## Step 5: Starting the drying programme

Press the button (3) **START/PAUSE**.

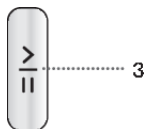

## Step 6: End of the drying programme

At the end of the drying programme, **End** »(End)« will appear on the display unit, the two red indicator lights will light up, the (3)START/PAUSE button light will flash, and the light for selected time display **ANTI CREASE** (CREASE PREVENTION) (7a), if activated or selected, will flash.



1. Open the dryer door.
2. Clean the filter (see section »CLEANING« ...).
3. Take the laundry from the drum.
4. Close the door!
5. Switch off the dryer (press the (1) **ON/OFF** button).
6. Empty the condensate tank.
7. Unplug the power cord from the outlet.

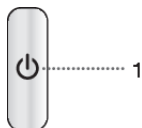

### **INFORMATION!**

After the end of the drying programme, immediately remove the laundry from the dryer to prevent it from creasing again.

### **WARNING!**

The final drying cycle includes a cooling down stage without heater operation. It makes sure the laundry is of suitable temperature at the end of the program and that it can be taken from the dryer without risk of touch hot clothes.

# INTERRUPTIONS AND CHANGING THE PROGRAMME

## Interruptions

### Interrupting the programme process

Press the (3) START/PAUSE button to pause/resume a programme.

To stop and cancel the drying programme, press the (3) START/PAUSE button and hold it for 3 seconds. The selected programme will stop, and the dryer will start to cool down. Cooling down time depends on the selected programme. After this process, the drying programme can be selected again.

### Open door

If the dryer door is opened during the drying process, the drying cycle will be interrupted.

When the door is closed and the (3) START/PAUSE button is pressed, the drying will resume from the point at which it was interrupted.



### **HOT SURFACE!**

**The dryer door will heat up during the drying process. Make sure you do not burn yourself when opening the dryer door.**

### Full condensate tank

When the condensate tank is full, the drying programme will pause (symbol  (10)) will be lit up).

Empty the condensate tank (see chapter »CLEANING AND MAINTENANCE/Emptying the condensate tank«).

Press the (3) START/PAUSE button to resume the drying programme from the point at which it was interrupted.

### Power supply failure

When power supply is resumed, the signal light on the (3) START/PAUSE button will flash.

To resume the drying process, press the (3) START/PAUSE button.

## Changing the program/functions

Switch off the dryer by pressing the button (1) ON/OFF; then, switch it on again by pressing the button (1) ON/OFF and rotate the (2) programme selector knob to the desired programme, or choose extra functions.

Select another program/function and press the (3) START/PAUSE button again.

## Adding laundry after the start of the program

Open the dryer door and press the (3) START/PAUSE button. Insert the laundry and press the button (3) START/PAUSE.



### **HOT SURFACE!**

**When loading the laundry, make sure you do not burn yourself when you open the dryer door.**

Drying time may be extended.

## Saving personal settings

Initial settings may be changed.





When the program and additional functions are selected, you may store such combination by pressing the (3) START/PAUSE key and holding it for 3 seconds. A signal light on the (3) START/PAUSE key and an acoustic signal will confirm your selection. Indication »**saved**« »(saved)« will be appear briefly on the display unit (9).

Press the (3) START/PAUSE button to start the drying process



The changed combination will appear every time you switch on the dryer.

Follow the same procedure to change a previously saved combination.

## Personal settings menu

Switch on the dryer by pressing the (1) **ON/OFF** button. To open the Personal settings menu, simultaneously press on the positions (4) **EXTRA DRY**  (DRYNESS LEVEL) and (7) **ANTICREASE**  (CREASE PREVENTION) and hold them for 3 seconds. The symbols (5) **DELAY END**  (DELAYING THE END OF THE DRYING PROGRAM), (8) **CLEAN THE FILTER**  and (10) **CONDENSATE TANK**  will light up on the display unit.

Number 1 will appear on the LED display, indicating the settings function. Rotate the programme selector knob (2) to the left or to the right to choose the function to change. Number 1 indicates sound settings and number 2 indicates resetting of Personal programme settings to factory defaults. If the desired settings are not selected in 20 seconds, the programme will automatically return to main menu.

Press on the position (5) **DELAY END**  (DELAYING THE END OF THE DRYING PROGRAM) to confirm the desired functions and their relevant settings. Press on the position (4) **EXTRA DRY**  (DRYNESS LEVEL) to go back one step.

Acoustic signal volume can be set at four levels (0 means the sound is off; 1 means that the button sound is activated; 2 means low volume, and 3 means high volume). Choose the volume level by rotating the programme selector knob (2) to the left or to the right. The lowest setting means that the acoustic signal is switched off.

# CLEANING AND MAINTENANCE



## ELECTRIC SHOCK!

Before cleaning, make sure to switch off the dryer and disconnect it from the power mains (unplug the power cord from the outlet).

The dryer is fitted with a **filtering system** consisting of one filter.

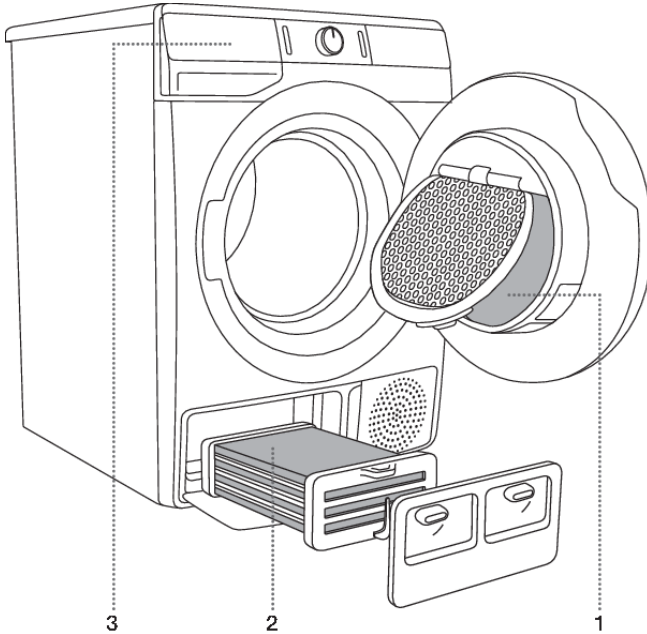

- 1** Net filter
- 2** Water condenser unit
- 3** Condensate tank



## INFORMATION!

The dryer may never be operated without the filter in place, or with damaged filter, as excessive amount of accumulated fibres from the fabric could cause malfunction or failure of the dryer.

## Cleaning the door net filter in the door



### INFORMATION!

Clean the net filter after each drying cycle.

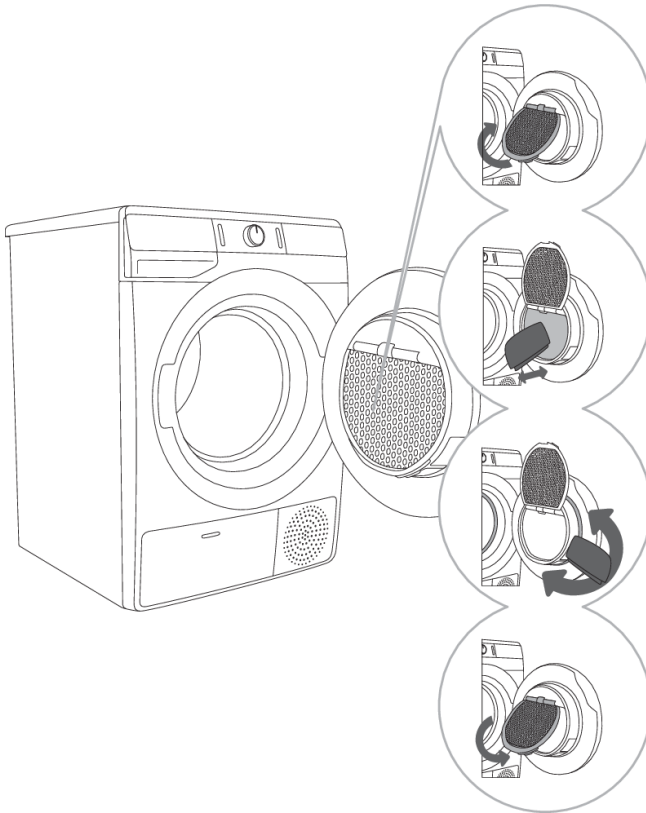

**1** Lift the filter cover.

**2** Gently scrape the filter to remove the lint, i.e. the lining of fibres and threads, with your hand or with a cloth.

**3** If necessary, clean the filter housing and door gasket as well.

**4** Close the filter cover.



### INFORMATION!

Make sure you do not pinch your fingers with the filter cover.

## Cleaning of water condenser



### INFORMATION!

During cleaning, some water may be spilled. It is therefore recommended to place an absorbent cloth on the floor.



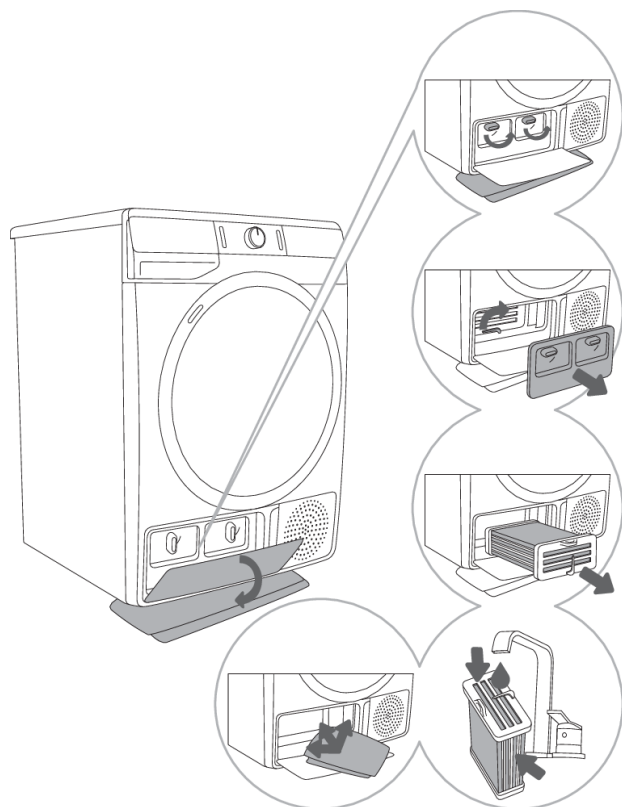

**1** Open the outer cover. Hold the levers on the inside cover and rotate them upwards.

**2** Remove the inside cover. Rotate the condenser unit lever up.

**3** Use the handle to pull out the condenser unit.

**4,5** Rinse the inside of the condenser unit with running water on both sides; drain it thoroughly and replace it. Use a soft damp cloth to clean the space behind the condenser unit (reach deep into the opening as far as the back wall with your hand); then, clean all gaskets and sealing surfaces on the condenser unit housing and door.

 **INFORMATION!**

Do not poke into the openings between the condenser unit ribs as this may damage the condenser unit.

 **INFORMATION!**

Do not wash the condenser unit in a dishwasher.

## Emptying the condensate tank

 **INFORMATION!**

Empty the condensate tank after each drying cycle.

If the condensate tank is full, the drying programme will be paused automatically.

Symbol  (10) will light up on the display unit, indicating that the condensate tank should be emptied.

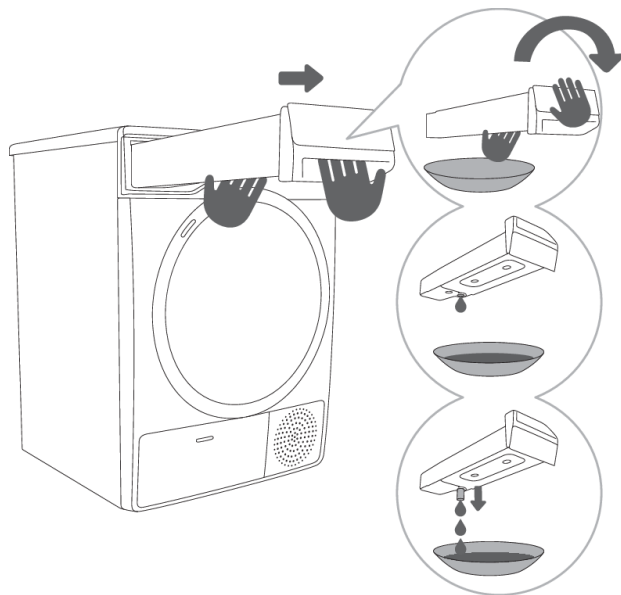

**1** Pull out the condensate tank from the dryer (using both hands as shown in the figure), then turn it upside down over a washbasin, sink, or any suitable vessel.

**2,3** Empty the condensate tank. When emptying the tank, pull out the spout that simplifies pouring the water from the tank, and be careful to avoid burns as the water may be hot. Replace the condensate tank. Replace the condensate tank.



**INFORMATION!**

Water from the condensate tank is not drinkable. If thoroughly filtered, it can be used for ironing.



**WARNING!**

Never add chemicals or fragrances into the condensate tank.

It is not necessary to empty the condensate tank if the drain hose is connected directly to a drain (see chapter »INSTALLATION AND CONNECTION/Draining the condensate«).

# Cleaning the dryer



## **ELECTRIC SHOCK!**

**Always disconnect the dryer from the power mains before cleaning.**

Clean the dryer exterior using a soft damp cotton cloth.



## **WARNING!**

Do not use any solvents or cleaning agents that could damage the dryer (please observe the recommendations and warnings provided by the manufacturers of the cleaning agents).

Wipe all parts of the dryer with a soft cloth until dry.



## **INFORMATION!**

Do not clean the dryer with a jet of water!

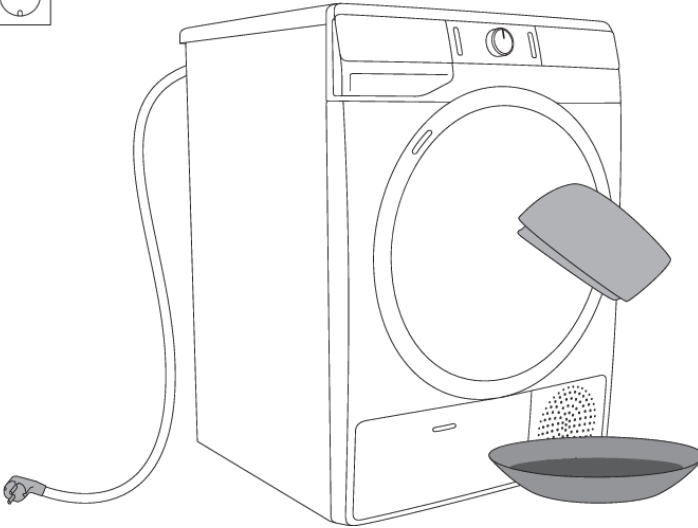

# TROUBLE-SHOOTING

## What to do ...?

Disturbances from the environment (e.g. the power grid) may result in various error reports (see TROUBLESHOOTING TABLE). In such case:

- Switch off the dryer and wait at least one minute.
- Switch on the dryer and repeat the drying programme.
- Most errors during operation can be resolved by the user (see TROUBLESHOOTING TABLE).
- If the error occurs again, call an authorized service unit.
- Repairs may only be carried out by an adequately trained person.
- Repair or any warranty claim resulting from incorrect connection or use of the dryer shall not be covered by the warranty. In such cases, the costs of repair shall be charged to the user.

## Troubleshooting and error table

Problem/Error	Cause	What to do?
<b>The machine will not start.</b>	<ul style="list-style-type: none"> <li>• The main switch is not switched on.</li> </ul>	<ul style="list-style-type: none"> <li>• Check whether the main switch is on.</li> </ul>
	<ul style="list-style-type: none"> <li>• There is no voltage in the power outlet.</li> </ul>	<ul style="list-style-type: none"> <li>• Check the fuse.</li> <li>• Check if the power cord plug is correctly inserted into the power outlet.</li> </ul>
<b>There is voltage in the outlet, but the drum does not spin and the appliance does not work.</b>	<ul style="list-style-type: none"> <li>• Open door.</li> </ul>	<ul style="list-style-type: none"> <li>• Check if the door is closed properly.</li> </ul>
	<ul style="list-style-type: none"> <li>• The condensate tank is full.</li> </ul>	<ul style="list-style-type: none"> <li>• Empty the condensate tank (see chapter »CLEANING AND MAINTENANCE/Emptying the condensate tank«).</li> </ul>
	<ul style="list-style-type: none"> <li>• Perhaps the <b>DELAY END</b> (DELAYING THE END OF THE DRYING PROGRAM) function was set.</li> <li>• Program was not started in accordance with the instructions.</li> </ul>	<ul style="list-style-type: none"> <li>• To cancel the start delay, press on the position (5) <b>DELAY END</b> (DELAYING THE END OF THE DRYING PROGRAM) and hold for 3 seconds.</li> <li>• Re-read the instructions for use again.</li> </ul>
<b>The appliance stops heating completely during a programme.</b>	<ul style="list-style-type: none"> <li>• The net filter may be clogged. As a result, the temperature in the dryer rises, which in turn causes overheating, and therefore heating is switched off.</li> </ul>	<ul style="list-style-type: none"> <li>• Clean the net filter (see chapter »CLEANING AND MAINTENANCE/Cleaning the net filter in the door«).</li> <li>• Wait for the appliance to cool down, and try running it again. If the dryer still fails to start, call a service technician.</li> </ul>







Table continued from last page

<b>Problem/Error</b>	<b>Cause</b>	<b>What to do?</b>
<b>A slight hitting noise appears.</b>	<ul style="list-style-type: none"> <li>• If the dryer is out of use for a long period of time, the support elements are under stress at the same point.</li> </ul>	<ul style="list-style-type: none"> <li>• The noise will subside without any intervention.</li> </ul>
<b>The door opens during drying.</b>	<ul style="list-style-type: none"> <li>• Excessive load on the door (too much laundry in the drum).</li> </ul>	<ul style="list-style-type: none"> <li>• Reduce the amount of laundry.</li> </ul>
<b>Unevenly dried laundry.</b>	<ul style="list-style-type: none"> <li>• Laundry of varying types and thickness, or excessive amount of laundry.</li> </ul>	<ul style="list-style-type: none"> <li>• Make sure you have sorted the laundry by type and thickness, whether you have added a suitable amount of laundry to the drum, and whether you have selected a suitable programme (see PROGRAMME TABLE).</li> </ul>
<b>Laundry not dried or drying takes too long</b>	<ul style="list-style-type: none"> <li>• Filter is not cleaned.</li> </ul>	<ul style="list-style-type: none"> <li>• Clean the filter (see chapter »CLEANING AND MAINTENANCE/Cleaning the net filter in the door«).</li> </ul>
	<ul style="list-style-type: none"> <li>• Dryer is placed in a closed room; room that is too cold; or room that is too small and the air overheats as a result.</li> </ul>	<ul style="list-style-type: none"> <li>• Make sure there is adequate supply of fresh air to the dryer; for example, open the door and/or window.</li> <li>• Check if the temperature in the room where the dryer is installed is too high or too low.</li> </ul>
	<ul style="list-style-type: none"> <li>• Laundry was not sufficiently wrung or spun.</li> </ul>	<ul style="list-style-type: none"> <li>• If the laundry is still wet after the drying cycle, repeat the drying and select an appropriate drying programme (after cleaning the filter).</li> </ul>
	<ul style="list-style-type: none"> <li>• Amount of laundry dried in the appliance is too large or insufficient.</li> </ul>	<ul style="list-style-type: none"> <li>• Use a suitable program or extra functions.</li> </ul>
	<ul style="list-style-type: none"> <li>• Laundry (such as bedding) gets tangled into large balls.</li> </ul>	<ul style="list-style-type: none"> <li>• Close the buttons or zippers on the laundry before drying. Select a suitable programme (e.g. the program Bedding).</li> <li>• After the drying process, loosen the laundry and select an additional drying programme (e.g. Time dry (Timed program)).</li> </ul>
<b>Drum lighting error</b>	<ul style="list-style-type: none"> <li>• There is no lighting when the dryer door is opened.</li> </ul>	<ul style="list-style-type: none"> <li>• Disconnect the dryer from the power mains and call an authorized service unit.</li> </ul>







Table continued from last page

Problem/Error	Cause	What to do?
(depending on the model)		

Errors indicated on the display unit may include the following:

Problem/Error	Indication on the display unit and description of error	What to do?
	<b>Control unit failure</b>	Call service centre.
	<b>Temperature sensor failure</b>	Call service centre.
	<b>Communication error</b>	Call service centre.
	<b>Pump error</b>	Call service centre.
	<b>System overheating</b>	Clean the filter. See chapter »CLEANING AND MAINTENANCE/Cleaning the net filter in the door« or call a service technician.
 	<b>Control unit failure</b>	Disconnect the tumble dryer from the power supply. Call service centre.

Warnings indicated on the display unit may include the following:

Warning	Indication on the display unit and description of warning	What to do?
	<b>Condensate tank warning</b>	Empty the condensate tank before resuming the programme (see chapter »CLEANING AND MAINTENANCE/Emptying the condensate tank«).
	<b>Power supply failure warning</b>	Drying interrupted due to power supply failure. Press the (3) START/PAUSE button to restart or resume the drying programme.
	At the end of the drying programme,  (End) will appear on the display unit. Two red symbols  and  will light up. This is not a fault; it is just a warning that the filters need to be cleaned after drying.	Clean the filters and empty the condensate tank.

Write down the error code (e.g. E0, E1), switch off the dryer, and call the nearest authorized service (call centre).

## Sounds



### **INFORMATION!**

In the initial drying stage, the heat pump causes noise; this, however, does not affect the tumble dryer operation.

**Pumping or liquid flowing sound:** the pump is pumping the condensate into the condensate tank.

**Rumbling or rattling noise:** during drying when the laundry also includes hard parts (such as buttons, zippers etc.).

# Service

## Before calling a service technician

When you contact a service centre, please state your dryer's type (1), code/ID (2), model number (3), and serial number (4).

Dryer type, code, model, and serial number can be found on the rating (type) plate on the inner side of the dryer door.

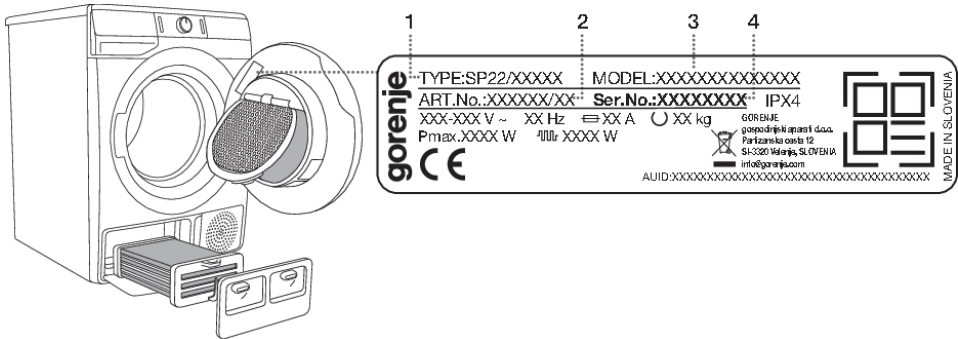

### **WARNING!**

In case of a failure, only use approved spare parts by authorized manufacturers.



### **WARNING!**

Repair or any warranty claim resulting from incorrect connection or use of the dryer shall not be covered by the warranty. In such cases, the costs of repair shall be charged to the user.



### **INFORMATION!**

The warranty does not cover the errors or failures resulting from disturbances from the environment (lightning strike, power grid failures, natural disasters etc.).

**Additional equipment and accessories for maintenance can be viewed on our website at:**  
**[www.gorenje.com](http://www.gorenje.com)**



# TIPS FOR DRYING AND ECONOMIC USE YOUR DRYER

The most economical way of drying is to dry the recommended amount of laundry in each batch (see PROGRAMME TABLE).

Drying laundry made of particularly delicate fabrics that may be deformed is not recommended.

Use of conditioner in the washing cycle is not necessary as the laundry is soft and smooth after drying in the dryer. Drying time will be shorter and power consumption will be lower if the garments are thoroughly wrung or spun before drying. By selecting the appropriate drying programme, you will avoid over-drying your laundry and problems with ironing or shrinkage of fabric.

Regular cleaning of the filters will lead to optimum drying time and minimum power consumption.

When drying smaller amounts of laundry or individual garments, the sensor may not perceive the actual level of moisture in the laundry. In such cases, it is recommended to dry smaller items or amounts with programmes for dryer laundry or with the timed programme.

# TYPICAL CONSUMPTION TABLE

The table lists the values for drying time and power consumption for drying of a test batch of laundry with various spinning rpm in the washing machine.

## 7 kg

Program	Load	Spinning [rpm]	Electric energy consumption [kWh]	Drying time [min]
			7 kg	
Cotton Standard	Total	1000	4,24	125
	Partial	1400	2,35	85
	Low	1000	2,30	79
	Low	1400	2,12	68
Cotton moist for ironing	Total	1000	3,26	110
	Partial	1400	2,25	80
	Low	1400	2,05	72
Synthetics	Partial	1000	1,50	60

## 8 kg

Program	Load	Spinning [rpm]	Electric energy consumption [kWh]	Drying time [min]
			8 kg	
Cotton Standard	Total	1000	4,74	150
	Partial	1400	2,60	99
	Low	1000	2,55	95
	Low	1400	2,23	85
Cotton moist for ironing	Total	1000	3,75	120
	Partial	1400	2,45	88
	Low	1400	2,15	79
Synthetics	Partial	1000	1,50	60

Program	Amount of laundry max./half load [kg]	Programme duration [min.]	Electric energy consumption [kWh]
Cotton Standard ☐	7/3,5	125/79	4,25/2,30
Cotton Standard ☐	8/4	150/95	4,74/2,55

Standard programmes for cotton laundry in compliance with the currently effective regulation EU 392/2012

The Cotton Standard programme  $\square$ , is intended for drying of normally wet cotton laundry. It is the most efficient programme for drying cotton laundry in terms of power consumption.

Due to deviations in terms of type and amount of laundry, power supply oscillation, and environment temperature and humidity, the values measured at the end user may differ from the one stated in the table.

## Low standby mode

If you do not run a programme or do anything else after switching on the dryer, the dryer will switch off automatically after 5 minutes to save energy. Indicator light on the (3) START/PAUSE button will flash.

The display will be reactivated if you rotate the programme selector knob or press the (1) ON/OFF button or open the dryer door. If you do not do anything for 5 minutes after the end of the programme, the display unit will be switched off as well. Indicator light on the (3) START/PAUSE button will flash.

$P_o$ = weighted power when off [W]	< 0,5
$P_I$ = weighted power when in standby [W]	< 0,5
$T_I$ = standby time [min]	5,00



### INFORMATION!

Low mains voltage and different drying loads may affect the drying time; the remaining time displayed is adjusted accordingly during the drying process.

# PRODUCT ENERGY LABEL AND PRODUCT FICHE

(depending on the model)



## ENERG

енергия · ενεργεια

Y

IJA

IE

IA

XXXXXX

<b>A+++</b>	
<b>A++</b>	
<b>A+</b>	
<b>A</b>	<b>X</b>
<b>B</b>	
<b>C</b>	
<b>D</b>	

ENERGIA · ЕНЕРГИЯ · ΕΝΕΡΓΕΙΑ  
ENERGIJA · ENERGY · ENERGIE  
ENERGI

## XXX

kWh/annum



XXX

min/cycle\*



X

kg



XX

dB



XXXXXXXX

\*цикъл · cyklus · portion · zyklus  
 програма · ciclo · tsükkel  
 ohjelma · ciklus · ciklas · cikls  
 ciklu · cyclus · cykl · ciclu  
 program · torkomgång

392/2012

**PRODUCT FICHE according to EU-Regulation No. 392/2012**

(depending on model)

## Legend

<b>A</b>	<b>Model</b>	XXXXXX
<b>B</b>	Condenser tumble dryer Vented tumble dryer	YES=YES; NO=NO YES=YES; NO=NO
<b>C</b>	Automatic tumble dryer	YES=YES; NO=NO
<b>D</b>	»EU Ecolabel«, Regulation EC 66/2010	YES=YES; NO=NO
<b>E</b>	Energy consumption of the standard cotton programme at full load ( $E_{dry}$ ) [kWh]	X,XX
<b>F</b>	Energy consumption of the standard cotton programme at partial load ( $E_{dry1/2}$ ) [kWh]	X,XX
<b>G</b>	Power consumption of the off-mode ( $P_o$ ) [W]	X,XX
<b>H</b>	Power consumption of the left-on mode ( $P_l$ ) [W]	X,XX
<b>I</b>	The duration of the left-on mode [min]	XX
<b>J</b>	Standard cotton programme, used at full and partial load is the standard drying programme to which the information in the label and the fiche relates. Cotton Standard □ program is intended for drying of normally wet cotton laundry. In terms of total energy consumption, it is the most efficient program for drying cotton laundry.	
<b>K</b>	Weighted programme time ( $T_t$ ) of the standard cotton programme at full and partial load [min]	XX
<b>L</b>	Programme time of the standard cotton programme at full load ( $T_{dry}$ ) and partial load ( $T_{dry1/2}$ ) [min]	XX/XX
<b>M</b>	Average condensation efficiency ( $C_{dry}$ ) / ( $C_{dry1/2}$ )	XX/XX
<b>N</b>	Weighted condensation efficiency ( $C_t$ )	XX
<b>O</b>	Built-in appliance	YES=YES; NO=NO

Based on 160 standard drying cycles with the Cotton Standard (Cotton Standard) □ program at full and half load, pursuant to the currently effective Regulation 392/2012/EU on energy labelling of household tumble driers, measured according to EN 61121.

Actual power consumption will depend on the way the appliance is used.

On a scale from D (the least efficient) to A+++ (the most efficient).

# DISPOSAL



**Packaging** is made of environmentally friendly materials that can be recycled, disposed of, or destroyed without any hazard to the environment. To this end, packaging materials are labelled appropriately.

**The symbol** on the product or its packaging indicates that the product should not be treated as normal household waste. Take the product to an authorized collection centre for waste electric and electronic equipment processing.

When **disposing** of the appliance at the end of its useful life, remove all power cords, and destroy the door latch and switch to prevent the door from locking or latching (child safety).

Correct **disposal** of the product will help prevent any negative effects on the environment and health of people, which could occur in case of incorrect product removal. For detailed information on removal and processing of the product, please contact the relevant municipal body in charge of waste management, your waste disposal service, or the store where you bought the product.

# **gorenje**

GORENJE gospodinjski aparati, d.o.o. Address: Partizanska 12, 3320 Velenje, Slovenia  
Phone: +386 (0)3 899 10 00 Fax: +386 (0)3 899 28 00 [www.gorenje.com](http://www.gorenje.com)



864091-a3



*We reserve the right to any changes and errors in the instructions for use.*