

**Hisense**

life reimagined

EN

GB

IE

# **INSTRUCTIONS FOR USE OF A BUILT-IN OVEN**

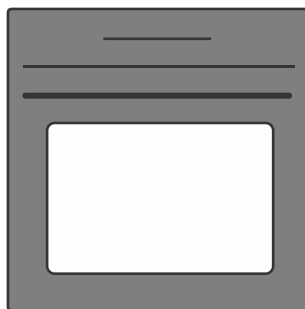

We thank you for your trust and the purchase of our appliance.

This detailed instruction manual is supplied to make the use of this product easier. The instructions should allow you to learn about your new appliance as quickly as possible.

Make sure you have received an undamaged appliance. If you do find transport damage, please contact the seller from which you purchased the appliance, or the regional warehouse from which it was supplied. The telephone number can be found on the invoice or on the delivery note.

Instructions for installation and connection are supplied on a separate sheet.

The following symbols are used throughout the manual and they have the following meanings:



**INFORMATION!**

Information, advice, tip, or recommendation



**WARNING!**

Warning – general danger



It is important that you carefully read the instructions.

# Contents

<b>Safety precautions</b> .....	<b>4</b>
<b>Other important safety warnings</b> .....	<b>5</b>
<b>Appliance description</b> .....	<b>7</b>
Rating plate – product information .....	7
Control unit .....	8
Push-pull knobs .....	8
<b>Appliance equipment</b> .....	<b>9</b>
Guides .....	9
Oven door switch .....	10
Cooling fan .....	10
Oven equipment and accessories .....	10
<b>Before first use</b> .....	<b>12</b>
<b>Switching on for the first time</b> .....	<b>12</b>
<b>Choosing the settings</b> .....	<b>13</b>
CHOOSING THE COOKING SYSTEM .....	13
SETTING THE COOKING TEMPERATURE .....	14
TIME FUNCTION .....	15
<b>Starting the cooking process</b> .....	<b>17</b>
<b>End of cooking by touching</b> .....	<b>17</b>
<b>General settings</b> .....	<b>18</b>
<b>General tips and advice for baking</b> .....	<b>20</b>
<b>Cooking table</b> .....	<b>21</b>
<b>Cooking with a temperature probe</b> .....	<b>25</b>
Recommended doneness levels for different types of meat .....	26
<b>Cleaning and maintenance</b> .....	<b>27</b>
Using the Steam Clean program to clean the oven .....	28
Removing wire and fixed pull-out (extendible) guides .....	29
Removing and replacing the oven door and glass panes .....	30
Replacing the bulb .....	31
<b>Troubleshooting table</b> .....	<b>32</b>
Special warnings and fault reporting .....	32
<b>Disposal</b> .....	<b>33</b>
<b>Cooking test</b> .....	<b>34</b>

## **Safety precautions**

### **IMPORTANT SAFETY PRECAUTIONS – CAREFULLY READ THE INSTRUCTIONS AND SAVE THEM FOR FUTURE REFERENCE.**

Appliance must be connected to fixed wiring which has incorporated means of disconnection. Fixed wiring must be made in accordance with the wiring rules.

Means for disconnection must be incorporated in the fixed wiring in accordance with the wiring rules.

The appliance must not be installed behind a decorative door in order to avoid overheating.

If the supply cord is damaged, it must be replaced by the manufacturer, its service agent or similarly qualified persons in order to avoid a hazard (only for appliances supplied with connection cord).

This appliance can be used by children aged 8 years and above, and by persons with reduced physical, sensory or mental capabilities or lack of experience and knowledge, if they have been given supervision or instruction concerning the use of the appliance in a safe way, and if they understand the hazards involved. Children shall not play with the appliance. Cleaning and user maintenance shall not be done by children without supervision.

**WARNING:** Accessible parts may become hot during use. Young children should be kept away.

**WARNING:** The appliance and some of its accessible parts may become very hot during use. Care should be taken to avoid touching heating elements. Children less than 8 years of age shall be kept away unless continuously supervised.

The appliance is not intended to be controlled by external timers or separate remote control system.

Only use the temperature probe recommended for use in this oven.

Do not use harsh abrasive cleaners or sharp metal scrapers to clean the oven door glass/ the glass of hinged lids of the hob (as appropriate), since they can scratch the surface, which may result in shattering of the glass.

Do not use steam cleaners or high-pressure cleaners to clean the appliance as this may result in an electric shock.

**WARNING:** Before replacing the light bulb, make sure the appliance has been disconnected from the mains power, in order to prevent the hazard of an electric shock.

Never pour water directly on the bottom of the oven cavity. Temperature differences could result in damage to the enamel coating.

## **Other important safety warnings**

The appliance is intended for household use. Do not use it for any other purpose, such as room heating, drying of pets or other animals, paper, fabrics, herbs etc. As this may lead to injury or fire hazard.

Appliance must be connected to fixed wiring which has incorporated means of disconnection. Fixed wiring must be made in accordance with the wiring rules.

We recommend that (due to appliance weight) at least two persons carry and install the appliance.

Do not lift the appliance by holding it by the door handle.

Oven door hinges may be damaged when under excessive load. Do not stand or sit on the open oven door, and do not lean against it. Also, do not place any heavy objects onto the oven door.

If the power cords of other appliances placed near this appliance get entangled in the oven door, they can be damaged, which in turn can result in a short circuit. Therefore, make sure the power cords of other appliances are always at a safe distance.

Make sure the vents are never covered or obstructed in any other way.

Do not line the oven cavity with aluminium foil, and do not place any baking trays or other cookware on the oven bottom. This would obstruct and reduce air circulation in the oven, slow down the baking process, and destroy the enamel coating.

We recommend you avoid opening the oven door during baking, as this increases power consumption and increases condensate accumulation.

At the end of the baking process, and during baking, be careful when opening the oven door, as there is danger of scalding.

To prevent limescale accumulation, leave the oven door open after baking or using the oven, to allow the oven cavity to cool down to room temperature.

Clean the oven when it has completely cooled down.

Eventual mismatches in colour shades between different appliances or components within a single design line may occur due to various factors, such as different angles under which the appliances are observed, different coloured backgrounds, materials, and room illumination.

Do not use the appliance if it is damaged. Unplug the appliance from the power mains and call an authorized service centre.

The oven can be safely used with or without baking pan guides.

Do not store items in the oven, which could cause danger when the oven is switched on.

The deviation of the daily time display on the screen does not affect the functionality of the appliance and may be due to fluctuations in the frequency of the electrical network.



**WARNING!**

**Carefully read the instructions for use before connecting the appliance. Repair or any warranty claim resulting from incorrect connection or use of the appliance shall not be covered by the warranty.**

# Appliance description



## INFORMATION!

Appliance functions and equipment depend on the model.

Basic equipment of your appliance includes wire guides, shallow baking tray, and a wire rack.

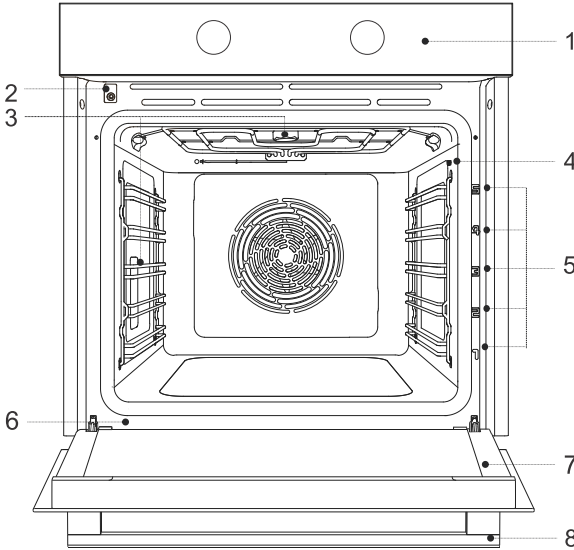

- |                             |                      |
|-----------------------------|----------------------|
| 1. Control unit             | 5. Rack levels (1–5) |
| 2. Door switch              | 6. Rating plate      |
| 3. Lighting                 | 7. Oven door         |
| 4. Temperature probe socket | 8. Door handle       |

## Rating plate – product information

A rating plate with basic information about the appliance is attached to the edge of the oven.

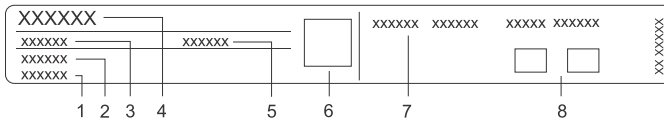

- |                  |                                     |
|------------------|-------------------------------------|
| 1. Serial number | 5. ID/code                          |
| 2. Model         | 6. QR code (depending on the model) |
| 3. Type          | 7. Technical information            |
| 4. Brand         | 8. Compliance labels/symbols        |

# Control unit

(depending on the model)

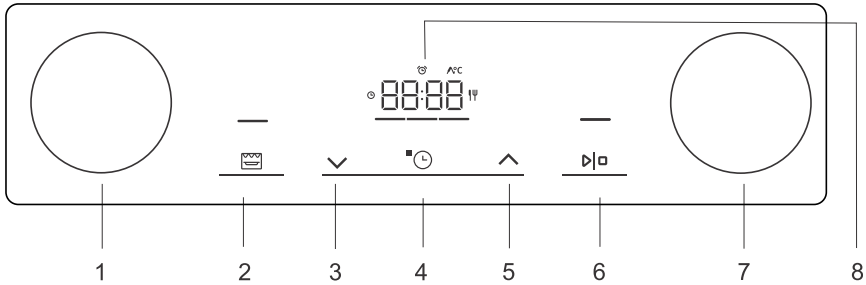

1. System selector knob
2. Gratin, cancel or back key
3. Value decrease key
4. Timer function and settings key
5. Value increase key
6. start | stop key for confirming, starting, or stopping/pausing
7. Temperature settings knob
8. Display



## INFORMATION!

For better key response, touch the keys with a larger area of your fingertip. Each time you press a key, this will be acknowledged by a short acoustic signal.

# Push-pull knobs

(depending on the model)

Slightly push the knob until it pops out; then, rotate it.



## WARNING!

After each use, rotate the knob back to the "off" position and push it back in. The push-pull knob can only be pushed back when the switch is in the "off" position.



# Appliance equipment

## Guides

- The guides allow cooking or baking on 5 rack levels.
- The height levels of guides into which the racks can be inserted shall be counted from bottom up.
- Guide levels 4 and 5 are intended for grilling/broiling.
- When inserting equipment, it should be correctly rotated.

## Wire guides

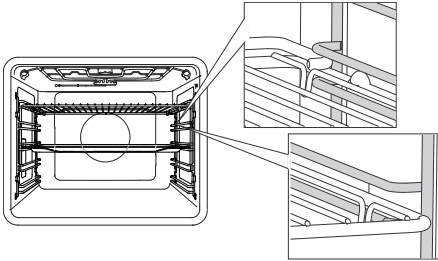

In case of wire guides, always insert the wire rack and the baking tray into the slot between the upper and lower part of each guide level.

## Fixed pull-out guides

(depending on the model)

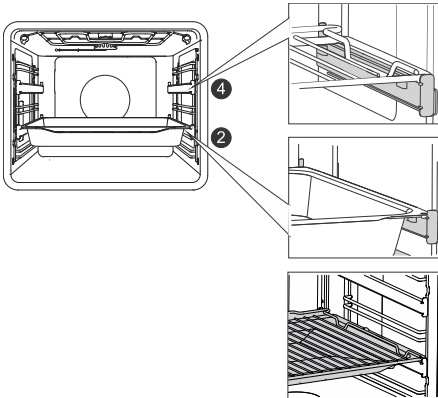

Pull-out guides may be fitted for the 2nd and 4th level.

In case of fixed pull-out guides, place the rack or baking tray onto the guide. You can place the wire rack directly onto a baking tray (shallow or deep all-purpose baking tray) and place both onto the same guide; in this case, the baking tray acts as a drip tray.

## Click-on pull-out guides

(depending on the model)



The click-on pull-out guide can be inserted into any space between two wire guides.

Place the guide symmetrically onto the wire guides on the left and the right side of the oven cavity. First, hook the upper clip of the guide under the wire of the wire guide. Then, press the lower clip into the right position until you hear a **CLICK**.

**NOTE:** The guides can be attached to any height between two levels of wire guides.

### **INFORMATION!**

The click-on pull-out guides cannot be mounted onto guides with fixed double-level partial extension. They can, however, be mounted on to single-level partially extendible guides, to levels 3-4 and 4-5.

Make sure the pull-out guide is correctly rotated and that it extends outwards, i.e. out from the oven.

## Oven door switch

(depending on the model)

If the oven door is opened during oven operation, the switch turns off the heater and fan in the oven cavity. When the door is closed, the switch turns the appliance operation back on.

## Cooling fan

The appliance is fitted with a cooling fan that cools the housing, the door, and the appliance control unit. After the oven is switched off, the cooling fan continues to operate for a short while in order to cool down the oven.

## Oven equipment and accessories

(depending on the model)



The **WIRE RACK** is used for grilling/broiling or as support for a pan, baking tray or baking dish with the food you are baking.

### **INFORMATION!**

There is a safety latch on the wire rack. Therefore, the wire rack has to be lifted slightly at the front when pulling it out from the oven.



**SHALLOW BAKING TRAY** is used for flat and small pastry. It can also be used as a drip tray.



**WARNING!**

The shallow baking tray may deform as it heats up in the oven. Once it cools down, it returns to the initial shape. Such deformation does not affect its function.

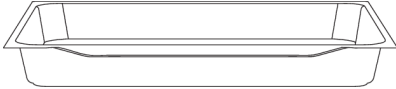

The **ALL-AROUND DEEP BAKING TRAY** is used for roasting vegetables and baking moist pastry. It can also be used as a drip tray.



**INFORMATION!**

Never insert the all-purpose (or universal) deep baking tray into the first guide during baking.



Temperature **PROBE (BAKESENSOR)**.



**WARNING!**

The appliance and some of the accessible parts tend to heat up during cooking.

# Before first use

- Remove oven accessories and any packaging (cardboard, polystyrene foam) from the oven.
- Wipe the oven accessories and interior with a damp cloth. Do not use abrasive or aggressive cloths or cleaners.
- Heat an empty oven for approximately one hour with the top and bottom heater system at a temperature of 250 °C. The characteristic "new oven scent" will be released; therefore, ventilate the room thoroughly during this process.

# Switching on for the first time

After connecting your appliance to the power mains or after an extended power outage, 12:00 will appear on the display.

First, choose and confirm the basic settings.



## INFORMATION!

You can change them by touching the keys  $\vee$  or  $\wedge$ . Confirm the desired setting by pressing  $\triangleright|$ . You can set the next setting when you have already set and confirmed the previous one.

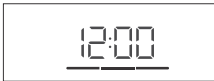

### 1. SETTING THE TIME

By touching the keys  $\vee$  or  $\wedge$  you can set the time of day. If you hold down the value setting key longer, the values change faster.



## INFORMATION!

To set or adjust the clock later on, see chapter Extra functions.

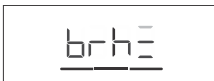

### 2. DISPLAY DIMMER

High light intensity is the default setting. The sign **brh** and the currently set value for the display light intensity will appear on the display unit. Touch the  $\vee$  or  $\wedge$  key to select the desired level, and confirm. Use the value setting keys to increase or decrease light intensity.



### 3. ACOUSTIC SIGNAL VOLUME

Medium volume is the default setting. The sign **Vol** and the currently set value for the acoustic signal volume will appear on the display unit. Touch the  $\vee$  or  $\wedge$  key to select the desired level, and confirm. Acoustic signals can also be switched off.

When the selected settings are confirmed, the clock will appear on the display unit (if the operating system selection KNOB is in position 0).

# Choosing the settings

## CHOOSING THE COOKING SYSTEM

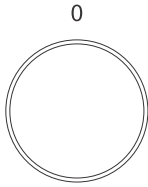

Rotate the KNOB (left and right) to select the COOKING SYSTEM (see program table).







### INFORMATION!

Appliance functions and equipment depend on the model.

Symbol	Use
	<b>QUICK PREHEATING OF THE OVEN</b> To reach the set temperature as quickly as possible. When the oven is preheated to the set temperature, a short beep will sound and the dash below the clock will light up. Then you can select the system setting you want to use to prepare the food. This function is not suitable for baking.
	<b>TOP AND BOTTOM HEATER WITH FAN<sup>1)</sup></b> For even baking of food on a single rack, and for making soufflés.
	<b>TOP AND BOTTOM HEATER<sup>1)</sup></b> Use this system for conventional baking on a single rack, making soufflés, and baking at low temperatures (slow cooking).
	<b>LARGE GRILL WITH FAN<sup>1)</sup></b> For roasting poultry and larger cuts of meat under the broiler.
	<b>PIZZA SYSTEM<sup>1)</sup></b> This system is optimal for baking pizza and pastry with higher water content. Use it to bake on a single rack when you want the food to be done faster and to be crunchy.
	<b>LARGE GRILL<sup>1)</sup></b> Use this system to grill large amounts of flat-shaped food like toast, open sandwiches, grill sausages, fish, skewers etc., as well as for cooking au gratin and for browning the crust. The heaters mounted on the top of the oven cavity evenly heat the entire surface. Maximum allowed temperature is 240 °C.
	<b>SLOW BAKING<sup>2)</sup></b> For gentle, slow and even cooking of meat, fish and pastry on a single rack. This cooking method will leave the meat with a higher water content, making it juicier and more tender, while pastry will be evenly browned/baked. This system is used in the temperature range between 140 °C and 220 °C.
	<b>BAKING FROZEN FOOD<sup>1)</sup></b> This method allows baking frozen food in a shorter period of time without pre-heating. Optimum for pre-baked frozen products (bakery products, croissants, lasagne, French fries, chicken nuggets), meat and vegetables.

Table continued from last page

Symbol	Use
	<b>DEFROSTING</b> Use this function for controlled defrosting of frozen food (cakes, pastry, bread, rolls, and deep-frozen fruit). During the defrosting process, turn the pieces of food over, stir the food, and separate any chunks that are frozen together. For microbiological safety, we recommend slowly defrosting meat and other delicate foods in the refrigerator.
	<b>STEAM CLEAN</b> This program makes it easier to remove any stains from inside the oven.
	<b>OVEN LIGHT</b> Oven light is switched on when a system is selected or when the knob is turned to the light position.

-  In these systems, it is possible to use the gratin function (see chapter Starting the cooking process).
- This function is used for determining the energy efficiency class pursuant to the EN 60350-1 standard.

## SETTING THE COOKING TEMPERATURE

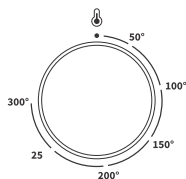

Rotate the knob to set the desired TEMPERATURE.

# TIME FUNCTION

First, rotate the KNOB to set the SYSTEM and TEMPERATURE.

		Setting cooking
		Setting delayed end
		Setting the minute minder

## INFORMATION!

During the last 10 minutes before the expiry of the set time, the remaining time is displayed in one-second intervals.



### Setting the cooking time

In this mode, you can specify the duration of oven operation (cooking time).

By pressing  $\vee$  or  $\wedge$  you can set the desired cooking time. To start the oven, touch  $\triangleright|\square$ .



### Setting delayed end

## INFORMATION!

Delayed start cannot be set for the grill and grill with fan systems.

Use this function when you wish to start cooking the food in the oven after a certain period of time. Place the food into the oven, then set the system and temperature. Then, set the program duration and the time when you wish your food done.

Example:

Current time: noon

Cooking time: 2 hours

End of cooking: 6 pm

By pressing  $\vee$  or  $\wedge$  you can set the duration of the programme (in our case this is 2.00). By double-tapping the  $\text{=}\text{⌚}$  key, you can select the time at which you want your food to be ready (in our case this is at 18.00). Confirm your selection. The desired end time is shown on the display (18.00).

To start the oven, touch  $\triangleright|\square$ .

While waiting to start operation, the oven is in a partial standby mode. The display is dimmed, and the fan system and oven lighting are on the entire time. The oven will switch on with the selected settings automatically (in our case at 16:00, or 4 p.m.). The oven will switch off at the set time (in our case, this is 18:00, or 6 p.m.).

## INFORMATION!

Cooking end time and the clock will alternate on the display unit.

After the set time has expired, the oven stops working automatically. The display will show **End**. An acoustic signal will be heard which you may turn off by touching any key. After one minute, the acoustic signal will be switched off automatically.



**WARNING!**



**This function is not suitable for food requiring a preheated oven.**

**Perishable food should not be kept in the oven for a long time.**

**Before using this mode, check whether the clock on the appliance is accurately set.**



**Setting the minute minder**

The minute minder can be used independently of the oven operation. The maximum possible setting is 24 hours. Repeatedly touch the key  until the display shows . By pressing  $\vee$  or  $\wedge$  you can set the duration of the minute minder. When the set cooking time expires, an acoustic signal will be heard which you may turn off by touching any key. After one minute, the acoustic signal will be switched off automatically.



**INFORMATION!**

When setting a timer function, you can reset the value by simultaneously touching the keys  $\vee$  and  $\wedge$ .



# Starting the cooking process



The dash above the key  is now blinking. Start the set programme by touching this key.

While the programme is running, the dash above the key is fully lit.

Until the set temperature is reached, the illuminated dash below the clock moves left and right.

When the set temperature is reached, the display shows °C, an acoustic signal sounds and the dash under the clock becomes fully illuminated.



## INFORMATION!

During the cooking process, you can change the SYSTEM, TEMPERATURE, and TIMER FUNCTIONS.





## INFORMATION!

If no timer function is selected, cooking time will appear on the display unit.



## Extra gratin

The function can only be started after 10 minutes of oven operation (the dash above the gratin key will be partly/dimly lit). When the function is confirmed, cooking time 10 minutes (10:00) will appear on the display unit. Touch the  or  key to set the gratin duration.

The function can also be deactivated by pressing the **gratin** key.

The function is used in the last stage of the cooking process when you add sauce (wet rub) or dry rub onto the food, or when you wish to additionally brown the crust. A golden-brown crust will form on the dish during the gratin process, which protects the food from drying out, while also imparting a more pleasant appearance and better flavour.

# End of cooking by touching

Press the  key to pause the cooking process. **End** appears on display unit and an acoustic signal is emitted.

Rotate the COOKING SYSTEM SELECTOR knob to position "0".



## INFORMATION!

After the use of the oven, some water may be left in the condensate channel (underneath the door). Wipe the channel with a sponge or a cloth.

# General settings

Turn the COOKING SYSTEM SELECTOR KNOB to position "0".

To activate a function, press the  key and hold it for 3 seconds. **SEtt** will appear on the display unit for a few seconds. Then, the extra functions menu will appear.





## INFORMATION!

Use the  or  keys to navigate the menu. Confirm the setting by pressing the  or  key. To exit the extra functions menu, touch the  key.



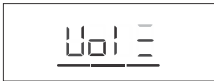

### 1. Clock displayed

Use the  and  keys to set the clock. **CLoc** will appear on the display unit. After you confirm, you can toggle between 12-hour and 24-hour display. Confirm, then set the clock/time of day. First, set and confirm the minutes; then set and confirm the hours.





### 2. Acoustic signal volume

Choose between three beep volume levels. Choose the **Vol** setting. Touch the  or  key to select the desired level, and confirm. Acoustic signals can also be switched off.





### 3. Display illumination

Choose between three levels of display light intensity. Choose the **brh** setting. Touch the  or  key to select the desired level, and confirm. Use the value setting keys to increase or decrease light intensity.



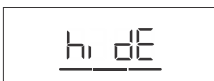

### 4. Display unit – night mode

This function will automatically dim the display (switch from high to the lowest display illumination level) during night time (8:00 p.m. to 6:00 a.m.) Choose the **nGht** setting. Touch the  or  key to select the desired night-time display illumination, and confirm.



### 5. Standby

This function automatically switches the clock display on or off. Select the **hi dE** setting. Touch the  or  key to select on or off, and confirm.



FAcT

### 7. Factory settings

This function allows resetting the appliance to factory settings. **FAcT** will appear on the display unit. Touch the  $\vee$  or  $\wedge$  key to select rES to choose the factory settings, and confirm by pressing and holding the  $\triangleright|\square$  key. Hold the key until all lit dashes disappear.



#### **WARNING!**

**After a power outage or after the appliance is switched off, additional function settings will remain stored for no more than a few minutes. Then, all settings, except for the acoustic signal volume and display dimmer will be reset to factory defaults.**

# General tips and advice for baking

- Remove all unnecessary equipment from the oven during baking
- Use equipment made of heat-resistant non-reflective materials (supplied baking trays and dishes, enamel-coated cookware, tempered glass cookware). Bright-coloured materials (stainless steel or aluminium) materials reflect heat. As a result, thermal processing of food in them is less effective.
- Always insert the baking sheets and trays to the end of the guides. When baking on the wire rack, place the baking dishes or trays in the middle of the rack.
- For optimum food preparation, we recommend observing the guidelines specified in the cooking table. Choose the lower specified temperature and the shortest specified cooking time. When this time expires, check the results and then adjust the settings as necessary.
- Unless it is absolutely necessary, do not open the oven door during baking.
- Do not place the baking trays directly onto the oven cavity bottom.
- Do not use the all-purpose deep baking tray on the 1st guide level while the appliance is operating.
- Do not cover the oven cavity bottom or the wire rack with aluminium foil.
- With longer cooking programs, you can switch off the oven approximately 10 minutes before the end of cooking time to make use of the accumulated heat.
- Always place the baking dishes onto the wire rack.
- When baking on several levels at the same time, insert the all-purpose deep baking tray into the lower level.
- When cooking according to recipes from older cookbooks, use the bottom and top heater system (as in conventional ovens) and set the temperature 10 °C lower than specified in the recipe.
- If you are using parchment paper, make sure it is resistant to high-temperatures. Always trim it accordingly. Parchment paper prevents the food from sticking to the baking tray and makes it easier to remove the food from the baking tray.
- When cooking larger cuts of meat or pastry with higher water content, a lot of steam will be generated inside the oven, which in turn may condense on the oven door. This is a normal phenomenon which will not affect the operation of the appliance. After the cooking process, wipe the door and the door glass dry.
- When baking directly on the wire rack, insert the all-purpose deep tray one level lower to serve as a drip tray.

**Fast preheating of the oven:** Only preheat the oven if required by the recipe of in the tables in these instructions for use. If you are using the fast preheating function, do not insert the food into the oven until the oven is fully heated. Temperature has a substantial effect on the final result. Fast preheating is recommended for delicate cuts of meat (sirloin), and for yeast-leavened and sponge dough that require a shorter baking time. Heating an empty oven consumes a lot of energy. Therefore, if possible, we recommend cooking several dishes in succession, or making several dishes simultaneously.

**Slow Bake:** Allows slow and controlled cooking at a low temperature. The meat juices are distributed evenly, and the meat remains juicy and tender. The SlowBake slow cooking method is suitable for delicate boneless meat cuts. Before slow cooking, sear the meat thoroughly from all sides in a frying pan.

# Cooking table

NOTE: Dishes requiring a fully pre-heated oven are indicated with a single asterisk \* in the table. Dishes for which a 5-minute pre-heating cycle suffices are indicated with two asterisks \*\*. In this case, do not use the rapid preheat mode.























Dish			°C	min
<b>PASTRY AND BAKERY PRODUCTS</b>				
<b>pastry/cakes in moulds</b>				
sponge cake	1		150	45-55
pie with filling	1		180	90-120
marble cake	2		170-180	50-60
cake with leavened dough, Gugelhupf (Bundt cake, pound cake)	2		170-180	45-55
open pie, tart	3		180-190	35-45
brownies	2		180-190	30-35
<b>pastry on baking trays and dishes</b>				
strudel	2		180-200	60-70
strudel, frozen	2		190-210	34-45
sponge roll	3		180-190*	13-18
buchteln	2		180-190	30-40
<b>biscuits, cookies</b>				
cupcakes	3		160 *	20-30
yeast-leavened small pastry	2		180 *	17-22
puff pastry	2		200 *	15-20
<b>cookies/biscuits</b>				
piped cookies	3		140 *	30-40
cookies/biscuits	3		160-170 *	15-20
meringue	3		80-100 *	120-150
macarons	3		130-140 *	15-20
<b>bread</b>				
rising and proofing	2		40-45	30-45
bread on a baking tray	2		190-200	40-55
bread in a tin	1		190-200	30-45
flatbread (focaccia)	2		270	15-25

Table continued from last page





































Dish			°C	min
fresh bread rolls (Semmel/morning rolls)	3		200-210	10-15
toasted bread	5		230	4-7
open sandwiches	5		230	3-5
<b>pizza and other dishes</b>				
homemade pizza	1		300 *	5-10
frozen pizza	2		200-220 *	10-25
savoury pie, quiche	2		180-200	50-60
burek	2		180-190	40-50
<b>MEAT</b>				
<b>beef and veal</b>				
beef roast (loin, rump), 1.5 kg	2		160-170	130-160
boiled beef, 1.5 kg	2		200-210	90-120
sirloin, medium done, 1 kg	2		170-190 *	40-60
beef roast, slow cooked	2		120-140 *	250-300
beef steaks, well done, thickness 4 cm	4		220-230	25-30
burgers, thickness 3 cm	4		220-230	25-35
veal roast, 1.5 kg	2		160-170	120-150
<b>pork</b>				
pork roast, rump, 1.5 kg	3		170-180	100-130
pork roast, shoulder, 1.5 kg	3		180-190	120-150
pork loin, 400 g	2		80-100 *	80-100
pork roast, slow cooked	2		100-120 *	200-230
pork ribs, slow cooked	2		120-140 *	210-240
pork chops, thickness 3 cm	4		220-230	20-25
<b>poultry</b>				
poultry, 1.2–2.0 kg	2		200-220	60-80
poultry with stuffing, 1.5 kg	2		170-180	80-100
poultry, breast	2		170-180	45-60
chicken thighs	3		210-220	30-45
chicken wings	4		210-220	30-45

Table continued from last page

Dish			°C	min
poultry, breast, slow cooked	3		100-120 *	60-90
<b>meat dishes</b>				
meat loaf, 1 kg	2		170-180	60-70
grill sausages, bratwurst	4		230 **	8-15
<b>FISH AND SEAFOOD</b>				
whole fish, 350 g	4		230-240	12-20
fish fillet, thickness 1 cm	4		220-230	8-12
fish steak, thickness 2cm	4		220-230	10-15
scallops	4		230 *	5-10
shrimps	4		230 *	3-10
<b>VEGETABLES</b>				
baked potatoes, wedges	3		210-220 *	30-40
baked potatoes, halved	3		200-210 *	40-50
stuffed potato (jacket potato)	3		190-200	30-40
French fries, home-made	4		210-220 *	20-30
mixed vegetables, wedges	3		190-200	30-40
stuffed vegetables	3		190-200	30-40
<b>CONVENTIONAL PRODUCTS – FROZEN</b>				
French fries	3		210-220	20-30
chicken medallions	4		210-220 *	12-20
fish fingers	2		210-220	15-25
lasagne, 400 g	2		200-220	30-40
diced vegetables	2		190-210	20-30
croissants	3		170-180	18-23
<b>BAKED PUDDINGS, SOUFLÉS AND DISHES AU GRATIN</b>				
potato moussaka	2		180-190	35-45
lasagne	2		190-200	35-45
sweet baked pudding	2		160-180	40-60
sweet soufflé	2		160-180 *	35-45
dishes au gratin	3		170-190	30-45
stuffed tortillas, enchiladas	2		180-200	20-35

Table continued from last page

<b>Dish</b>			 °C	 min
grilling cheese	4		230 **	6-9
<b>OTHER</b>				
preservation	2		180	30
sterilization	3		125	30
cooking in a bain-marie (double boiler)	2		150-170 *	/
reheating	3		60-95	/
plate warming	2		75	15



# Cooking with a temperature probe (^BAKESENSOR)

(depending on the model)

The temperature probe allows for accurate monitoring of the core temperature of the food during cooking.



## WARNING!

The temperature probe should not be in direct vicinity of the heating elements.

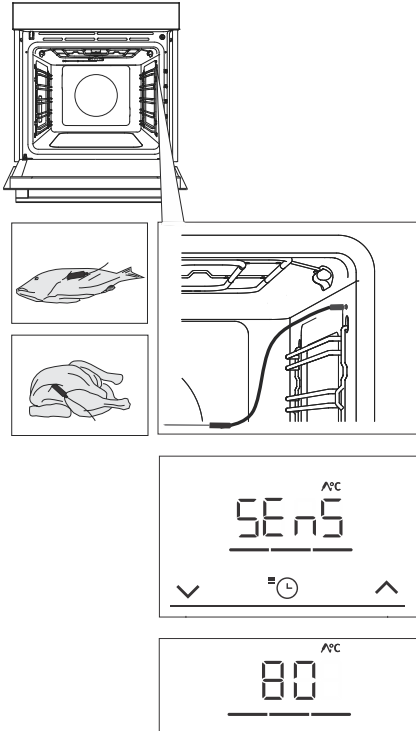

**1** Stick the metal end of the probe into the thickest part of the food.

**2** Plug the probe plug into the socket located in the upper-right corner at the front of the oven cavity (see figure). **SEnS** will appear on the display unit.

NOTE: When you insert the probe into the socket, the preset functions on the oven are deleted.

**3** Select the desired system and cooking temperature (in the temperature range up to 210 °C). The probe operation symbol and the preset temperature will appear on the display unit, which can be changed by touching the keys  $\nabla$  or  $\wedge$ . Determine the desired final core temperature of your food (between 30 and 99 °C).

NOTE: When using the probe, setting the cooking time is not possible.

**4** Confirm the setting by pressing the  $\triangleright$  or  $\square$  key.

**5** When the set core temperature is reached, the oven will stop operating. **End** will appear on the display unit. An acoustic signal will be heard which you may turn off by touching any key. After one minute, the acoustic signal will be switched off automatically.



## INFORMATION!

During the cooking process, set and current food core temperature alternate on the display unit. You may change the cooking temperature or the target food core temperature during the cooking process.

### Correct use of the probe, by type of food:

- poultry: stick the probe in the thickest part of the breast;
- red meat: stick the probe into a lean part that is not marbled with fat;
- smaller chunks with bone: stick them into an area along the bone;
- fish: stick the probe behind the head, towards the spine.



#### **WARNING!**

After use, carefully remove the probe from the food, unplug from the socket in the oven cavity, and clean it.



#### **INFORMATION!**

If you do not use the probe, remove it from the oven.

## Recommended doneness levels for different types of meat

Type of food	blue (raw)	medium rare	medium	medium well	well done
<b>BEEF</b>					
beef, roast	46-48	48-52	53-58	59-65	68-73
beef, sirloin	45-48	49-53	54-57	58-62	63-66
roast beef/rump steak	45-48	49-53	54-57	58-62	63-66
burgers	49-52	54-57	60-63	66-68	71-74
<b>VEAL</b>					
veal, sirloin	45-48	49-53	54-57	58-62	63-66
veal, rump	45-48	49-53	54-57	58-62	63-66
<b>PORK</b>					
roast, neck	/	/	/	65-70	75-85
pork, loin	/	/	/	60-69	/
meat loaf	/	/	/	/	80-85
<b>LAMB</b>					
lamb	/	60-65	66-71	72-76	77-80
<b>MUTTON</b>					
mutton	/	60-65	66-71	72-76	77-80
<b>GOAT MEAT</b>					
goat	/	60-65	66-71	72-76	77-80
<b>POULTRY</b>					
poultry, whole	/	/	/	/	82-90
poultry, breast	/	/	/	/	62-65
<b>FISH AND SEAFOOD</b>					
trout	/	/	/	62-65	/
tuna	/	/	/	55-60	/
salmon	/	/	/	52-55	/

# Cleaning and maintenance



## WARNING!

Before cleaning, unplug the appliance from the power mains and wait for the appliance to cool down.

**Children should not clean the appliance or perform maintenance tasks without proper supervision.**

For easier cleaning, oven cavity and baking tray are coated with special enamel for a smooth and resistant surface.

Regularly clean the appliance and use warm water and hand dishwashing liquid to remove larger impurities and limescale. Use a clean soft cloth or sponge cloth.

**Appliance exterior:** use hot soapsuds and a soft cloth to remove impurities, then wipe the surfaces dry.

**Appliance interior:** for stubborn dirt and grime, use conventional oven cleaners. When using such cleaners, thoroughly wipe the appliance with a wet cloth to remove all cleaner residue.

**Accessories and guides:** clean with hot soapsuds and a damp cloth. For stubborn dirt and grime, we recommend prior soaking and use of a brush.

If the cleaning results are not satisfactory, repeat the cleaning process.



## INFORMATION!

Never use aggressive or abrasive cleaners and accessories (abrasive sponges and detergents, stain and rust removers, scrapers for glass ceramic plates).

Oven equipment is dishwasher-safe.

Food residue (fat, sugar, protein) can ignite during the use of the appliance. Therefore, remove larger chunks of dirt from the oven interior and accessories before each use.

## Using the Steam Clean program to clean the oven

This program makes it easier to remove any stains from inside the oven.

The function is the most effective if used regularly, after each use.

Before running the cleaning program, remove all large visible chunks of dirt and food residues from the oven cavity.

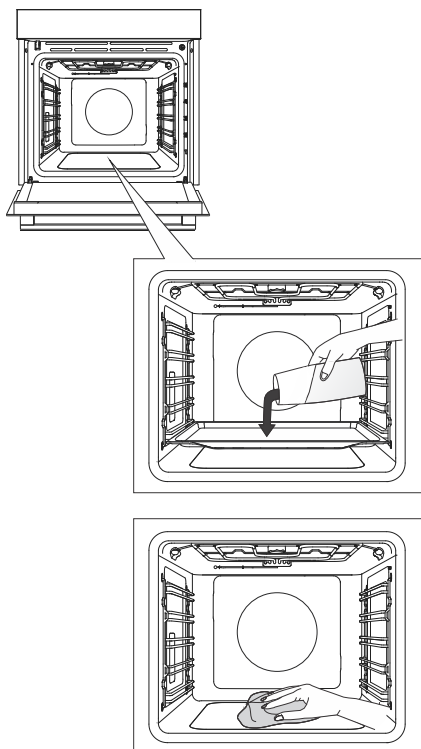

**1** Insert the shallow baking tray into the first guide level and pour 0.4 litres of hot water into it.

**2** Turn the SYSTEM SELECTOR KNOB to Steam Clean . Set the TEMPERATURE KNOB to 80°C.

**3** Let the program operate for half an hour.

**4** When the program is completed, carefully remove the baking tray, using oven mitts (there can still be some water on the baking tray). Wipe down the stains with damp cloth and soapsuds. Thoroughly wipe the appliance with a wet cloth to remove all cleaner residue.



### INFORMATION!

If the cleaning process is not successful (in case of particularly stubborn dirt), repeat it.



### WARNING!

Use the Steam Clean system when the oven has fully cooled down.

## Removing wire and fixed pull-out (extendible) guides

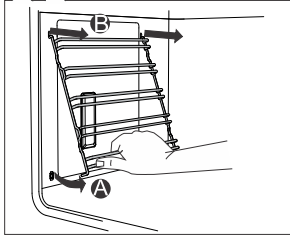
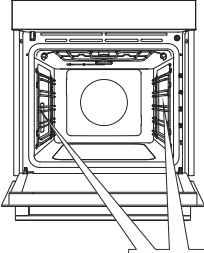

**A** Hold the guides by the bottom side and pull them towards the center of the oven cavity.

**B** Remove them from the openings at the top.

 **INFORMATION!**  
When removing the guides, take care not to damage the enamel coating.

# Removing and replacing the oven door and glass panes

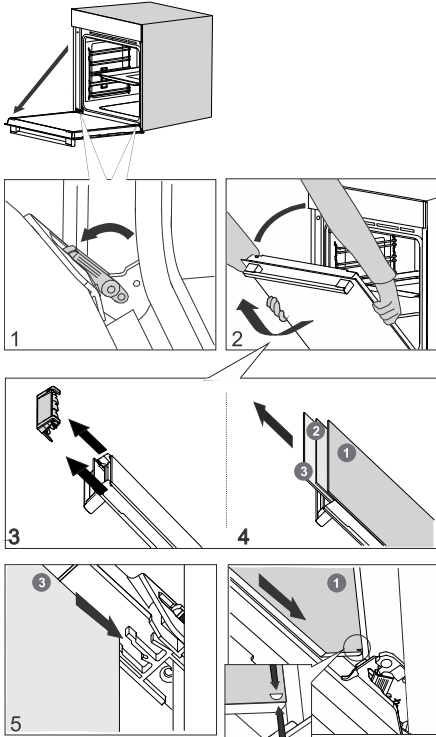

**1** First, fully open the door (as far as it will go).

**2** Oven door is attached to the hinges with special supports that also include safety levers. Rotate the safety levers towards the door by 90°. Slowly close the door to a 45° angle (relative to the position of the fully closed door); then, lift the door and pull it out.

Oven **door glass pane** can be cleaned from the inside, but it has to be removed from the appliance door first. First, proceed as described under item 2, but do not remove it.

**3** Remove the air guide. Hold it on the left- and right-hand side of the door with your hands. Remove it by slightly pulling it towards you.

**4** Hold the door glass at the upper edge and remove it. To the same for the second and third glass pane (depending on the model).

**5** To replace the glass panes, observe the reverse order.

## **INFORMATION!**

To replace the door, follow the reverse order. If the door does not open or close properly, make sure the notches on the hinges are aligned with the hinge beds.

## **WARNING!**

The oven door hinge can close with considerable force. Therefore, always rotate both safety levers to the support when fitting or removing the appliance door.

## **Soft door closing and opening**

(depending on the model)

Oven door is fitted with a system that dampens the door closing force, starting at the a 75° angle. It allows simple, quiet, and gentle opening and closing of the door. A gentle push (to a 15° angle relative to the closed door position) is enough for the door to close automatically and softly.

## **WARNING!**

If the force applied to close the door is too strong, the effect of the system is reduced or the system will be bypassed for safety.

# Replacing the bulb

The bulb is a consumable and therefore not covered by warranty. Before replacing the bulb, remove all accessories from the oven.

Halogen lamp: G9, 230 V, 25 W

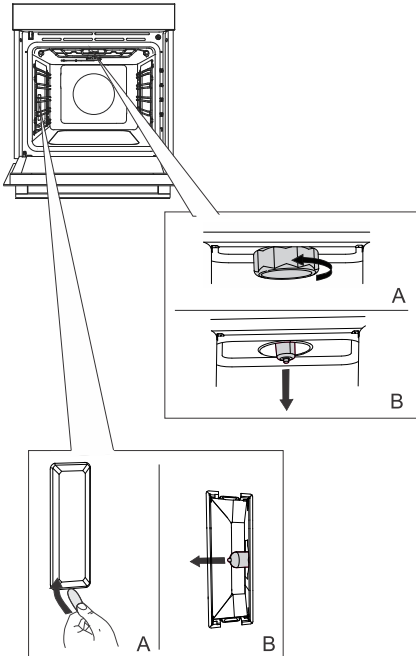

**1** Unscrew and remove the cover (in anti-clockwise direction). Remove the halogen bulb.

**2** Use a flat plastic tool to remove the cover. Remove the halogen bulb.

 **INFORMATION!**  
Take care not to damage the enamel coating.  
Use protection to avoid burning yourself.

 **WARNING!**  
Only replace the light bulb when the appliance is disconnected from power supply.

# Troubleshooting table

## Special warnings and fault reporting

**During the warranty period, only a service center authorized by the manufacturer may carry out any repairs.**

Before making any repairs, make sure the appliance is disconnected from the power mains either by removing the fuse or by disconnecting the power plug from the wall outlet.

Any unauthorized repairs of the appliance may result in electric shock and short circuit hazard; therefore, do not perform them. Leave such work to an expert or a service technician.

In case of minor problems with appliance operation, check this manual to see if you can fix the problem yourself.

If the appliance is not operating properly or at all due to inappropriate operation or handling, a visit from a service technician shall not be free of charge, even during the warranty period.

Save the instructions for future reference and pass them on to any subsequent owners or users of the appliance.

Following is some advice on rectifying some common problems.

<b>Problem/error</b>	<b>Cause</b>
<b>The main fuse in your home trips often.</b>	Call a service technician.
<b>The oven lighting does not work.</b>	The process of changing the light bulb in the oven is described in the chapter Replacing the bulb.
<b>Control unit is not responding, the screen is frozen.</b>	Disconnect the appliance from the power mains for a few minutes (undo the fuse or switch off the main switch); then, reconnect the appliance and switch it on.
<b>Error code ErrX is displayed. In case of a double-digit error code, ErXX will be displayed.</b>	There is an error in the electronic module operation. Disconnect the appliance from the power mains for a few minutes. If the error is still indicated, call a service technician.
<b>The display will show SEnS when the temperature probe is not connected.</b>	Clean the socket. Try to connect and disconnect the temperature probe several times in succession.

If the problems persist despite observing the above advice, call an authorized service technician. Repair or any warranty claim resulting from incorrect connection or use of the appliance shall not be covered by the warranty. In this case, the user will cover the cost of repair.



# Disposal



Our product packaging is made of environmentally friendly materials that can be recycled, disposed of, or destroyed without any hazard to the environment. To this end, packaging materials are labelled appropriately.

**The symbol** on the product or its packaging indicates that the product should not be treated as normal household waste. Take the product to an authorized collection centre for waste electric and electronic equipment processing.

Correct **disposal** of the product will help prevent any negative effects on the environment and health of people, which could occur in case of incorrect product removal. For detailed information on removal and processing of the product, please contact the relevant municipal body in charge of waste management, your waste disposal service, or the store where you bought the product.

We reserve the right to any changes and errors in the instructions for use.

# Cooking test



















EN60350-1: Only use equipment supplied by the manufacturer.

Always insert the baking tray all the way to the end position on the wire guide. Place pastry or cakes baked in moulds as shown in the image.





\* Preheat the appliance until it reaches the set temperature. Do not use the rapid preheat mode.

\*\* Preheat the appliance for 10 minutes. Do not use the rapid preheat mode.

\*\*\* Turn after 2/3 of cooking time.

BAKING						
Dish	Equipment	mould placement		°C	min	
biscuits/cookies – single rack	shallow baking tray		3	140	30-40	
biscuits/cookies – single rack	shallow baking tray		3	150	30-40	
cookies – two racks/levels	shallow baking tray		2, 4	140	45-55	
cookies – three racks/levels	shallow baking tray		1, 4, 5	135	50-60	
cupcakes – single rack	shallow baking tray		3	160 *	20-30	
cupcakes – single rack	shallow baking tray		3	160	30-40	
cupcakes – two racks/levels	shallow baking tray		2, 4	145	40-50	
cupcakes – three racks/levels	shallow baking tray		1, 3, 5	140-150	30-50	
sponge cake	round metal mould, diameter 26 cm/wire rack		1	150	45-55	
sponge cake	round metal mould, diameter 26 cm/wire rack		3	160	45-55	
sponge cake – two racks/levels	2 × round metal mould, diameter 26cm/wire rack		2, 4	160 **	45-55	
apple pie	2 × round metal mould, diameter 20cm/wire rack		1	170	90-120	
apple pie	2 × round metal mould, diameter 20cm/wire rack		2	170	80-110	

**BROILING**

Dish	Equipment	mould placement		°C	⌚ min	
toasted bread	wire rack		5	230	4-7	
pljeskavica (minced meat patty)	wire rack + shallow baking sheet as drip tray		5	230	20-35 ***	

**Hisense**  
life reimagined



853774-a16

