

gorenje

EN

User Manual

Gas Hobs

BG6xA - BG6xB - BG6xC

BG6xD - BG6xE

Simplicity
COLLECTION

The following symbols are used throughout the manual, and they have the following meanings:

 **INFORMATION!**
Information, advice, tip, or recommendation

 **WARNING!**
Warning – general danger

 **GAS CONNECTION!**
Warning – gas connection

 **ELECTRIC SHOCK!**
Warning – danger of electric shock

 **HOT SURFACE!**
Warning – danger of hot surface

 **DANGER OF FIRE!**
Warning – danger of fire

✓ **RIGHT!**

✗ **WRONG!**



It is important that you carefully read the instructions.

Contents

Safety regulations	4
READ CAREFULLY AND KEEP IT FOR FUTURE REFERENCE!	4
Gas hob	7
Safe use	8
User Manual	9
Models	9
Description	10
Information according to regulation (EU only) 66/2014	11
Use	11
Burner position:	14
Cleaning:	14
Faults table	14
Installation instruction	16
Safety regulations	16
.....	16
Preparations for installation	18
Sealing tape	19
Gas connection	19
Accessibility	20
Built-in	20
Connecting & testing	21
Conversion instruction	22
Conversion table	22
Power table (kW-g/h):	23
Converting nozzles	24
Converting by-pass screws	24
Check for gas tightness and operation	25
Startup	25
Checking operation	25
Environmental considerations	26
Disposal of the appliance and packaging	26

Safety regulations



READ CAREFULLY AND KEEP IT FOR FUTURE REFERENCE!

General

- The manufacturer cannot be held liable for any damage resulting from failure to follow the safety instructions and warnings.
- Damage caused by incorrect connection, incorrect fitting, or incorrect use is not covered by the warranty.

WARNING!

This appliance and the accessible parts will become hot during use. Do not touch hot parts. Keep children younger than 8 away from the appliance unless they are under continuous supervision.

WARNING!

Use only hob guards designed by the manufacturer of the cooking appliance or indicated by the appliance manufacturer in the instructions for use as suitable or hob guards incorporated in the appliance. The use of inappropriate guards can cause accidents.

 **DANGER OF FIRE!**

- **WARNING:** Danger of fire: do not store items on the cooking surfaces.
- **WARNING:** Cooking with fat or oil on a hob without supervision can be dangerous and can lead to a fire.
- **CAUTION!** The cooking process has to be supervised. A short term cooking process has to be supervised continuously.
- NEVER try to extinguish a fire with water. Instead, switch the appliance off and then cover the flames with, for example, a lid or a fire blanket.
- The hob is only to be used for the preparation of food.
- The appliance is not designed for heating rooms.
- Do not warm closed tins on the hob. There will be a build-up of pressure that will cause tins to explode. You might get injured or scalded.
- The appliance is not intended to be operated by means of an external timer or separate remote control system.
- Never open the casing of the appliance.
- Never use a pressure cleaner or steam cleaner to clean the hob.
- The ceramic top is extremely strong but not unbreakable. For example, a spice jar or sharp utensil falling on it could cause it to break.

- If a drawer underneath the appliance is permitted (see the installation instructions), without an intermediate bottom, this should not be used to store highly flammable objects/materials. Ensure that there is adequate clearance of a few centimetres between the bottom of the hob and the contents of any drawers.

 **ELECTRIC SHOCK!**

WARNING! In case of hotplate glass breakage:

- Shut immediately off all burners and any electrical heating element and isolate the appliance from the power supply.
- Do not touch the appliance surface.
- Do not use the appliance.

 **WARNING!**

- This appliance can be used by children aged 8 years and over, as well as by people with reduced physical, sensory or mental capabilities or lack of experience and knowledge, provided they are supervised and instructed in the safe use of the appliance and understand the hazards involved.
- Do not allow children to play with the appliance.
- Do not allow children to clean or maintain the appliance unless supervised.
- Do not keep objects that children might find interesting in cupboards above or behind the appliance.

- The cooking zones/burners heat up during use and stay hot for a while afterwards. Keep young children away from the hob during and immediately after cooking.

Gas hob

- **CAUTION!** The use of a gas cooking appliance results in the production of heat, moisture and products of combustion in the room in which it is installed. Ensure that the kitchen is well ventilated especially when the appliance is in use. Keep natural ventilation holes open or install a mechanical ventilation device (mechanical extractor hood).
- The burner components are hot during and immediately after use. Do not touch them, and avoid contact with non-heat resistant materials.
- The distance between the pan and a knob or non-heat resistant wall should always be greater than one centimetre. In the case of smaller distances, the high temperature may cause the knobs or wall to discolour and/or deform.

Safe use

- Never cover the appliance with a cloth or something similar. If the appliance is still hot or is switched on, there is a risk of fire.
- Do not use the appliance as a worktop. The appliance may accidentally be switched on or still be hot, which means objects could melt, become hot or catch fire.
- Do not use the appliance in temperatures below 5 °C.
- The appliance should not be placed or used outdoors.
- When you use the hob for the first time, you will notice a “new smell”. Don’t worry, this is normal. If the kitchen is well ventilated, the smell will soon disappear.
- Never flambé under a cooker hood. The high flames can cause a fire, even if the cooker hood is switched off.
- Always place the pan on the pan support. Placing the pan directly on the burner cap can result in dangerous situations.
- Aluminium trays or foil are not suitable as cooking utensils. They can burn into the burner caps and pan supports.
- The hob can only function effectively if the burner components have been assembled using the guide ridges. Ensure that the pan supports lie properly against each other and flat on the drip tray. Only then can the pans be positioned stably.
- Keep oven gloves or oven cloths away from the flame.
- Do not use griddle plates or baking plates.
- Clean the burner parts regularly for the safe and correct operation of the burners.
- Missing rubber feet from the pan supports can cause scratches on the drip tray or poor combustion of the burner. If the rubber feet are missing, please contact our service department.
- Always use the pan supports and suitable cookware.
- Never immerse hot burner caps and pan supports in cold water. Rapid cooling can damage the enamel.

User Manual

Models

- Aa - Auxiliary burner
- Bb - Semi-rapid burner
- Cc - Rapid burner
- Dd - Wok burner

BG6xA

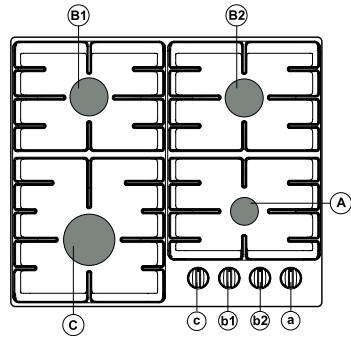

BG6xB / BG6xC

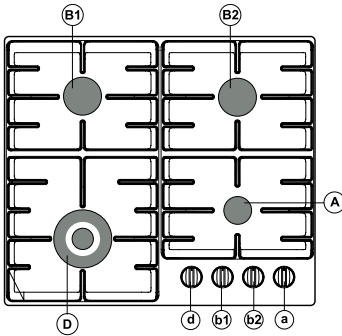

BG6xD

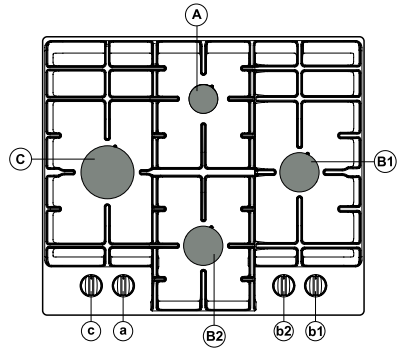

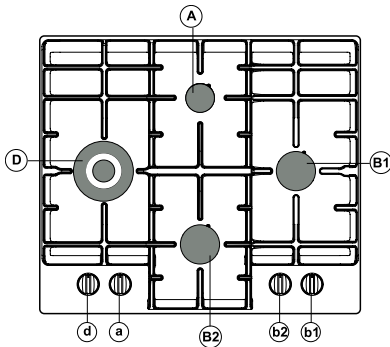

BG6xE



Description

	G20 - 20 mbar				
	Burner	Power	BG6xA BG6xD	BG6xB BG6xE	BG6xC
Aa	Auxiliary	1.05 kW	x	x	x
Bb	Semi-rapid	1.80 kW	x	x	x
Cc	Rapid	3.00 kW	x		
Dd	Wok	3.50 kW		x	
Dd	Wok	4.05 kW			x

	G30/G31 - 28-30/37 mbar				
	Burner	Power / Mass flow	BG6xA BG6xD	BG6xB BG6xE	BG6xC
Aa	Auxiliary	1.05 kW / 76 g/h	x	x	x
Bb	Semi-rapid	1.70 kW / 122 g/h	x	x	x
Cc	Rapid	3.00 kW / 216 g/h	x		
Dd	Wok	3.50 kW / 252 g/h		x	
Dd	Wok	3.90 kW / 281 g/h			x

	G30/G31 - 50 mbar				
	Burner	Power / Mass flow	BG6xA BG6xD	BG6xB BG6xE	BG6xC
Aa	Auxiliary	1.00 kW / 72 g/h	x	x	x
Bb	Semi-rapid	1.90 kW / 137 g/h	x	x	x
Cc	Rapid	3.00 kW / 216 g/h	x		
Dd	Wok	3.50 kW / 252 g/h		x	
Dd	Wok	3.80 kW / 274 g/h			x

	G20 - 25 mbar				
	Burner	Power / Mass flow	BG6xA BG6xD	BG6xB BG6xE	BG6xC
Aa	Auxiliary	1.15 kW	x	x	
Bb	Semi-rapid	2.00 kW	x	x	
Cc	Rapid	3.30 kW	x		
Dd	Wok	3.90 kW			x

Information according to regulation (EU only) 66/2014

Measurements according to EN60350-2

Model identification		BG6xA BG6xD	BG6xB BG6xC BG6xE
Type of hob		Gas hob	Gas hob
Number of gas burners		4	4
Heating technology		Gas burner	Gas burner
Energy efficiency per gas burner ($EE_{\text{gas burner}}$) in %	Semi-rapid burner:	58.1	58.1
	Rapid burner:	57.1	-
	Wok burner:	-	55.1
Energy efficiency for the gas hob ($EE_{\text{gas hob}}$) in %		57.8	57.1

Use

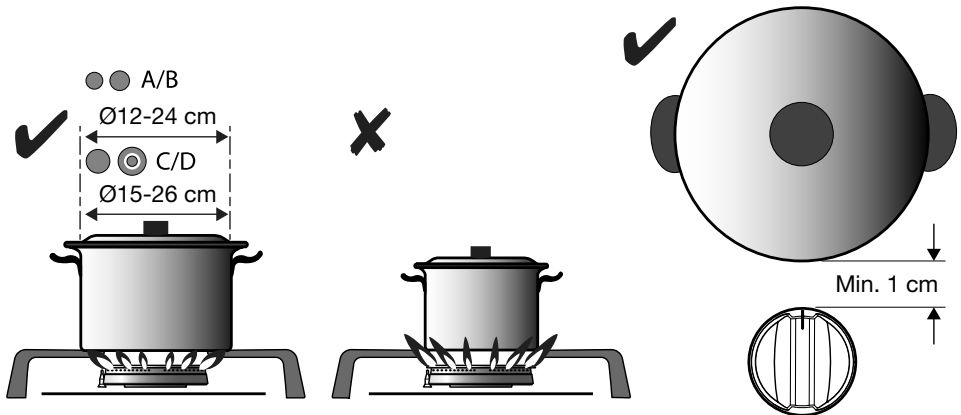

WARNING!

The distance between the pan and a non-heat resistant wall should always be greater than one centimetre. In the case of smaller distances, the high temperature may cause the knobs or wall to discolour and/or deform.

Control:

- (1) Push
- (2) Turn left + hold
- (3) Hold down 3 sec.

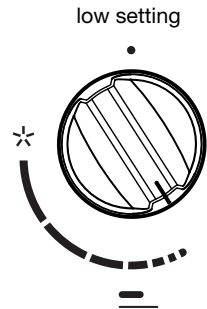
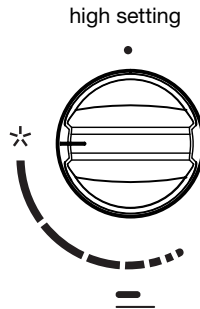
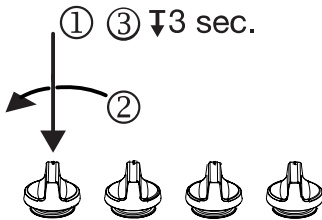

Cooking timer function:



Sensor key

Depending on the model, your hob can have a cooking timer function. For both left cooking zones, the cooking time can be set (from 1 to 99 minutes). When the countdown cooking time expires, the selected burner extinguishes.

- If you decide to disable the timer function earlier yourself, after you have set the timer, the burner does not extinguish.
- If you extinguish the burner earlier yourself (by turning the knob to position '0'), the timer does not stop.
- In case of an electrical power failure, the burner will immediately extinguish and the timer will stop.

How to set the cooking timer

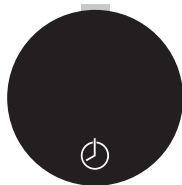

1. Ignite the burner of the cooking zone.
2. Touch the sensor key on the knob for about 2 seconds.
3. You hear an acoustic signal and '- 00 +' appears.
4. Touch key '+' or key '-' to set the desired cooking time. After 5 seconds, key '+' and key '-' disappear and the countdown starts. At the end of the cooking time, the burner extinguishes. You hear an acoustic signal and '- 00 +' is blinking.
5. Touch any key to stop the acoustic signal. After 1 minute the acoustic signal stops automatically.
6. Turn the control knob to position '0'.



You can set 99 minutes immediately by touching key '-' first. Then the time decreases.

How to change the cooking time

During cooking, it is possible to change the remaining cooking time that has been set.

1. Key '+' and key '-' appear.
2. Touch key '+' or key '-' to change the cooking time.

How to disable the cooking timer

1. Touch the sensor key on the knob for about 2 seconds.
2. Key '+' and key '-' appear.
3. Then touch the sensor key again for about 2 seconds.
4. The cooking timer is disabled.
5. Turn the control knob to position '0' if you want to extinguish the burner.



WARNING!

Do not remove the control knobs with timer control function.

Accessories (to be obtained via After Sales):

Following accessories are optional and can be ordered separately:



Suits wok burner

Code: 806206

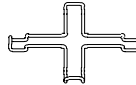

Suits Auxiliary burner

Code: 537584

Burner position:

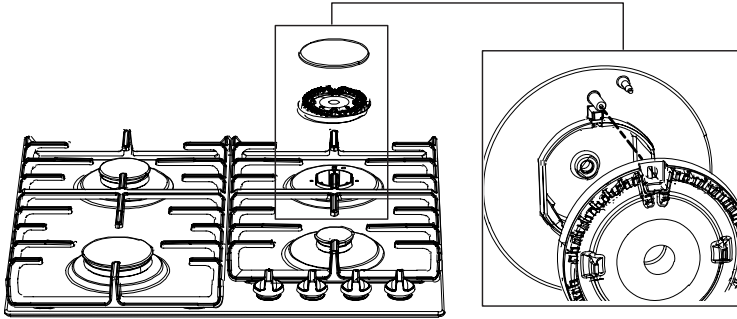

Cleaning:

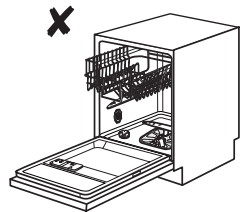
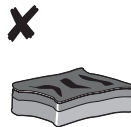

Faults table

Following is some advice on rectifying some common problems.

What happened...?	Possible cause	What to do?
The burners will not burn. The flame is uneven/unstable.	The flame is uneven due to a wrong gas power setting.	Have an expert check the gas pipeline!
The flame from the burners suddenly changes.	Wrongly assembled parts of the kitchen hob.	Assemble the burner correctly.
Burner ignition takes more time.	Wrongly assembled parts of the kitchen hob.	Assemble the burner correctly.
The flame is extinguished shortly after ignition.	Knob pressed too short or too weakly.	Keep the knob pressed for a longer period of time.

Table continued from last page

What happened...?	Possible cause	What to do?
The grid has discoloured in the burner area?	This is a commonplace phenomenon resulting from high temperatures.	Clean the grid with a metal care detergent.
Electric power supply, in general, is interrupted?	The fuse may be blown.	Check the fuse in the fuse box and replace it if it is blown.
Electric ignition of the burners no longer works?	There are food or detergent residues between the spark plug and the burner.	Open and carefully clean the opening between the spark plug and the burner.
The burner cover looks unappealing.	Regular dirt.	Clean the burner covers with a metal care detergent.

A visit by a service technician during the warranty period will be charged if the appliance is not functioning because of improper use. Store these instructions in a place where they are always readily accessible; if you pass the appliance on to another person, the instructions should also be included.



NOTE!

If the problem persists despite observing the instructions above, call an authorized service technician. Elimination of any errors or warranty claims that resulted from an improper connection or use of the appliance is not covered by our warranty. In such cases, the costs of repair are borne by the user.

Installation instruction

Safety regulations



- Faulty parts may only be replaced by original parts.

The manufacturer can only guarantee that original parts meet safety requirements.

- If the supply cord is damaged, it must be replaced by the manufacturer, its service agent or similarly qualified persons in order to avoid a hazard.
- This appliance should only be connected by a registered installer.
- Prior to installation, ensure that the local distribution conditions (voltage, frequency, nature of the gas and gas pressure) and the adjustment of the appliance are compatible.
- This appliance must be earthed.
- The voltage, frequency, power, type of gas and the country for which the appliance has been designed are shown on the appliance rating plate.
- Electrical connection Class I - 220-240 V - 50/60 Hz - max 1 W.
- The electrical connection must comply with national and local regulations.
- The wall plug socket and plug should always be accessible.
- If a stationary appliance is not fitted with a supply cord and a plug, or with other means for disconnection from the supply mains having a contact separation in all poles that provide full disconnection under overvoltage category III conditions, the means for disconnection must be incorporated in the fixed wiring in accordance with the wiring rules. Using an omnipolar switch with a contact separation of at least 3 mm fitted in the supply cable will fulfil this requirement.
- The supply cord must hang freely and should not be fed through a drawer.
- Gas connection 1/2" ISO 228 / ISO 7-1 / EN 10226-1 (1/2" ISO 228 / 1/2" ISO 228 FR only).
- The gas connection must comply with national and local regulations. See appliance label for technical gas data.
- This appliance is not connected to a combustion products evacuation device. It shall be installed and connected in accordance with current installation regulations. Particular attention shall be given to the relevant requirements regarding ventilation.
- We recommend that the gas hob be connected by means of a fixed pipe. Connection using a specially designed safety hose is also permitted.
- The pipe behind the oven must be made entirely out of metal.

- A safety hose may not be bent and must not come into contact with moving parts of kitchen units.
- The gas supply valve must always be placed in an easily accessible position.
- The worktop into which the hob is fitted should be flat.
- The walls and the worktop surrounding the appliance must be heat resistant up to at least 105 °C.

Preparations for installation

Free space around the appliance

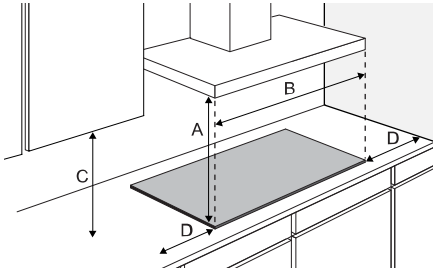

A (mm)	B (mm)	C (mm)	D (mm)
min. 650	min. 600	min. 450	min. 120

Dimensions

Appliance:

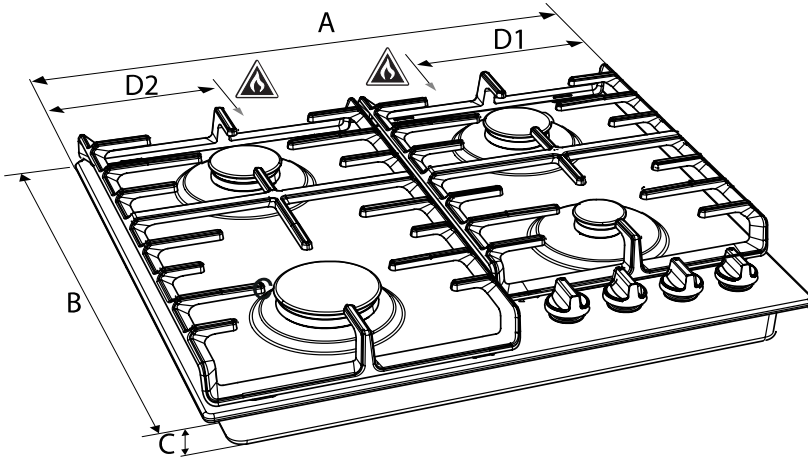

	A (mm)	B (mm)	C (mm)	D1 (mm)	D2 (mm)
BG6xA/B/C	600	520	52	-	138
BG6xD/E	600	520	52	138	-

Built-in:

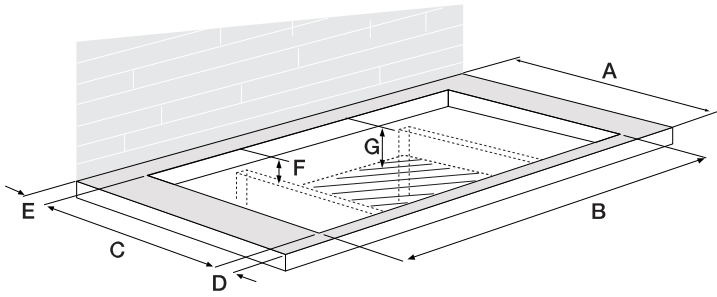

	A (mm)	B (mm)	C (mm)	D (mm)	E (>mm)	F (mm)	G (mm)
BG6	600	560	490	60	50	90	100

Sealing tape

Stainless steel drip tray

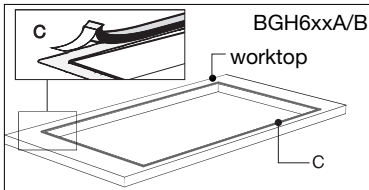

Glass drip tray

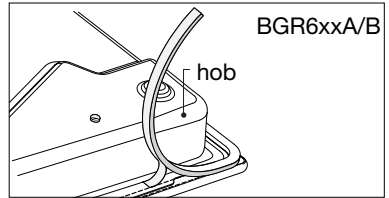

Gas connection

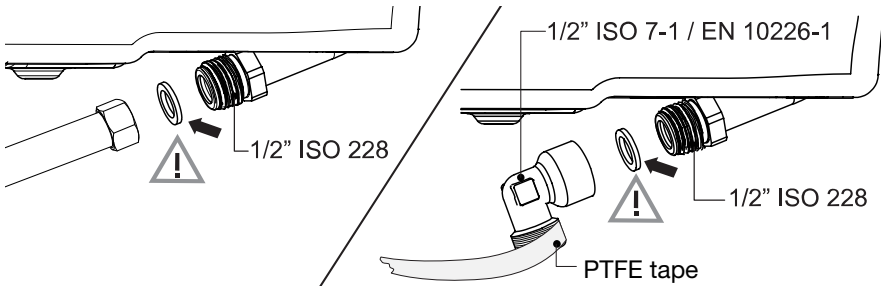

Accessibility

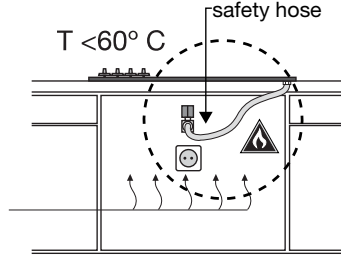
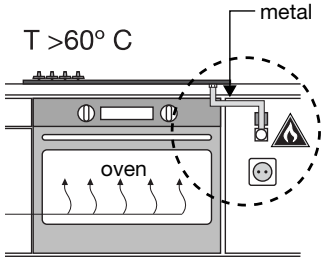
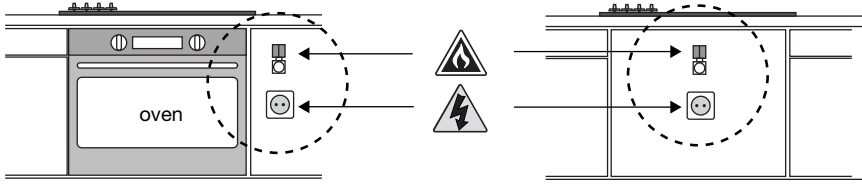

Built-in

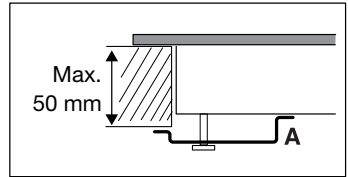
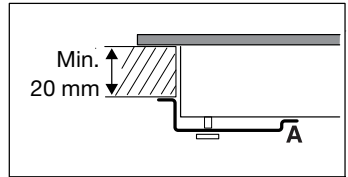
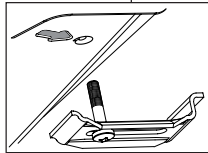
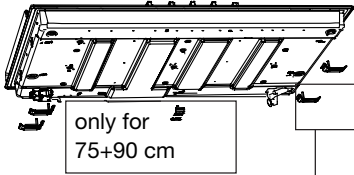
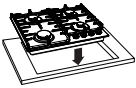

Connecting & testing

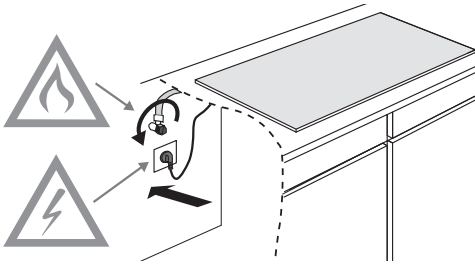

WARNING!

Check if connections are gas-tight.

Conversion instruction



WARNING!

Adjusting for a different gas type!



WARNING!

Attention! Performing these instructions by a non-qualified person can lead to dangerous situations. The supplier is not responsible for the consequences (the arising of a hazardous situation and/or damage to persons or goods) caused by the incorrect performance of these instructions by engineers who are not employees of the supplier. Consequential damage arising through the inexpert performance of these instructions is not accepted.

With this conversion set, your gas hob can be converted to different gasses. See the conversion table.

Conversion table

Gas type	P mbar	Modification	Auxiliary	Semi rapid	Rapid
			nozzle	nozzle	nozzle
G20	20 / 25	-	72	97	128
Convert from G20 - 20 mbar or from G20 - 25 mbar to:					
G20	13	Replace nozzle & no action bypass	84	115	145
G30/G31	28-30/37	Replace nozzle & screw in bypass (see 3A)	50	65	85
(PL) G30/G31	37	Replace nozzle & screw in bypass (see 3A)	50	65	85
G30/G31	50	Replace nozzle & screw in bypass (see 3A)	43	60	75

Gas type	P mbar	Modification	Auxiliary	Semi rapid	Rapid
			nozzle	nozzle	nozzle
G30/G31	28-30/37	-	50	65	85
Convert from G30/G31 - 28-30/37 mbar to:					
G20	20 / 25	Replace nozzle & adjust bypass (see 3C)	72	97	128

Gas type	P mbar	Modification	Wok (BG6xB/E)	Wok (BG6xC)
			nozzle	nozzle
G20	20 / 25	-	142	150
Convert from G20 - 20 mbar or from G20 - 25 mbar to:				
G20	13	Replace nozzle & no action bypass	155	170
G30/G31	28-30/37	Replace nozzle & screw in bypass (see 3A)	94	100
(PL) G30/G31	37	Replace nozzle & screw in bypass (see 3A)	94	94
G30/G31	50	Replace nozzle & screw in bypass (see 3A)	76	78

Gas type	P mbar	Modification	Wok (BG6xB/E)	Wok (BG6xC)
			nozzle	nozzle
G30/G31	28-30/37	-	94	100
Convert from G30/G31 - 28-30/37 mbar to:				
G20	20 / 25	Replace nozzle & adjust bypass (see 3C)	142	150 (not for G20 25 mbar)

Power table (kW-g/h):

	G20 - 13 mbar	PL G30/G31 - 37 mbar
Auxiliary burner	1.05	1.15 / 83
Semi-rapid burner	1.95	1.95 / 140
Rapid burner	3.10	3.30 / 238
Wok burner (BG6xB/E)	3.45	3.90 / 281
Wok burner (BG6xC)	4.00	3.90 / 281

Contents of conversion set

- Nozzles for burners and (if applicable) by-pass screws for gas taps.
- Data label with the modified gas specifications and setting.

Tools needed:

- T1 Socket spanner (7 mm)
- T2 Screwdriver flat blade (4 mm)
- T3 Nose pliers
- T4 Open-end spanner (7 mm)
- T5 Leak test spray

Converting nozzles



NOTE!

Please note: disconnect the appliance from the power supply.

Prevent damage of the worktop. Lay down parts of the appliance on a protected base.

For converting to a different type of gas, the nozzles have to be changed.

The values are also marked on the nozzle.

1. Remove pan supports, burner heads, crowns and covers (see pictures A1 and A2). Pull off the control knobs vertically.
2. Use the socket (T1) or open-end spanner (T4) to remove the old nozzles and place the new nozzles inside the burner cups (see pictures A1 and A2).

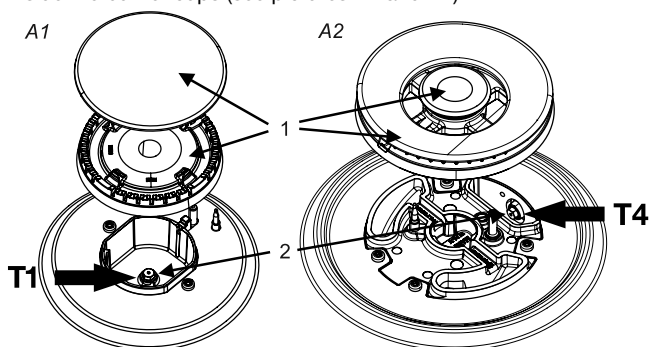

Converting by-pass screws

Depending on the gas type to which the appliances will be converted, there are two ways to adjust the by-pass screws.

Please check the conversion table in the column “Modification” if the by-pass screws have to be screwed completely in (see action 3A), replaced by a different by-pass screw (see action 3B) or adjusted (see action 3C).

The values are also indicated on the top of the by-pass screws. The by-pass screws can be reached from the top of the hob when the knobs are removed (B2).

3A. Screw the by-pass screws (3) of all gas taps completely in by using the flat-blade screwdriver (T2).

3B. Remove the by-pass screws by using the flat-blade screwdriver (T2) and the nose pliers (T3). Place the new by-pass screws with the nose pliers and screw the by-pass screws of all gas taps in, by using the flat-blade screwdriver.

3C. Adjust the by-pass screws (3) of all gas taps by using the flat-blade screwdriver (T2) until a stable flame is established with a minimal gas flow. Please check if the flame is stable in the cold and hot conditions of the burner.

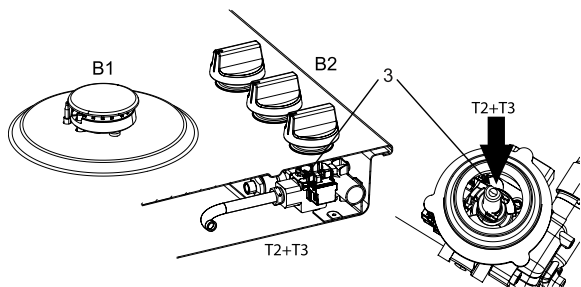

Check for gas tightness and operation

When the appliance is connected to the gas supply, use leak test spray to check the gas tightness.

1. Seal the injector.
2. Open the gas tap. **Attention:** press and open the tap to override the thermo-electric safety device and keep it pressed down.
3. Spray leak test spray over all gas connections and check for gas tightness.
4. Repeat for every burner.

Startup

1. Reinstall the knobs, burner parts and pan supports.
2. Check if the appliance is connected to the correct gas type and pressure.
3. Open the main gas valve.
4. Insert the plug into the power socket.

Checking operation



ADJUSTED FOR	SKORYGOWANIE O	CL
EINGESTELLT AUF	KORRIGIERT	
Э ПОПРАВКОВО НА	НАСТРІВНО ДЛІЯ	
PRILAGODEN ZA	КЕЛЕСИ УШИНИ ТЕНШЕЛГЕН	
PO OCSZENIU O		
PRILAGODIBEN ZA		
AJUSTATE PENTRU	GXX	XX mbar

1. Ignite the burners.
2. Check whether the flame profile is normal, uniform and stable for the complete ratio:
3.
 - Check if the flame does not smother in simmer rate;
 - Check if the flames are not 'blowing off' at maximum rate;
 - No long, yellow flames should be visible during operation.
4. Paste the data label with the modified gas specifications and setting over the current data label with the old specification (at the underside of the appliances nearby the gas connection).

Environmental considerations

Disposal of the appliance and packaging

Sustainable materials have been used during the manufacture of this appliance.

The appliance packaging is recyclable. The following may have been used:

- cardboard;
- paper;
- polyethylene film (PE);
- CFC-free polystyrene (PS-rigid foam);
- polypropylene tape (PP).

Dispose of these materials in a responsible manner and in accordance with government regulations.



To designate the requirement for a separate collection of household electrical appliances, the symbol of a crossed-out dustbin is applied to the product.

This means that at the end of its working life, the product must not be disposed of as urban waste. It must be taken to a special local authority differentiated waste collection centre or to a dealer providing this service. Disposing of a household appliance such as this hob separately avoids possible negative consequences for the environment and health and enables the constituent materials to be recovered, resulting in significant savings in energy and resources.



NOTE!

Please note! Do not throw a broken ceramic glass plate in the glass recycling bin but take this to the Municipality's waste recycling centre.

Declaration of conformity



We hereby declare that our products satisfy the applicable European directives, orders and regulations, as well as the requirements stated in the referenced standards.

gorenje

www.gorenje.com



830509-a9

CE