

gorenje

EN

Operating instructions
Dishwasher

GV662D60



Contents

Your dishwasher	4
Safety instructions	5
Installation	6
Winter storage/transport	6
Overflow guard function	6
Packaging	6
Disposal	6
Before washing for the first time	7
Water hardness	7
Set the Water hardness	7
Top up with salt	7
Set the Rinse aid	8
Top up with rinse aid	8
Greener dishwashing	9
The dishwasher saves energy and water	9
Loading the dishwasher	10
Fragile dishes	10
Loading affects the results	10
The dishwasher's baskets	10
Top cutlery tray	10
Upper basket	11
Lower basket	12
Using the dishwasher	13
Add detergent	13
The main power switch	14
PROGRAMS - Select program	14
EXTRA - Select option	15
Starting the dishwasher	16
TIME - Time remaining	16
Status light	16
Stopping or changing a program	16
If you want to load more dishes	16
If the dishwasher is turned off due to a power failure	16
Once the program has finished	17
How to get the best drying results	17
Unloading the dishwasher	17
Program chart	18
Settings	19
Open the settings menu:	19
You can now adjust the following settings:	19
Care and cleaning	21
Top up with rinse aid	21
Top up with salt	21
Cleaning the filters	22
Cleaning the spray arms	23

Clean the dishwasher inside and out	23
Remove blockages	24
Troubleshooting	26
Installation	31
Safety instructions	31
Setup	31
Drainage connection	32
Connection to water supply	32
Electrical connection	32
Service	34
Technical data and energy labelling	35
Technical data	35
Information for consumers	35
Information for test institute	35

Your dishwasher

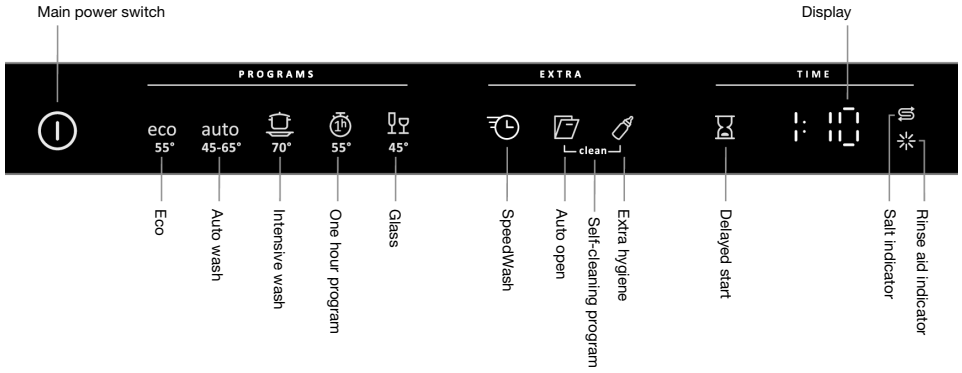

Install the dishwasher, see the chapter Installation. Following this, open the door and press the main power switch to start using the machine.

The first time the dishwasher is switched on, it is important that you choose the right settings to ensure good dishwashing results. See the chapter Before washing for the first time.

Safety instructions

- Read the operating instructions and keep them in a safe place!
- Number of standard place settings: 16
- Never use the dishwasher for any purpose other than that specified in these operating instructions.
- Do not load the dishwasher door or dishwasher baskets with anything other than dishes.
- Never leave the dishwasher door open as someone may trip on it.
- Use only dishwasher detergent!
- This machine can be used by children aged 8 and upwards, and by people with reduced physical capacity, mental ability, memory loss or lacking experience and knowledge. These individuals must be supervised when using the machine or have instructions on how to use the machine and understand the risks that can occur. Cleaning of the machine must not be carried out by children without supervision.
- Damaged mains cables must only be replaced by a qualified electrician.
- Only use the dishwasher in household-type environments for dishwashing household dishes. All other use is prohibited.
- Never place dishes with solvent residues in the dishwasher due to the risk of explosion. Nor may dishes that contain ash, wax or lubricants be washed in the dishwasher.
- Children must be watched. Do not allow children to use or play with the dishwasher. Be especially vigilant when the door is open. Some detergent may remain inside! After adding detergent, always start the dishwasher immediately.



WARNING!

Knives and other pointed items must be placed horizontally in the dishwasher's special cutlery baskets.

**WARNING!**

Children must be supervised – dishwasher detergent is corrosive!

Installation

See the chapter Installation.

Winter storage/transport

Store the dishwasher above freezing and avoid long transport distances in very cold weather. Transport the dishwasher upright or laying on its back.

Overflow guard function

The overflow protection starts pumping out the machine and turns off the water supply if the water level in the dishwasher exceeds the normal level. If the overflow protection is triggered, F54 appears on the display. Turn off the water supply and contact your nearest service centre.

Packaging

The outer packaging protects the product during transport. The packaging material is recyclable. Separate the different packaging materials to help reduce raw material use and waste. Your dealer can take the packaging for recycling or direct you to the nearest recycling centre. The packaging is comprised of:

- Corrugated cardboard made from up to 100% recycled material.
- Expanded polystyrene (EPS) with no added chlorine or fluorine.
- Supports made from untreated wood.
- Protective plastic made from polyethylene (PE).

Disposal

The dishwasher is manufactured and labelled for recycling.

When the dishwasher has reached the end of its service life and is to be disposed of, it should immediately be made unusable. Pull out the power cable and cut it as short as possible.

Contact your local authority for information about where and how your dishwasher should be correctly recycled.

Before washing for the first time

Water hardness

In order to achieve good dishwashing results, the dishwasher needs soft water (water with low mineral content). Hard water leaves a white coating on dishes and the dishwasher.

Checking water hardness

Water hardness is specified using the German water hardness scale (°dH) or the French water hardness scale (°fH).

A water supply with a water hardness in excess of 6°dH (9°fH) must be softened. This is done automatically with the aid of the built-in water softener. In order for the water softener to function optimally, it must be adjusted to the hardness of the water supply. Once you have adjusted the water softener, use detergent and rinse aid doses suitable for soft water.

Contact the local waterworks to check the water hardness in your area.

Make a note of the water hardness: _____

If the water hardness exceeds 50°dH (89°fH), we recommend connecting an external water softener.

Increased consumption during regeneration

The dishwasher's built-in water softener is regularly regenerated to maintain its function. Regeneration extends the dishwashing program and increases energy and water consumption. Just how often the dishwasher's water softener is regenerated depends on the selected setting.

Example: If the Ecoprogram is run with a water hardness of 14 °dH (25 °fH), the water softener is regenerated at regular intervals (after 5 dishwashing cycles), energy consumption increases by 0.015 kWh and water consumption increases by 2.3 litres while the program time is extended by 3 minutes. Regeneration occurs during the program's main wash.

WARNING!

Hard water leaves a white coating on dishes and inside the dishwasher. It is therefore important that you select the right setting for the water softener! See Water hardness in the chapter Settings.

Never run the dishwasher with an empty salt compartment if the water supply has a water hardness in excess of 6°dH (9°fH).

Set the Water hardness

Chapter Settings describes how to adjust the water softener.

Top up with salt

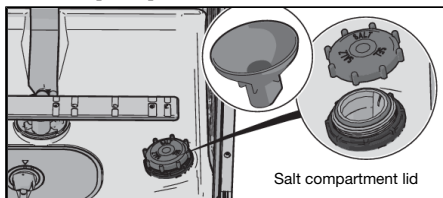

1. Unscrew the salt compartment lid.

2. Place the funnel supplied with the dishwasher in the salt compartment top-up hole. First, pour in about 1 l of water.
3. Then add salt, a maximum of 630 gram, until the compartment is full. Use large grain salt or special dishwasher salt.
4. Wipe up any excess salt so that the lid can be screwed on firmly.

In order to avoid rust stains a dishwashing program must be started immediately after adding salt.

Set the Rinse aid

The chapter Settings describes how to set the rinse aid dosage.

* Top up with rinse aid

Drying is faster and a better result is achieved if you use rinse aid. You will also achieve a better dishwashing result with clear and spotless dishes.

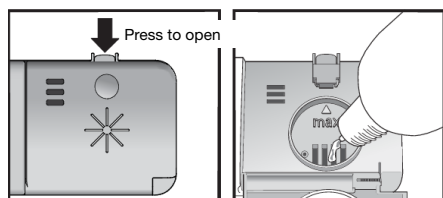

1. Open the rinse aid compartment lid.
2. Carefully top up with rinse aid to the level marked **max**.
3. Wipe up any splashes of rinse aid around the compartment.
4. Close the lid firmly.

Greener dishwashing

The dishwasher saves energy and water

When using a dishwasher in a residential setting, less energy and water are generally used compared to washing the dishes by hand.

Do not rinse under running water

Do not rinse the dishes under running water as this will lead to increased energy and water consumption. Simply scrape off large food particles before loading the dishwasher.

Choose a green detergent

Read the environmental declaration on the packaging!

Too much detergent, rinse aid and salt can result in less effective dishwashing and also entail greater environmental impact.

Run a fully loaded dishwasher

Save energy and water by waiting until the dishwasher is full before running a program (see number of standard place settings).

Run programs at a lower temperature

If the dishes are only slightly dirty, you can select a program with a low temperature.

Select dishwashing program – Eco

This program is suitable for washing normally dirty dishes and is the most effective program in terms of combined energy and water consumption. This program is used to assess compliance with EU legislation on ecodesign.

The dishwashing program is designed for an effective wash using as little energy and water as possible. The program washes at a low temperature for a long time.

Select option – Auto open

Better drying results are achieved if you use the Auto open option, which automatically opens the dishwasher door. Wait until the dishwasher indicates that the program has ended and the dishes have cooled before unloading the dishwasher. (If the dishwasher is built-in the surrounding furnishings must be resistant to any condensation from the dishwasher.)

Connect to cold water

Connect the dishwasher to the cold water supply if the building is heated using oil, electricity or gas.

Connection to hot water supply

Connect the dishwasher to the hot water supply (max. 70 °C) if the building is heated using an energy-efficient means such as district heating, solar power or geothermal power. Choosing a hot water connection cuts dishwashing times and reduces the dishwasher's energy consumption.

NOTE!

Do not exceed the permitted water supply temperature. Certain materials used in some cookware cannot withstand strong heat.

Loading the dishwasher

Fragile dishes

Some cookware is not dishwasher safe. This can be for several reasons. Some materials cannot withstand strong heat, others can be damaged by dishwashing detergent.

Exercise caution with, for example, handmade items, fragile decoration, crystal/glassware, silver, copper, tin, aluminium, wood and plastic. Look for the "Dishwasher safe" marking.

Loading affects the results

Load the dishes carefully to ensure the best washing and drying results with the lowest possible energy and water consumption. Give your dishwasher the best chance to reach and clean all surfaces, as well as to dry the dishes as thoroughly as possible.

- All dirty surfaces should face inwards and downwards!
- Dishes should not be placed in or on each other.
- Angle dishes with hollows, such as cups, so that the rinse water will run off. This is also important for plastic items.
- Make sure small items cannot fall through the dishwasher basket; place them in the top cutlery tray.



NOTE!

Check that the spray arms can rotate freely.

The dishwasher's baskets

The dishwasher is equipped with a top cutlery tray, an upper basket and a lower basket.

The appearance of the baskets may differ depending on the dishwasher setup.

Top cutlery tray

The top cutlery tray has space for cutlery, ladles, whisks, serving cutlery and similar items.

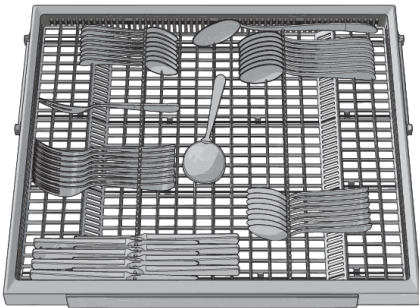

Upper basket

Place glasses, cups, bowls, side plates and saucers in the upper basket. All dirty surfaces should face inwards and downwards! Wine glasses are placed on the wine glass shelf and knives are placed in the knife stand on the right (if fitted).

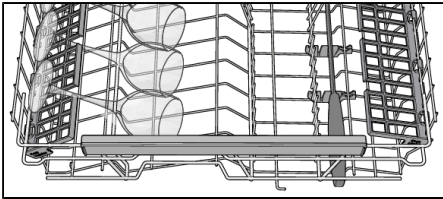
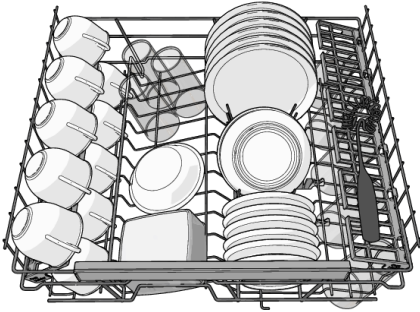

Raising and lowering the upper basket

1. Pull out the upper basket.
2. Grab the sides of the upper basket with both hands and lift it up.
3. Repeatedly lift the basket with both hands to change its position. (The upper basket can be set in three positions.) When the upper basket is in the highest position lifting it will return it to the lowest position. Note that both sides of the basket must always be set to the same height.

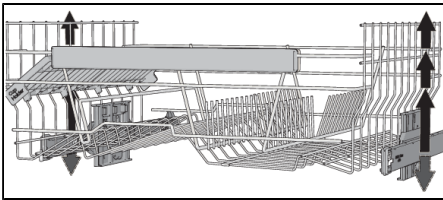

Lower basket

Place plates, side plates, serving dishes and pots in the lower basket.

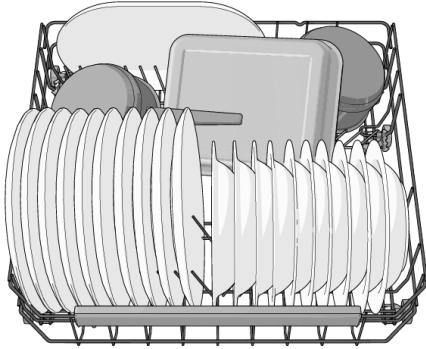

Foldable tines

Fold down the foldable tines (plate supports) when dishwashing pots. Release the foldable tines by pressing the catch inwards before adjusting their position.

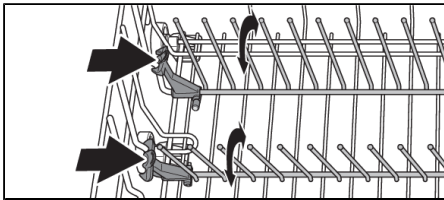

Using the dishwasher

Add detergent

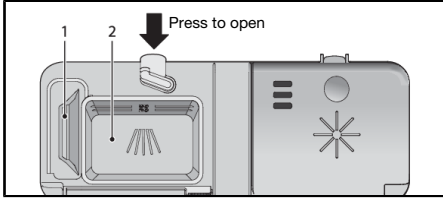

1. Prewash detergent compartment
2. Main wash detergent compartment

Detergent is added according to water hardness.

Follow the instructions on the detergent packaging. This dishwasher is fitted with a water softener, so use detergent and rinse aid doses suitable for soft water.

Too much detergent can result in less effective dishwashing and also entails greater environmental impact.

The detergent compartment must be dry when adding detergent. There is one compartment for the prewash and one for the main wash. If powder or liquid dishwasher detergent is used, add a small amount of the detergent to the prewash compartment. Contact the detergent manufacturer if you have questions about the detergent.

NOTE!

Use only dishwasher detergent! Washing up liquid must not be used as the foam that forms prevents the dishwasher from operating effectively.

Dishwasher tablets

Halve the tablet if it is difficult to close the dispenser lid. There is a risk that the detergent will not be released properly if the lid is tight and will not open correctly.

NOTE!

Dishwasher tablets are not recommended for short programs (less than 75 minutes). Use powder or liquid dishwasher detergent instead.

All-in-one detergent

There are many types of all-in-one detergents on the market. Read through the directions for these products carefully.

Chapter Settings describes how to activate TAB (3-in-1/ All-in-one detergent). Note that salt must be put in the salt compartment. If you are not satisfied with the dishwashing or drying results, deactivate the setting TAB (3-in-1/ All-in-one detergent) and top up with salt, detergent and rinse aid. See Chapter Before washing for the first time.

NOTE!

Optimal washing and drying results are achieved by using normal detergent together with separately dispensed rinse aid and salt.

The main power switch

Press and hold the main power switch until the display lights up. Also check that the water tap is on.

PROGRAMS - Select program

Select a program to suit the type of dishes and how dirty they are. Eco is always pre-selected.

Press the desired program until the program symbol is activated.

eco

55° **Eco**

This program is suitable for washing normally dirty dishes and is the most effective program in terms of combined energy and water consumption. This program is used to assess compliance with EU legislation on ecodesign.

auto

45-65° **Auto wash**

The dishwasher can measure how dirty the dishes are and adjust water consumption and temperature accordingly. When newly installed, the program needs to be run five times before it is fully adapted and can provide the best results.

auto

45-65° +  +  **QuickIntensive**¹⁾

QuickIntensive (Auto wash + SpeedWash + Auto open) is an effective program for slightly dried leftovers. (This program is not intended for burnt food, such as on oven dishes.)



70° **Intensive wash**

A program with a high temperature to dissolve grease on very dirty dishes, such as pans, casserole dishes and oven dishes. If these dishes do not completely fill the dishwasher, you can add plates and the like.



55° **One hour program**

A quick program for slightly dried leftovers. (This program is not intended for burnt food, such as on oven dishes.)

In combination with SpeedWash, a shorter program is achieved (15 minutes).



45° **Glass**

A gentle dishwashing program with a low temperature for washing fragile items made of crystal/glass. Remember to use a small amount of detergent and to place items so that they do not touch each other during the wash. See also Fragile dishes in the chapter Loading the dishwasher. Porcelain that has just been used without dried leftovers can also be washed using this program.

¹⁾ Program time 90 minutes.

clean **Self-cleaning program**

Self-cleaning program for hygienic cleaning of the dishwasher tub, spray arms and spray pipes.

This program should be run (with no dishes in the machine) using normal dishwasher detergent or citric acid. Special dishwasher cleaners are also available on the market. For the removal of limescale deposits, see Dishwasher tub in the chapter Care and cleaning.



Press and hold the option buttons for Self-cleaning program to activate the program. Self-cleaning program starts when the door is closed.

EXTRA - Select option

To select an option, press one of the option buttons until the option is activated. The available options vary between program and some options cannot be combined (available options glow dimly).

SpeedWash

This option shortens the program time, but uses more energy and water.

Auto open²⁾

The dishwasher door opens automatically, which improves the drying results. Wait until the dishwasher indicates that the program has ended and the dishes have cooled before unloading the dishwasher. (If the dishwasher is built-in the surrounding furnishings must be resistant to any condensation from the dishwasher.)

The drying time for the Auto open option varies between programs.

NOTE!

For the best drying results, do not close the door before the drying phase has finished and the machine has automatically switched off.

WARNING!

The dishwasher door must not be blocked or closed when opened automatically. Doing so may damage the door lock mechanism. Wait at least 5 minutes before closing the door.

Extra hygiene

This option is intended for situations where demands on hygiene are especially high, such as when dishwashing baby bottles and cutting boards. The temperature is increased in both the main wash and the final rinse.

Delayed start

When you select Delayed start the dishwasher will start 1-24 hours after you close the door.

²⁾ The Auto open option is pre-selected for some programs.

1. Press the button once to activate Delayed start. Press the button several times – or hold it in – to set the desired number of hours.
2. Close the door and the dishwasher counts down 1 hour at a time and starts after the selected delay.

If you want to cancel the Delayed start option, open the door and press and hold the main power switch until the display turns off.

Starting the dishwasher

Close the door to start the dishwasher. If the main power switch is on the dishwasher will start automatically when the door is closed.

TIME - Time remaining

Once you have chosen a program and options, the time the program took when last used is displayed.

Status light

The status light on the bottom part of the dishwasher indicates that a program has started.

Flashing light

A flashing light indicates that the door has been opened while a program is in progress. If it flashes when the door is closed, an error has occurred. See the chapter Troubleshooting.

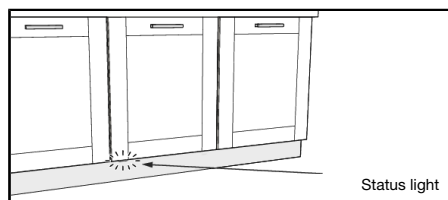

Stopping or changing a program

If you want to change program after starting the dishwasher, open the door then press and hold the main power switch until the display turns off. Add more detergent if the lid of the detergent dispenser has opened. Then press the main power switch, select a new program and close the door.

If you want to load more dishes

Open the door. The dishwasher stops automatically. Add the dishes and close the door. After a while, the dishwasher continues the program.

If the dishwasher is turned off due to a power failure

If the dishwashing program was not finished, the interrupted program continues when power is restored.

NOTE!

During drying, the program is interrupted if the power is cut or the door is open for more than 2 minutes.

Once the program has finished

The end of the program is indicated by one short signal from the buzzer. The chapter Settings describes how to change this function.

Moreover, the end of the program is indicated by the status light turning off. See Status light in the chapter Using the dishwasher.

The dishwasher switches off automatically after the program ends. Shut off the water tap after each use.

How to get the best drying results

- Fully load the dishwasher.
- Angle dishes with hollows, such as cups, so that the rinse water will run off. This is also important for plastic items.
- Top up with rinse aid or increase the rinse aid dosage level.
- Activate the Auto open option.
- Allow the dishes to cool before unloading the dishwasher.

Unloading the dishwasher

Hot porcelain is more fragile. Leave the dishes to cool in the dishwasher before unloading them.

Unload the lower basket first to avoid any water drops from the upper basket falling onto the dishes in the lower basket.

Program chart

PROGRAMS - Program	Detergent, compartment 1 / 2 (ml)	EXTRA - Options	Prewashes	Main wash	Number of rinses	Final rinse	Consumption values ¹⁾		
							Dishwash- ing time (approx. hrs:min)	Energy (approx. kWh)	Water cons. (L)
Eco ²⁾	--- / 25	Auto open	0	55 °C	2	48 °C	3:25	0.85	11
Auto wash	--- / 25	Auto open	1-3	50-65 °C	2-3	65 °C	2:10-2:50	0.9-1.5	10- 20.5
Intensive wash	10 / 25		2	70 °C	2	70 °C	2:55	1.6	17
One hour program	--- / 25	-	-	55 °C	2	65 °C	1:00	0.8	10
Glass	--- / 20	-	-	45 °C	2	50 °C	1:40	0.7	10

¹⁾ Consumption values vary depending on the temperature of the incoming water, room temperature, load size, selected additional functions and more. The values for the Eco program are accurate, others are indicative only.

²⁾ This program is suitable for washing normally dirty dishes and is the most effective program in terms of combined energy and water consumption. This program is used to assess compliance with EU legislation on ecodesign.

Settings

Open the settings menu:

- 1 First, open the door. Turn off the machine. Press and hold the main power switch until the display lights up.
- 2 Within 10 seconds:
 - press the program button for Eco and the option button for SpeedWash.
- 3 The display shows the settings menu (current setting and its currently set value).
(Exit the menu by browsing through the menu or pressing the main power switch.)

eco
55° + 

Navigate the settings menu:

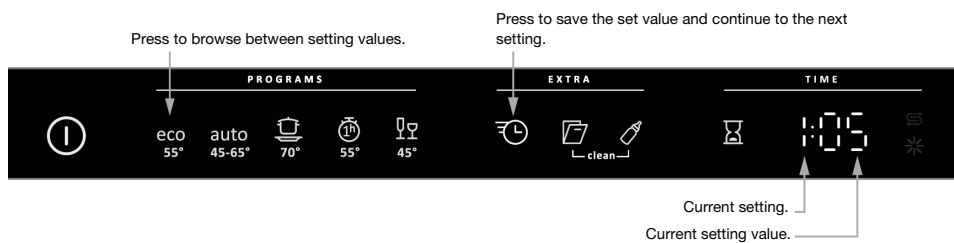

You can now adjust the following settings:

Settings	Options																
1 Rinse aid	1:00 - 1:05	<p>Rinse aid dosage setting.</p> <p>Increase the rinse aid dosage:</p> <ul style="list-style-type: none"> • If the dishes have water marks. <p>Decrease the rinse aid dosage:</p> <ul style="list-style-type: none"> • If the dishes have a sticky white/blue film. • If the dishes are streaked. • Build-up of foam. If you have very soft water, the rinse aid can be diluted 50:50 with water. <p><i>Pre-selected at factory: 05</i></p>															
2 Water hardness	2:00 - 2:09	<p>Adjusting the water softener. Select a setting depending on the hardness of the water supply. It is important that this setting is correct!</p> <table border="1" style="width: 100%; border-collapse: collapse;"> <thead> <tr> <th>German water hardness scale</th> <th>French water hardness scale</th> <th>Recommended setting</th> </tr> </thead> <tbody> <tr> <td>0-5°dH</td> <td>0-9°fH</td> <td>2:00</td> </tr> <tr> <td>6-8°dH</td> <td>10-14°fH</td> <td>2:01</td> </tr> <tr> <td>9-11°dH</td> <td>15-20°fH</td> <td>2:02</td> </tr> <tr> <td>12-14°dH</td> <td>21-25°fH</td> <td>2:03</td> </tr> </tbody> </table>	German water hardness scale	French water hardness scale	Recommended setting	0-5°dH	0-9°fH	2:00	6-8°dH	10-14°fH	2:01	9-11°dH	15-20°fH	2:02	12-14°dH	21-25°fH	2:03
German water hardness scale	French water hardness scale	Recommended setting															
0-5°dH	0-9°fH	2:00															
6-8°dH	10-14°fH	2:01															
9-11°dH	15-20°fH	2:02															
12-14°dH	21-25°fH	2:03															

Table continued from last page

Settings	Options																						
		<p><i>Table continued from last page</i></p> <table border="1" data-bbox="498 188 1020 459"> <thead> <tr> <th data-bbox="498 188 669 248">German water hardness scale</th> <th data-bbox="669 188 844 248">French water hardness scale</th> <th data-bbox="844 188 1020 248">Recommended setting</th> </tr> </thead> <tbody> <tr> <td data-bbox="498 248 669 284">15-19°dH</td> <td data-bbox="669 248 844 284">26-34°fH</td> <td data-bbox="844 248 1020 284">2:04</td> </tr> <tr> <td data-bbox="498 284 669 319">22-24°dH</td> <td data-bbox="669 284 844 319">35-43°fH</td> <td data-bbox="844 284 1020 319">2:05</td> </tr> <tr> <td data-bbox="498 319 669 354">25-29°dH</td> <td data-bbox="669 319 844 354">44-52°fH</td> <td data-bbox="844 319 1020 354">2:06</td> </tr> <tr> <td data-bbox="498 354 669 389">30-39°dH</td> <td data-bbox="669 354 844 389">53-70°fH</td> <td data-bbox="844 354 1020 389">2:07</td> </tr> <tr> <td data-bbox="498 389 669 424">40-49°dH</td> <td data-bbox="669 389 844 424">71-88°fH</td> <td data-bbox="844 389 1020 424">2:08</td> </tr> <tr> <td data-bbox="498 424 669 459">50°dH</td> <td data-bbox="669 424 844 459">89°fH</td> <td data-bbox="844 424 1020 459">2:09</td> </tr> </tbody> </table> <p data-bbox="498 504 1020 667"> Do not forget to put salt in the salt compartment after you have set the water softener to 2:01 - 2:09. <i>For a water supply with a hardness under 6°dH (9°fH), select 2:00. The water softener is deactivated and no salt is needed.</i> <i>Pre-selected at factory: 04</i> </p>	German water hardness scale	French water hardness scale	Recommended setting	15-19°dH	26-34°fH	2:04	22-24°dH	35-43°fH	2:05	25-29°dH	44-52°fH	2:06	30-39°dH	53-70°fH	2:07	40-49°dH	71-88°fH	2:08	50°dH	89°fH	2:09
German water hardness scale	French water hardness scale	Recommended setting																					
15-19°dH	26-34°fH	2:04																					
22-24°dH	35-43°fH	2:05																					
25-29°dH	44-52°fH	2:06																					
30-39°dH	53-70°fH	2:07																					
40-49°dH	71-88°fH	2:08																					
50°dH	89°fH	2:09																					
3 TAB (3-in-1/all-in-one detergent)	3:00 (Off) 3:01 (On)	<p data-bbox="498 673 1020 884"> You can activate this setting when using 3-in-1/ All-in-one detergent. The dishwashing programs automatically adapt to provide the best possible dishwashing and drying results every time. If this setting is activated there is no need to add rinse aid since this option disables rinse aid dispensing. It also reduces the amount of salt added to the water softener. Note that salt must be put in the salt compartment. </p> <p data-bbox="498 884 1020 1043"> In order to achieve good dishwashing results, it is essential to check which type of detergent or all-in-one product best suits your needs! Read the detergent packaging carefully for information on proper use. Always follow the directions for use or information on the detergent packaging! </p>																					
4 Buzzer volume	4:00 - 4:03	<p data-bbox="498 1056 1020 1104"> The dishwasher uses a buzzer to indicate when a program is finished or when a fault has occurred. </p>																					

Care and cleaning

✳ Top up with rinse aid

When the rinse aid needs topping up, the above symbol lights on the display.

After topping up, it may take a while before the symbol goes out.

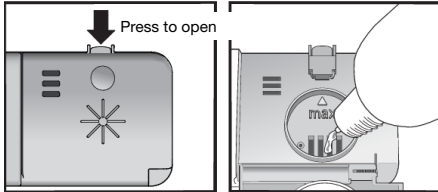

1. Open the rinse aid compartment lid.
2. Carefully top up with rinse aid to the level marked **max**.
3. Wipe up any splashes of rinse aid around the compartment.
4. Close the lid firmly.

⌘ Top up with salt

When the salt needs topping up, the above symbol lights on the display.

After topping up, it may take a while before the symbol goes out.

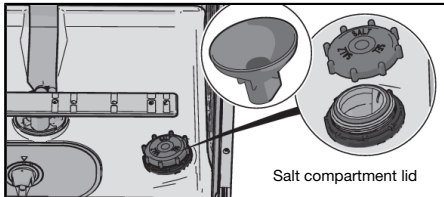

1. Unscrew the salt compartment lid.
2. Place the funnel supplied with the dishwasher in the salt compartment top-up hole. (Water is only needed the first time.)
3. Then add salt, a maximum of 630 gram, until the compartment is full. Use large grain salt or special dishwasher salt.
4. Wipe up any excess salt so that the lid can be screwed on firmly.



WARNING!

In order to avoid rust stains a dishwashing program must be started immediately after adding salt.

Never pour dishwasher detergent into the salt compartment. This destroys the water softener!

Cleaning the filters

Coarse filter

The coarse filter traps larger food particles, which cannot get past the drainage pump. Empty the coarse filter when necessary. It should be cleaned at regular intervals depending on how often the dishwasher is used.

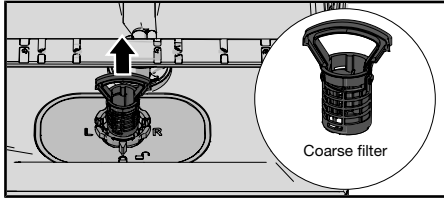

1. Lift the coarse filter by the handle.
2. Empty the coarse filter.
3. Refit the coarse filter. Press it down until it clicks into place.

Fine filter

Debris that collects on the fine filter is automatically rinsed away during each wash. Clean the fine filter when necessary. It should be cleaned at regular intervals depending on how often the dishwasher is used.

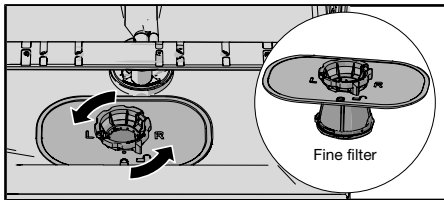

1. Turn the locking ring anticlockwise and lift the fine filter straight up.
2. Clean the fine filter.
3. Refit the fine filter and turn the locking ring clockwise to its stop position. Check that the edges seal properly.

Remember to refit the coarse filter!



NOTE!

Dishwashing results may be affected if the coarse and fine filters are incorrectly fitted. The dishwasher must not be used without the filters in place!



NOTE!

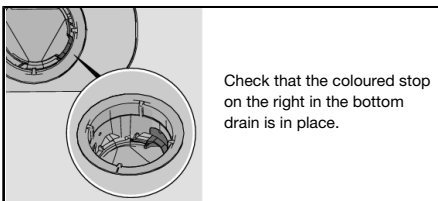

**NOTE!**

Dishwashing results may be affected if the coarse and fine filters are incorrectly fitted. The dishwasher must not be used without the filters in place!

Cleaning the spray arms

Holes and bearings can sometimes become blocked. Remove any debris using a pin or the like. The spray arms also have holes underneath.

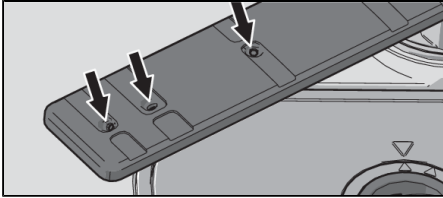

To facilitate cleaning you can remove the spray arms. Remember to fit them firmly back into place afterwards.

Lower spray arm

- Pull the lower spray arm straight up to release it.

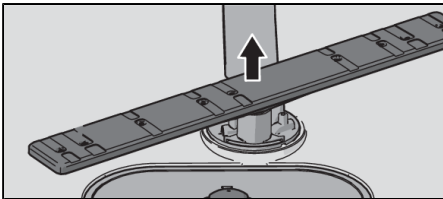

Upper spray arm

1. Pull out the upper basket.
2. Unscrew the spray arm bearings counterclockwise to remove the spray arm from the upper basket.

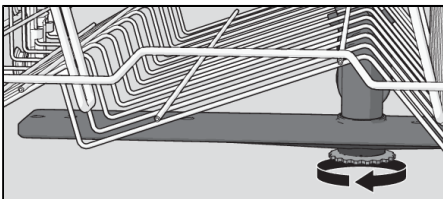

Clean the dishwasher inside and out

Door and door seal

Open the door. Clean the sides of the door and the door seal regularly with a slightly damp cloth. Clean the door seal at the lower front edge of the dishwasher with a washing-up brush.

Display and buttons

Keep the display and the buttons clean. If necessary, wipe them with a dry or slightly damp cloth. Never use cleaning products – they may scratch the surface.

Use the main power switch to switch off the dishwasher when cleaning the buttons to avoid activating them inadvertently.

Dishwasher tub

The dishwasher tub is made of stainless steel and is kept clean through normal use (when used regularly).

If you have hard water, limescale deposits may build up in the dishwasher. If this happens, run the Self-cleaning program program with two tablespoons of citric acid in the detergent compartment (with no dishes in the machine). Special dishwasher cleaners are also available on the market.

Remove blockages

Unblocking the drainage pump

If the dishwasher still contains water after the program has finished, something may be blocking the drainage pump. Such blockages are easily removed.

1. Turn off the machine using the main power switch and unplug it from the wall socket.
2. Remove the coarse filter and the fine filter.
3. Scoop out the water from the dishwasher tub.
4. In order to inspect the drainage pump, remove the coloured stop on the right in the bottom drain.
5. Turn the pump wheel located behind the drainage pump stop by hand. Carefully remove any items.
6. Refit the drainage pump stop along with the fine and coarse filters.
7. Plug the machine in again.

If the dishwasher still does not start and a whirring sound is heard, the overflow protection has been activated.

- Shut off the water.
- Remove the plug from the wall socket.
- Call the service department.

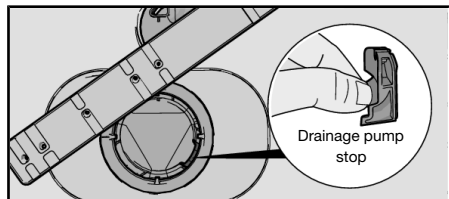

NOTE!

Do not forget to refit the drainage pump stop.

Unblocking the inlet hose filter

If the water supply contains small particles, the outer filter on the inlet hose may become blocked, which results in Water inlet fault.

1. Turn off the machine using the main power switch and unplug it from the wall socket.
2. Turn off the water tap.
3. Unscrew the inlet hose.
4. Carefully remove the outer filter from the inlet hose and clean it.
5. Refit the filter and check that the gasket is correctly positioned.

6. Screw the inlet hose firmly into place.
7. Plug the machine into the wall socket and turn on the water tap. Allow the pressure to settle for a while and check that the connection is watertight.

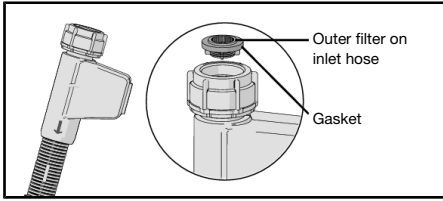

Troubleshooting

Type of fault on the display		Action
F10	Overfilling	Clear the drainage pump. See the chapter Care and cleaning. If the problem persists, call the service department.
F11	Water outlet fault	See “Water remains in the dishwasher” in the table “Problem” below. If the problem persists, call the service department.
F12	Water inlet fault	Check that the water tap is on. Check that the outer filter on the inlet hose is not blocked. See Unblocking the inlet hose filter in the chapter Care and cleaning. If the problem persists, call the service department.
F40	Inlet valve leakage	Turn off the water tap and call the service department.
F52	Water level fault	Clean the coarse and fine filters. Check that the outer filter on the inlet hose is not blocked. If the problem persists, call the service department.
F54	Overfilling	Turn off the water tap and call the service department.
F56	Circulation fault	Call the service department.
F67	Water inlet fault	Check that the water tap is on. Check that the outer filter on the inlet hose is not blocked. See Unblocking the inlet hose filter in the chapter Care and cleaning. If the problem persists, call the service department.

Press any button to clear the error message.

Problem	Possible causes	Action
The buttons do not react when pressed.	You have pressed the buttons too soon after opening the door.	Wait a moment then try again.
	The buttons are dirty.	Clean with a dry or slightly damp cloth.
	The door is closed.	Open the door. The buttons only react to use when the door is open.
Cannot close door.	The baskets are not correctly positioned.	Check that the baskets are correctly positioned horizontally. Check that the dishes are not blocking the baskets from sliding properly into place.
	The door lock does not click into place and lock.	Check the door lock. If it does not click into place and lock, open the door. Press and hold the button for the Auto open option until the button starts flashing. Wait until it stops flashing (60 seconds). Close the door. Check that the door lock clicks into place and locks.

Table continued from last page

Problem	Possible causes	Action
The dishwasher does not start.	The door is not properly closed.	Check.
	You have opened the dishwasher to add more dishes while a program is in progress.	Close the door and wait. After a while, the dishwasher continues the program.
	The door lock has not clicked into place and locked.	Check the door lock. If it does not click into place and lock, open the door. Press and hold the button for the Auto open option until the button starts flashing. Wait until it stops flashing (60 seconds). Close the door. Check that the door lock clicks into place and locks.
	A fuse/circuit breaker has been tripped.	Check.
	The plug is not plugged into the wall socket.	Check.
	The water tap is turned off.	Check.
	Overflow/leaks.	Check.
	A whirring sound (the drainage pump) is heard from the dishwasher and does not stop when the main power switch is turned off.	Turn off the water tap. Pull out the plug and call the service department.
	Check that the Delayed start option has not been selected.	Press and hold the main power switch until the display turns off if you want to cancel the Delayed start option. Restart the dishwasher.
The dishes are not clean.	The spray arms do not rotate.	Remove the arms and clean them.
		Check that the dishes are not blocking the spray arms.
	Spray arm holes or bearings blocked.	Clean the spray arms. See the chapter Care and cleaning.
	Unsuitable dishwashing program.	Select a program with a high temperature to dissolve grease on very dirty dishes, such as Intensive wash.
	Incorrect detergent dosage.	Dose according to water hardness. Far too much or far too little detergent results in poorer dishwashing results.

Table continued from last page

Problem	Possible causes	Action
	Old detergent. Detergent is a perishable product.	Avoid large packages.
	Dishes loaded incorrectly.	Do not cover porcelain with large bowls or the like. Avoid placing very tall glasses in the corners of the baskets.
	Glasses and cups have toppled over during the program.	Place dishes to sit steady.
	The filters are not fitted correctly.	Check that the filter handle is locked in the stop position.
	Drainage pump stop missing.	Check that the coloured stop on the right in the bottom drain is in place. See the chapter Care and cleaning.
Spots on stainless steel or silver.	Some foodstuffs, such as mustard, mayonnaise, lemon, vinegar, salt and dressings, can cause spots on stainless steel if left for too long.	Rinse off these types of foodstuffs if not starting the dishwasher immediately. Consider using the One hour program with the SpeedWash option.
	All stainless steel can cause spots on silver if they come into contact during dishwashing. Aluminium can also cause spots on dishes.	In order to avoid marks and tarnishing, separate dishes made from different metals, such as silver, stainless steel and aluminium.
Spots or films on the dishes.	The water softener is leaking salt.	Check that the salt compartment lid is properly tightened. Otherwise call the service department.
	Incorrect water softener setting.	See the chapter Settings.
	Incorrect rinse aid dosage setting.	See the chapter Settings.
	Salt compartment empty.	Top up with salt. See the chapter Before washing for the first time.
	3-in-1/ All-in-one detergent is used and the setting TAB (3-in-1/ All-in-one detergent) is activated.	Inactivate the setting TAB (3-in-1/ All-in-one detergent) and top up salt and rinse aid.
	Too high temperature and/or too much detergent can cause etching on crystal. Unfortunately, this cannot be repaired, only prevented.	Wash crystal at a low temperature and with a conservative amount of detergent. Contact the detergent manufacturer.

Table continued from last page

Problem	Possible causes	Action
The dishes have a sticky white/blue film.	Rinse aid dosage setting too high.	Reduce the amount. See the sections Before washing for the first time and Settings. If you have very soft water, you may want to dilute the rinse aid 50:50 with water.
Spots left after washing.	Lipstick and tea can be difficult to wash off.	Use a detergent with a bleaching agent.
Detergent residue in the detergent compartment after dishwashing.	The detergent compartment was damp when adding detergent.	The detergent compartment must be dry when adding detergent.
Rattling sound when dishwashing.	The dishes are not correctly placed or the spray arms are not rotating.	Check that the dishes are placed securely. Spin the spray arms to make sure they can rotate.
Water remains in the dishwasher.	The filters are blocked.	Clean the coarse and fine filters.
	The filters are not fitted correctly.	Check that the filter handle is locked in the stop position.
	Debris in the drainage pump.	Clean the drainage pump. See the chapter Care and cleaning.
	Drainage pump stop missing.	Check that the coloured stop on the right in the bottom drain is in place. See the chapter Care and cleaning.
	Kink in drainage hose.	Check that the hose is free from kinks and sharp bends.
	Blocked drainage hose.	Disconnect the drainage hose where it connects to the sink unit's water trap. Check that no debris has fastened and that the connection has an inner diameter of at least 14 mm.
Bad odour in dishwasher.	Dirt around the seals and in corners.	Clean with washing-up brush and low foaming cleaner.
	Low temperature programs have been selected for a prolonged period.	Run a program with a higher temperature about once a month. Or select the self-cleaning program. See Self-cleaning program in the chapter Using the dishwasher.

Table continued from last page

Problem	Possible causes	Action
Grease deposits in the dishwasher.	Low temperature programs have been selected for a prolonged period.	Select a program with a high temperature to dissolve grease on very dirty dishes, such as Intensive wash. Or run a self-cleaning program. See Self-cleaning program in the chapter Using the dishwasher.
The dishes are not dry enough.	The Auto open option is not activated.	Activate the Auto open option.
	The dishwasher is not fully loaded.	Fully load the dishwasher.
	Rinse aid needs topping up or dosage is set too low.	Top up with rinse add or increase the rinse aid dosage. See the sections Before washing for the first time and Settings.
	3-in-1/ All-in-one detergent is used and the setting TAB (3-in-1/ All-in-one detergent) is activated.	Inactivate the setting TAB (3-in-1/ All-in-one detergent) and top up salt and rinse aid.

Installation

[mm]

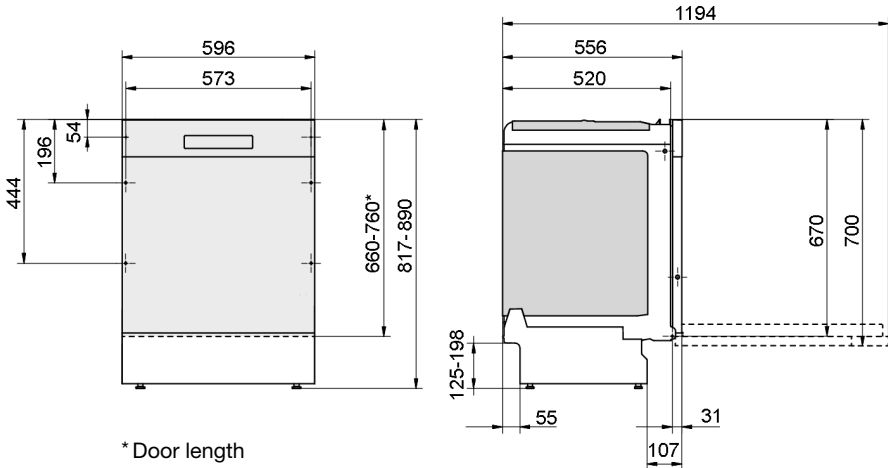

Nominal dimensions. Actual measurements may vary.

It is important that you read through and follow the instructions and directions below. Conduct installation and connection in accordance with the separate installation instructions.

Safety instructions

- Connections to electricity, water and drainage must be performed by a qualified professional.
- Always follow applicable regulations for water, drainage and electricity.
- Take care during installation! Wear protective gloves! There must always be two people!
- Place a drip tray on the floor beneath the dishwasher to prevent damage from any water leaks.
- Before screwing the dishwasher into place, test the dishwasher by running the One hour program with the SpeedWash option. Check that the dishwasher fills with water and drains. Check also that none of the connections leak.

WARNING!

Turn off the water supply when installing the dishwasher!

The plug must be disconnected or power to the socket turned off while the work is carried out!

Setup

- The recess and connection dimensions are included in the separate installation instructions. Check that all dimensions are correct before starting the installation. Note that the height of the cover door can be adjusted to match other fittings.
- Make sure the area on which the dishwasher is to be installed is firm. Adjust the adjustable feet so that the dishwasher is level.
- If the dishwasher is built-in the surrounding furnishings must be resistant to any condensation from the dishwasher.

- Affix the protective film (packed in the document bag) to the underside of the worktop. The protective film is to protect the worktop from moisture.
- Check that the machine is installed such that the door opens freely, otherwise door lock functionality may be disrupted.
- Note that the door springs may need adjusting after a cover door has been fitted. Adjust the left and right door springs equally until the door is evenly balanced.

Drainage connection

See the separate installation instructions for necessary information.

This dishwasher is suitable for installing in a raised recess (to attain an ergonomic working height). This means that the dishwasher can be placed so that the drainage hose runs to a lower level than the bottom of the dishwasher, such as by routing it directly to a floor drain. The dishwasher is fitted with an integrated anti-siphon device to prevent the machine from being emptied of water during the wash cycle.

The drainage hose can also be connected to a connection nipple on the sink unit's water trap. The connection nipple must have an internal diameter of at least 14 mm.

The drainage hose may be extended by a maximum of 3 m (the total length of the drainage hose must not exceed 4.5 m). Any joins and connecting pipes must have an internal diameter of at least 14 mm. However, the drainage hose should ideally be replaced with a new hose without joins.

No part of the drainage hose may be more than 950 mm above the bottom of the dishwasher.

Attach the drainage hose with a hose clamp. Ensure that the drainage hose has no kinks.

Connection to water supply

Use only the inlet hose supplied with the dishwasher. Do not re-use old or other spare hoses.

The supply pipe must be fitted with a water tap (stopcock). The water tap must be easily accessible, so that the water can be shut off if the dishwasher has to be moved.

Once the installation is complete, turn on the water tap and allow the pressure to settle for a while. Check that all connections are watertight.

Connection to cold water supply

Connect the dishwasher to the cold water supply if the building is heated using oil, electricity or gas.

Connection to hot water supply

Connect the dishwasher to the hot water supply (max. 70 °C) if the building is heated using an energy-efficient means such as district heating, solar power or geothermal power. Choosing a hot water connection cuts dishwashing times and reduces the dishwasher's energy consumption.

NOTE!

Do not exceed the permitted water supply temperature. Certain materials used in some cookware cannot withstand strong heat. See Fragile dishes in the chapter Loading the dishwasher.

Electrical connection

Information about the electrical connection can be found on the serial number plate. This specification must match the electricity supply.

The dishwasher must be connected to an earthed socket.

The electric wall socket must be placed outside of the installation area to be easily accessible after installing the dishwasher. Do not use an extension cord!



NOTE!

Electrical cable replacements as well as repairs and maintenance relating to safety or performance must be carried out by the manufacturer's service centre or someone similarly professionally qualified.

Service

Read the chapter Troubleshooting before contacting the service centre. If you have encountered a problem that you cannot resolve, please contact your nearest service centre for professional help, see www.gorenje.com. Our website also has information about spare part availability and what you can repair yourself.

When making contact, provide the details on the serial number plate. Include the article number (1) and the serial number (2).

Please note that non-professional repairs may risk user safety and affect the warranty.

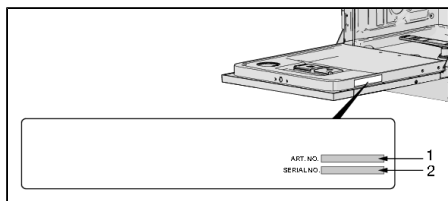

Technical data and energy labelling

Technical data

Height:	817-890 mm
Width:	596 mm
Depth:	556 mm
Weight:	35 kg ¹⁾
Water pressure:	0.03–1.0 MPa
Electrical connection:	See serial number plate
Rated power:	See serial number plate

¹⁾ Weight can vary due to different specifications.

Information for consumers

Information about your product can be found at www.gorenje.com, where you will also find a link to the European Product Database for Energy Labelling, EPREL. Or else visit <https://eprel.ec.europa.eu> directly. Follow the instructions to search by model name.

See the information on the serial number plate. Make a note of the model name (3).

Information for test institute

Information about this product can be found in the European Product Database for Energy Labelling, EPREL, and can also be ordered by e-mail dishwashers@appliance-development.com.

The request should include the details on the serial number plate. Include the article number (1), the serial number (2) and the model name (3).

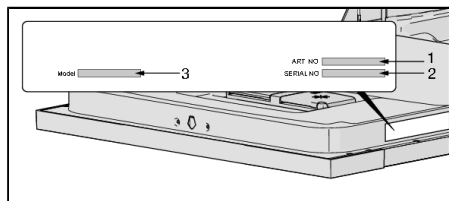

gorenje

GORENJE gospodinjski aparati, d.o.o. • Partizanska 12, 3320 Velenje, Slovenia
Phone: +386 (0)3 899 10 00 • Fax: +386 (0)3 899 28 00 • www.gorenje.com



828712-a3



We reserve the right to make changes.